

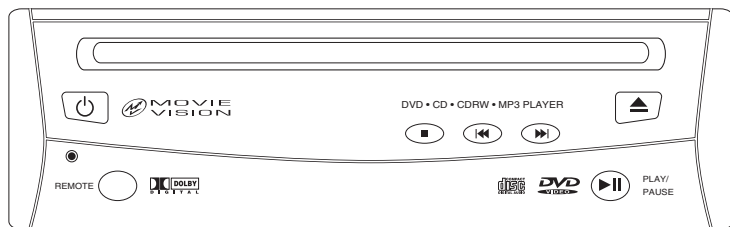

Owner's Manual

Mobile DVD Player



Model: MV-DVD-PL3

For operational or technical assistance, after reading this manual,
please call us toll free at (800) 638-3600.

Features

Compatible with PAL and NTSC Systems

This player can play discs recorded in either PAL or NTSC format.

- A single LSI chip now integrates all major DVD playback circuit functions including MPEG2 decoder, video D/A converter, and audio decoder.

- L/R stereo analog audio outputs for connection to existing head unit aux. inputs. Video output is composite video.
- Supplied Remote Features: multi-language audio-track/subtitle, multi-angle, plus all basic functions.

Use this Product Safely

Driving

Be aware of road and traffic conditions, keep the volume at a low level.

Car Washing

Do not expose the product to water or excessive moisture. This could cause electrical shorts, fire or other damage.

Parking

Parking in direct sunlight can produce very high temperatures inside your vehicle. Give the car interior a chance to cool down before starting playback.

Proper Power Supply

This product is designed to operate with a 12 Volt DC, negative ground battery system.

Protecting the Disc Mechanism

Avoid inserting any foreign objects into the slot of this player. Failure to observe this precaution may cause malfunction of this unit.

Repairs

Contact our customer service representatives. Do not attempt to disassemble or adjust this product yourself.

Installation

The unit should be installed in a horizontal position with the front end up at a convenient angle at not more than 30°.

Contents

Safety Information	3	Multi-Subtitle Language Function . . .	13
Disc Notes	4	Multi-Angle Function	13
Installation	5	MP3 Disc Play	14
Electric Connection	6	Setup	15
DVD Unit Functions	7	Initial Setup	15
Loading and Ejecting a Disc	7	General Setup	15-17
Remote Control	8	Speaker Setup	17
Preparing the Remote Control	8	Audio Setup	17-18
Remote Control Functions	9	Preferences Setup	18-20
Basic Operation	10	Defaults Table	20
On-Screen Display Function	11-12	Specifications	20
Multi-Audio Language Function	13	Troubleshooting	21
Menu Function	13	Replacement Parts	22
Title Menu Function	13	Warranty	23

Safety Information

CAUTION:

MOBILE DVD PLAYER IS A CLASS I LASER PRODUCT. HOWEVER THIS MOBILE DVD PLAYER USES A VISIBLE/INVISIBLE LASER BEAM WHICH COULD CAUSE HAZARDOUS RADIATION EXPOSURE IF DIRECTED. BE SURE TO OPERATE THE MOBILE DVD PLAYER CORRECTLY AS INSTRUCTED. USE OF CONTROLS OR ADJUSTMENTS OR PERFORMANCE OF PROCEDURES OTHER THAN THOSE SPECIFIED HEREIN MAY RESULT IN HAZARDOUS RADIATION EXPOSURE. DO NOT OPEN COVERS AND DO NOT REPAIR YOURSELF. REFER SERVICING TO QUALIFIED PERSONNEL.

WARNING:

- TO REDUCE THE RISK OF FIRE OR ELECTRIC SHOCK, DO NOT EXPOSE THIS EQUIPMENT TO RAIN OR MOISTURE.
- TO REDUCE THE RISK OF FIRE OR ELECTRIC SHOCK, AND ANNOYING INTERFERENCE, USE ONLY THE RECOMMENDED ACCESSORIES.

This product incorporates copyright protection technology that is protected by method claims of certain U.S. patents and other intellectual property rights owned by Magnadyne Corporation and other rights owners. Use of this copyright protection technology must be authorized by Magnadyne Corporation, and is intended for home and other limited viewing uses only unless otherwise authorized by Magnadyne Corporation. Reverse engineering or disassembly is prohibited.

Region Management Information:

This Mobile DVD Player is designed and manufactured to respond to the Region Management Information that is recorded on a DVD disc. If the Region number described on the DVD disc does not correspond to the Region number of this Mobile DVD Player, this Mobile DVD Player cannot play this disc.

Disc Notes

Disc Formats Supported by this Player:

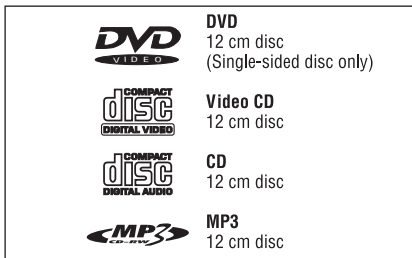

Note: A disc may become somewhat scratched (although not enough to make it unusable) depending on handling and conditions in the usage environment.

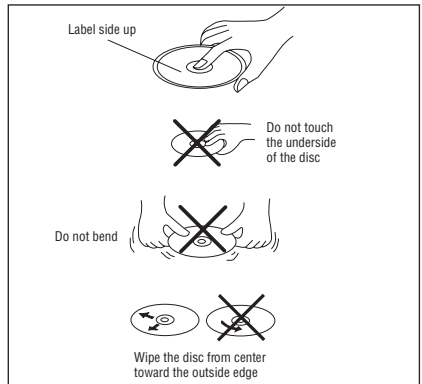

Discs which Cannot be Played with this Player:

- DVD-ROM
- DVD-R/DVD-RAM
- CDV
- CD-G

Handling and Cleaning

- Dirt, dust, scratches and warping disc will cause non operation.
- Do not place stickers on disc or scratch disc.
- Do not warp discs.
- A disc should always be kept in its case when not in use to prevent damage.
- Do not place discs in the following places:
 1. Direct sunlight
 2. Dirty, dusty and damp areas
 3. Near car heaters
 4. Car seats or dashboard

Disc Cleaning

Use a dry soft cloth to wipe the surface. If the disc is quite dirty, use a soft cloth slightly moist with isopropyl (rubbing) alcohol. Never use solvents such as benzine, thinner or conventional record cleaners as they may mar the surface of the disc.

Preparing New Discs with Rough Spots

A new disc may have rough edges on its inside and outside edges. If a disc with rough edges is used, the proper setting will not be performed, and the player will not play the disc. Therefore, remove the rough edges in advance by using a ball point pen or pencil as shown. To do this, press the side of the pen or pencil against the inside and outside edges of the disc.

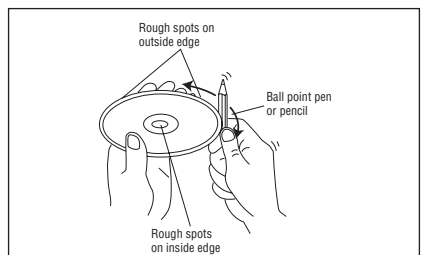

Installation

Note:

1. First remove the two screws that lock the player mechanism (see figure below). Then attach the brackets on both sides of unit with the M4x5 screws. Next, install the unit with the M5x25 screws.
2. When mounting the unit, slide the screws to the left or right side to meet desired position. Select position 1 and 3, or 2 and 4 to mount the bracket.

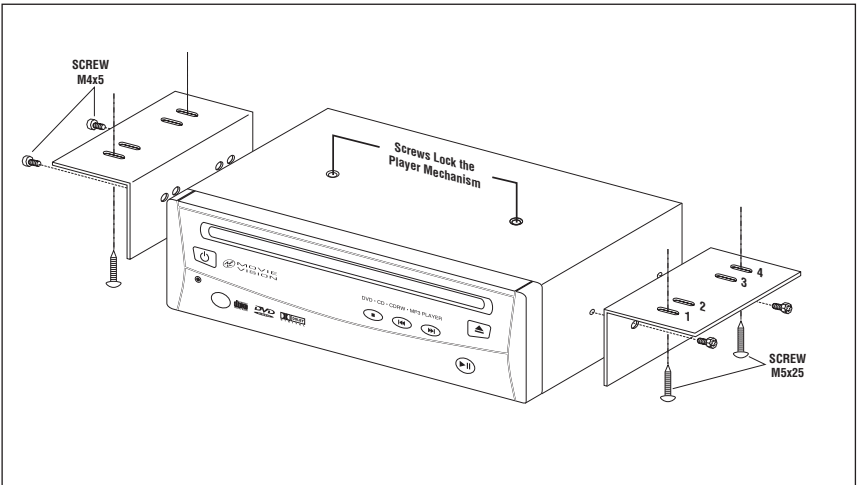
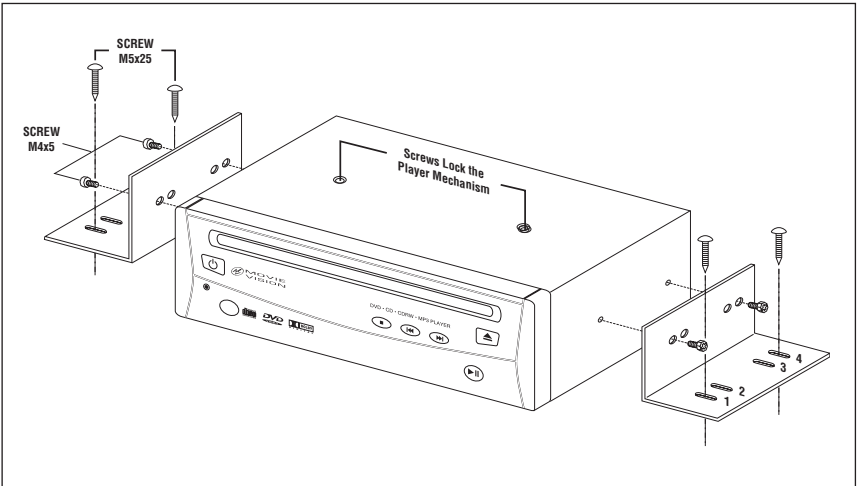

Electric Connection

Connecting to a VCR as an Auxiliary Source

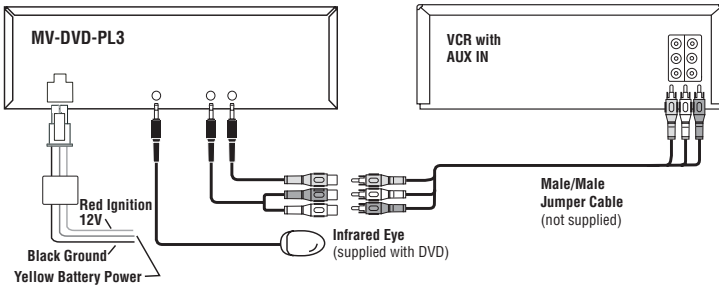

Connecting to a MovieVision Systems as the Only Source

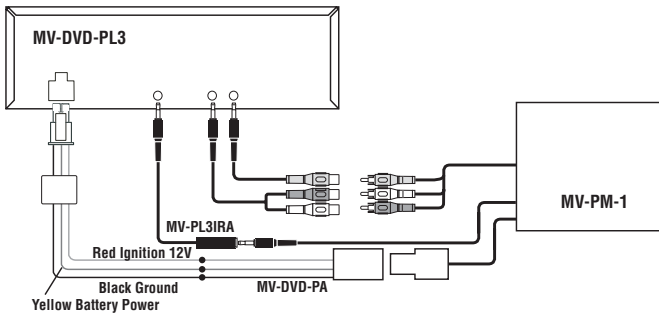

Connecting to a MovieVision System as the Second Source

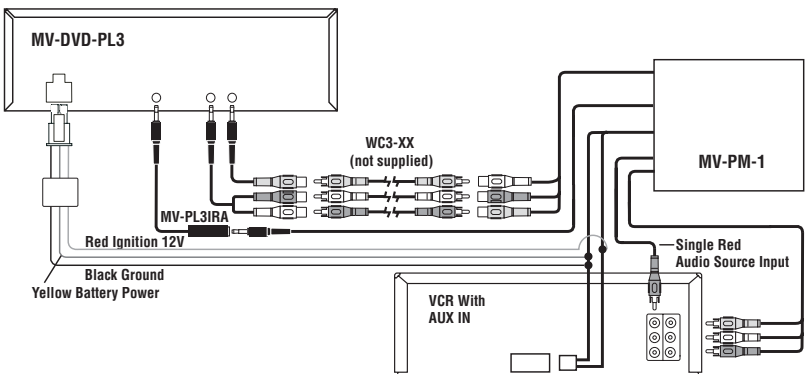

DVD Unit Functions

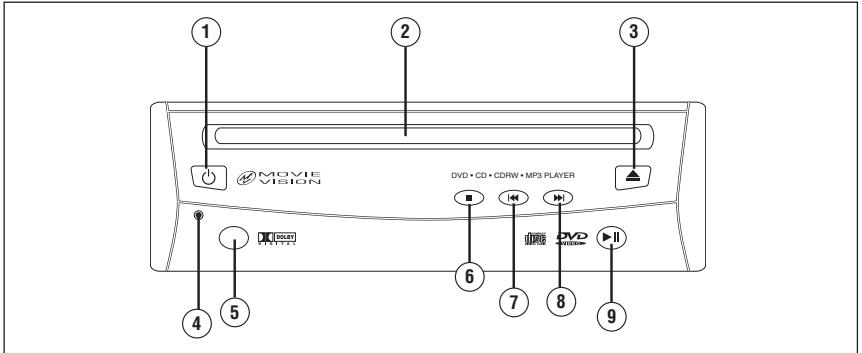

1. **POWER**
2. **DISC SLOT**
3. **EJECT**
4. **RESET**
5. **REMOTE INFRARED SENSOR**
6. **STOP:**
7. **SKIP (PREVIOUS):**
8. **SKIP (NEXT):**
9. **PLAY/PAUSE:**

Loading and Ejecting a Disc

Loading a DVD/VCD/CD Disc

1. Turn the car ignition on to the accessory position.
2. Press the **POWER** button (1).
3. Insert the disc with printed side facing up into the disc slot (2).
4. The player starts playback automatically.

Ejecting a Disc

Press the **EJECT** button (3) to eject the disc.

Remote Control

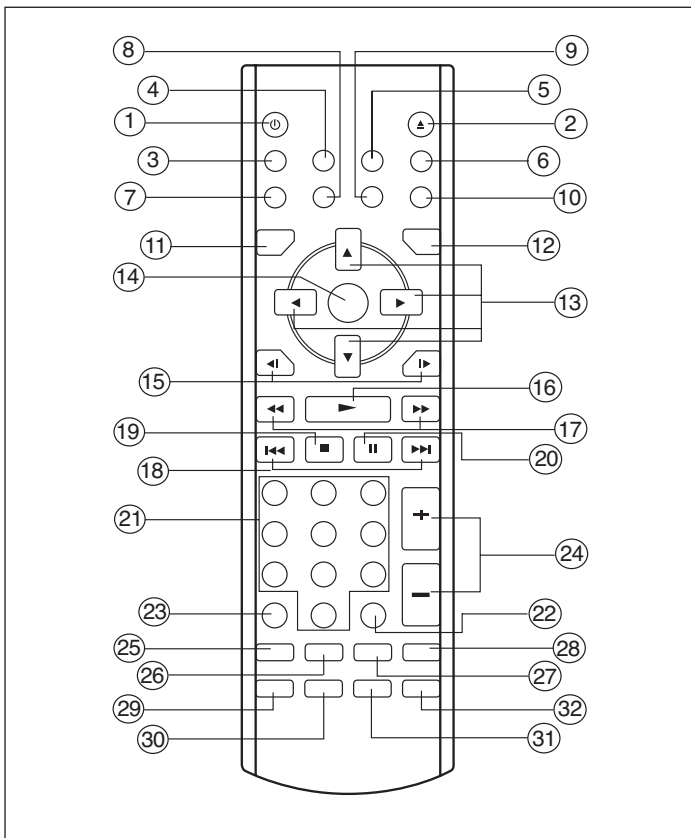

Preparing/Using the Remote Control

Preparing the Remote Control















Inserting the Batteries:

1. Open the battery compartment cover.
2. Insert the two AAA size batteries. Make sure that the positive and negative terminals of the batteries are oriented correctly.
3. Close the battery compartment cover.

Using the Remote Control

Point the remote control towards remote infrared sensor.

Remote Control Functions

- POWER:**  Turns the unit ON or OFF.
- EJECT:**  Ejects the disc.
- MUTE:** Mutes the sound.
- SUBTITLE:** Changes the SUBTITLE language on multi-subtitle language DVD disc.
- ANGLE:** Changes the view angle on multi-angle DVD disc.
- DISPLAY:** Displays statistical disc information during playback.
- PBC:** Changes between PBC ON and PBC OFF on the VCD disc.
- SETUP:** Displays the SETUP menu.
- PAL/NTSC:** Switches between PAL mode and NTSC mode.
- AUDIO:** Changes the AUDIO soundtrack on multi-audio soundtrack DVD disc.
- TITLE:** Displays the TITLE menu that is stored on the DVD disc.
- MENU:** Displays the root menu that is stored on the DVD disc.
- NAVIGATION:** In MENU mode, , , ,  buttons serve as cursor buttons to select item left/right, forward/back.
- ENTER:** Confirms the Track/Chapter selected with the numeric buttons or selected with the cursor buttons on TV screen.
- SLOW FW/RW:** /  Slow FORWARD/REVERSE playback motion.
- PLAY:**  Plays the disc.
- RAPID FW/RW:**  Searches FORWARD rapidly.  REWINDS rapidly.
- SKIP:**  Skips forward one track.  Skips back one track.
- STOP:**  STOPS Play.
- PAUSE:**  PAUSES Play.
- 0-9:** Numeric buttons.
- 10+:** Digital selection button, used in combination with numeric buttons.
- CLEAR:** Clears number when input in error.
- VOLUME:** **VOLUME+/-** Increases or decreases the volume level.
- ZOOM:** Enlarges or reduces size of picture.
- RESUME:** Resumes PLAY when in stop mode.
- GOTO:** Searches disc, used in combination with numeric buttons.
- STEP:** Stops at the next picture.
- RANDOM:** Plays tracks in RANDOM order.
- PROGRAM:** Plays tracks in the order programmed.
- REPEAT:** Switches the REPEAT mode of discs.
- A-B:** Allows a passage to be repeated continuously.

Stopping Play

Press the **■ STOP** button to stop the disk playback. Pressing the **▶ PLAY** button, the disk will continue with normal playback.

Press the **■ STOP** button twice, to stop the playback and go back to initial Track/Chapter.

Rapid Forward/Rapid Reverse

Press **FF ▶▶** and **REW ◀◀** during play. Each time the button is pressed, the speed of rapid forward/reverse changes according to the disc as follows:

DVD/VCD/CD/MP3:

Normal Playback → 2X → 4X → 6X → 8X

Skipping Track

Press **SKIP ◀◀/▶▶** on the remote control or on the front panel during playback. Press **▶▶** to skip to next track, and **◀◀** to go back one track.

Note: For some VCD 2.0 disc (PBC-playback control), may be unavailable.

Slow Motion Play

Press **SLOW ▶/◀** on the remote control during playback. Each time the button is pressed, the slow mode is changed according to the disc as follows:

DVD:

Normal Playback → 2X → 4X → 6X → 8X

Pause (still picture)

Press **PAUSE ||** during playback on the remote handset or **▶||** on the front panel of the DVD unit to stop play temporarily. Press **PLAY ▶** on remote control or **▶||** on the unit to return to normal playback.

Mute

Mutes the sound, while the disc continues playing. When **MUTE** is pressed again, sound will resume at previous level.

Repeat

Press the **REPEAT** button to select repeat mode as follow:

DVD:

→ CHAPTER REPEAT ON → TITLE REPEAT ON → REPEAT OFF →

VCD/CD:

→ REP-ONE → REP-ALL → REPEAT OFF →

1. To continuously repeat the current chapter/track, select REP-ONE mode.
2. To continuously repeat all chapter/tracks on the current disc, select REP-ALL mode.
3. When REPEAT OFF mode is selected, the player will finish playback of the current disc last chapter/track, and will then stop. (REP-ONE and REP-ALL will disappear on the display).
4. REPEAT feature does not support VCD2.0 (with PBC).

A-B

A-B repeat allows a passage to be repeated continuously. Press **A-B** button at the start of the required passage, then press **A-B** button again at the end of the passage. To revert to normal playing, press **A-B** button again. Each time the button is pressed, the screen will display as follows:

→ A TO B SET A → A TO B SET B → A TO B CANCELLED

Disc Search (GOTO)

DVD:

Press **GOTO** button twice. The screen will display the following message:

TITLE 01/01 TIME --:--
00:00:25

You can select the item you want to watch using the **TIME** setting by using the numeric buttons and the **ENTER** button.

VCD (with PBC Off)/CD:

Press **GOTO** button once, the screen will display the following message:

GO TO --:--
00:00:25

Use the numeric buttons to input the time directly.

Zoom

Allows the picture to be increased in size. Press **ZOOM** to toggle between 1.5 scale, 2.0 scale and 3.0 scale.

Random

Press **RANDOM**, track selection will be made in random order. The display screen will show "Shuffle On" on the screen. Press **RANDOM** again, "Shuffle Off" appears and will release mode.

Program

In stop mode, press **PROGRAM**, the screen will display "Program P00:00". For example: press numeric button 4 and **PLAY** ►, "Program P01:04" appears. Track 4 will be played first.

Reset

The **RESET** button is on the front panel of the unit, and must be activated with a ball point pen or thin metal object. This button is to be activated only for the following reasons:

- After the initial wiring installation of the unit is complete.
- All the function buttons are not operating correctly.
- An error symbol is displayed.

Remote Infrared Sensor

Point the remote control at the remote sensor and the unit will then receive the signal.

Turning the Player On/Off

Press the **POWER** button on the front panel or press **POWER** button on the remote control to turn the player On or Off.

On-Screen Display Function

Press the **DISPLAY** button during playback mode to display the contents of the current disc on the screen.

DVD:

1. Press **DISPLAY** for the first time:

TITLE 01/03 CHAPTER 002/025
00:02:25

Title Number, Total Title Number, Chapter Number, Total Chapter Number of this Title on the disc currently being played will be displayed on the screen, along with the elapsed time.

2. Press **DISPLAY** for a second time:

TITLE REMAIN
01:46:58

Basic Operation

3. Press **DISPLAY** for a third time:

CHAPTER ELAPSED
00:00:24

4. Press **DISPLAY** for a fourth time:

CHAPTER REMAIN
00:01:39

5. Press **DISPLAY** for a fifth time and the message on the screen will be cleared.

2. Press **DISPLAY** for a second time:

SINGLE REMAIN
00:03:15

TRACK: 01
TOTAL TRACK:14

3. Press **DISPLAY** for a third time:

TOTAL ELAPSED
00:00:25

TRACK: 01
TOTAL TRACK:14

4. Press **DISPLAY** for a fourth time:

TOTAL REMAIN
00:40:35

TRACK: 01
TOTAL TRACK:14

VCD:

1. Press **DISPLAY** for the first time:

SINGLE ELAPSED
00:00:25

2. Press **DISPLAY** for a second time:

SINGLE REMAIN
00:03:15

3. Press **DISPLAY** for a third time:

TOTAL ELAPSED
00:00:25

4. Press **DISPLAY** for a fourth time:

TOTAL REMAIN
00:40:35

5. Press **DISPLAY** for a fifth time and the message on the screen will be cleared.

MP3:

(When set to NO MENU in SMART NAV item):

1. Press **DISPLAY** for the first time:

CHAPTER ELAPSED 00:00:25

TOTAL TRACK:14
TRACK: 01

2. Press **DISPLAY** for a second time:

CHAPTER REMAIN 00:04:25

TOTAL TRACK:123
TRACK: 01

CD:

1. Press **DISPLAY** for the first time:

SINGLE ELAPSED
00:00:25

TRACK: 01
TOTAL TRACK:14

Multi-Audio Language Function

DVD:

Press **AUDIO** during playback. Each time the button is pressed, the number of the audio soundtrack language changes in sequential order.

Notes:

- The language number is different according to the disc.
- Some discs contain only one language soundtrack.
- When no different language soundtracks are recorded, a  will be displayed at the top left corner.

VCD/CD:

Pressing **AUDIO** during playback makes it possible to switch the sound between Mono and Stereo.

→MONO LEFT→MONO RIGHT→STEREO→

MENU Function

(for DVD only)

Press the **MENU** button while the disc is playing and the disc root menu will be displayed. Navigate with the remote control navigation keys and select a feature by pressing the **ENTER** key.

Title Menu Function

(for DVD only)

If the DVD has multiple titles recorded on the disc, a preferred title can be selected from the title menu to start playback.

1. Press **TITLE** during playback. The title menu is then displayed.
2. Press the cursor buttons to select preferred title and confirm by the **ENTER** key.

Multi-Subtitle Language Function

(For DVD only)

Press **SUBTITLE** during playback. Each time the button is pressed, the number of the subtitle language changes in sequential order.

Notes:

- The language number is different according to the disc.
- Some discs only contain one language soundtrack.
- When no different language soundtracks are recorded, a  will be displayed at screen left top corner.

Multi-Angle Function

(for DVD only)

Press **ANGLE** during playback. Each time the button is pressed, the number of the angle changes in sequential order.

Notes:

- The angle number is different according to the disc.
- The function only works for discs having scenes recorded at different angles.
- A  will be displayed at screen left top corner when no different angles are recorded.

MP3 Disc Play:

MP3 disc is playing as the format of FOLDER.

Example:

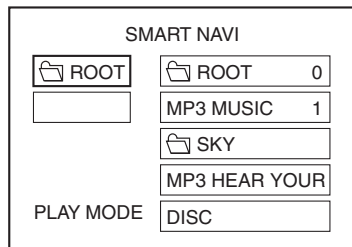

In the playback mode, use **SKIP** ►► or ◀◀ to skip an item ahead or back. ◀◀ **RAPID REW** or ►► **RAPID FWD**.

Note: The FOLDER cannot be selected during play. It can only be selected after the ■ **STOP** button is pressed.

Use ◀/▶, ▲/▼ to select the item or folder, then press the **ENTER** button. Pressing the **REPEAT** button continuously selects from three types of repeat play modes:

REP-ONE:

Plays one song continuously.

FOLDER REP:

Plays all songs in the current directory continuously.

FOLDER:

Plays all songs in the current directory once.

When PLAY MODE is selected, then

◀/▶, ▲/▼ press to change between the following modes:

SINGLE → REP-ONE → FOLDER → FOLDER
REP →

DISC SCAN → **DISC** → DISC REP →
RANDOM →

SHUFFLE ON → PROGRAM PXXX

– INITIAL SETUP –

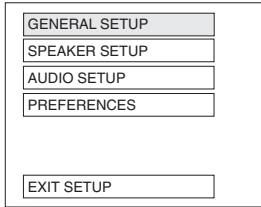

1. Press **SETUP** in the stop mode.
(Press the stop button twice to ensure the player in the STOP mode.)
2. The initial SETUP menu is displayed.
3. Select the preferred item by using the ▲/▼ buttons.
4. Press **ENTER** button.

A. GENERAL SETUP

This setup page includes all the items of TV display and audio output feature.
(Refer to **GENERAL SETUP MENU**)

B. SPEAKER SETUP

This activates the audio output from DOLBY AC3 5.1 DOWNMIX to 2-Channel mode. Please refer to the **SPEAKER SETUP MENU**.

C. AUDIO SETUP

This setup page includes all the items for AUDIO. Please refer to the **AUDIO SETUP MENU**.

D. PREFERENCE SETUP

This setup page includes all the configuration of support feature. Please refer to the **PREFERENCES SETUP MENU**.

– GENERAL SETUP –

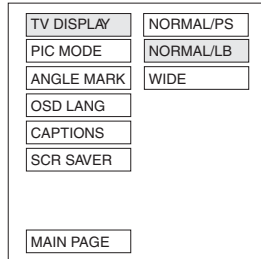

Video Material	TV Screen			
	4:3			
	Normal	Pan Scan	Letter-box	Wide (16:9)
4:3				
16:9				

TV Display Setup

This selects the appropriate TV aspect (4:3 or 16:9) according to the connected TV.

Normal/PS (For 4:3 TV)

Played back in the PAN and SCAN mode.
(If connected to a wide-screen TV, the left and right edges are cut off.)

Normal/LB (For 4:3 TV)

Played back in letter box style.
(If connected to wide-screen TV, black bands will appear at the top and bottom of the screen.)

Wide (For 16:9 TV)

Select when a wide-screen TV is connected.

Setup

– GENERAL SETUP –

TV DISPLAY	
PIC MODE	AUTO
ANGLE MARK	HI-RES
OSD LANG	N-FLICKER
CAPTIONS	
SCR SAVER	
MAIN PAGE	

TV DISPLAY	
PIC MODE	
ANGLE MARK	
OSD LANG	ENGLISH
CAPTIONS	
SCR SAVER	
MAIN PAGE	

PIC Mode Setup

- Select AUTO, the player PIC mode will depend on DVD disc.
- Select HI-RES format for best image resolution.
- Select N-FLICKER mode format if image or picture has noise.

OSD LANG Type Setup

Select the preferred OSD language by using the ▲/▼ buttons

TV DISPLAY	
PIC MODE	
ANGLE MARK	ON
OSD LANG	OFF
CAPTIONS	
SCR SAVER	
MAIN PAGE	

TV DISPLAY	
PIC MODE	
ANGLE MARK	
OSD LANG	
CAPTIONS	ON
SCR SAVER	OFF
MAIN PAGE	

ANGLE MARK Display Setup

When set to ON, while multi-angle DVD disc is playing, the Angle Mark  will appear on the screen. When set to OFF, the mark will not disappear.

CAPTIONS Setup

Activate the CAPTIONS feature by selecting ON. To release this feature select OFF.

– GENERAL SETUP PAGE –

TV DISPLAY	
PIC MODE	
ANGLE MARK	
OSD LANG	
CAPTIONS	ON
SCR SAVER	OFF
MAIN PAGE	

SCR Saver Setup

Select the SCR SAVER output ON or OFF.

– AUDIO SETUP –

AUDIO OUT	ANALOG
OP MODE	SPDIF/RAW
DYNAMIC	SPDIF/PCM
LPCM OUTPUT	
MAIN PAGE	

AUDIO Setup

This activates the audio output from ANALOG mode to SPDIF/RAW mode to SPDIF/PCM mode.

– SPEAKER SETUP –

DOWNMIX	LT/RT
	STEREO
MAIN PAGE	

SPEAKER Setup

This activates the audio output from DOLBY AC3 5.1 DOWNMIX to 2-Channel mode. Select the preferred SPEAKER connection by using the cursor buttons.

- Select LT/RT to activate the Dolby surround compatible output.
- Select STEREO to activate the simple stereo mode.

– AUDIO SETUP –

AUDIO OUT	
OP MODE	LINE OUT
DYNAMIC	RF REMOD
LPCM OUTPUT	
MAIN PAGE	

OP MODE

There are two operating modes for the Dolby Digital decoder: LINE OUT and RF REMOD.

- LINE OUT - with digital dialog normalization. (Recommended)
- RF REMOD - with heavy compression and digital dialog normalization.

– AUDIO SETUP –

AUDIO OUT	
OP MODE	----- FULL
DYNAMIC	----- 6/8
LPCM OUTPUT	----- 4/8
	----- 2/8
	----- OFF
MAIN PAGE	

– PREFERENCES SETUP –

TV TYPE	AUTO
AUDIO	NTSC
SUBTITLE	PAL
DISC MENU	
PARENTAL	
PASSWORD	
DEFAULTS	
SMART NAV	
MAIN PAGE	

DYNAMIC RANGE CONTROL

Select DYNAMIC and adjust the dynamic range of the Dolby Digital encoded program. There are 8 compression steps between FULL and OFF.

TV TYPE Setup

This player can play discs recorded in either PAL or NTSC format. Select NTSC format when connected to NTSC TV. Select PAL format when connected to PAL TV. By selecting AUTO format, the TV output format will be automatically selected by the DVD disc format.

– AUDIO SETUP –

AUDIO OUT	
OP MODE	
DYNAMIC	
LPCM OUTPUT	LPCM 48K
	LPCM 96K
MAIN PAGE	

– PREFERENCES SETUP –

TV TYPE	ENGLISH
AUDIO	FRENCH
SUBTITLE	SPANISH
DISC MENU	CHINESE
PARENTAL	JAPANESE
PASSWORD	
DEFAULTS	
SMART NAV	
MAIN PAGE	

LPCM SETUP

Select the LPCM OUTPUT and then choose between LPCM 48K and LPCM 96K. (LPCM 96K is recommended).

AUDIO LANGUAGE Setup

Select the preferred AUDIO soundtrack by using the CURSOR buttons.

Setup

– PREFERENCES SETUP –

TV TYPE	
AUDIO	
SUBTITLE	ENGLISH
DISC MENU	FRENCH
PARENTAL	SPANISH
PASSWORD	CHINESE
DEFAULTS	JAPANESE
SMART NAV	
MAIN PAGE	

TV TYPE	1 G
AUDIO	2
SUBTITLE	3 PG
DISC MENU	4 PG 13
PARENTAL	5
PASSWORD	6 PG-R
DEFAULTS	7 NC-17
SMART NAV	8 ADULT
MAIN PAGE	NO PARENTAL

SUBTITLE LANGUAGE Setup

Select the preferred SUBTITLE language by using the CURSOR buttons.

PARENTAL

Select suitable parental guidance by using the CURSOR buttons and confirm by pressing ENTER button.

TV TYPE	
AUDIO	
SUBTITLE	
DISC MENU	ENGLISH
PARENTAL	FRENCH
PASSWORD	SPANISH
DEFAULTS	CHINESE
SMART NAV	JAPANESE
MAIN PAGE	

TV TYPE	
AUDIO	
SUBTITLE	
DISC MENU	
PARENTAL	
PASSWORD	CHANGE
DEFAULTS	
SMART NAV	
MAIN PAGE	

DISC MENU LANGUAGE Setup

Select the preferred DISC MENU language by using the CURSOR buttons.

PASSWORD

Select change and press the ENTER button. Type the old password, (factory default password is 3308) then enter a new four character password. Re-enter the new password to confirm.

Setup

– PREFERENCES SETUP –

TV TYPE
AUDIO
SUBTITLE
DISC MENU
PARENTAL
PASSWORD
DEFAULTS
SMART NAV
MAIN PAGE

RESET

DEFAULTS

Select RESET to capture initial factory settings.

– PREFERENCES SETUP –

TV TYPE
AUDIO
SUBTITLE
DISC MENU
PARENTAL
PASSWORD
DEFAULTS
SMART NAV
MAIN PAGE

NO MENU
WITH MENU

SMART NAV

Select between NO MENU mode or WITH MENU mode.

– DEFAULT SETTINGS –

General Setup	TV Display	Normal/PS
	PIC Mode	AUTO
	Angle Mark	ON
	OSD Language	English
	Captions	ON
	SCR Saver	ON
Speaker Setup	Downmix	Stereo
Audio Setup	Audio Out	SPDIF/RAW
	OP Mode	Line Out
	Dynamic	Full
	LPCM Output	LPCM 96K
Preferences	TV Type	AUTO
	Audio	English
	Subtitle	English
	DISC Menu	English
	Parental	No Parental
	Password	3308
	Smart NAV	With Menu

Note: Specifications and designs are subject to modification without notice due to improvements in technology.

Specifications

Supply Voltage	12V DC, Negative Ground
Current Consumption	Less than 2A
Signal System	Composite Video 1.0Vp-p 75Ω
Compatible Discs	(1) DVD-VIDEO Disc, 5" (12cm) Single-Sided Single-Layer, 5" (12cm) Single-Sided Double-Layer, (2) Compact Disc (CD-DA, Video CD), 5" (12cm) Disc
Audio Output Level	2 CH 2.0 Vrms @10kΩ
Characteristics	(1) Frequency Response: 20 Hz - 20 KHz, (2) Signal to Noise Ratio: 80dB (JIS) (3) Wow and Flutter: Below Measurable Limits

Troubleshooting

If it appears that your DVD unit is faulty, first consult this checklist.

Only qualified service personnel can remove the cover or service this player. Otherwise the warranty will become invalid.

No Power:

- Check to see if the player is set to "On".
- Check the power plug of the main unit is properly connected.
- Check that power outlet is properly working.

No Picture:

- Check to see the monitor or TV is switched to "On".
- Select the correct AV input on the monitor or TV.
- Check the video connection.

Distorted Picture:

- Check the disc for fingerprints and clean with soft, dry, cloth, wiping from center to edge.
- A small amount of picture distortion may appear. This may not be a malfunction.

Completely Distorted Picture:

The disc format is not according to the TV used (PAL/NTSC).

No Color in Picture, Distorted or B/W Picture or Distorted Sound from Hi-Fi Amplifier:

The disc format is not according to the TV used (PAL/NTSC).

No Sound:

- Check audio connections.
- If using a Hi-Fi amplifier, try another sound source.

Disc Does Not Play:

- Ensure the disc label is facing upwards.
- Clean the disc.
- Check to see if the disc is defective by trying another disc.

No Return to Start-Up Screen when Disc is Removed:

- Press **POWER** to turn "Off" the unit, then press it again to turn "On" the unit.
- Press **RESET** button "On" the front of the DVD unit.

The Player Does Not Respond to the Remote Control:

- Aim the remote control directly at the sensor on the front of the player.
- Avoid all obstacles which may interfere with the signal path.
- Inspect or replace the remote control batteries.

No Audio at Digital Output:

- Check the digital connections.
- Check the Digital Audio menu to make sure that the digital output is correctly set.
- Check if the audio format of the selected audio language matches your receiver's capabilities.

Buttons Do Not Work:

- Press **POWER** to turn "Off" the unit, then press it again to turn "On" the unit.
- Press **RESET** button on the front of the DVD unit.

Replacement Parts Order Form

Send Orders To: Magnadyne Corporation
 ATTN: Consumer Parts Sales
 P.O. Box 5365
 Carson, CA 90749-5365

We Accept Checks, Money Orders, Visa and Master Card
Make Checks Payable to: Magnadyne Corporation

SHIP TO: (No P.O. Boxes)

LAST NAME

FIRST NAME

INITIAL

STREET ADDRESS (IF PAYING WITH A CREDIT CARD, YOUR BILLING ADDRESS IS REQUIRED)

CITY

STATE

ZIP CODE

DAYTIME PHONE NUMBER

CREDIT CARD INFORMATION:

CARD TYPE: VISA MASTER CARD

CARD NUMBER

EXP. MONTH

YEAR

NAME - EXACTLY AS IT APPEARS ON YOUR CREDIT CARD

Part #	Description	Qty.	Price Each	TOTAL
MV-2000RM	Remote Control		\$39.95	

Shipping and Handling

Subtotal + Tax	Add
Up to \$20.00	\$5.00
20.01 to 30.00	5.95
30.01 to 45.00	6.50
45.01 to 70.00	6.95
Over 70.01	7.95

Subtotal = _____ . _____

California Residents Add Sales Tax = _____ . _____

Shipping and Handling (See Chart) = _____ . _____

TOTAL = _____ . _____

No C.O.D.'s

On regular orders please allow 4-5 weeks for delivery. Please give a shipping address where this order may be delivered between the hours of 9 a.m. and 5 p.m. weekdays. If UPS is unable to deliver, your order will be returned and additional shipping charges will be required.

Replacement Parts for MovieVision® Systems

ORDER BY MAIL	DESCRIPTION	MODEL #	PRICE
	DVD Remote Control	MV2000RM	\$39.95 EA.

Warranty

ONE (1) YEAR LIMITED WARRANTY

Magnadyne Corporation or its authorized agents will within 1 year from the date of sale to you, repair, replace or refund the retail sales price of said product or any part thereof, at the option of the Magnadyne Corporation or its authorized agents, if said product or part is found defective in materials or workmanship, when properly connected and operating on the correct power requirements designated for the specific product. This warranty and Magnadyne Corporation or its authorized agents obligations hereunder do not apply where the product was; damaged while in the possession of the consumer, subjected to unreasonable or unintended use, not reasonably maintained, utilized in commercial or industrial operations, or serviced by anyone other than Magnadyne Corporation or its authorized agents, or where the warning seal on the product is broken or the power and/or plugs are detached from the unit. Magnadyne Corporation or any of its authorized agents will not assume any labor costs for the removal and re-installation of any product found to be defective, or the cost of transportation to Magnadyne Corporation or its authorized agents. Such cost are the sole responsibility of the purchaser.

This warranty does not cover the cabinet appearance items or accessories used in connection with this product, or any damage to recording or recording tape, or any damage to the products resulting from improper installation, alteration, accident, misuse, abuse or acts of nature.

MAGNADYNE CORPORATION OR ITS AUTHORIZED AGENTS SHALL NOT BE LIABLE TO ANYONE FOR CONSEQUENTIAL OR INCIDENTAL DAMAGES OR CLAIMS EXCEPT THOSE ACCORDED BY LAW. NO EXPRESSED WARRANTY OR IMPLIED WARRANTY IS GIVEN EXCEPT THOSE SET FORTH HEREIN. NO IMPLIED WARRANTY SHALL EXTEND BEYOND 1 YEAR FROM THE DATE OF SALE.

This warranty extends only to the original purchaser of the product and is not transferable.

Some states do not allow limitations on how long an implied warranty lasts, and some states do not allow the exclusion or limitation of incidental or consequential damages, so the above limitations or exclusion may not apply to you. This warranty gives you specific legal rights, and you may have other rights that vary from state to state.

Defective merchandise should be returned to the original point of purchase or secondly, to Magnadyne Corporation, 1111 W. Victoria Street, Compton CA 90220. Return Authorization must be obtained before sending, or merchandise may be refused.



Free Manuals Download Website

<http://myh66.com>

<http://usermanuals.us>

<http://www.somanuals.com>

<http://www.4manuals.cc>

<http://www.manual-lib.com>

<http://www.404manual.com>

<http://www.luxmanual.com>

<http://aubethermostatmanual.com>

Golf course search by state

<http://golfingnear.com>

Email search by domain

<http://emailbydomain.com>

Auto manuals search

<http://auto.somanuals.com>

TV manuals search

<http://tv.somanuals.com>