

MAGNASONIC

For Customer Assistance Call:
1-800-287-4871

MMW6103-3

1.0cu.ft. Toaster Oven / Microwave Oven with Rotisserie

Instruction Manual

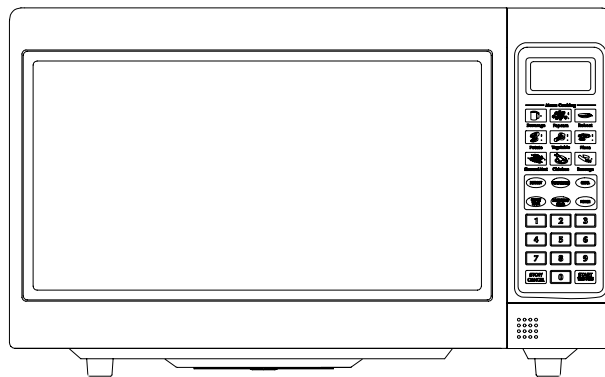

Thank you for your purchase of this Magnasonic product. Please read this Instruction Manual carefully before using product to ensure proper use. Keep this manual in a safe place for future reference.

www.magnasonic.ca

PRECAUTIONS TO AVOID POSSIBLE EXPOSURE TO EXCESSIVE MICROWAVE ENERGY

1. Do not attempt to operate this oven with the door open since open door operation can result in harmful exposure to microwave energy. It is important not to defeat or tamper with the safety interlocks.
2. Do not place any object between the oven front face and the door or allow soil or cleaner residue to accumulate on sealing surfaces.
3. Do not operate the oven if it is damaged. It is particularly important that the oven door closes properly and that there is no damage to the
 - a. Door (bent),
 - b. Hinges and latches (broken or loosened),
 - c. Door seals and sealing surfaces.
4. The oven should not be adjusted or repaired by anyone except properly qualified service personnel.

CONTENTS

PRECAUTIONS	PAGE 2
SPECIFICATIONS	3
BEFORE YOU CALL FOR SERVICE	3
INSTALLATION	3
GROUNDING INSTRUCTIONS	4
RADIO INTERFERENCE	4
IMPORTANT SAFETY INSTRUCTIONS	4
MICROWAVE COOKING PRINCIPLES	5
UTENSILS GUIDE	6
PARTS OVERVIEW	6
CONTROL PANEL	7
HOW TO SET THE OVEN CONTROLS	8
SETTING THE CLOCK	8
MICROWAVE COOKING	8
TOAST / BROIL	8
COMBINATION COOKING	9
ROTISSERIE/COMB.	9
DEFROST	9
COOKING METHODS	10
MENU COOKING SETTINGS	10
OTHER CONVENIENT FEATURES	12
CLEANING AND CARE	13
PRODUCT WARRANTY	14

SPECIFICATIONS

Power Consumption:	120V, 60Hz, 1450W (Microwave)
	1050W (top heater)
	1400W (top and bottom heater)
Rated Microwave Output:	1000W
Operation Frequency:	2450MHz
Outside Dimensions:	305mm(H)×525mm(W)×435mm(D)
Oven Cavity Dimensions:	219mm(H)×350mm(W)×355mm(D)
Oven Capacity:	28Litres
Cooking Uniformity:	Turntable System{Φ284mm}
Net Weight:	17.9kg

*All data subject to change, and verification by the user with data available on the nameplate of the oven.

BEFORE YOU CALL FOR SERVICE

If the oven fails to operate:

1. Check to ensure that the oven is plugged in securely. If it is not, remove the plug from the outlet, wait 10 seconds, and plug it in again making sure that it is plugged in securely.
2. Check for a blown circuit fuse or a tripped main circuit breaker. If these seem to be operating properly, test the outlet with another appliance.
3. Check to ensure that the control panel is programmed correctly and the timer is set.
4. Check to ensure that the door is securely closed engaging the door safety lock system. Otherwise, microwave energy will not flow into the oven.

IF NONE OF THE ABOVE RECTIFIES THE SITUATION, THEN CONTACT OUR CUSTOMER SERVICE DEPARTMENT AT 1800-287-4871 FOR ADVISE/HELP. DO NOT TRY TO ADJUST OR REPAIR THE OVEN YOURSELF.

INSTALLATION

1. Make sure that all the packing materials are removed from the inside of the door.
2. **WARNING:** Check the oven for any damage, such as misaligned or bent door, damaged door seals and sealing surface, broken or loose door hinges and latches and dents inside the cavity or on the door. If there is any damage, do not operate the oven and contact qualified service personnel.
3. This microwave oven must be placed on a flat, stable surface to hold its weight and the heaviest food likely to be cooked in the oven.
4. Do not place the oven where heat, moisture, or high humidity are generated, or near combustible materials.
5. For correct operation, the oven must have sufficient airflow. Allow 20cm of space above the oven, 10cm at back and 5cm at both sides. Do not cover or block any openings on the appliance. Do not remove feet.
6. Do not operate the oven without glass tray, roller support, and shaft in their proper positions.
7. Make sure that the power supply cord is undamaged and does not run under the oven or over any hot or sharp surface.
8. The socket must be readily accessible so that it can be easily unplugged in an emergency.
9. Do not use the oven outdoors.

GROUNDING INSTRUCTIONS

This appliance must be grounded. This oven is equipped with a cord having a grounding wire with a grounding plug. It must be plugged into a wall receptacle that is properly installed and grounded. In the event of an electrical short circuit, grounding reduces risk of electric shock by providing an escape wire for the electric current. It is recommended that a separate circuit serving only the oven be provided. Using a high voltage is dangerous and may result in a fire or other accident causing oven damage.

WARNING Improper use of the grounding plug can result in a risk of electric shock.

1. If you have any questions about the grounding or electrical instructions, consult a qualified electrician or service person.
2. Neither the manufacturer nor the dealer can accept any liability for damage to the oven or personal injury resulting from failure to observe the electrical connection procedures.

RADIO INTERFERENCE

Operation of the microwave oven can cause interference to your radio, TV, cordless phone, or similar equipment.

When there is interference, it may be reduced or eliminated by taking the following measures:

1. Clean door and sealing surface of the oven.
2. Reorient the receiving antenna of radio or television.
3. Relocate the microwave oven with respect to the receiver.
4. Move the microwave oven away from the receiver.
5. Plug the microwave oven into a different outlet so that microwave oven and receiver are on different branch circuits.

IMPORTANT SAFETY INSTRUCTIONS

When using electrical appliance basic safety precautions should be followed, including the following:

WARNING: To reduce the risk of burns, electric shock, fire, injury to persons or exposure to excessive microwave energy:

1. Read all instructions before using the appliance.
2. Use this appliance only for its intended use as described in this manual. Do not use corrosive chemicals or vapors in this appliance. This type of oven is specifically designed to heat, cook or dry food. It is not designed for industrial or laboratory use.
3. Do not operate the oven when empty.
4. Do not operate this appliance if it has a damaged cord or plug, if it is not working properly or if it has been damaged or dropped. If the supply cord is damaged, it must be replaced by the manufacturer, its' service agent or a similarly qualified person in order to avoid a hazard.
5. **Warning:** When the appliance is operated in the combination mode, children should only use the oven under adult supervision due to the temperatures generated.
6. **WARNING:** The rotisserie rack must not be placed in the oven when cooking with microwave.
7. **WARNING:** Only allow children to use the oven without supervision when adequate instructions have been given so that the child is able to use the oven in a safe way and understands the hazards of improper use.
8. To reduce the risk of fire in the oven cavity:
 - d. When heating food in plastic or paper container, keep an eye on the oven due to the possibility of ignition;
 - e. Remove wire twist-ties from paper or plastic bags before placing bag in oven.
 - f. If smoke is observed, switch off or unplug the appliance and keep the door closed in order to stifle any flames.
 - g. Do not use the cavity for storage purposes. Do not leave paper products, cooking utensils or food in the cavity when not in use.

9. **WARNING:** Liquid or other food must not be heated in sealed containers since they are liable to explode.
10. Microwave heating of beverage can result in delayed eruptive boiling, therefore care has to be taken when handling the container.
11. Do not fry food in the oven. Hot oil can damage oven parts and utensils and even result in skin burns.
12. Eggs in their shell and whole hard-boiled eggs should not be heated in microwave ovens since they may explode even after microwave heating has ended.
13. Pierce foods with heavy skins such as potatoes, whole squashes, apples and chestnuts before cooking.
14. The contents of feeding bottles and baby jars should be stirred or shaken and the temperature should be checked before serving in order to avoid burns.
15. Cooking utensils may become hot because of heat transferred from the heated food. Potholders may be needed to handle the utensil.
16. Utensils should be checked to ensure that they are suitable for use in microwave oven.
17. **WARNING:** It is hazardous for anyone other than a trained person to carry out any service or repair operation which involves the removal of any cover which gives protection against exposure to microwave energy.
18. This product is a Group 2 Class B ISM equipment. The definition of Group 2 which contains all ISM (Industrial, Scientific and Medical) equipment in which radio-frequency energy is intentionally generated and/or used in the form of electromagnetic radiation for the treatment of material, and spark erosion equipment. For Class B equipment is equipment suitable for use in domestic establishments and in establishments directly connected to a low voltage power supply network which supplies buildings used for domestic purpose”.

MICROWAVE COOKING PRINCIPLES

1. Arrange food carefully. Place thickest areas towards outside of dish.
2. Watch cooking time. Cook for the shortest amount of time indicated and add more as needed. Food severely overcooked can smoke or ignite.
3. Cover foods while cooking. Covers prevent spattering and help foods to cook evenly.
4. Turn foods over once during microwaving to speed cooking of such foods as chicken and hamburgers. Large items like roasts must be turned over at least once.
5. Rearrange foods such as meatballs halfway through cooking both from top to bottom and from the center of the dish to the outside.

UTENSILS GUIDE

1. The ideal material for a microwave utensil is transparent to microwave, it allows energy to pass through the container and heat the food.
 2. Microwave can not penetrate metal, so metal utensils or dishes with metallic trim should not be used.
 3. Do not use recycled paper products when microwave cooking, as they may contain small metal fragments which may cause sparks and/or fires.
 4. Round /oval dishes rather than square/oblong ones are recommend, as food in corners tends to overcook.
 5. Narrow strips of aluminum foil may be used to prevent overcooking of exposed areas. But be careful don't use too much and keep a distance of 1 inch (2.54cm) between foil and cavity.
- The list below is a guide to help you select the correct utensils:**

Cookware	Microwave	Toast/ Broil	Combination Cooking (page 10)
Heat-Resistant Glass (glass tray)	Yes	Yes	Yes
Non Heat-Resistant Glass	No	No	No
Heat-Resistant Ceramics	Yes	Yes	Yes
Microwave-Safe Plastic Dish	Yes	No	No
Kitchen Paper	Yes	No	No
Metal Tray	No	Yes	No
Metal Rack	No	Yes	No
Aluminum Foil & Foil Container	No	Yes	No
Baking Plate	No	Yes	No
Rotisserie Rack	No	Yes	No

PART NAMES

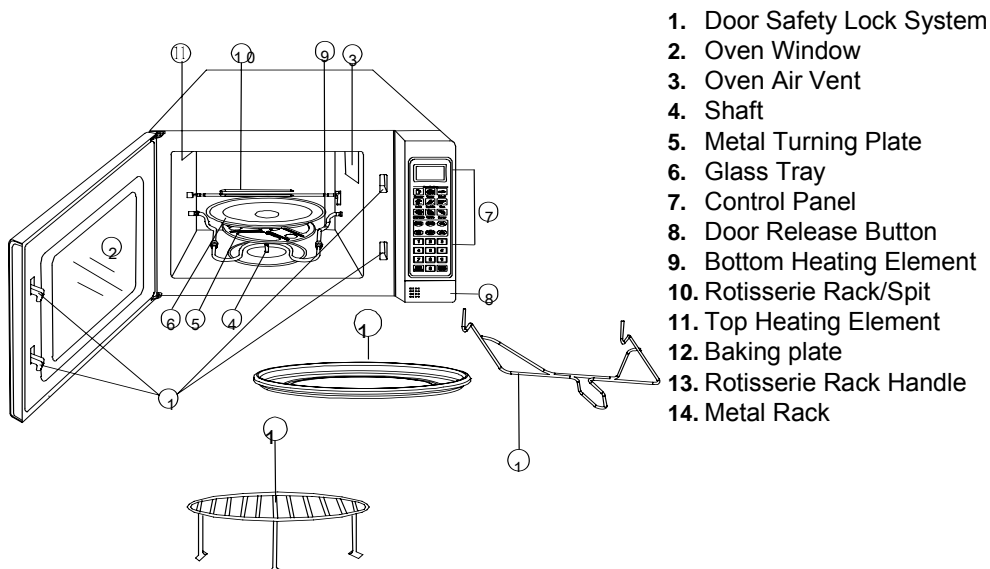

CONTROL PANEL

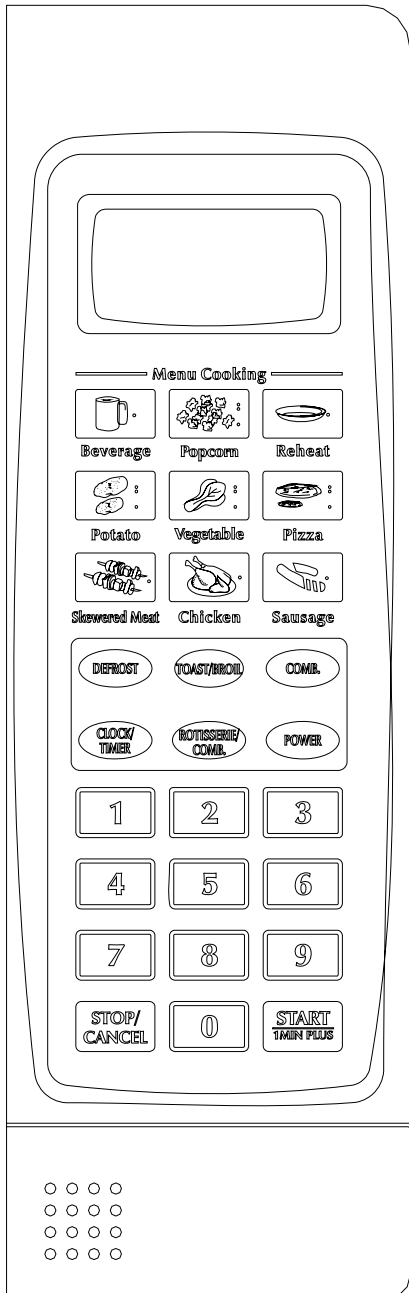

DISPLAY SCREEN

Cooking time, power, indicators and present time are displayed.

POWER

Press to select microwave power level.

TOAST/BROIL

Press to set a TOAST/BROIL-cooking program.

COMB.

Press to select a combination cooking setting.

DEFROST

Touch to defrost food.

CLOCK/TIMER

Use to set the clock time or set a count down timer.

MENU COOKING BUTTONS:

Instant settings to cook popular food types:
BEVERAGE, POPCORN, REHEAT, POTATO, VEGETABLE,
PIZZA, SKEWERED MEAT, CHICKEN, SAUSAGE

START/1 MIN PLUS

Press to start a cooking program or add minutes to cooking time.

NUMERIC PADS

Touch to set the clock or cooking time.

STOP/CANCEL

Touch to stop cooking program or clear all previous settings before cooking starts.

ROTISSERIE/COMB.

Touch to select a cooking mode for uniform cooking.

(Please also see the following pages for more detail)

HOW TO SET THE OVEN CONTROLS

BEEPS DURING OVEN SETTINGS

- ONE BEEP: Oven accepts the entry.
- TWO BEEPS: Oven does not accept the entry. Please check and try again.

SETTING THE CLOCK

The clock works in a 12-hour cycle. When the oven is first plugged in, the display will briefly show "ENTER CLOCK TIME", you can set the clock time now or later. To set the clock time,

1. Press CLOCK/TIMER button once.
2. Use the numeric pads (in the natural sequence of time, i.e. 5 minutes – press '5', then '0', then '0' again) to enter clock time.
3. Press CLOCK/TIMER to confirm the time you entered.

MICROWAVE COOKING

Microwave cooking allows you to customize cooking power and time. First, you select a power level by pressing the POWER button a number of times (see the table below). Then you set the cooking time (maximum 99 min. plus 99 sec.) using the numeric pads, before pushing the START button.

Press POWER button to select cooking power		
Press	Power	Description
Once	100%(P-HI)	High
Twice	90%(P-90)	
3 times	80%(P-80)	
4 times	70%(P-70)	Medium High
5 times	60%(P-60)	
6 times	50%(P-50)	Medium
7 times	40%(P-40)	
8 times	30%(P-30)	Med. Low/Defrost
9 times	20%(P-20)	
10 times	10%(P-10)	Low
11 times	0%(P-00)	

Suppose you want to cook for 5 minutes at 60% power level.

1. Press POWER button 5 times.
2. Press number pads to enter cooking time (press '5', '0', '0') until the correct cooking time (5:00) is displayed.
3. Press START/1MIN PLUS button.

NOTE:

1. If step one is omitted, the default setting is full power.
2. If you want to temporarily stop a cooking session, press the STOP/CANCEL pad once and then you can start the cooking again by pressing START; or press the STOP/CANCEL twice to cancel the cooking program altogether.
3. After the cooking time ends, the system will beep four times and END is displayed. Before starting another cooking session, press STOP/CANCEL pad to clear the display and reset the system.

TOAST/BROIL

Toasting

This function is particularly useful for bread, hot sandwiches, au gratin dishes, thin slices of meat, steaks, chops, kebabs, sausages and pieces of chicken.

Press once	TOAST	Top & bottom grill
Press twice	BROIL (grill)	Top grill only

1. Press TOAST/BROIL pad 1 time for toasting function
2. Use the numeric pads to enter cooking time.
3. Touch START/1MIN PLUS button.

NOTE:

TOAST/BROIL power is set at full power level by the system.

Broiling (grilling)

This function is particularly useful for hot sandwiches, au gratin dishes, steaks, chops, kebabs, sausages and pieces of chicken.

1. Press TOAST/BROIL pad 2 times for broiling function
2. Use the numeric pads to enter cooking time.
3. Touch START/1MIN PLUS button.

NOTE:













TOAST/BROIL power is set at full power level by the system.

COMBINATION COOKING

Combination cooking combines microwave and TOAST/BROIL function to cook food with desired effects. Recommended for fish, potatoes, au gratin, puddings, omelets, baked potatoes, poultry and so on.

Suppose you want to set the oven to combination cooking for 25 minutes.

1. Press COMB. pad up to 4 times to select one of four combination settings.
2. Use the number pads to enter cooking time.
3. Press START/1 MIN PLUS.



Press COMB.	SETTINGS	DISPLAY SHOWS
1	MICRO.  	C-1
2	MICRO.  	C-2
3	MICRO.    	C-3
4	MICRO.    	C-4

- Note that the difference between 'C-1' (combination cooking method # 1) and 'C-2' is as follows: 'C-1' means that 30% of the total time you set, cooking is taking place using microwaves and 70% using broiling method.

'C-2' means that 55% of the total time you set, cooking is taking place using microwaves and 45% using broiling method.

- Note that the difference between 'C-3' and 'C-4' is as follows: 'C-3' means that 30% of the total time you set, cooking is taking place using microwaves and 70% using toasting method.









'C-4' means that 55% of the total time you set, cooking is taking place using microwaves and 45% using toasting method.

- Note that  refers to top heating
- Note that  refers to bottom heating
- During the cooking process you can check what combination cooking setting you are using by pressing the 'COMB.' key once. The cooking setting appears on the display for 3 seconds.

ROTISSERIE/COMB.



The ROTISSERIE feature cooks foods while it's being turned around on the rack (spit) to ensure that it is cooked uniformly.

1. Press ROTISSERIE/COMB. pad up to 3 times to select one of three combination settings.
2. Use the number pads to enter cooking time.
3. Press START/1 MIN PLUS.

Press ROTISS/COMB	SETTINGS	DISPLAY SHOWS
1	 ,  , 	
2	MICRO.  ,  , 	C-1
3	MICRO.  ,  , 	C-2

- Note that the difference between 'C-1' (combination cooking method # 1) and 'C-2' is as follows: 'C-1' means that 30% of the total time you set, cooking is taking place using microwaves and 70% using toasting method.

'C-2' means that 55% of the total time you set, cooking is taking place using microwaves and 45% using toasting method.

- Note that  refers to top heating
- Note that  refers to bottom heating
- Note that  refers to the rotisserie function
- During the cooking process you can check what combination cooking setting you are using by pressing the 'ROTISSERIE/COMB.' key once. The cooking setting appears on the display for 3 seconds.

DEFROST

Suppose you want to defrost frozen food for five minutes.

1. Press DEFROST.
2. Use the number pads to enter defrosting time. In this case, press 5 and double zero.
3. Press START/1MIN PLUS.

COOKING METHODS

Please find below a table detailing what cooking methods we recommend using for some of the most popular food items. The table also shows what accessories (supplied with this product) are to be used for cooking these food types.

Food Type	Microwave	Toast	Broil	Rotisserie	Use These Accessories
Beverages	x				1
Steak		x	x		1 or 3 + 2
Roast		x		x	1,2
Thin Slices of Meat		x	x		1,2
Skewered Meat		x	x		1,2
Sausage		x	x		1,2
Whole Chicken		x		x	1 or 3
Chicken Cutlets	x	x	x		1,2
Fish	x		x		1
Vegetables	x		x		1
Noodles	x				1
Pasta	x				1
Popcorn	x				1
Bread	x		x		1
Toast		x	x		1,2
Sandwich	x	x	x		1
Potatoes	x		x		1
Pizza	x	x	x		1,2

The accessory number refers to the following supplied accessories:

1. Glass Tray, 2. Metal Rack, 3. Baking Plate or 4. Rotisserie Rack

MENU COOKING SETTINGS

“MENU COOKING” allow you to cook or reheat food automatically without entering a power level or time.

BEVERAGE

Press	Weight (Kg)
1	0.2
2	0.4
3	0.6

To reheat beverage, take the following steps:

1. Press BEVERAGE pad once or repeatedly to select weight.
2. Press START/1MIN PLUS pad.

NOTE:

To program the POPCORN time (to customize it to your preference), press POPCORN twice, and use the number pads to enter the new popcorn time, and then press START/1MIN PLUS button to verify. The new popcorn time will remain whenever you use the POPCORN function until you reprogram it using the steps mentioned above.

POPCORN

1. Press POPCORN once, the display will show code and cooking time.
2. Press START/1MIN PLUS button.

REHEAT

Press	Weight (Kg)
1	0.1
2	0.2
3	0.3
4	0.4
5	0.5
6	0.6
7	0.7
8	0.8

To reheat food, take the following steps:

1. Press REHEAT pad once or repeatedly to select weight.
2. Press START/1MIN PLUS button.

POTATO

Press	Weight (Kg)
1	0.15
2	0.3
3	0.45
4	0.6

To cook potato, take the following steps:

1. Touch POTATO pad once or repeatedly to select weight.
2. Press START/1MIN PLUS button.

NOTE:

After the cooking program has finished, let food stand in the oven for 5~10 minutes.

VEGETABLE

Press	Weight (Kg)
1	0.2
2	0.3
3	0.4
4	0.5
5	0.6

To cook vegetable, take the following steps:

1. Touch VEGETABLE pad once or repeatedly to select weight.
2. Press START/1MIN PLUS button.

PIZZA

Press	Weight (Kg)
1	0.1
2	0.2
3	0.3

To cook pizza, take the following steps:

1. Touch PIZZA pad once or repeatedly to select weight.
2. Press START/1MIN PLUS button.

SKEWERED MEAT

Press	Weight (Kg)
1	0.2
2	0.3
3	0.4
4	0.5
5	0.6

To cook skewered meat, take the following steps:

1. Touch SKEWERED MEAT pad once or repeatedly to select weight.
2. Press START/1MIN PLUS button.

CHICKEN

Press	Weight (Kg)
1	0.2
2	0.4
3	0.6
4	0.8

To cook chicken, take the following steps:

1. Touch CHICKEN pad once or repeatedly to select weight.
2. Press START/1MIN PLUS button.

SAUSAGE

Press	Weight (Kg)
1	0.1
2	0.2
3	0.3

To cook sausage, take the following steps:

1. Touch SAUSAGE pad once or repeatedly to select weight.
2. Press START/1MIN PLUS button.

OTHER CONVENIENT FEATURES

MINUTE TIMER

To use the timer feature, when you need to be reminded of either cooking food or something else

1. Press and hold CLOCK/TIMER for 3 seconds.
2. Use the numeric pads to enter the time to be counted down.
3. Press START/1MIN PLUS.

NOTE: When the countdown ends, the system buzzer will sound two long beeps. The maximum time is 99:99. The timer countdown is shown on the display for 3 seconds before the display returns to displaying the clock or cooking time..

CHILD PROOF LOCK

The child proof lock prevents unsupervised operation by little children.

To set the child proof lock: Press STOP/CANCEL button for 3 seconds, then a beep will sound and the indicator light will come on. In the lock state, all buttons are disabled.

To cancel the child proof lock: Press STOP/CANCEL button for three seconds, then a beep will sound and the indicator light will come off.

1MIN PLUS

This pad lets you conveniently add one minute cooking time during cooking with each touch of this button in order for the food to be cooked properly.

TO STOP THE OVEN WHILE THE OVEN IS OPERATING

1. Press STOP/CANCEL button.

You can restart the oven by pressing START/1MIN PLUS pad.

Touch STOP/CANCEL again to erase all instructions.

2. Open the door.

You can restart the oven by closing the door and pressing START/1MIN PLUS pad.

NOTE:

Oven stops operating when door is opened

CLEANING AND CARE

1. Turn off the oven and remove the power plug from the wall socket before cleaning.
2. Keep the inside of the oven clean. When food splatters or spilled liquids adhere to oven walls, wipe with a damp cloth. Mild detergent may be used if the oven gets very dirty. Avoid the use of spray and other harsh cleaners as they may stain, streak or dull the door surface.
3. The outside surfaces should be cleaned with a damp cloth. To prevent damage to the operating parts inside the oven, water should not be allowed to seep into the ventilation openings.
4. Wipe the door and window on both sides, the door seals and adjacent parts frequently with a damp cloth to remove any spills or splatters. Do not use abrasive cleaner.
5. Do not allow the control panel to become wet. Clean with a soft, damp cloth. When cleaning the control panel, leave oven door open to prevent oven from accidentally turning on.
6. If steam accumulates inside or around the outside of the oven door, wipe with a soft cloth. This may occur when the microwave oven is operated under high humidity condition and this is normal.
7. It is occasionally necessary to remove the glass tray for cleaning. Wash the tray in warm sudsy water or in a dishwasher.
8. The roller ring and oven floor should be cleaned regularly to avoid excessive noise. Simply wipe the bottom surface of the oven with mild detergent. The roller ring may be washed in mild sudsy water or dishwasher. When removing the roller ring from cavity floor for cleaning, be sure to put it back in the proper position.
9. Remove odors from your oven by combining a cup of water with the juice and skin of one lemon in a deep microwaveable bowl, microwave for 5 minutes. Wipe cavity thoroughly and dry with a soft cloth.
10. When it becomes necessary to replace the oven light, please consult a dealer to have it replaced.
11. The Rotisserie rack must be cleaned after each use with a damp cloth; a mild detergent may be used if the rack is very dirty
12. **DO NOT** clean the bottom heating element until you have unplugged the product for at least an hour after using it and have made sure that it has completely cooled off. You can remove the metal turning plate by pushing it upwards and thereby moving it off of the shaft. Now you can take the heating element and push it upwards (at the front only) to make it easier to clean. Use a damp cloth and wipe the heating element with a mild detergent or purified water (that doesn't contain minerals). Do not forget to put the metal turning plate back onto the shaft once the heating element is dry.

MAGNASONIC MICROWAVE OVEN WARRANTY

We appreciate your purchase of a MAGNASONIC Microwave. We take pride in the quality of our products and have manufactured your new Microwave unit to exacting quality standards. We feel confident that in normal use, it will provide you with satisfactory performance. However, should you experience difficulty, you are protected under the provisions of this warranty.

MAGNASONIC Microwave Oven are warranted against manufacturing defects in materials and workmanship in normal use for the following periods from the date of purchase by the original user, and is conditional upon the unit being installed and used as directed in the instruction manual.

WARRANTY PERIOD

Domestic Microwave Ovens – Carry-in Service :

One (1) year parts and labour : Seven (7) years on Magnetron – labour not included after initial Twelve (12) months.

MAGNASONIC's obligation under this warranty should be limited to the repair, including all necessary parts and the labour connected therewith, or at our option the exchange of any Microwave Oven which shows evidence of a manufacturing defect within the warranty period. Replacement parts, furnished in connection with this warranty shall be warranted for a period equal to the unexpired portion of the original equipment warranty.

CUSTOMER OBLIGATIONS

This warranty applies to the product from the original date of purchase at retail. Therefore, the owner must provide a copy of the original, dated bill of sale. No warranty service will be performed without a bill of sale. Transportation to and from the service depot is the responsibility of the owner.

WARRANTY EXCLUSIONS

This warranty is extended to MAGNASONIC Microwave Ovens purchased and used in Canada. This warranty shall not apply to appearance or accessory items including but not limited to: glass tray, cabinet, cabinet parts, knobs. This warranty shall, in addition, not apply to damages due to handling, transportation, unpacking, set-up, installation, customer adjustments that are covered in the instruction book, repair or replacement of parts supplied by other than the MAGNASONIC authorized service depot, any malfunction or failure caused by or resulting from abnormal environmental conditions, improper unauthorized service, improper maintenance, modifications or repair by the consumer, abuse, misuse, neglect, accident, fire, flood, or other Acts of God, and incorrect line voltage.

This Appliance product is only warranted to the original retail purchaser. This warranty becomes void in the event of commercial or rental use. This warranty becomes void in the event serial numbers are altered, defaced or removed. MAGNASONIC reserves the right to make changes in design or to make additions to or improvements upon this product without incurring any obligation to install the same on products previously manufactured. The foregoing is in lieu of all other warranties expressed or implied and MAGNASONIC neither assumes nor authorizes any person to assume for it any other obligation or liability in connection with the sale or service of this product. In no event shall MAGNASONIC or its MAGNASONIC dealers be liable for special or consequential damage arising from the use of this product, or for any delay in the performance of this warranty due to cause beyond our control.

The purchaser may have other rights under existing provincial or federal laws, and where any terms of this warranty are prohibited by such laws, they are deemed null and void, but the remainder of the warranty shall remain in effect.

HOW TO OBTAIN SERVICE

Should this product require service, you may obtain specific information on how to obtain service by contacting the MAGNASONIC Dealer from whom this product was purchased, or by contacting us directly:

SONIGEM SERVICE

300 Alden Road

Markham, Ontario

L3R 4C1

PHONE: (905) 940-5089 FAX: (905) 940-2303

TOLL FREE: 1-800-287-4871

Free Manuals Download Website

<http://myh66.com>

<http://usermanuals.us>

<http://www.somanuals.com>

<http://www.4manuals.cc>

<http://www.manual-lib.com>

<http://www.404manual.com>

<http://www.luxmanual.com>

<http://aubethermostatmanual.com>

Golf course search by state

<http://golfingnear.com>

Email search by domain

<http://emailbydomain.com>

Auto manuals search

<http://auto.somanuals.com>

TV manuals search

<http://tv.somanuals.com>