

MDV443 DVD PLAYER



NEED HELP? CALL US!

MAGNAVOX REPRESENTATIVES ARE READY TO HELP YOU WITH ANY QUESTIONS ABOUT YOUR NEW PRODUCT. WE CAN GUIDE YOU THROUGH CONNECTIONS, FIRST-TIME SETUP, AND ANY OF THE FEATURES. WE WANT YOU TO START ENJOYING YOUR NEW PRODUCT RIGHT AWAY.

CALL US BEFORE YOU CONSIDER RETURNING THE PRODUCT.

1-800-705-2000

OR VISIT US ON THE WEB AT WWW.MAGNAVOX.COM

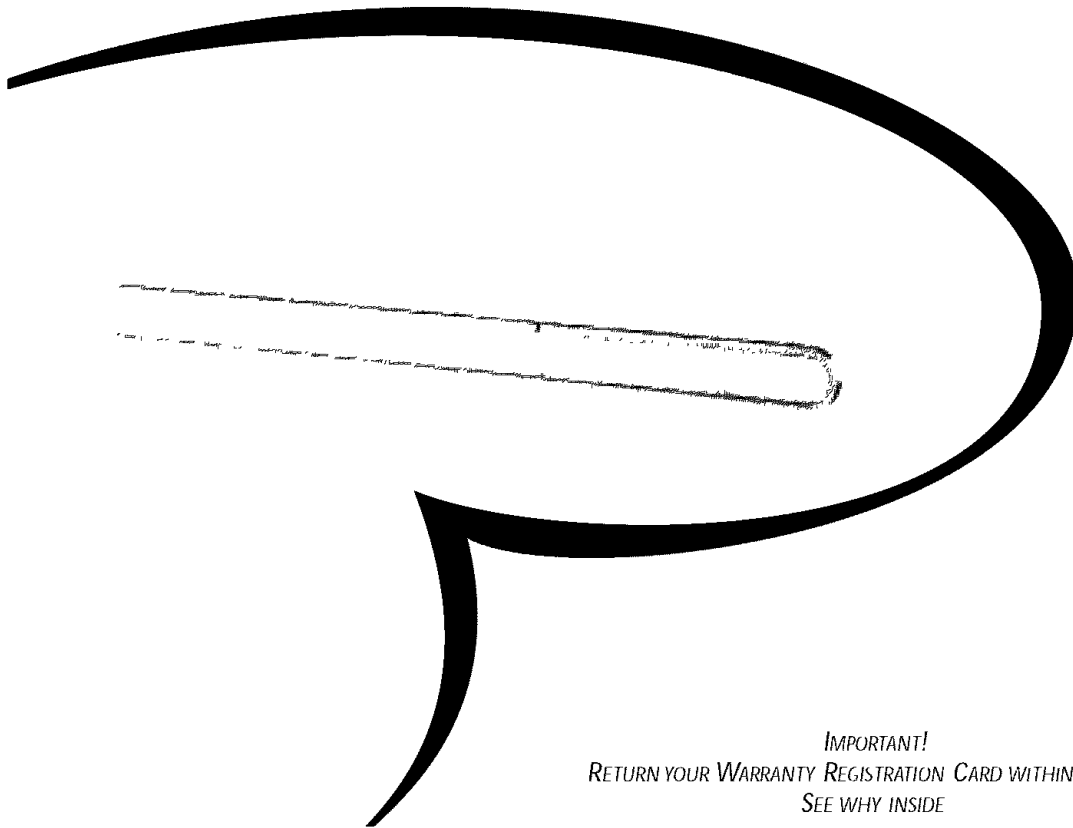

IMPORTANT!
RETURN YOUR WARRANTY REGISTRATION CARD WITHIN 10 DAYS.
SEE WHY INSIDE

Return your Warranty Registration card today to ensure you receive all the benefits you're entitled to.

Once your MAGNAVOX purchase is registered, you're eligible to receive all the privileges of owning a MAGNAVOX product. So complete and return the Warranty Registration Card enclosed with your purchase at once. And take advantage of these important benefits.

Warranty Verification	Owner Confirmation	Model Registration
Registering your product within 10 days confirms your right to maximum protection under the terms and conditions of your MAGNAVOX warranty.	Your completed Warranty Registration Card serves as verification of ownership in the event of product theft or loss.	Returning your Warranty Registration Card right away guarantees you'll receive all the information and special offers which you qualify for as the owner of your model.

Congratulations on your purchase, and welcome to the "family!"



Dear MAGNAVOX product owner:

Thank you for your confidence in MAGNAVOX. You've selected one of the best-built, best-backed products available today. And we'll do everything in our power to keep you happy with your purchase for many years to come.

As a member of the MAGNAVOX "family," you're entitled to protection by one of the most comprehensive warranties and outstanding service networks in the industry.

What's more, your purchase guarantees you'll receive all the information and special offers for which you qualify, plus easy access to accessories from our convenient home shopping network.

And most importantly you can count on our uncompromising commitment to your total satisfaction.

All of this is our way of saying welcome-and thanks for investing in a MAGNAVOX product.

P.S. Remember, to get the most from your MAGNAVOX product, you must return your Warranty Registration Card within 10 days. So please mail it to us right now!

Know these safety symbols



⚡ This "bolt of lightning" indicates uninsulated material within your unit may cause an electrical shock. For the safety of everyone in your household, please do not remove product covering.

⚠ The "exclamation point" calls attention to features for which you should read the enclosed literature closely to prevent operating and maintenance problems.

WARNING: TO PREVENT FIRE OR SHOCK HAZARD, DO NOT EXPOSE THIS EQUIPMENT TO RAIN OR MOISTURE.

CAUTION: To prevent electric shock, match wide blade of plug to wide slot, fully insert.

ATTENTION: Pour éviter les choc électriques, introduire la lame la plus large de la fiche dans la borne correspondante de la prise et pousser jusqu'au fond.

For Customer Use

Enter below the Serial No. which is located on the rear of the cabinet. Retain this information for future reference.

Model No. _____
Serial No. _____

Visit our World Wide Web Site at <http://www.magnavox.com>

General Information

Table of Contents	3
Safety Information	4
Introduction	5
Playable Discs	6

Getting Started

Remote Control Setup	7
Hookups	8-14
Playing a Disc	15
Remote Control Buttons	16-17
Front Panel	18
Rear Panel	19

Disc Playback Features

Menus	20
Paused and Step-by-Step Playback, Resume On	21
Fast Forward/Reverse Search	22
Slow Motion, Zoom	23
Track Playback	24
Title/Chapter Playback, Time Playback	25
Repeat Playback, A-B Repeat Playback	26
Programmed Playback	27
Random Playback	28
MP3/JPEG Playback	29
MP3/JPEG Displays	30
Audio Language, Stereo Sound Mode	31
Subtitle Language, Camera Angles	32

DVD Player Setup and Features

On-Screen Displays	33
Parental Password	34
Parental Levels	35
Marker	36
Audio	37
Display	38-39
Language	40-41
Black Level, Virtual Surround	42

Information You May Need

Care and Maintenance, Glossary	43
Helpful Hints	44
Specifications	45
Limited Warranty	46-47
Index	48

4 Safety Information

Safety Precautions

Warning: To prevent fire or shock hazard, do not expose this equipment to rain or moisture.

Federal Communications Commission (FCC) Warning: Any unauthorized changes or modifications to this equipment void the user's authority to operate it.

Laser Safety

This unit employs a laser. Only a qualified service person should remove the cover or attempt to service this device, due to possible eye injury.

CAUTION: USE OF CONTROLS OR ADJUSTMENTS OR PERFORMANCE OF PROCEDURES OTHER THAN THOSE SPECIFIED HEREIN MAY RESULT IN HAZARDOUS RADIATION EXPOSURE.

CAUTION: VISIBLE AND INVISIBLE LASER RADIATION WHEN OPEN AND INTERLOCK DEFEATED. DO NOT STARE INTO BEAM. THE BEAM IS LOCATED INSIDE, NEAR THE DECK MECHANISM.

Special Information for Canadian Users

This Class B digital apparatus complies with Canadian ICES-003.

Cet appareil numérique de la classe B est conforme à la norme NMB-003 du Canada.

Radio/TV Interference

This equipment has been tested and found to comply with the limits for a Class B digital device, pursuant to Part 15 of the FCC Rules. These limits are designed to provide reasonable protection against harmful interference in a residential installation. This equipment generates, uses, and can radiate radio frequency energy and, if not installed and used in accordance with the instructions, may cause harmful interference to radio communications. However, there is no guarantee that interference will not occur in a particular installation. If this equipment does cause harmful interference to radio or television reception, which can be determined by turning the equipment off and on, the user is encouraged to try to correct the interference by one or more of the following measures:

- 1) Reorient or relocate the receiving antenna.
- 2) Increase the separation between the equipment and the receiver.
- 3) Connect the equipment into an outlet on a circuit different from that to which the receiver is connected.
- 4) Consult the dealer or an experienced radio/TV technician for help.

Copyright Protection

Unauthorized copying, broadcasting, public performance and lending of Discs are prohibited.

This product incorporates copyright protection technology that is protected by method claims of certain U.S. patents and other intellectual property rights owned by Macrovision Corporation and other rights owners. Use of this copyright protection technology must be authorized by Macrovision Corporation and is intended for home and other limited viewing uses only unless otherwise authorized by Macrovision Corporation. Reverse engineering or disassembly is prohibited.

Declaration of Conformity

Model Number: MDV443
Trade Name: Magnavox
Responsible Party: Philips Consumer Electronics
P.O. Box 14810
Knoxville, TN 37914-1810
(865) 521-4316

Manufactured under license from Dolby Laboratories. "Dolby" and the double-D symbol are trademarks of Dolby Laboratories.

Copyright 2003 Magnavox. All rights reserved.

Welcome!

Your new Digital Video Disc Player provides high picture quality, clear sound, and endless playback features available on Digital Video Discs (DVDs). Add options to your DVD viewing - watch a director's cut of a movie, listen to the producer's comments, or play your favorite scene over and over again. The possibilities are limited only by your choices and the materials available on the DVD.

You can listen to Audio Compact Discs and MP3 files on this Player, or view JPEG images.

To get the most enjoyment from the Player, read this owner's manual carefully. It describes how to access the features listed below.

Features

- Audio Language choices *
 - Camera Angles *
 - DVD Menus in a desired language *
 - Markers
 - MP3 Playback
 - Parental control*
 - Paused/Fast/Slow/Step-by-Step Playback
 - Program Playback
 - Random Play
 - Repeat, A-B Repeat
 - Resume On
 - Specific Time/Title/Chapter/Track Playback
 - Subtitles *
 - Zoom
- * If available on the Disc

Disc Menus...

Some explanations in this manual describe the DVD Disc Menus. These menus are set by the movie producers and will vary among Discs. Not all Discs have menus. However, if the Disc has a menu, you can access it by pressing the MENU button on the remote control. *Details are on page 20.*

DVD Player Setup Menus...

Some instructions explain how to use the Player's Setup menu to set features of the DVD Player or the Disc. Access the Setup menu by pressing SETUP on the remote when Disc play is stopped. Even if a feature is set in the Player's menu, it may not be available if the current Disc does not include that feature.

Available Disc Features...



All the features described in this manual may not be available on every Disc. If the feature is not available on the Disc, you cannot use the Player to make the feature available. An "X" will appear in the top right corner of the TV screen if you try to access a feature that is not available on the current Disc or not available at the current time. For example, some features are available only during Disc playback, while others are available only if play is stopped. Try stopping or starting playback, then try the feature again.

6 Playable Discs

Playable Discs

This DVD Player will play Digital Video Discs (DVDs), Audio Compact Discs (CDs), finalized DVD Recordables and DVD Rewritables (DVD+R and DVD+RW), and CD Recordables or CD Rewritables (CD-R or CD-RW).

To play a DVD on this Player, make sure the Disc meets the requirements for Region Codes and Color Systems as described below.

Discs that have the following logos will play on this DVD Player.



DVD



Audio CD



CD-R/CD-RW



DVD+R/DVD+RW

Region Codes

DVDs must be labeled for ALL regions or for Region 1 in order to play on this DVD Player. You can not play DVDs that are labeled for other regions.

Look for the symbols below on your DVDs. If these region symbols do not appear on your DVD, you cannot play the DVD in this Player.



The number inside the globe refers to a region of the world. Region 1 represents the United States, Canada, upper regions of North America, Bermuda, the U.S. Virgin Islands, and small regions near Australia.

A Disc encoded in a specific region format can only play on DVD Players with the same region code. For example, if a Disc is labeled for Region 2, you cannot play the DVD on this Player.

Color Systems

Different color systems are available throughout the world. The most common color systems are NTSC, which is used primarily in the United States and North America, PAL, and SECAM.

This DVD Player uses the NTSC color system. Therefore, the Discs that you play must be recorded in the NTSC system. You cannot play Discs recorded in other formats. The color system of the DVD may be listed on the DVD or on the Disc case.

Unacceptable Discs

If you insert an unacceptable type of disc, "Please insert a playable disc" may appear on the TV screen. The following Discs will not play on this DVD Player.

- CD-ROM
- DVD-RAM
- DVD-ROM
- Super Audio CD (SACD) (The Audio CD layer of a hybrid SACD may play.)
- Compact Disc-Interactive (CD-I)
- Video Single Disc (VSD)
- DVD-Audio

Audio of the following discs might play, but video will not be accessible.

- Compact Disc-Graphic (CD-G)
- Compact Disc-Video (CD-V)

Remote Control Setup 7

Putting Batteries in the Remote Control

- 1** Remove the battery compartment lid on the bottom of the remote control by sliding the lid down and off, following the direction of the arrow on the lid.
- 2** Place two AA batteries inside the battery compartment with their + and - ends aligned as indicated.
- 3** Replace the battery compartment lid.

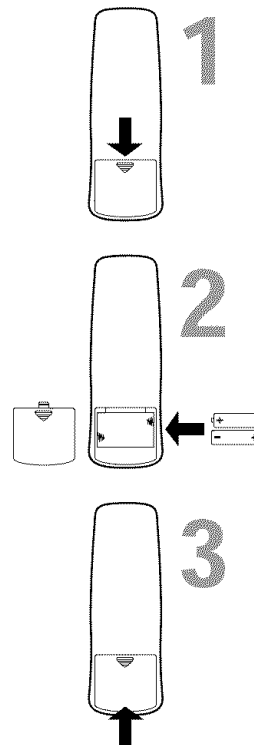

Using the Remote Control

Point the remote control at the DVD Player's remote sensor (see page 18) when using the remote to operate the Player. Do not put objects between the remote and the Player.

Recycling Guidelines/Battery Safety

- Your new product and its packaging contain materials that can be recycled and reused. Specialized companies can recycle your product to increase the amount that needs to be properly disposed. Your product uses batteries that should not be thrown away when depleted but should be disposed of as small chemical waste. Please find out about the local regulations on disposal of your old product, batteries, and packaging whenever you replace existing equipment.
- Battery Usage CAUTION - To prevent battery leakage that may result in bodily injury, property damage, or damage to the unit:
 - Install ALL batteries correctly, with the + and - markings on the battery aligned as indicated on the unit;
 - Do not mix batteries, for example, old with new or carbon with alkaline; and
 - Remove batteries when the unit will not be used for a long time.

8 Hookups

Depending on your TV and other equipment you wish to connect, there are various ways you could connect the DVD Player. Use only one of the connections described in the following pages.

Before you begin...

- Refer to the manuals of your TV, Stereo or other devices as necessary. Note the style of jacks and connectors on the other equipment. Determine how to choose different Audio and Video In channels on your other equipment so you can see and hear the DVD Player on the TV, Stereo, etc.
- Disconnect all equipment from the power outlets. Connect the equipment to the power outlets only after you have finished hooking up everything. Never make or change connections with equipment connected to the power outlet.

Determining the best possible connection...

Your hookup will be determined primarily by your existing equipment, especially your TV. However, the following guidelines describe which options have the best picture and sound quality.

- ★★★★ Component video provides the best picture quality.
- ★★★ S-Video provides excellent picture quality.
- ★★ The yellow Video jack provides good picture quality.
- ★★ **If your TV has a single RF-style jack, usually labelled Antenna In or 75 ohm, you will need an RF adapter in order to connect the DVD Player to the TV.** Ask your electronics retailer for details. The DVD picture still will exceed the quality of videotapes and other analog recordings. *Details are on page nine.*
- ★★★★ Digital audio connections provide the clearest sound. Connect the DVD Player's COAXIAL jack to your Stereo for the best sound.
- ★★★ If digital connections are not possible, connect the DVD Player's red and white AUDIO OUT jacks to the Audio In jacks of your Stereo or TV.

Remember...

- Connect the DVD Player directly to the TV. For example, do not connect the Player to a VCR, then connect the VCR to a TV. This type of connection may distort the picture and sound. Also, your VCR might have the copy protection system, which could further distort the DVD image.
- Set the TV to the correct Video In channel. Such channels may be called AUX or AUXILIARY IN, AUDIO/VIDEO or A/V IN, EXT1 or EXT2 or External In, etc. These channels often are located near channel 00. See your TV owner's manual for details. Or, go to your lowest TV channel (01 or 02) and change channels downward until you see the DVD logo or DVD playback on the TV screen. (The DVD Player must be on.)
If you are using an RF modulator, set the TV to channel 3 or 4.
- Set the Stereo to the correct channel or "source" mode.
- Do not connect the DVD Player's AUDIO OUT jacks to the PHONO IN jack of your Stereo.
- Depending on your connection, you may need to purchase additional cables.
- You only need one audio connection and one video connection.
- If you do not connect the DVD Player to a Dolby Digital-compatible Stereo, set DOLBY DIGITAL to OFF on the DVD Player. *Details are on pages 14 and 37.* Playing a Disc when the settings are wrong could distort the sound or damage the speakers.

Once you determine the best option, find your choice on pages 9-14. Follow the specific steps for the hookup you chose.

Connecting to a TV Only TV has only a single ANTENNA IN or RF-IN jack

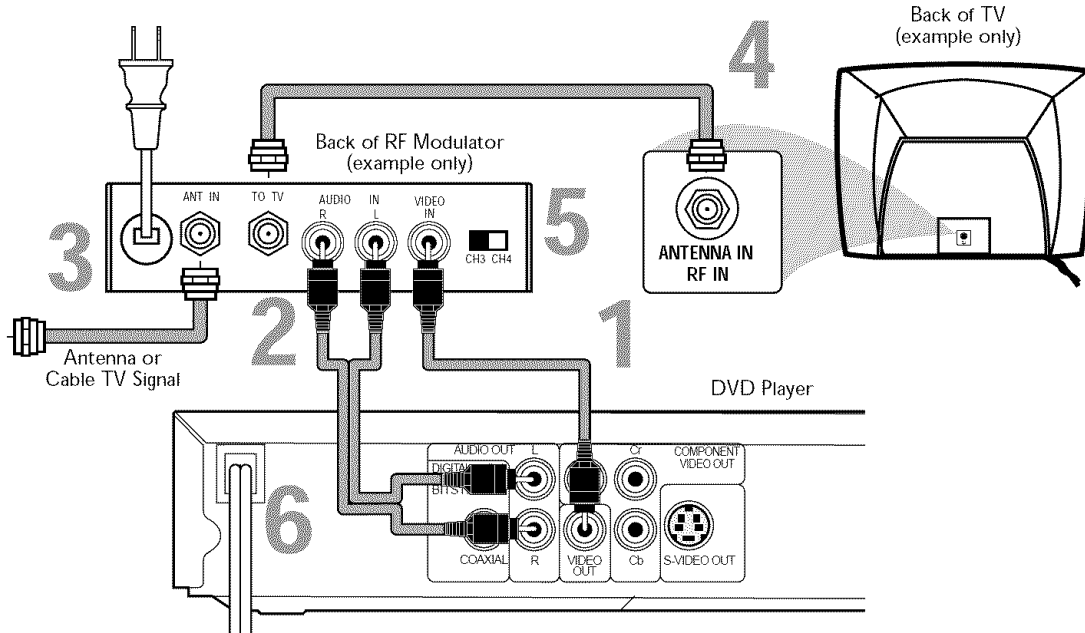

Before you begin, make sure you have an RF modulator and extra RF coaxial cables. These are not supplied with the Player, but are available from Magnavox or most consumer electronics retailers.

- 1** Connect the supplied video cable (yellow) to the Player's yellow VIDEO OUT jack and to the VIDEO IN jack on the RF modulator. The VIDEO IN jack on the RF modulator is usually yellow and might be labelled VIDEO, CVBS, COMPOSITE, or BASEBAND.
 - 2** Connect the supplied audio cable (red and white) to the Player's red and white AUDIO OUT (left and right) jacks. Connect the other ends of the audio cable to the AUDIO IN jacks on the RF modulator. Audio jacks on the RF modulator usually are red (right) and white (left). Match the cable colors to the jack colors.
 - 3** You probably already have an Antenna or Cable TV signal connected to the ANTENNA IN jack on your TV. **Disconnect it now from the TV. Reconnect the Antenna or Cable TV signal to the ANTENNA IN jack on your RF modulator.**
 - 4** Connect an RF coaxial cable (not supplied) to the RF OUT, ANTENNA OUT, or TO TV jack on the RF modulator. The RF OUT jack may be labelled differently among different brands. Refer to the instructions provided with your RF modulator. **Connect the other end of the same RF coaxial cable to the ANTENNA IN or RF IN jack on your Television.**
 - 5** Your RF Modulator should have a Channel 3/4 switch. The setting of this switch determines the TV channel on which you will watch materials playing on the DVD Player. **Set the RF Modulator's Channel 3/4 switch to either 3 or 4, whichever TV channel is least used in your area.** If your RF modulator has a Modulator/Antenna switch, set it accordingly. Refer to the instructions that came with the RF Modulator.
- Turn on your TV and choose channel 3 or 4.** Choose the same channel to which you set the RF Modulator's Channel 3/4 switch.
- 6** Connect the Player's power cord to a power outlet. Press **STANDBY-ON** button to turn on the Player. If no Disc is in the Player, you should see the Player's screen saver on the TV screen.

10 Hookups (cont'd)

Connecting the DVD Player to a TV only TV has AUDIO (red and white) and VIDEO (yellow) IN jacks

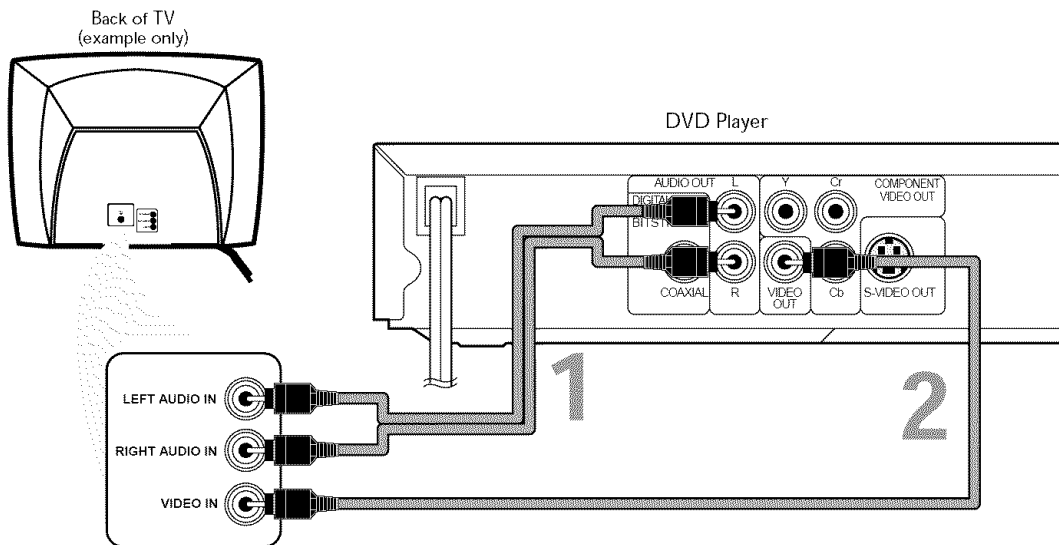

- 1** Connect the supplied red and white audio cables to the red and white AUDIO OUT jacks on the DVD Player and to the red and white AUDIO IN jacks on the TV. Match the cable colors to the jack colors. The right jack is red; the left jack is white.
- 2** Connect the supplied yellow video cable to the VIDEO OUT jack on the DVD Player and to the VIDEO IN jack on the TV.
- 3** Connect the TV's power cord to a power outlet.
Turn on the TV and set it to the Audio/Video In channel.
This channel may be labeled A/V or Audio/Video, Aux or Auxiliary, EXT or External, etc. This channel is usually near channel zero, or your TV's remote control may have a button or switch that lets you select the Video In channel. Or, go to your lowest TV channel (01 or 02) and change channels downward until you find the Video In channel. If you cannot find the Video In channel, check your TV owner's manual.
- 4** Connect the DVD Player's power cord to a power outlet.
Press the STANDBY-ON button to turn on the DVD Player.
You should see the DVD logo on the TV screen. If you do not, check your connections and make sure the TV is set to the correct Audio/Video In channel.

Connecting the DVD Player to a TV only TV has AUDIO (red and white) and S-VIDEO IN jacks

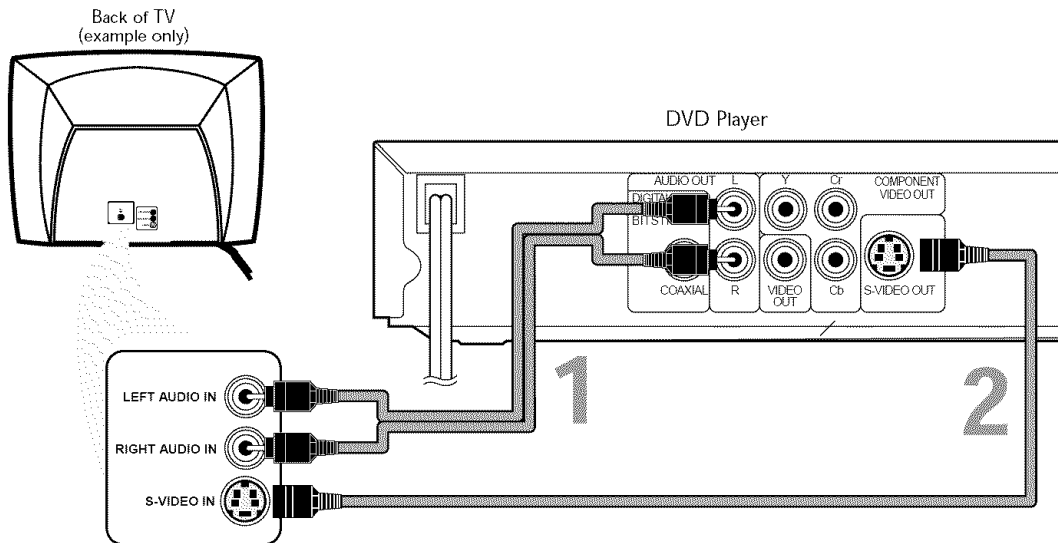

- 1** Connect the supplied red and white audio cables to the red and white AUDIO OUT jacks on the DVD Player and to the red and white AUDIO IN jacks on the TV. Match the cable colors to the jack colors. The right jack is red; the left jack is white.
- 2** Connect an S-Video cable (not supplied) to the S-VIDEO OUT jack on the DVD Player and to the S-VIDEO IN jack on the TV.
- 3** Connect the TV's power cord to a power outlet.
Turn on the TV and set it to the S-VIDEO IN channel.
This channel is usually near channel zero, or your TV's remote control may have a button or switch that lets you select the S-Video In channel. Or, go to your lowest TV channel (01 or 02) and change channels downward until you find the S-Video In channel. If you cannot find the S-Video In channel, check your TV owner's manual.
- 4** Connect the DVD Player's power cord to a power outlet.
Press the STANDBY-ON button to turn on the DVD Player.
You should see the DVD logo on the TV screen. If you do not, check your connections and make sure the TV is on the correct S-Video In channel.

12 Hookups (cont'd)

Connecting to a TV only TV has COMPONENT VIDEO IN Jacks

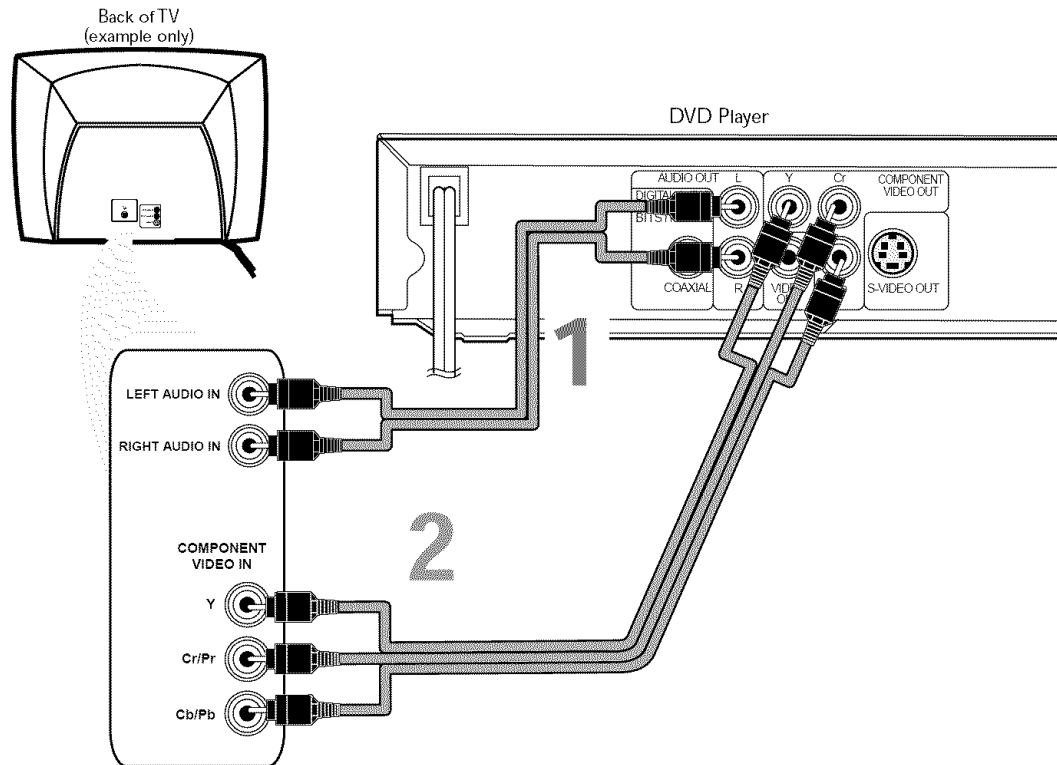

- 1** Connect the supplied red and white audio cables to the red and white AUDIO OUT jacks on the DVD Player and to the red and white AUDIO IN jacks on the TV. Match the cable colors to the jack colors. The right jack is red; the left jack is white.
- 2** Connect component video cables (not supplied) to the COMPONENT VIDEO OUT jacks (Y Cr Cb) on the DVD Player and to the COMPONENT VIDEO IN jacks on the TV. The jacks on the Player are green, red, and blue.
- 3** Plug in the TV's power cord. Turn on the TV and set it to the Component Video In channel, which may be near channel 00. Go to your lowest TV channel (01 or 02) and change channels downward until you find the Component Video In channel. If you cannot find it, check your TV owner's manual. During Audio CD playback, you may check the status of Audio CDs on your TV screen. During DVD playback, you will watch the program on the TV.
- 4** Connect the DVD Player's power cord to a power outlet. Press the STANDBY-ON button to turn on the DVD Player. You should see the DVD logo on the TV screen. If you do not, check your connections and make sure the TV is on the correct Component Video In channel.

Connecting to a TV and a Stereo Stereo has red/white AUDIO IN jacks

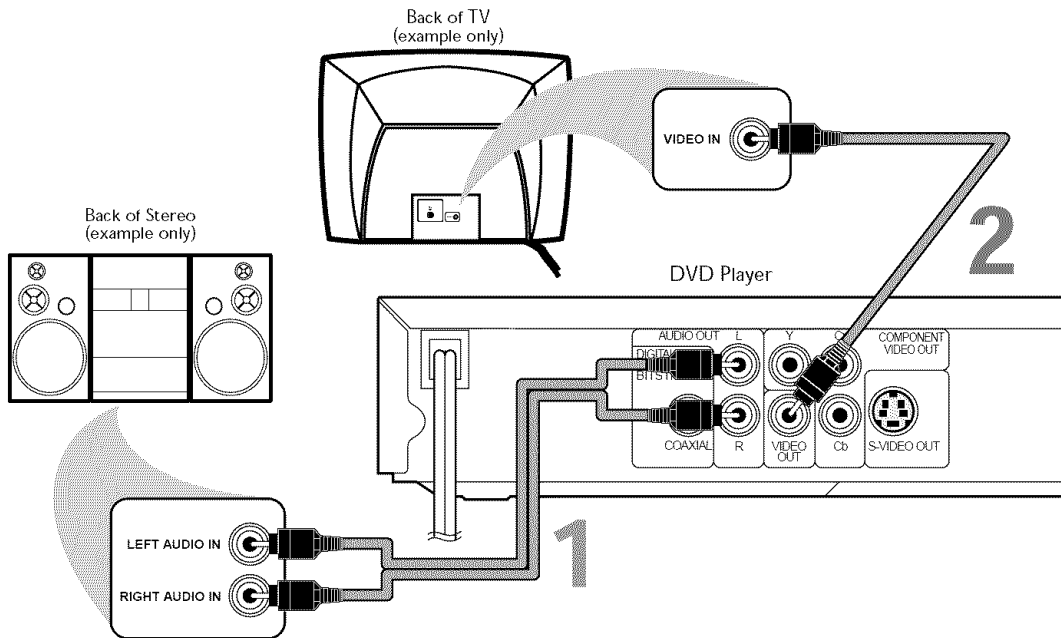

- 1** Connect the supplied red and white audio cables to the Player's red and white AUDIO OUT jacks and to the Stereo's red and white AUDIO IN jacks.

Match the cable colors to the jack colors. The right jack is red; the left jack is white.

- 2** Connect the supplied yellow video cable to the Player's yellow VIDEO OUT jack and to the TV's VIDEO IN jack.

You may use S-Video or Component Video instead. See pages 11-12 for these optional video connections. Remember, you only need one video connection between the TV and the DVD Player.

- 3** Plug in the Stereo's power cord. Turn on the Stereo and select the Auxiliary IN station. During Disc playback, you will adjust the volume at the Stereo. See your Stereo owner's manual for details.

- 4** Plug in the TV's power cord. Turn on the TV and set it to the correct Video In channel. This channel may be labeled A/V or Audio/Video, Aux or Auxiliary, EXT or External, etc. This channel is usually near channel zero, or your TV's remote control may have a button or switch that lets you select the Video In channel. Or, go to your lowest TV channel (01 or 02) and change channels downward until you find the Video In channel. If you cannot find the Video In channel, check your TV owner's manual.

- 5** Connect the Player's power cord to a power outlet. Press STANDBY-ON button to turn on the Player.

You should see the DVD logo on the TV screen. If not, check your connections and set the TV to the correct channel.

14 Hookups (cont'd)

Connecting to a TV and a Stereo with a DIGITAL IN jack

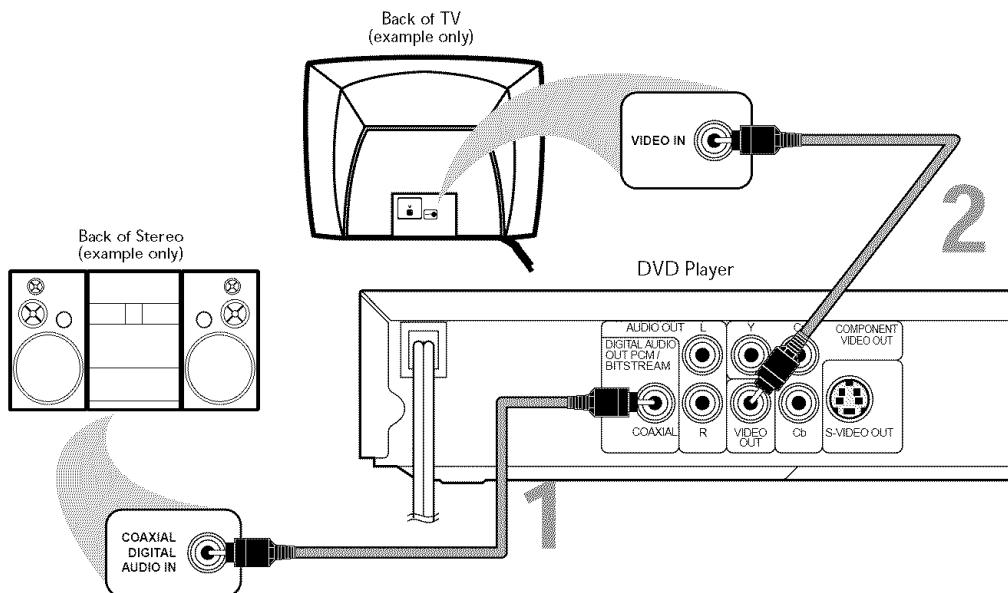

- 1** Connect a coaxial digital audio cable (not supplied) to the Player's COAXIAL jack and to the Stereo's COAXIAL DIGITAL AUDIO IN jack.
- 2** Connect the supplied yellow video cable to the Player's yellow VIDEO OUT jack and to the TV's VIDEO IN jack. You may use S-Video or Component Video instead. See pages 11-12 for these optional video connections. Remember, you only need one video connection between the TV and the DVD Player.
- 3** Plug in the Stereo's power cord. Turn on the Stereo and select the Auxiliary IN station or source mode. During Disc playback, you will adjust the volume at the Stereo. See your Stereo owner's manual for details.
- 4** Plug in the TV's power cord. Turn on the TV and set it to the correct Video In channel. This channel may be labeled A/V or Audio/Video, Aux or Auxiliary, EXT or External, etc. This channel is usually near channel zero, or your TV's remote control may have a button or switch that lets you select the Video In channel. Or, go to your lowest TV channel (01 or 02) and change channels downward until you find the Video In channel. If you cannot find the Video In channel, check your TV manual.
- 5** Plug in the Player's power cord. Press **STANDBY-ON** to turn on the Player. You should see the DVD logo on the TV screen. If you do not, check your connections and make sure the TV is on the correct channel.

Helpful Hints

- Some Discs are recorded in a 5.1 channel Dolby Digital Surround format. These Discs will sound best if you connect the DVD Player to a Stereo that has Dolby Digital.
- Set DOLBY DIGITAL to ON if you connect the Player to a Dolby Digital-compatible Stereo. Details are on page 37.
- Select 5.1 channel Dolby Digital Surround sound if available in the DVD's menu.

Before you begin, turn on the power of the TV, stereo, and any other equipment connected to the DVD Player. Make sure the TV and the stereo (if applicable) are set to the correct channel. *Details are on pages 8-14.*

- 1 Press STANDBY-ON to turn on the DVD Player.** P-ON will appear briefly on the display panel.
- 2 Press OPEN/CLOSE ▲ to open the Disc tray.**
- 3 Place a Disc into the tray.** If the DVD is recorded on only one side, place the Disc in the tray with the label facing up and the shiny side facing down. Some DVDs are recorded on both sides. Make sure the label of the side you want to play is facing up.

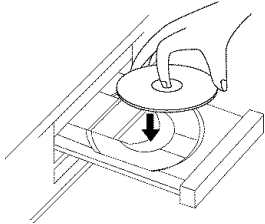

- 4 Press Play ► to close the tray.** The tray will close and play will begin at the first Chapter or Track. If a DVD menu appears instead, see page 20. With some Audio CDs, playback will not begin unless you press Play ► again. With MP3 and JPEG files, play will begin at Track 1 or when you select an item and press Play ►. *Details are on page 29.* You also can close the tray by pressing OPEN/CLOSE ▲.

- 5 Press Stop ■ to stop playback.**

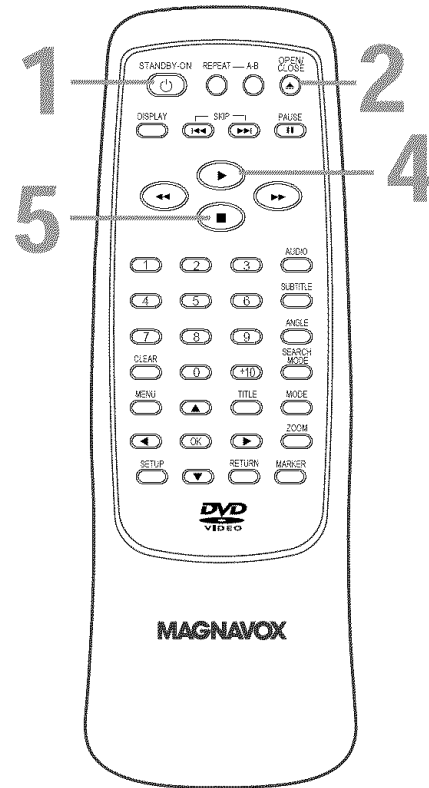

Helpful Hints

- An "X" may appear in the top right corner of the TV screen when you try a feature. This means either the feature you tried is not available on the Disc, or the Player cannot access the feature at this time. This does not indicate a problem with the Player.
- If a Disc is dirty or has scratches, the pictures may appear distorted and play may stop. In such cases, remove the Disc and turn off the Player. Unplug the power cord, then reconnect it to the power outlet. Clean the Disc, then turn on the Player again and reinsert the Disc for playback.
- If a Disc has multiple layers, the picture may freeze occasionally. This happens when the first layer switches to the second layer. This is not a malfunction.

Remember, this DVD Player will play only certain Discs. See page six for details.

16 Remote Control Buttons

STANDBY-ON Button
Press to turn the power on and off. P-ON or P-OFF appears briefly on the display panel.

SKIP ►► and ◄◄ Buttons
Press to skip Chapters or Tracks.
Details are on page 24.

Play ► Button
Press to begin Disc play.

Reverse ◄◄ Button
Press to view the picture in fast reverse motion (DVD) or to reverse play of an Audio CD or MP3 Track. *Details are on page 22.*

Stop ■ Button
Press to stop Disc play.

MENU Button
Press to display the Disc menu.
Details are on pages 5 and 20.

Arrow Buttons
Press to select an item in the DVD Player's Setup menu or in the Disc menu.

SETUP Button
When Disc playback is stopped, press to access or remove the DVD Player's Setup menu.

OK Button
Press to select, change, or confirm a setting in the DVD Player's Setup menu.
Press to select a feature in the DVD Disc menu.

OPEN/CLOSE ▲ Button
Press to open or close the Disc tray.

Pause || Button
Press to pause Disc playback. Press repeatedly to advance the DVD picture step by step (or one frame at a time).
Details are on page 21.

Fast Forward ►► Button
Press to fast forward the Disc.
Details are on page 22.
On a DVD, press Pause ||, then press Fast Forward ►► to begin slow motion playback.
Details are on page 23.

TITLE Button
Press to display the Title menu of the DVD, if available.
Details are on page 20.

ZOOM Button
Press to enlarge the DVD picture or JPEG image.
Details are on page 23.

RETURN Button
Press to return to the previous DVD Player Setup menu or to remove the Setup menu. Press to remove displays. *Details are on page 33.*

Remote Control Buttons (cont'd) 17

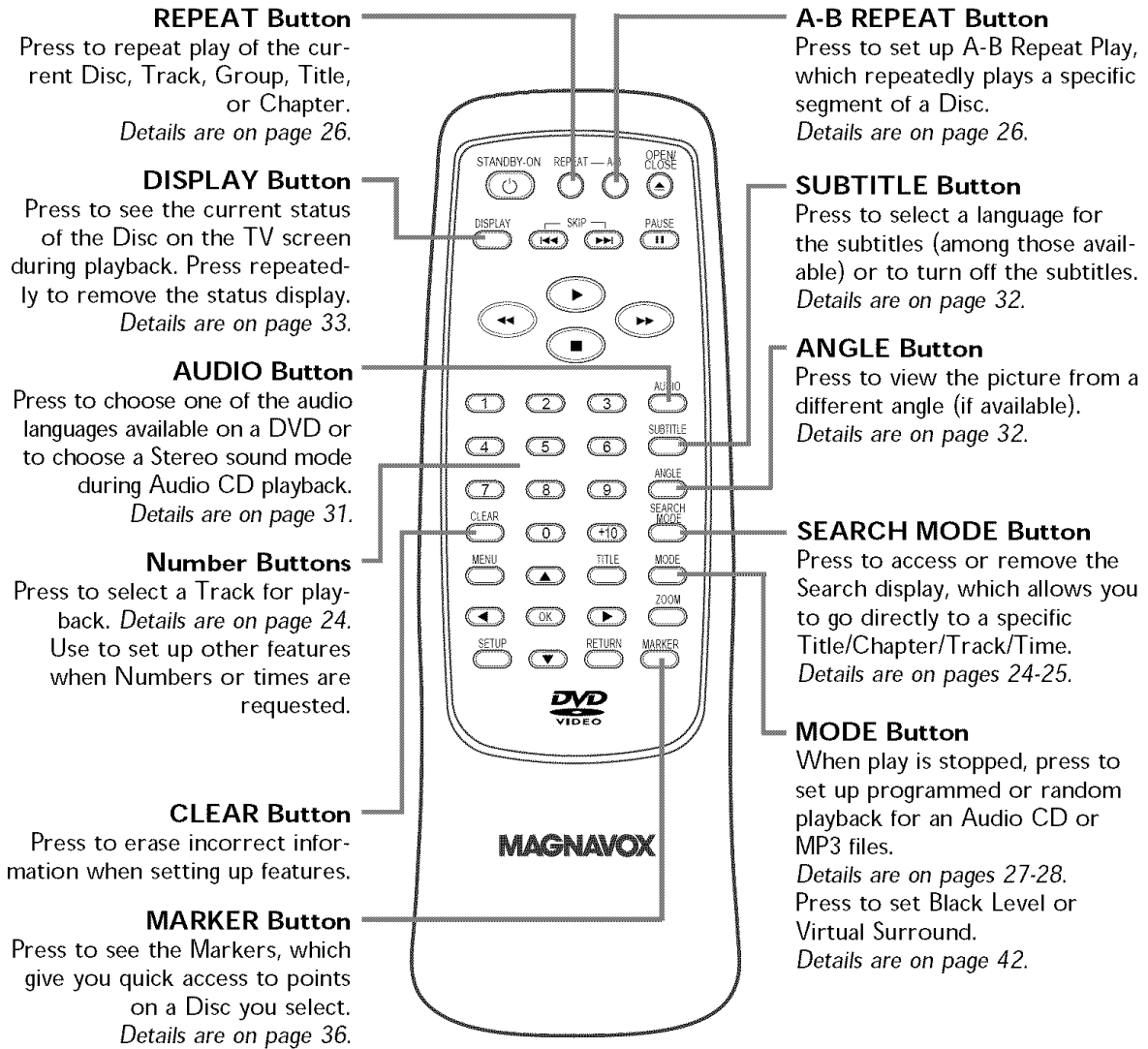

18 Front Panel

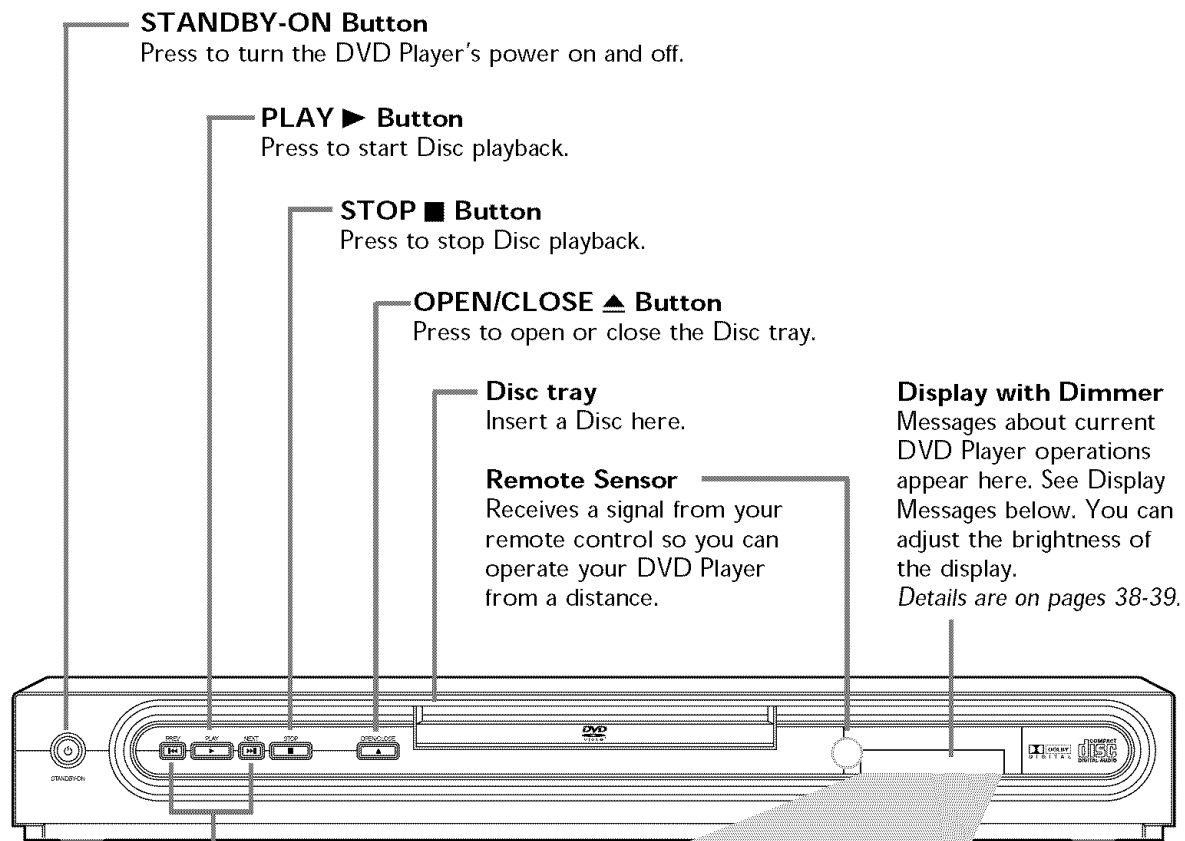

PREV ◀◀ and NEXT ▶▶ Buttons
Press to go to previous or subsequent Tracks or Chapters. Press and hold for about three seconds for a fast forward or reverse search.

REPEAT: A-B
Appears during Repeat Playback, along with A-B, TITLE, CHP, or TRK. Details are on pages 26.

►: Appears during Disc playback.

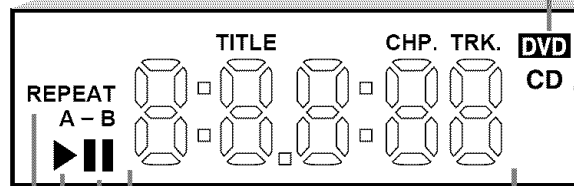

DVD: Lights when a DVD is in the tray and ready for playback.

CD: Lights when an Audio CD is in the tray and ready for playback.

||: Appears when play is paused.

Displays the elapsed playing time of the current Title or Track. Briefly displays Title, Chapter, or Track numbers.

Display Messages

P-ON	Power is turning on.	CLOSE	Tray is closing.
- - - -	Appears after the disc tray closes if the tray is empty, if there is an error reading the disc, or if an unacceptable disc is installed.	Load	Disc is loading.
OPEN	Tray is opening or is open.	P-OFF	Power is turning off.

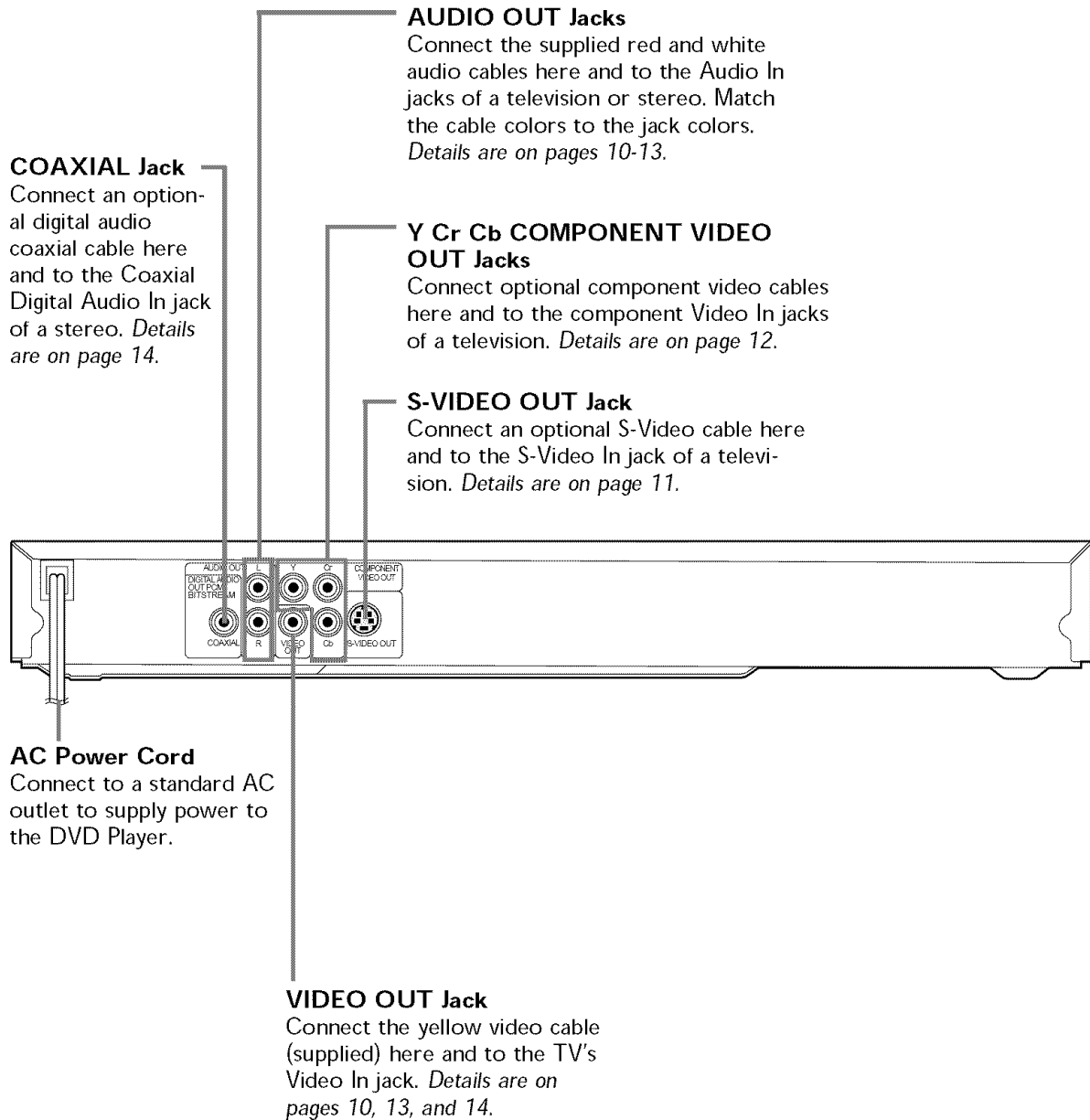

Helpful Hint

- You only need one audio connection and one video connection, so you will not have a cable connected to every jack. For example, if you are using the S-VIDEO OUT jack, you will not use the yellow VIDEO OUT jack or the Y Cr Cb COMPONENT VIDEO OUT jacks.

20 Menus

DVD Disc Menus

Some DVDs contain menus that describe the contents of the Disc or allow you to customize Disc playback. For example, the menu may offer choices for subtitle languages, director's commentary, or soundtrack playback.

To use the DVD menu and select playback features, follow these steps.

- 1 Press MENU.** The DVD's main menu will appear.
- 2 Press ▲▼◀▶ to select an item, then press OK.** Continue this process to set up all the features you want.

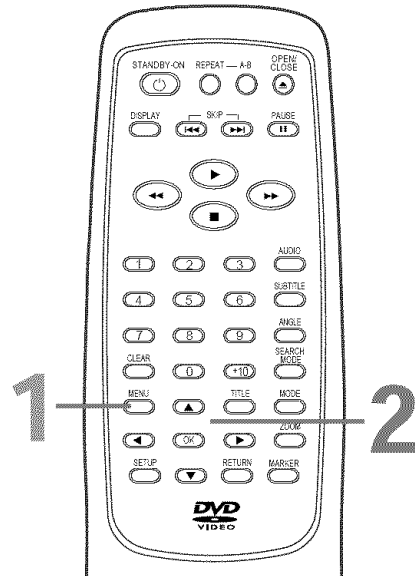

Title Menu

Some DVDs have a Title Menu, which lists the Titles available on the Disc. Use the Title Menu to start playback at a specific Title.

- 1 While playback is stopped, press TITLE.** The Title Menu will appear. If a Title menu is not available, the "X" may appear on the TV screen. If the DVD only has a main menu as described above, it may appear when you press TITLE.
- 2 Press ▲▼◀▶ to select a Title, then press OK.** Play will begin at the Title you selected.

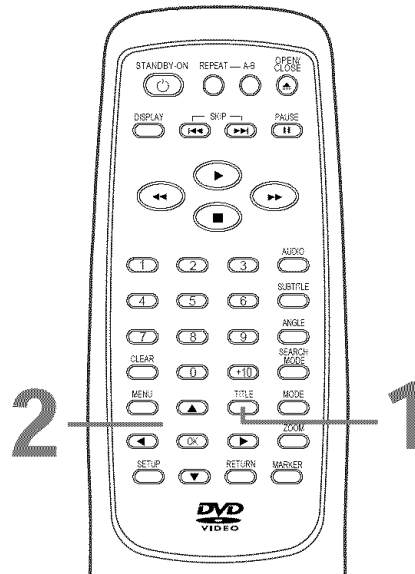





Helpful Hints

- Menus may vary among Discs. Refer to the literature accompanying the Disc for details.
- Not all DVDs have Title menus.
- Some DVDs may refer to Chapters as "scenes." Some DVDs may refer to the Title Menu as the "scene index."
- The TITLE button may not be active with all DVDs.

Paused and Step-by-Step Playback, Resume On 21

Paused and Step-by-Step Playback

- 1** During playback, press **PAUSE** . Play will pause and the sound will be mute.
- 2** When playing a DVD, press **PAUSE**  repeatedly to see the picture advance one frame (or step) at a time. The sound will remain mute. Pressing **PAUSE**  repeatedly during Audio CD, MP3, or JPEG playback will have no effect.
- 3** Press **Play**  to resume playback.

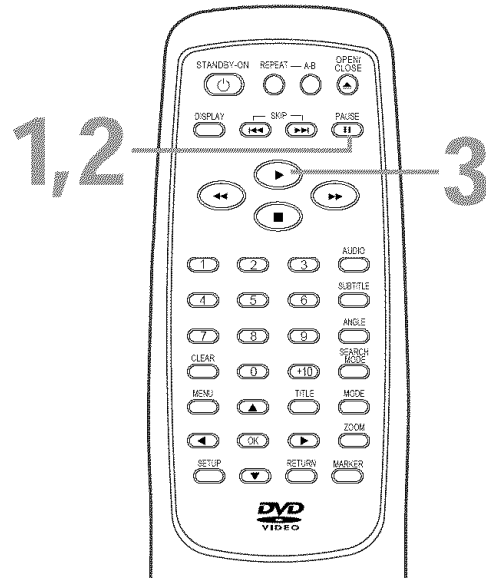



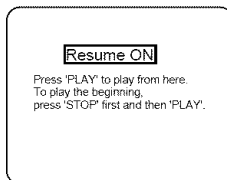

Resume On

You may choose to resume play from the point at which play stopped last.

- 1** Press **Stop**  during DVD or Audio CD playback. In a few seconds, the following Resume message will appear on the TV screen. (The file list will appear during MP3 or JPEG playback.)



- 2** Press **Play** . In a few seconds, play will resume from the point at which it stopped last. You can resume play at the same point even if you turn off the DVD Player, then turn it on again later. However, opening the disc tray will cancel the Resume feature. Play will start at the beginning the next time you insert the Disc.
To cancel Resume and start playing the Disc from the beginning, press **Stop**  a second time while play is stopped. The Stop symbol () will appear briefly on the TV screen. Press **Play**  to start playing the Disc from the beginning.

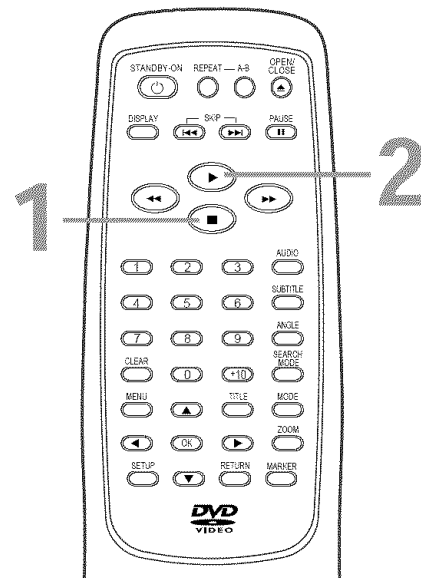

Helpful Hints

- In some cases, you need to press **Play**  while the Resume message appears in order to resume play from the same point.
- Resume On is not available for MP3 files.

22 Fast Forward/Reverse Search

1 During playback, press Fast Forward ►► or Reverse ◀◀ on the remote control.

- During DVD playback, pressing FF ►► or REW ◀◀ will forward or reverse the picture at two, eight, 50, or 100 times the normal playback speed. An ◀◀ 2, ◀◀ 8, ◀◀ 50, or ◀◀ 100 will appear briefly on the TV screen to indicate reverse searching. Or, ►► 2, ►► 8, ►► 50, or ►► 100 will appear briefly on the TV screen to indicate fast forward searching. Sound will be muted during searching.
- During Audio CD playback, you may search only at 16 times the normal playback speed. An ◀◀ 16 or ►► 16 will appear briefly on the TV screen. Sound will be intermittent during searching on an Audio CD.
- During MP3 playback, you can search at only eight times the normal speed. An ◀◀ 8 or ►► 8 will appear briefly on the TV.

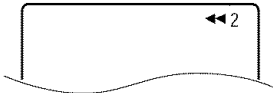

Example: Playing a DVD in reverse at twice the normal playing speed.

2 Press Play ► to return to normal playback.

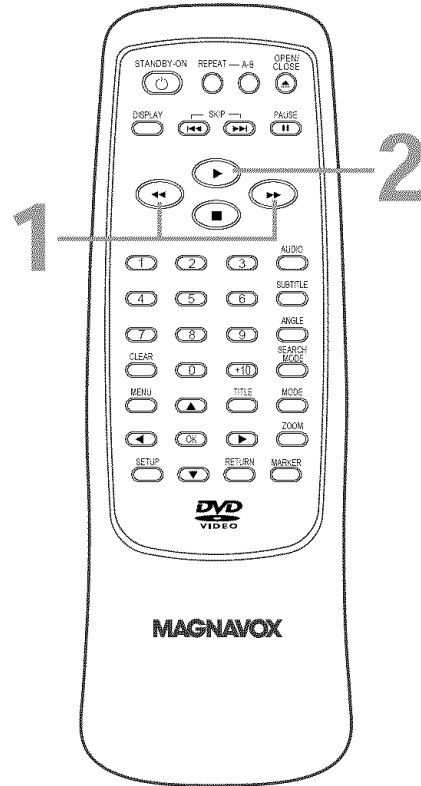

Slow Motion

- 1 Press PAUSE **II** during DVD playback.
- 2 Press Fast Forward **▶▶** or Reverse **◀◀**. Slow motion playback will begin. Press Fast Forward **▶▶** or Reverse **◀◀** repeatedly during slow motion playback to play the DVD forward or backward at 1/16, 1/8, or 1/2 the normal speed.

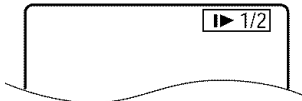

Example: Playing a DVD forward at half the normal speed.

- 3 Press Play **▶** to return to normal playback.

Zoom

You can make the DVD picture or JPEG image two or four times larger than normal.

- 1 Press ZOOM during playback or when play is paused. The picture will appear twice as large. Press ZOOM again to make the picture four times as large as normal. Either x2 or x4 will appear beside the zoom icon in the upper left corner of the TV screen.
- 2 While the picture is enlarged, press **▲**, **▼**, **◀**, or **▶** to move the zoomed image up, down, left, or right. The gray box with an inner blue box that shows during Zoomed playback is the position guide. To remove it or show it, press OK. The position of the blue box inside the gray box indicates the position of the zoomed image within the overall picture.

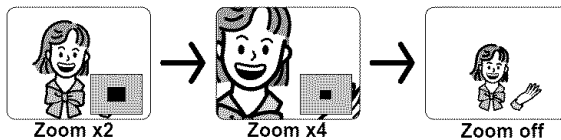

- 3 To return the picture to normal, press ZOOM repeatedly.

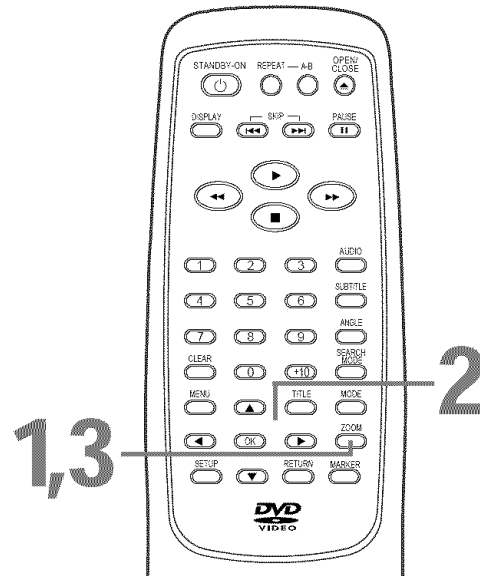
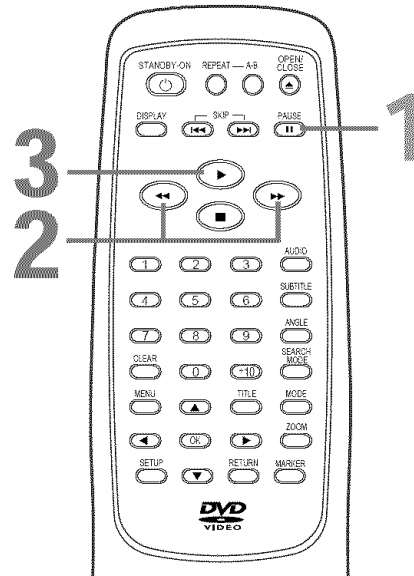

Helpful Hints

- The sound will be mute when play is paused and during slow motion playback.
- Zooming does not work while the DVD Disc menu is active.
- The x4 zooming is not active with some Discs. Only x2 zooming is available for JPEGs.

24 Track Playback

There are three ways to begin playback on an Audio CD at a specific Track. Use the Number buttons, the SEARCH MODE button, or SKIP **⏮** and **⏭**.

A

Using the Number Buttons

Press the Number buttons to enter a Track number.

Playback will start at the selected Track.

For single-digit Tracks (1-9), press a single Number button.

For Tracks 10 and above, press the +10 button so the Search display (TR - -) appears on the TV. Press the Number button of the first digit, then press the Number button of the second digit.

For example, to play Track 26, press +10, then Number 2, then Number 6.

If you enter a Track number that is not available on the Disc, playback will not begin (or the current Track will continue to play).

B

Using SEARCH MODE

Press SEARCH MODE so the Track Search display (TR) appears. Within 30 seconds, press the Number buttons to select the Track number. Playback will begin at the selected Track. For a single-digit Track (1-9), enter a zero first. For example, to play Track 5, press 0, 5. You do not have to use the +10 button in Search Mode.

C

Using SKIP **⏮** and **⏭**

During playback, press SKIP **⏭ to skip the current Track and move to the next Track.** The Track number will appear briefly on the Player's display panel.

During playback, press SKIP **⏮ to return to the beginning of the current Track or press repeatedly to go to previous Tracks.** The Track number will appear briefly on the Player's display panel.

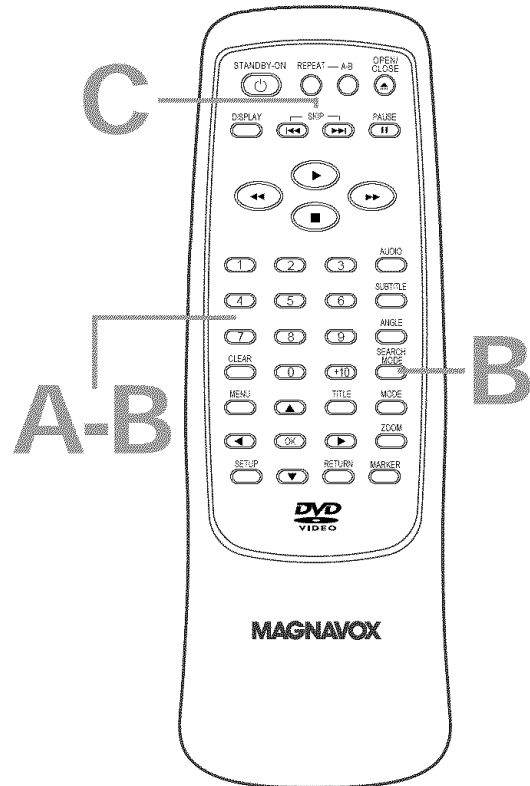

Helpful Hints

- SKIP **⏮** and **⏭** are not active when play is stopped.
- You cannot use SKIP **⏮** or **⏭** to go from the last Track on the disc to the first Track.

Title/Chapter Playback, Time Playback 25

Title/Chapter Playback

- 1** During DVD playback, press **SEARCH MODE** until CH (for Chapter) or TT (for Title) appears on the TV screen. The number of available Titles or Chapters will appear at the right (/4, for example).
- 2** Enter the Title or Chapter number using the **Number buttons**. The selected Title or Chapter will start to play.

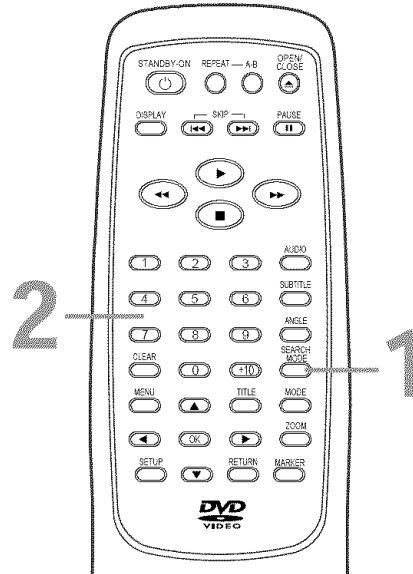
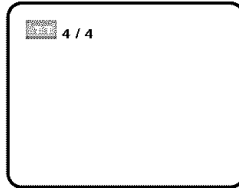
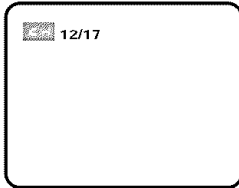

Time Playback

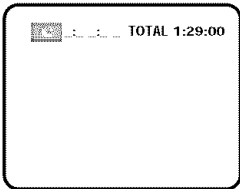
- 1** During DVD or Audio CD playback, press **SEARCH MODE** until the Time Search display appears.
- 
- The TV screen shows a "Time Search" display with a progress bar and the text "TOTAL 1:29:00".
- 2** Within 30 seconds, use the **Number buttons** to enter the elapsed playing time (of the current Track or Title) at which you want playback to begin. Enter the time in hours, minutes, and seconds. Within a few seconds, playback will start at the specified time.
 - Example: 1 hour, 23 minutes, and 30 seconds
1 → 2 → 3 → 3 → 0
 - Make sure the time you enter is within the total time of the current Title or Track. If it is not, the time space will clear and playback will continue at its current point. The total time available in the current Track or Title will appear in the Time Search display.
 - If you make a mistake entering the time, press **CLEAR** to clear the time area. Enter the correct information.

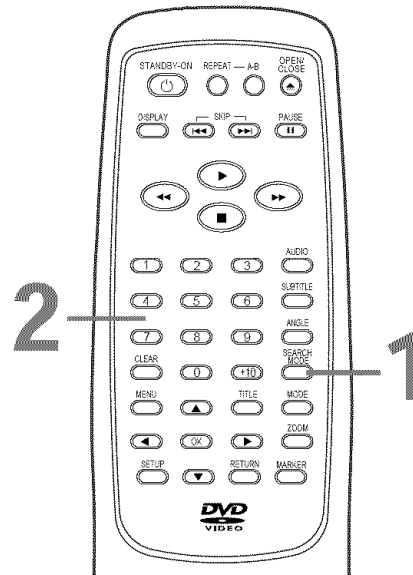

Helpful Hint

- Title/Chapter playback is not available with some DVDs.

26 Repeat Playback, A-B Repeat Playback

Repeat Playback

- 1** During DVD or Audio CD playback, press **REPEAT** until the repeat mode you want appears on the TV.
On a DVD, select CHAPTER, TITLE, or OFF. On an Audio CD, select TRACK, ALL (all Tracks on the Disc), or OFF. With MP3 files you can select TRACK, GROUP, or ALL (all Tracks in the current Folder).
Selecting a new Track, Chapter, or Title will cancel repeat playback.



Example: Repeat a DVD Chapter

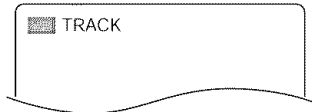

Example: Repeat an Audio CD Track

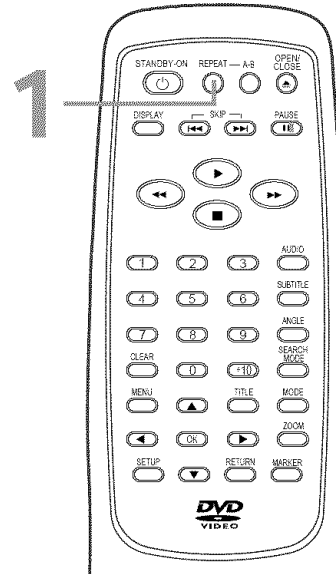

A-B Repeat Playback

You can play a section of an Audio CD or DVD repeatedly. Follow these steps to set up the section that you want to play over and over.

- 1** Press **Play** ► to play the Disc to the point at which you want repeated playback to begin.
- 2** Press **A-B REPEAT** to set the starting point (A). If you make a mistake, press **CLEAR**. This will erase point A and let you start over. **OFF** will appear briefly on the TV screen.

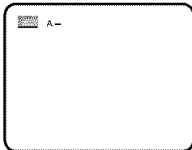

- 3** Play the Disc to the point at which you want repeated playback to end, then press **A-B REPEAT** again. Within a few seconds, the section will begin to play. The segment will play over and over until you cancel the A-B Repeat feature.

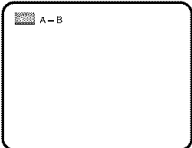

- 4** To cancel A-B Repeat Playback, press **A-B REPEAT** so **OFF** appears on the TV screen. Regular Disc playback will resume.

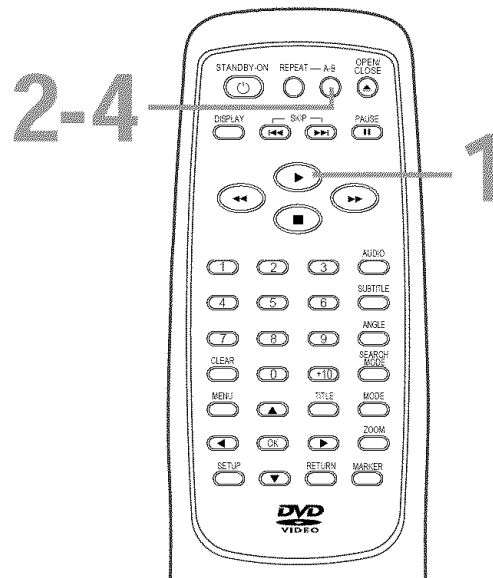

Helpful Hints

- Repeat playback is not available with some Discs.
- The entire A-B Repeat section must be within a single Title or Track. If you do not enter Point B before the end of the Track or Title is reached, the end of the Track or Title will become Point B automatically.
- Point B must be later on the Disc than Point A.

You may determine the order in which Audio CD Tracks will play. You also can program MP3 or JPEG files to play in a special order. To set a Program, follow these steps.

- 1 While playback is stopped, press MODE.**
The PROGRAM screen will appear.

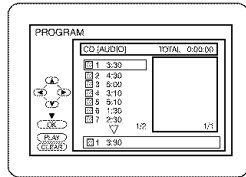

Audio CD example

- 2 Press ▲ or ▼ to select a track you want to play, then press OK.** Press CLEAR to erase the last Track in the Program if you make an error. Additional Tracks may be on other screens. Press ▼ or ▲ to see all the Tracks.
Repeat this step until you have selected all the Tracks you wish to play in the Program.
- 3 Press Play ►.** The Tracks will play once in the order you set. Turning off the Player or opening the disc tray will erase the Program.

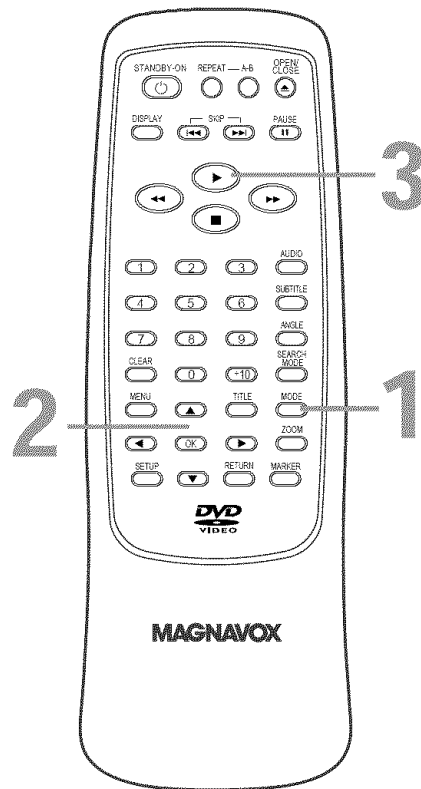

Helpful Hints

- You cannot use the Number buttons or SEARCH MODE to select another Track while playing a Program. Use SKIP ►► or ◀◀ to select other Tracks within the Program.
- You cannot combine random playback with programmed playback.
- You may play a Program or a Track within a Program repeatedly. During programmed playback, press REPEAT so ALL (all Tracks in the Program) or TRACK appears. The entire Program or the current Track will play over and over.
- During MP3 play, sometimes you can choose to play a GROUP (Folder) repeatedly.
- You cannot alter a Program during playback.
- You can start Program play only while in the PROGRAM screen.
- A Program can have a maximum of 99 Tracks.

28 Random Playback

You may play the Tracks of an Audio CD in Random order instead of the order in which they are recorded (1,2,3...). You can also use this feature for JPEG and MP3 files.

- 1 While playback is stopped, **press MODE twice so the RANDOM screen appears.**

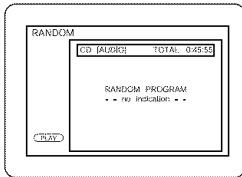

Example: Audio CD

- 2 While the RANDOM screen appears, **press Play ►**. The Tracks will play in random order. After all the Tracks have played once, play will stop.

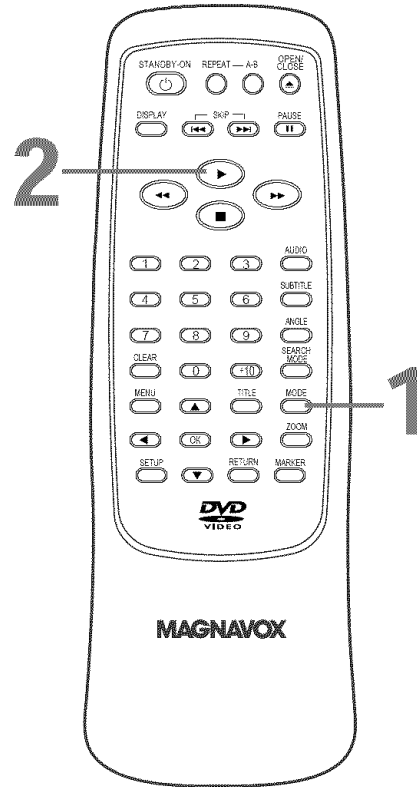

The DVD Player will play MP3 or JPEG files that you record and finalize on a CD-RW (Compact Disc-Rewritable) or CD-R (Compact Disc-Recordable).

These Discs may contain pictures in a JPEG format or audio Tracks in an MP3 format. For example, you may have photographic film developed by a retailer that places the pictures on a CD-R for you. These pictures may be in JPEG format. Or, you may copy or download MP3 music files from certain legal Internet sites, then copy those files onto a CD-R or CD-RW.

You cannot make or record such Discs using this Player. See your computer manual for details on recording.

Keep these characteristics in mind when making Discs you intend to play on the DVD Player.

- Record MP3 Tracks at a sampling frequency of 44.1 kHz or 48 kHz. Use a bit rate between 112 kbps and 320 kbps.
- When recording JPEG Files, the size of the picture should be between 32 x 32 and 6300 x 5100 dots.

1 When you put a CD-RW or CD-R with MP3 or JPEG files in the Player, the File List will appear on the TV screen. To see the File List during playback, press SEARCH MODE. The current Track will be highlighted. **Press ▲ or ▼ to select a Folder, MP3 Track, or JPEG File.**

2 If you choose a Track or File, press Play ► or OK.

Starting with the Track or File you selected, the Tracks/Files will play in the order they were recorded, i.e. 1, 2, 3,

If you select a Folder and press OK, the Tracks or Files within that Folder will appear. Press ▲ or ▼ to select the Track or File you want, then press Play ► or OK.

- Choose FIRST PLAY to start play from the first individual File or Track listed.
- Press TITLE to return to the first item on the first MP3 or JPEG screen. You also can press ◀ to return to previous screens.
- During JPEG playback, press MODE to choose a transition mode. For example, you can choose Cut in/Cut off or Fade in/Fade out. Press MODE again to remove the transition modes.

3 To stop playback, press Stop ■.

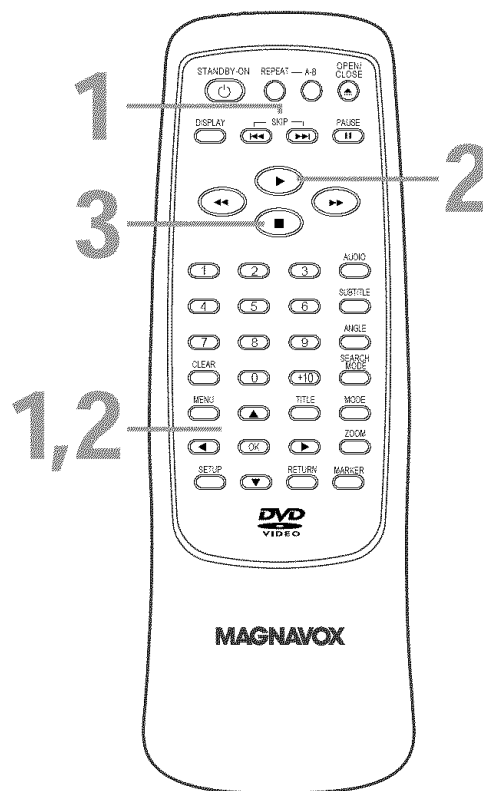

Helpful Hints

- JPEG images and MP3 Tracks are known as Files. Groups of Files are called Folders.
- JPEG Files have the ☺ icon.
- A maximum of 255 Folders can be recognized. A maximum of 256 Files can be recognized.
- MP3 Files have the 🎵 icon.
- During playback, press the Number buttons to select another Track. Or, press SKIP ►►► or ◀◀◀ to change Tracks.
- If a Track is not available, "X" will appear on the TV screen. Play may resume at an incorrect Track or may continue with its current Track.
- Specific Time playback is not possible with MP3 Tracks.



30 MP3/JPEG Displays

You can review MP3 and JPEG Track (File) information during playback.

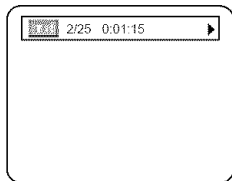
- 1 Press **DISPLAY** until the current Track number, total Tracks available, and elapsed playing time of the current Track appear.



The following may appear to indicate Repeat play.

-  T: The current Track will play repeatedly.
-  G: Tracks in the current Folder (Group) will play repeatedly.
-  A: All Tracks will play repeatedly.

- 2 Press **DISPLAY** again to remove the display.

1,2

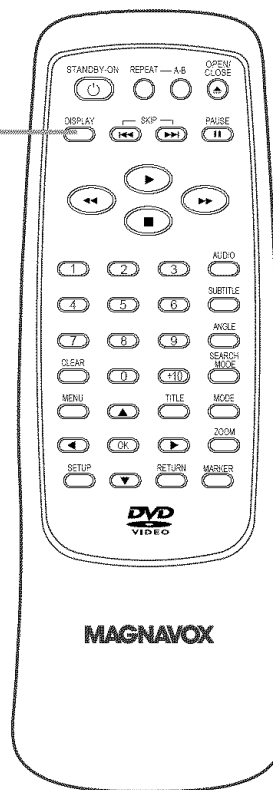

Helpful Hint

- During MP3 playback, the  icon and the current Track name will appear when you first press DISPLAY.

Audio Language, Stereo Sound Mode 31

Audio Language

You can select a language for DVDs during playback if multiple languages are available.

- 1** During DVD playback, press **AUDIO** repeatedly to choose one of the available languages. The new audio will be heard. The display will disappear after about five seconds. The Audio display may show if the DVD has Dolby Digital or multi-channel (5.1 CH) sound or its sampling rate (48k, for example). The number of available languages appears after the "/" at the right of the display (/3, for example).

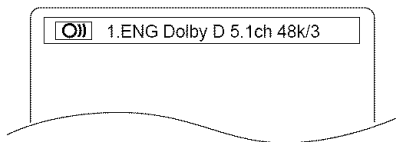

Example: English audio

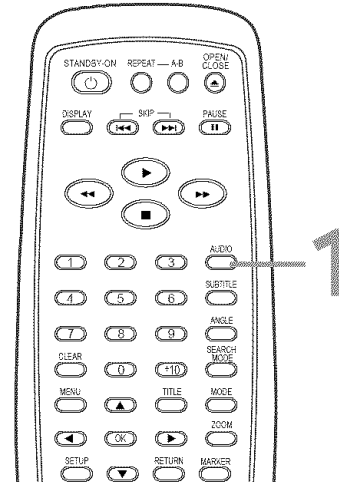

Stereo Sound Mode

Adjust Stereo Sound to determine whether you will hear the left channel, the right channel, or both channels (stereo) during Audio CD playback.

- 1** Press **AUDIO** during Audio CD playback to choose **STEREO**, **L-CH**, or **R-CH**.

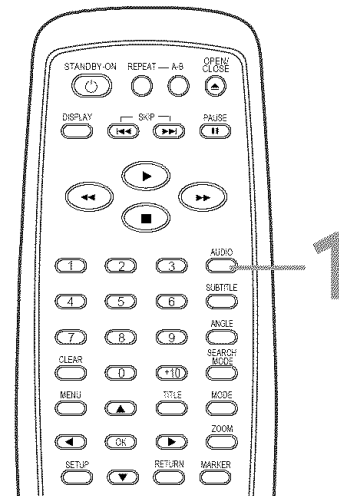
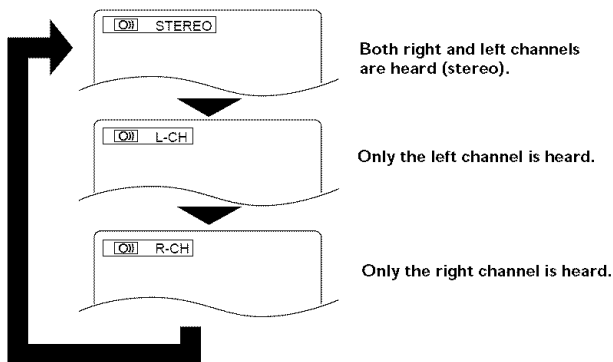

Helpful Hints

- If a language is not available after pressing **AUDIO** several times, the DVD does not have that language.
- Some DVDs only let you change the language in the Disc menu.
- Audio languages may be abbreviated (such as ENG for English). Or, three dashes (- - -) may appear instead of an abbreviation.
- You cannot adjust the Stereo Sound Mode when Virtual Surround is active. Details are on page 42.

32 Subtitle Language, Camera Angles

Subtitle Language

The DVD Player allows you to select a language for subtitles during playback. You may select only the subtitles that are available on the Disc.

- 1 During playback, press SUBTITLE to select a subtitle language.** The number of available languages appears at the right of the subtitle display. In the example below, six languages are available (/6). After a few seconds, the subtitles will appear. Or, press SUBTITLE to turn off subtitles.

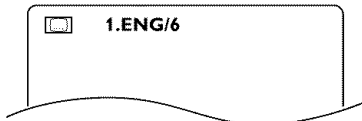

Example: English as first of six available subtitles

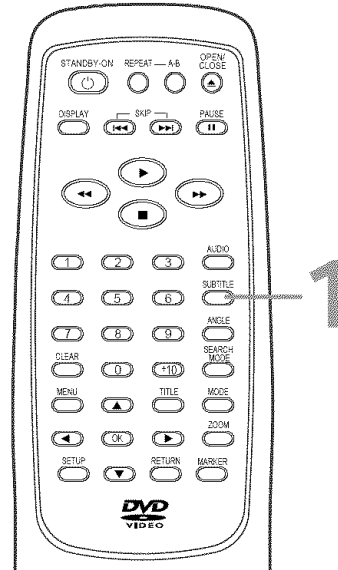

Camera Angles

Some DVDs contain scenes recorded from different angles. The camera angle will not change if the DVD does not contain sequences recorded from different camera angles.

- 1 During playback, press ANGLE to select a different angle.** The number of available angles appears at the right of the Angle display. In this example, eight angles are available (/8).

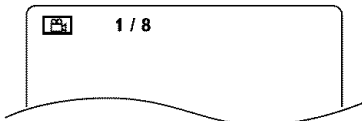

Example: Angle 1 of eight available angles

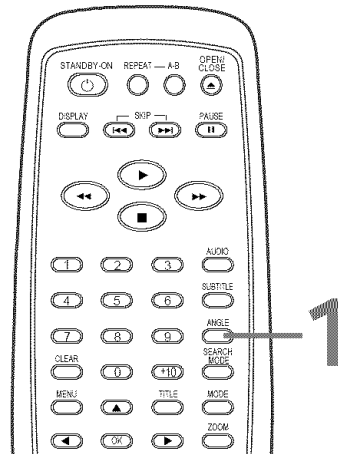

Helpful Hints

- With some DVDs, you must select a subtitle language in the Disc menu.
- If the desired language does not appear after pressing SUBTITLE several times, the Disc does not have subtitles in that language.
- Opening the disc tray will cancel your subtitle setting.
- If the current portion of the Disc has multiple camera angles,  will appear on the TV screen. ANGLE ICON must be ON. Details are on pages 38-39.

DVD Display

1 Press DISPLAY repeatedly to see the following displays during DVD playback.

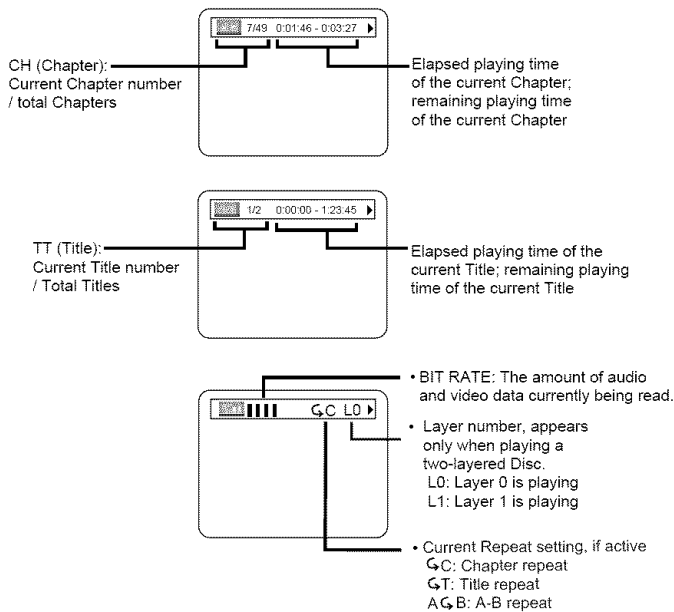

1,2

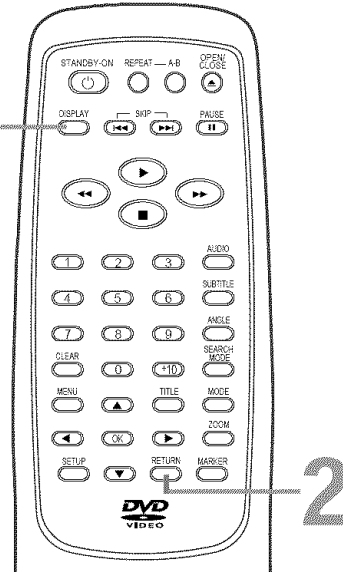

2 Press DISPLAY repeatedly or press RETURN to remove the display.

Audio CD Display

1 Press DISPLAY repeatedly to see the following displays during Audio CD playback.

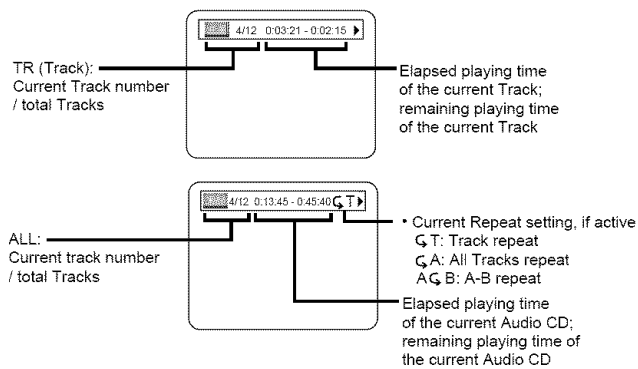

1,2

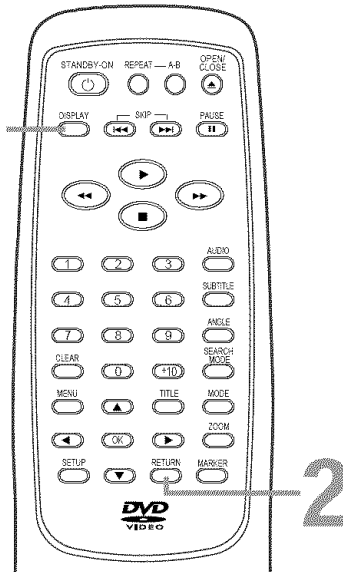

2 Press DISPLAY repeatedly or press RETURN to remove the display.

34 Parental Password

The Parental feature prevents viewing of DVDs that exceed your rating limits. This feature will not limit viewing if the DVD is not rated or coded. Check your DVDs and settings before letting children access the Player. Follow these steps to change your password.

1 Press SETUP while play is stopped.

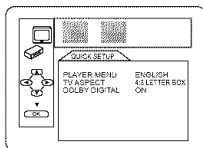

2 Press ► to select CUSTOM at the top of the menu, then press OK.

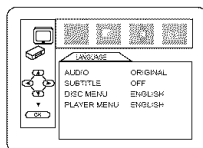

3 Press ► to select  (the lock), then press OK. The first time you set a password, this menu will appear.

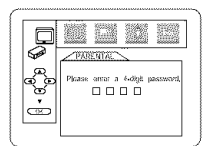

Press the Number buttons to enter a four-digit password. The password will appear on the screen. Write it down so you don't forget it.
Press OK. You are finished! Go to step 6.

If you have set a password before, this menu will appear.

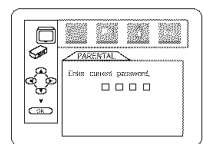

Press the Number buttons to enter your current four-digit password. Asterisks (*) will appear instead of your password. This protects its identity.

4 Press ▼ to select CHANGE, then press OK.

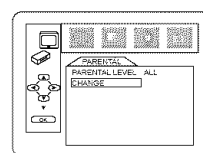

5 Press the Number buttons to enter a four-digit password. The password numbers will appear on the screen. Write down the password so you will not forget it. **Press OK.** The previous menu will reappear.

6 Press SETUP to remove the menu.

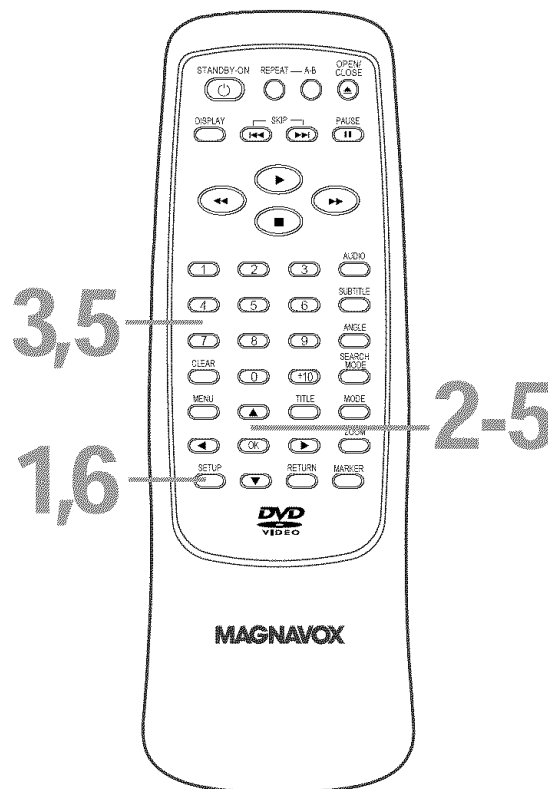

Helpful Hints

- The default password is 4737. If you forget your password, press Number buttons 4, 7, 3, 7 at step 3. You will be prompted to enter a new four-digit password. Use the Number buttons to enter a new four-digit password, then press OK. PARENTAL LEVEL will reset to ALL. Press SETUP to remove the menu. See page 35 to reset PARENTAL LEVEL as you desire.
- A power failure will not erase your password.

Follow these steps to set the rating level for your DVDs.
DVDs whose ratings exceed the level you set will not play.

1 Press **SETUP** while play is stopped.

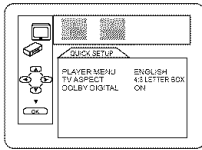

2 Press **▶** to select **CUSTOM** at the top of the menu, then press **OK**.

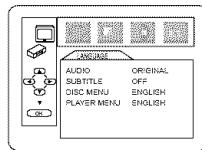

3 Press **▶** to select **Ⓐ** (the lock), then press **OK**.

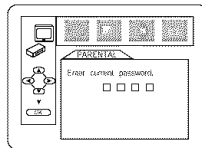

4 Press the **Number** buttons to enter your four-digit password.

5 Press **▲** or **▼** to select **PARENTAL LEVEL**, then press **OK**.

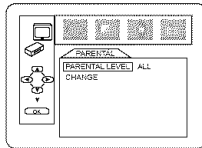

6 Press **▲** or **▼** to select a level, then press **OK**.
The rating levels continue on two menu screens. Press **▲** or **▼** repeatedly to move to the next or previous screen to find the rating level you want. After making your selection, the previous menu will appear. The level you selected will appear beside **PARENTAL LEVEL**.

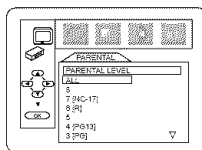

7 Press **SETUP** to remove the menu.

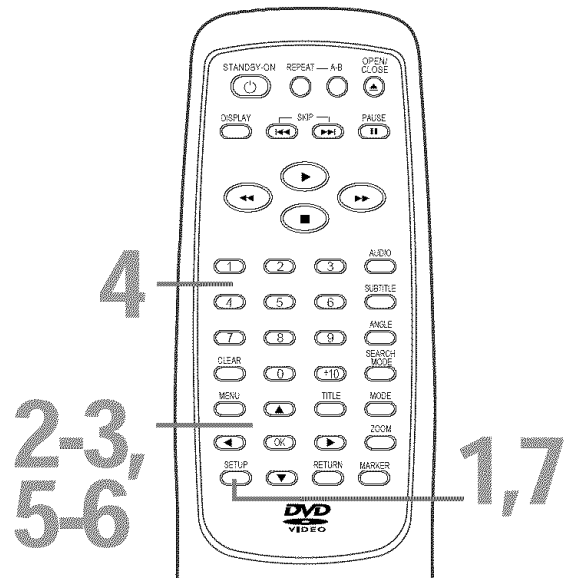

RATING EXPLANATIONS

- ALL - The Parental feature is inactive; all discs can play.
- 8 - Adult material
- 7 - NC-17 - Not appropriate for children under 17
- 6 - R - Restricted; parental approval required for viewers under 18.
- 4 - PG13 - Unsuitable for children under 13
- 3 - PG - Parental Guidance suggested.
- 1 - G - General Audience; recommended for all ages.

Helpful Hints

- When you try to play a DVD whose rating exceeds the level you set, an on-screen message will indicate the DVD cannot play. Remove the DVD, then set **PARENTAL LEVEL** to **ALL**. Reload the DVD and begin playback. Some DVDs may let you enter your four-digit password to begin playback. Follow the on-screen messages as prompted.
- You cannot use the default password (4737) to play a DVD.

36 Marker

Use Markers to remember your favorite places on an Audio CD or DVD. To set the Markers, follow these steps.

- 1 Play the Disc to within 30 seconds prior to the point at which you want to set the Marker. **During playback, press MARKER until the Markers appear at the top of the TV screen.**

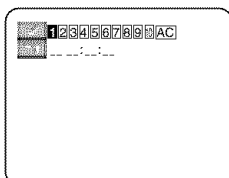

DVD example

- 2 Within 30 seconds, press ◀ or ▶ to select a Marker (1-10). Make sure ___ : ___ : ___ appears beneath the number.

- 3 Let the Disc play to the point at which you want to set the Marker (up to 30 seconds away). **When the Disc reaches the point you want to remember, press OK.** The Title number and elapsed playing time (DVD) or Track number and its elapsed playing time (Audio CD) will appear. A checkmark will replace the Marker number. The Marker display will disappear in about 30 seconds, or press MARKER again to remove the Marker display.

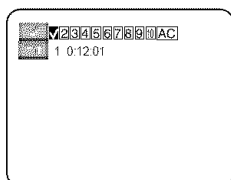

DVD example

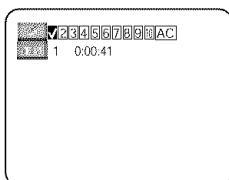

Audio CD example

- 4 To return to a Marker during playback, press MARKER until you see the Markers. Press ◀ or ▶ to choose the Marker you want, then press OK. Disc play will continue from the marked point.

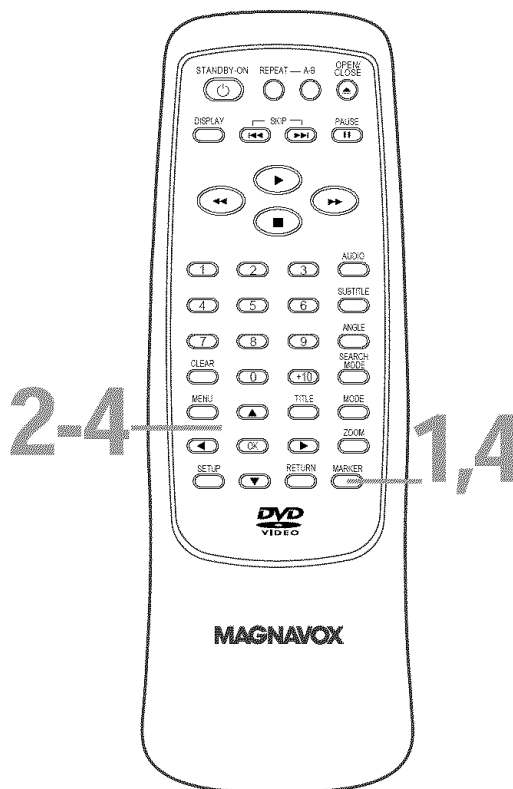

Helpful Hints

- Opening the disc tray or turning off the Player will erase all the Markers.
- To erase a single Marker, press MARKER until you see the Markers. Press ◀ or ▶ to select a Marker. Press CLEAR. Press RETURN or MARKER to remove the display.
- To erase all the Markers, press MARKER until you see the Markers. Press ▶ to select AC (All Clear), then press OK. Press MARKER or RETURN to remove the display.

Change Audio settings based on other equipment you connected to the DVD Player or according to your Disc sound features.

- 1 While playback is stopped, press **SETUP**. The QUICK SETUP screen will appear.

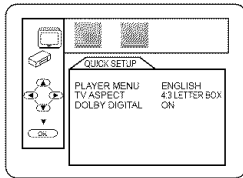

- 2 Press **▶** to select **CUSTOM** at the top of the menu, then press **OK**.

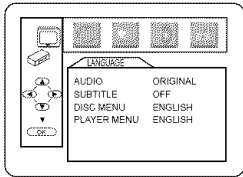

- 3 Press **▶** to select **AUDIO** (), then press **OK**.

- 4 Press **▲** or **▼** to select **DRC**, **DOLBY DIGITAL**, or **DOWN SAMPLING**, then follow step 5 accordingly.

- 5
 - If you selected **DRC**, press **OK** repeatedly to turn Dynamic Range Control (DRC) **ON** or **OFF**. Choosing **ON** compresses the range of volume by suppressing loud sounds and raising low sounds.
 - If you selected **DOLBY DIGITAL**, press **OK** repeatedly to select **ON** or **OFF**. Select **ON** if you used the **COAXIAL DIGITAL AUDIO OUT** jack to connect the DVD Player to a stereo that is Dolby Digital compatible. *Details are on page 14.* Otherwise, choose **OFF**.
 - If you selected **DOWN SAMPLING**, press **OK** repeatedly to choose **ON** or **OFF**. Choose **ON** to set downsampling to 48 kHz. Choose **OFF** to set downsampling to 96 kHz.

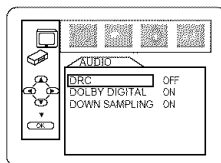

DRC

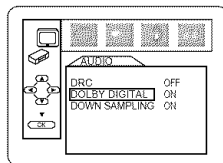

Dolby Digital

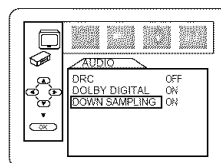

Down Sampling

- 6 Press **SETUP** to remove the menu.

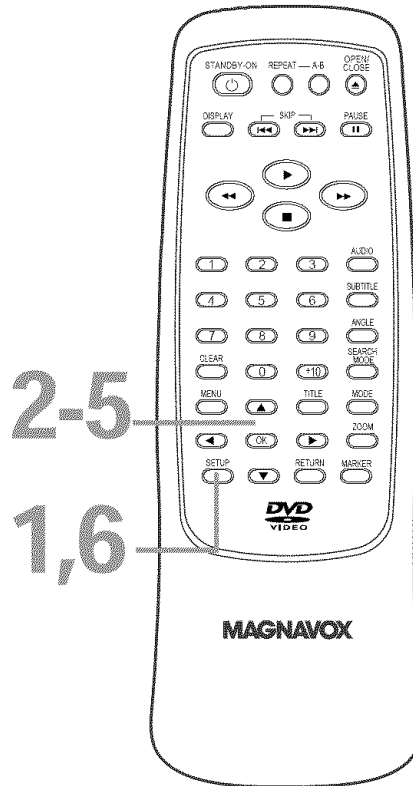

Helpful Hints

- Dolby Digital sound must be available on the DVD.
- You can adjust **DOLBY DIGITAL** in the **QUICK SETUP** menu that appears when you first press **SETUP**. With **QUICK** selected, press **OK**. Press **▼** to select **DOLBY DIGITAL**. Press **OK** to choose **ON** or **OFF**. Press **SETUP** to remove the menu.
- When you play a Disc that has copyright protection, downsampling will be at 48 kHz, even if you set **DOWN SAMPLING** to **OFF**.

38 Display

You can adjust TV Aspect, Angle Icon, Panel Display (brightness), and Automatic Power Off in the Display menu.

- 1 When playback is stopped, press **SETUP**. The QUICK SETUP screen will appear.

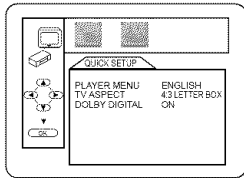

- 2 Press **▶** to select **CUSTOM** at the top of the menu, then press **OK**.

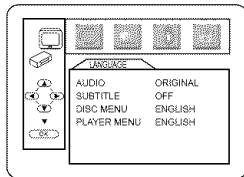

- 3 Press **▶** to select **■** (DISPLAY), then press **OK**.

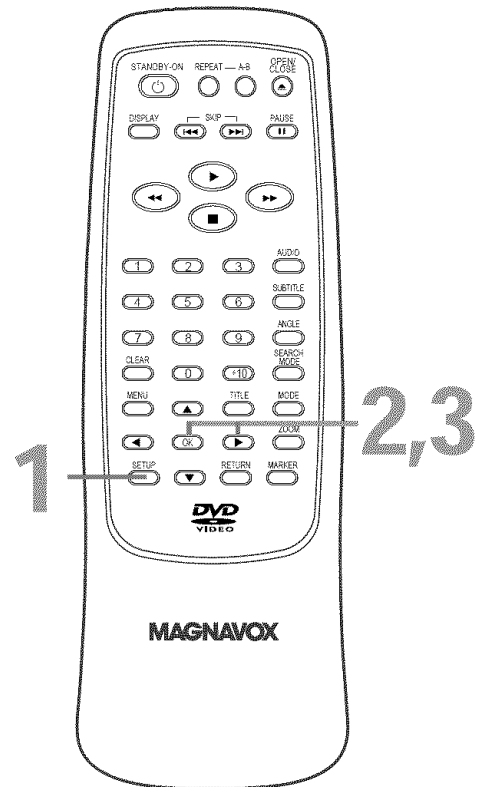
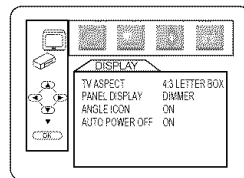

Helpful Hints

- Selecting a different TV ASPECT setting is only effective if it is available on the DVD. Check the DVD Disc menu or case for details.
- You also can adjust TV ASPECT in the QUICK SETUP menu that appears when you first press the SETUP button. With QUICK selected, press OK. Press ▼ to select TV ASPECT, then press OK. Press ▲ or ▼ to choose a setting, then press OK. Press SETUP to remove the menu.

4 Press **▲** or **▼** to select an item, then press **OK**.
 ● If you selected **TV ASPECT**, press **▲** or **▼** to select a setting, then press **OK**.

Choose **4:3 LETTER BOX** if you want to see the entire, widened picture with black bars at the top and bottom of the screen. This looks like the picture you see when watching movies in a theater. This setting is possible only if the DVD was recorded in the letter-box or widescreen format.

Choose **4:3 PAN & SCAN** for a full height picture, with both sides trimmed. Some companies refer to this as reformatting the picture to fit your TV screen and may call it the regular or normal format.

Choose **16:9 WIDE** if you connected a widescreen TV to the DVD Player.

● If you selected **PANEL DISPLAY**, press **▲** or **▼** to choose **BRIGHT**, **DIMMER**, or **AUTO**, then press **OK**. This adjusts the brightness of the display panel. The default setting is **BRIGHT**.

Choose **BRIGHT** to keep the display panel at 100% of its available brightness. Choose **DIMMER** to reduce the display's brightness. Choose **AUTO** to dim the display panel only during Disc playback. *Display panel details are on page 18.*

● If you selected **ANGLE ICON**, press **OK** repeatedly to turn **ANGLE ICON ON** or **OFF**. The default setting is **ON**. Choose **ON** to see the Angle icon when multiple camera angles are available during DVD playback. *Details are on page 32.* Choose **OFF** to disable the Angle icon.

● If you selected **AUTO POWER OFF**, press **OK** repeatedly to set **AUTO POWER OFF** to **ON** or **OFF**. The default setting is **ON**. Choose **ON** if you want the Player to turn off when there is no activity at the Player or its remote for 35 minutes.

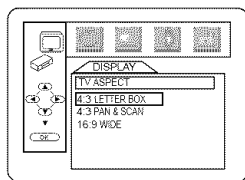
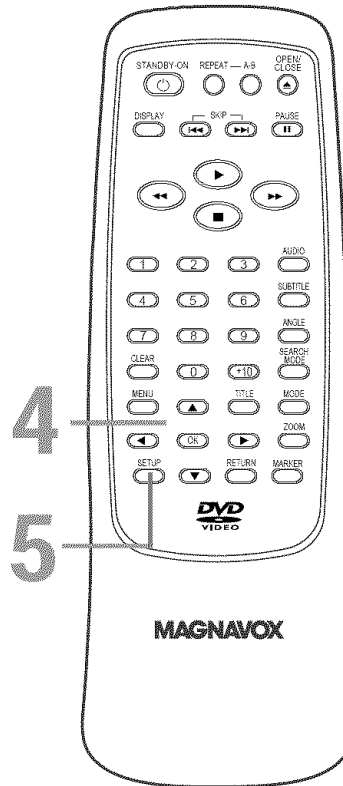

TV ASPECT

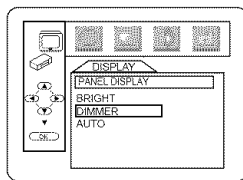

PANEL DISPLAY

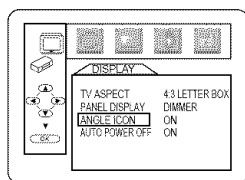

ANGLE ICON

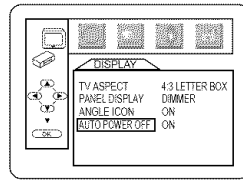

AUTO POWER OFF

5 Press **SETUP** to remove the menus.

40 Language

You can use the LANGUAGE settings to select different languages for the Audio or Subtitles of DVDs, as well as languages for DVD Disc menus and the menus of the DVD Player SETUP menus.

- 1 While playback is stopped, press **SETUP**. The QUICK SETUP screen appears.

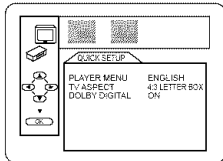

- 2 Press **▶** to select **CUSTOM** at the top of the menu, then press **OK**.

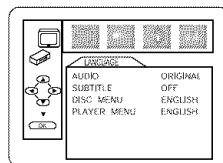

- 3 The Language menu () will be selected. Press **OK**.

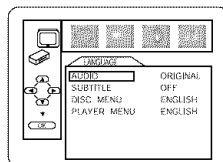

- 4 Press **▲** or **▼** to select **AUDIO**, **SUBTITLE**, **DISC MENU**, or **PLAYER MENU**. Then, press **OK**. The language options for the selected item will appear.

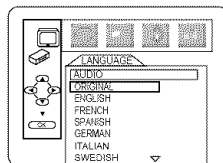

AUDIO: The DVD's audio plays in the selected language.

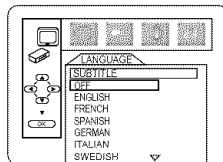

SUBTITLE: Subtitles appear in the chosen language.

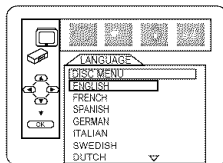

DISC MENU: A DVD's Disc menu appears in the chosen language.

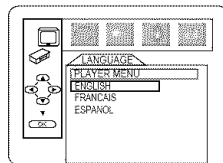

PLAYER MENU: The DVD Player's Setup menu can be in English, French, or Spanish only.

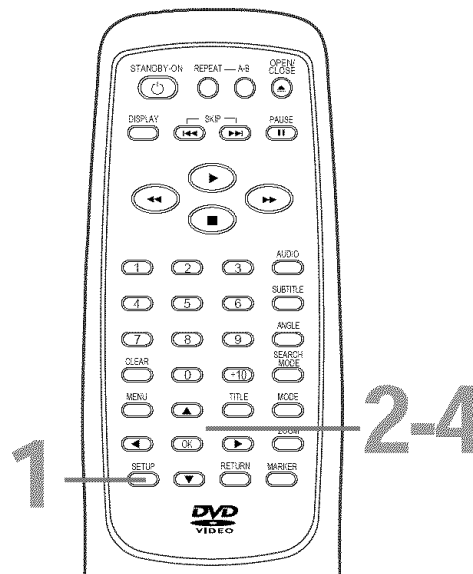

Helpful Hints

- If the DVD's default settings for Audio and Subtitle are the same language, the subtitles may not show unless you turn them on.
- Use the **AUDIO** and **SUBTITLE** buttons to select Audio and Subtitles available on the DVD. Details are on pages 31 and 32.
- If you set **AUDIO** to **ORIGINAL**, the default setting of the DVD Audio will play.
- If you set **PLAYER MENU** to **French** or **Spanish** and need **English**: Follow steps 1-2. At step 3, the **IDIOMA** or **LANGUE** menu will appear. Press **▼** to select **MENU DU LECTEUR** or **MENU REPRODUC.**, then press **OK**. Press **▲** to select **ENGLISH**, then press **OK**. The menus will change to **English**. Press **SETUP** to remove the menus.
- You can change the **PLAYER MENU** language in the **QUICK SETUP** menu that appears when you first press **SETUP**. With **QUICK** selected, press **OK**. **PLAYER MENU** will be selected. Press **OK**. Press **▲** or **▼** to choose a language, then press **OK**. Press **SETUP** to remove the menu.

- 5** Press **▲** or **▼** to select a language, then press **OK**. The language lists may continue on multiple screens. Press **▲** or **▼** to move to the other screens.
- If you select **OTHER** for **AUDIO**, **SUBTITLE**, or **DISC MENU**, press four Number buttons to enter the code for the language you desire. Use the Language Codes below. The language or language code you select will appear in the Language menu beside **AUDIO**, **SUBTITLE**, or **DISC MENU**.

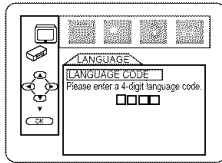

- You can select other languages for **AUDIO**, **SUBTITLE**, and **DISC MENU** only if the language is available on the Disc. If the language you select is not recorded on the DVD, changing these settings will have no effect.

- 6** Press **SETUP** to remove the menu.

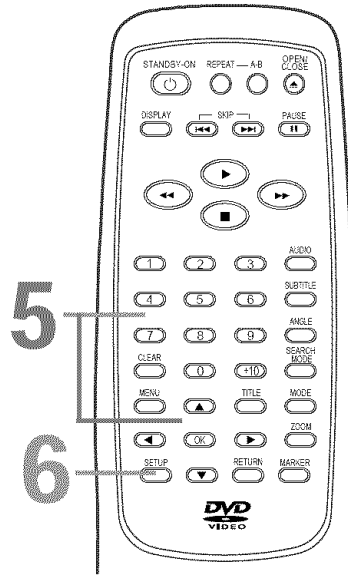

Language Codes

A-B	English	5160	Kannada	5760	Panjabi	6247	T		
Abkhazian	4748	Esperanto	5161	Kashmiri	5765	Pashto	6265	Tagalog	6658
Afar	4747	Estonian	5166	Kazakh	5757	Persian	5247	Tajik	6653
Afrikaans	4752	F-H		Kinyarwanda	6469	Polish	6258	Tamil	6647
Albanian	6563	Faroese	5261	Kirghiz	5771	Portuguese	6266	Tatar	6666
Amharic	4759	Fiji	5256	Kirundi	6460	Pushto	6265	Telugu	6651
Arabic	4764	Finnish	5255	Korean	5761	Quechua	6367	Thai	6654
Armenian	5471	French	5264	Kurdish	5767	Rhaeto-Romance	6459	Tibetan	4861
Assamese	4765	Frisian	5271	L-N		Romanian	6461	Tigrinya	6655
Aymara	4771	Gaelic (Scots)	5350	Laothian	5861	Russian	6467	Tonga	6661
Azerbaijani	4772	Galician	5358	Latin	5847	S		Tsonga	6665
Bangla	4860	Georgian	5747	Latvian	5868	Samoan	6559	Turkish	6664
Bashkir	4847	German	5051	Lettish	5868	Sangho	6553	Turkmen	6657
Basque	5167	Greek	5158	Lingala	5860	Sanskrit	6547	Ukrainian	6757
Bengali	4860	Greenlandic	5758	Lithuanian	5866	Serbian	6564	Urdu	6764
Bhutani	5072	Guarani	5360	Macedonian	5957	Serbo-Croatian	6554	Uzbek	6772
Bihari	4854	Gujarati	5367	Malagasy	5953	Sesotho	6566	Vietnamese	6855
Bislama	4855	Hausa	5447	Malay	5965	Setswana	6660	Volapuk	6861
Breton	4864	Hebrew	5569	Malayalam	5958	Shona	6560	Welsh	4971
Bulgarian	4853	Hindi	5455	Maltese	5966	Sindhi	6550	Wolof	6961
Burmese	5971	Hungarian	5467	Maori	5955	Singhalese	6555	Xhosa	7054
Byelorussian	4851	I-K		Marathi	5964	Siswat	6565	Yiddish	5655
C-E		Icelandic	5565	Moldavian	5961	Slovak	6557	Yoruba	7161
Cambodian	5759	Indonesian	5560	Mongolian	5960	Slovenian	6558	Zulu	7267
Catalan	4947	Interlingua	5547	Nauru	6047	Somali	6561		
Chinese	7254	Interlingue	5551	Nepali	6051	Spanish	5165		
Corsican	4961	Inupiak	5557	Norwegian	6061	Sundanese	6567		
Croatian	5464	Irish	5347	O-R		Swahili	6569		
Czech	4965	Italian	5566	Occitan	6149	Swedish	6568		
Danish	5047	Japanese	5647	Oriya	6164				
Dutch	6058	Javanese	5669	Oromo (Afan)	6159				

42 Black Level, Virtual Surround

Black Level

Adjust Black Level to brighten the DVD picture during playback.

- 1 **During DVD playback, press MODE** so the Black Level icon shows in the top left corner of the TV screen.

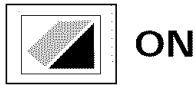

- 2 **Within 10 seconds, press OK repeatedly to choose ON or OFF.** ON brightens the dark parts of the picture. OFF shows the original picture as recorded.

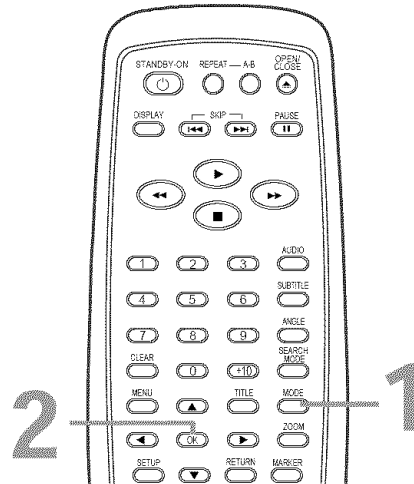

Virtual Surround

You can enjoy improved stereo sound when you play DVDs, Audio CDs, or MP3 files recorded in Dolby Digital or Pulse Code Modulation (PCM). Check the Disc case for details on availability.

- 1 **During Disc playback, press MODE** so the Virtual Surround icon appears in the top left corner of the TV screen.
- 2 **While the Virtual Surround icon appears, press OK to choose 1, 2, or OFF.** The default setting is OFF. The icon will disappear after about 10 seconds.

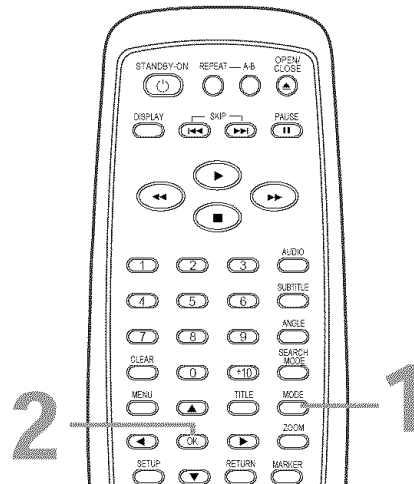
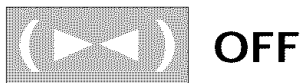

Helpful Hints

- Virtual Surround is available only when the Player is connected to a Stereo or TV using the red and white AUDIO OUT jacks on the Player.
- Virtual Surround is active only if you set Stereo Sound Mode to Stereo. Details are on page 31.

Care and Maintenance

Cleaning the DVD Player

- Wipe the front panel and other exterior surfaces of the Player with a soft, slightly damp cloth.
- Never use a solvent, thinner, benzene, or alcohol to clean the Player. Do not spray insecticide liquid near the Player. Such chemicals may discolor the surface or damage the Player.

Cleaning a Disc

- Use a soft, dry cloth to wipe the Disc.
- Wipe the Disc in a straight line from the center to the edge. Never wipe the Disc in a circular motion.
- Do not use detergent or abrasive cleaning agents.
- Handle the Discs by the edges so fingerprints and dust do not adhere to the surfaces of the Discs.
- Always store the Disc in its protective case when it is not in use.

Checking the Laser

- If the DVD Player does not operate as described in this owner's manual, the laser may be dirty. Consult an Authorized Service Center for inspection and cleaning of the laser.

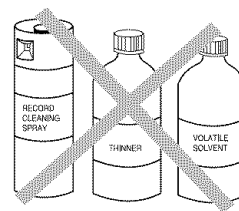

Don't use cleaners.

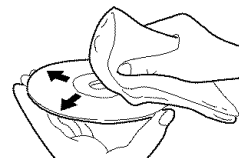

Wipe Discs from the center to the edge.

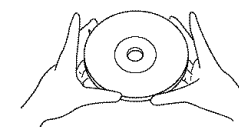

Handle Discs by the edges.

Glossary

AUDIO OUT Jacks: Jacks on the back of the DVD Player that send audio to another system (TV or stereo).

COAXIAL jack: Sends digital audio to a stereo, allowing you to adjust the volume at the stereo. The stereo must have a Coaxial In jack. This connection provides the 5.1 channel surround sound as heard in movie theaters.

COMPONENT VIDEO OUT (Y Cr Cb) Jacks: Jacks on the back of the DVD Player that send high-quality video to a TV that has Component Video In jacks.

Dolby Digital: A surround sound system that provides 5.1 channel sound as used in movie theaters.

Letterbox: A TV Aspect setting (4:3). Displays the video in full-width, with black bars at the top and bottom of the TV screen. This format is used often when you see a movie in a theater. If the Disc does not include a letterbox format, selecting Letterbox may have no effect. (For example, some DVDs are two-sided, with one side playing in Letterbox and the other side playing in a normal format.)

Pan & Scan: A TV Aspect setting (4:3). Displays the video with full-height picture, with one or both sides of the picture trimmed to fit your TV screen.

Remote Control: The small electronic unit that came with your DVD Player; allows you to operate your DVD Player from a distance.

S-Video: Produces a clearer picture by sending separate signals for the luminance and the color. If you connect an optional S-Video cable, you will not need to use the supplied yellow video cable. You can use S-Video only if your TV has an S-Video In jack.

VIDEO OUT Jack: Yellow jack on the rear of the DVD Player that sends video to a TV. Use the supplied yellow video cable to make this connection.

Wide: A TV Aspect setting (16:9). Displays the video appropriately when you connect the DVD Player to a widescreen TV.

44 Helpful Hints

The DVD Player has no power.

- Make sure the power cord is connected completely to an AC (alternating current) outlet.
- Press STANDBY-ON to turn on the Player. "P-ON" will appear briefly on the display panel as the power turns on.

The remote control will not operate the DVD Player.

- Aim the remote control directly at the DVD Player's remote sensor. *Details are on page 18.*
- Remove all obstacles between the remote control and the DVD Player.
- Inspect and/or replace the batteries in the remote control. *Details are on page seven.*
- Use the remote control within 23 feet of the DVD Player.

No picture

- Make sure the video cable is connected correctly. You may connect either the yellow video cable (supplied), an optional S-Video cable, or optional component video cables. You only need one video connection between the DVD Player and the TV. *Details are on pages 8-14.*
- Make sure the TV is set to the correct Video channel (AUX IN, A/V IN, Auxiliary In, EXT or External In, Component Video In, S-Video In, etc.). These channels usually are located near channel 00. Check your TV owner's manual for details. Or, go to the lowest TV channel (01 or 02) and change channels downward until you see the DVD logo or DVD playback on the TV screen.
- Insert a Disc that is playable on this DVD Player. *Details are on page six.*

Disc cannot play.

- Insert a playable Disc. *Details are on page six.*
- Place the Disc correctly in the recesses in the Disc tray. If the Disc is one-sided, place the Disc in the tray with the label facing up and the shiny side facing down. If the Disc is two-sided, make sure the label of the side you want to play is facing up. *Details are on page 15.*
- Clean the Disc. *Details are on page 43.*
- Check the Parental controls and adjust if necessary. *Details are on pages 34-35.*

No sound

- Connect the audio cables firmly. Make sure the cables are connected to the AUDIO IN jacks on the TV or audio equipment. *Details are on pages 10-13.*
- Check the Audio Settings of the DVD Player. *Details are on page 37.*
- Turn on the power of the audio equipment and make sure it is set to the correct channel or "source", usually Auxiliary IN. Refer to the owner's manual of the audio equipment for details.
- Check the Audio Settings of the Disc. For example, you may have selected "soundtrack" playback on a DVD. Only the music of the movie will play, not the characters' dialog; music might not be recorded throughout the entire DVD. *Details are on page 31.*

Distorted picture

- Connect the DVD Player directly to the TV. *Details are on page eight.*
- There are some cases where the picture may be distorted slightly and briefly; this is not a malfunction of the DVD Player.

You cannot change the camera angle.

- The DVD might not contain segments recorded from different camera angles. See if multiple angles are available by referring to the DVD case or menu for more information. *Details are on page 32.*

You cannot change the audio or subtitle language.

- The DVD does not contain audio or subtitles in the desired language. Not all DVDs contain audio or subtitles in multiple languages. See if other languages are available. *Details are on pages 31-32.*

An "X" appears on the TV screen, prohibiting an operation.

- You cannot access the current feature at the current time or the feature is not available on the Disc. For example, some menus or features can be accessed or changed only when Disc play is stopped, while some are available only during playback. Check the instructions for accessing the feature before trying again. *Details are on page five.*

The DVD Player turns off after 35 minutes.

- If AUTO POWER OFF is activated, the Player turns off if play stops for more than 35 minutes and you press no buttons on the remote or the Player. When you receive the Player, the factory has set AUTO POWER OFF to ON. *Details are on pages 38-39.*

A large DVD logo appears on the TV screen.

- The DVD logo will appear on the TV screen when you stop Disc play. The logo will appear on the screen for 35 minutes, then the Player will turn off as described above. To prevent damage to your TV's picture tube, avoid leaving the DVD logo on the TV screen. Turn off the DVD Player when it is not in use. A prolonged still image, including TV station identification logos or video games, may damage your TV picture tube.

Product Type

Digital Video Disc Player

Frequency Response

DVD (linear sound): 20 Hz to 22 kHz (sample rate: 48 kHz)
20 Hz to 44 kHz (sample rate: 96 kHz)
Audio CD: 20 Hz to 20 kHz (JEITA)

Signal-to-Noise Ratio (S/N Ratio)

Audio CD: 120 dB JEITA

Dynamic Range

DVD (linear sound): 102 dB
Audio CD: 99 dB (JEITA)

Total Distortion Factor

Audio CD: 0.005% (JEITA)

Wow and Flutter

Below the measurement limitation ($\pm 0.001\%$ W PEAK) (JEITA)

Power Requirement

120V AC $\pm 10\%$, 60 Hz $\pm 0.5\%$

Connections

S-Video out	Mini DIN 4-pin jack (75 Ω)
Video out	One pin jack, 1 Vpp (75 Ω)
Coaxial digital out	One pin jack, 500m Vpp (75 Ω)
Audio out	Two pin jacks (one left channel, one right channel) 2 Vrms (100 k Ω)
Component video out	One pin jack (Y), 1 Vpp (75 Ω) Two pin jacks (Cb and Cr), 700m Vpp (75 Ω)

Power Consumption

Power on: 11 W
Power off: 3.9 W

Operating Temperature

41°F (5°C) to 104°F (40°C)

Relative Humidity

30% to 80%

Dimensions

17-1/8" (W) x 2-15/16" (H) x 8-5/16" (D)
(360 mm x 75 mm x 211 mm)

Weight

4.42 lbs. (2.0 kg.)

NOTE: Designs and specifications are subject to change without notice.

46 Limited Warranty

Digital Video Disc Player

90 days Free Product Exchange / 91 days—One Year Reduced-Cost Exchange

WHO IS COVERED?

You must have proof of the date of purchase to exchange your product. A sales receipt or other document showing the date that you purchased the product is considered such proof.

WHAT IS COVERED?

Warranty coverage begins the day you buy your product. For 90 days thereafter, you may exchange the defective product for a free new or renewed product through Magnavox.

From 91 days to one year from the date of purchase, you will pay a preset exchange fee to obtain a new or renewed product. Follow the exchange procedures on the next page. This exchange opportunity ends one year after the date of purchase. The replacement product is covered only for the warranty period of the original product. When the warranty on the original product expires, the warranty on all replaced products also expires.

When it is necessary for you to ship the product to Magnavox for exchange, you will pay the shipping costs for shipment to Magnavox. Magnavox will pay the shipping costs when returning a product to you.

WHAT IS EXCLUDED?

Your warranty does not cover:

- shipping charges to return defective product.
- labor charges for installation or setup of the product, adjustment of customer controls on the product, and installation or repair of antenna systems outside of the product.
- product repair and/or part replacement because of improper installation, abuse, neglect, misuse, accident, unauthorized repair or other cause not within the control of Magnavox.
- a product that requires modification or adaptation to enable it to operate in any country other than the country for which it was designed, manufactured, approved and/or authorized, or repair of products damaged by these modifications.
- incidental or consequential damages resulting from the product. (Some states do not allow the exclusion of incidental or consequential damages, so the above exclusion may not apply to you. This includes, but is not limited to, prerecorded material, whether copyrighted or not copyrighted.)
- a product used for commercial or institutional purposes (including but not limited to rental purposes).

WHERE IS EXCHANGE AVAILABLE?

Warranty exchange is available in all countries where the product is officially distributed by Magnavox. In countries where Magnavox does not distribute the product, the local Magnavox service organization will attempt to exchange the product, although there may be a delay if the appropriate product is not readily available.

MAKE SURE YOU KEEP...

Please keep your sales receipt or other document showing proof of date of purchase. Attach it to the owner's manual and keep both nearby. Also keep the original box and packing material in case you need to return your product.

BEFORE EXCHANGING THE PRODUCT...

Please check your owner's manual before exchanging the product. Adjustments of the controls discussed there may save you time and money.

LIMITATION OF LIABILITY AND REMEDY...

MAGNAVOX IS NOT LIABLE UNDER ANY CIRCUMSTANCES FOR ANY DIRECT, INDIRECT, SPECIAL, INCIDENTAL, OR CONSEQUENTIAL DAMAGES, HOWSOEVER INCURRED, EVEN IF NOTIFIED OF THE POSSIBILITY OF SUCH DAMAGES.

TO THE EXTENT PERMITTED BY LOCAL LAW, THE REMEDIES PROVIDED IN THIS WARRANTY STATEMENT ARE YOUR SOLE AND EXCLUSIVE REMEDY.

THIS LIMITED WARRANTY GIVES YOU SPECIFIC LEGAL RIGHTS, AND YOU MAY ALSO HAVE OTHER RIGHTS WHICH VARY FROM STATE/PROVINCE TO STATE/PROVINCE.

TO EXCHANGE YOUR PRODUCT IN THE U.S.A., PUERTO RICO, OR U.S. VIRGIN ISLANDS...

FOLLOW THE INSTRUCTIONS STATED PREVIOUSLY IN THE "WHAT IS COVERED" SECTION, OR REFER TO THE EXCHANGE INSTRUCTIONS ON THE NEXT PAGE. IN THE U.S.A., PUERTO RICO, AND U.S. VIRGIN ISLANDS, ALL IMPLIED WARRANTIES, INCLUDING THE IMPLIED WARRANTIES OF NON-INFRINGEMENT, MERCHANTABILITY AND FITNESS FOR A PARTICULAR PURPOSE, ARE SPECIFICALLY DISCLAIMED, AND TO THE EXTENT INCONSISTENT WITH LAW OF THE LOCALITY OF THE USER, LIMITED IN DURATION TO THE DURATION OF THIS EXPRESS WARRANTY. BECAUSE SOME STATES DO NOT ALLOW LIMITATIONS ON HOW LONG AN IMPLIED WARRANTY MAY LAST, THIS LIMITATION MAY NOT APPLY TO YOU.

TO EXCHANGE A PRODUCT IN CANADA...

Please contact Magnavox at:

1-800-705-2000

In Canada, this warranty is given in lieu of all other warranties. There are no other warranties, express or implied, including any implied warranties of merchantability or fitness for a particular purpose.

REMEMBER...

Please record below the model and serial numbers found on the product. Also, please fill out and mail your warranty registration card promptly. It will be easier for us to notify you if necessary.

MODEL # _____

SERIAL # _____

Magnavox, P.O. Box 520890, Miami, FL 33152 (402) 536-4171

EL6505E004 / 11-02

Limited Warranty (cont'd) 47

EXCHANGE INSTRUCTIONS

To exchange your product with Magnavox (per the warranty conditions stated previously), remember:

- If you exchange the product within 90 days of the original purchase, there is no cost to you.*
- If you exchange the product more than 90 days after but less than one year after the day of original purchase, contact Magnavox at 1-800-705-2000 to determine the preset cost for exchange.
- If you do not have your original sales receipt, or if you have any questions, call Magnavox at 1-800-705-2000.

To obtain a replacement product from Magnavox:

1. Contact Magnavox at 1-800-705-2000 to determine the cost for exchange.
2. Complete the Exchange Form below.
3. Pack the product and its accessories in the original box or a suitable alternative. You will receive replacement accessories with your replacement product. For packing details, call Magnavox at 1-800-705-2000.
4. Put the completed Exchange Form, a copy of the original sales receipt, and the proper payment amount into an envelope. DO NOT SEND CASH. Do not staple or clip these items together. Label the envelope "Return Documents Enclosed." Place this envelope in the box with the product.
5. Seal the box with packing tape and return the product via United Parcel Service (UPS), insured and freight prepaid, to the address provided by Magnavox. For details, call 1-800-705-2000. A replacement will be sent to you via UPS within 48 business hours of Magnavox' receipt of the product.

**When it is necessary for you to ship the product to Magnavox for exchange, you will pay the shipping costs for shipment to Magnavox. Magnavox will pay the shipping costs when returning a product to you.*

EXCHANGE FORM

Your Address (street address to which replacement should be delivered, no P.O. boxes allowed):

Name: _____

Street Address: _____

Apt. #: _____

City: _____

State/Province: _____

Zip Code/Postal Code: _____

Phone (day): _____

Phone (night): _____

Exchange Fee: _____ + Sales Tax: _____ = Total: _____

Method of Payment: (Check one. Please, no cash or CODs.)

_____ Check/Money order Check/Money order No. _____

	Account number	Expiration date
_____ American Express	_____	_____
_____ Visa	_____	_____
_____ Novus/Discover	_____	_____
_____ Mastercard	_____	_____

Signature: _____

Detailed reason for return, use additional paper if necessary: _____

Model Number _____ Serial Number _____

Remember, the return box should include the following:

- The product,
- Accessories supplied with the product, and
- Completed Exchange Form and sales receipt,
- Payment, if applicable.

48 Index

- ac power cord19
- angle button17, 32
- arrow buttons16
- audio button17, 31
- audio cd6, 24
- audio controls37
- audio out jacks10-13, 19
- a-b repeat26
- a-b repeat button17, 26

- batteries7
- bit rate33
- black level42

- camera angle32
- chapters25
- clear button17
- coaxial jack14, 19
- color systems6
- component video out jacks12, 19
- connections8-14
- contents, table of3
- controls, remote16-17

- disc menus20
- disc tray15, 18
- display button17, 33
- display controls38-39
- display panel18
- display screens33
- dvd video6

- fast forward button16, 22
- front panel18

- glossary43
- group26-27, 30

- helpful hints44
- hookups
 - component video12
 - rf modulator9
 - s-video11
 - stereo13-14
 - tv9-14
 - video10
- JPEG29-30

- language controls40-41

- maintenance43
- marker button17, 36
- markers36
- menu button16, 20
- menus5, 20
- mode button17, 27-28, 42
- MP329-30

- number buttons17

- ok button16
- on-screen display33
- open/close button15, 16, 18

- parental34-35
- password34
- pause button16, 21, 23
- play button15-16, 18
- playing15
- power cord19
- program27

- random28
- rear panel19
- region codes6
- remote control
 - buttons16-17
 - sensor18
 - using7
- repeat button17, 26
- repeat playback26
- resume on21
- return button16
- reverse button16, 22

- safety precautions4
- search mode button17, 24-25
- searching22
- setup button16, 34-35, 37-41
- skip buttons16, 24
- slow motion23
- specifications48
- standby-on button16, 18
- step-by-step playback21
- stereo sound mode31
- still picture21
- stop button16, 18
- subtitle button17, 32
- s-video out jack11, 19

- table of contents3

- time search25
- title button16, 20
- title menu20
- titles20, 25
- tracks24

- video out jack9-10, 14, 19
- virtual surround42

- warranty46-47

- "x"5

- zoom button16, 23



This owner's manual is made of recyclable materials. Remember to recycle!
IB8420E002 Printed In China
0VMN03601A / E5770UD *****

Free Manuals Download Website

<http://myh66.com>

<http://usermanuals.us>

<http://www.somanuals.com>

<http://www.4manuals.cc>

<http://www.manual-lib.com>

<http://www.404manual.com>

<http://www.luxmanual.com>

<http://aubethermostatmanual.com>

Golf course search by state

<http://golfingnear.com>

Email search by domain

<http://emailbydomain.com>

Auto manuals search

<http://auto.somanuals.com>

TV manuals search

<http://tv.somanuals.com>