

## ZC320MW8B/F7

### DIGITAL VIDEO DISC RECORDER



**THANK YOU FOR CHOOSING MAGNAVOX.**

#### **NEED HELP FAST?**

READ YOUR QUICK GUIDE AND/OR OWNER'S MANUAL FIRST FOR QUICK TIPS THAT MAKE USING YOUR MAGNAVOX PRODUCT MORE ENJOYABLE.

IF YOU HAVE READ YOUR INSTRUCTIONS AND STILL NEED ASSISTANCE, YOU MAY ACCESS OUR ONLINE HELP AT [WWW.MAGNAVOX.COM/SUPPORT](http://WWW.MAGNAVOX.COM/SUPPORT) OR CALL **1-800-605-8610** WHILE WITH YOUR PRODUCT.

**INSTRUCCIONES EN ESPAÑOL INCLUIDAS.**



# SAFETY INFORMATION

## Safety Instructions

The model and serial numbers of this unit may be found on the cabinet.  
You should record and retain those numbers for future reference.

Model No.: \_\_\_\_\_

Serial No.: \_\_\_\_\_

**WARNING:** TO REDUCE THE RISK OF FIRE OR ELECTRIC SHOCK, DO NOT EXPOSE THIS APPARATUS TO RAIN OR MOISTURE. APPARATUS SHALL NOT BE EXPOSED TO DRIPPING OR SPLASHING AND NO OBJECTS FILLED WITH LIQUIDS, SUCH AS VASES, SHALL BE PLACED ON THE APPARATUS.



**CAUTION**  
**RISK OF ELECTRIC SHOCK**  
**DO NOT OPEN**



### CAUTION:

TO REDUCE THE RISK OF ELECTRIC SHOCK, DO NOT REMOVE COVER (OR BACK). NO USER SERVICEABLE PARTS INSIDE. REFER SERVICING TO QUALIFIED SERVICE PERSONNEL.



The lightning flash with arrowhead symbol, within an equilateral triangle, is intended to alert the user to the presence of uninsulated "dangerous voltage" within the product's enclosure that may be of sufficient magnitude to constitute a risk of electric shock to persons.



The exclamation point within an equilateral triangle is intended to alert the user to the presence of important operating and maintenance (servicing) instructions in the literature accompanying the appliance.



The symbol for CLASS II (Double Insulation)

The important note is located on the rear or bottom of the cabinet.

## IMPORTANT SAFETY INSTRUCTIONS

1. Read these instructions.
2. Keep these instructions.
3. Heed all warnings.
4. Follow all instructions.
5. Do not use this apparatus near water.
6. Clean only with dry cloth.
7. Do not block any ventilation openings. Install in accordance with the manufacturer's instructions.
8. Do not install near any heat sources such as radiators, heat registers, stoves, or other apparatus (including amplifiers) that produce heat.
9. Do not defeat the safety purpose of the polarized or grounding-type plug. A polarized plug has two blades with one wider than the other. A grounding type plug has two blades and a third grounding prong. The wide blade or the third prong are provided for your safety. If the provided plug does not fit into your outlet, consult an electrician for replacement of the obsolete outlet.
10. Protect the power cord from being walked on or pinched particularly at plugs, convenience receptacles, and the point where they exit from the apparatus.
11. Only use attachments/accessories specified by the manufacturer.
12. Use only with the cart, stand, tripod, bracket, or table specified by the manufacturer, or sold with the apparatus. When a cart is used, use caution when moving the cart/apparatus combination to avoid injury from tip-over.
13. Unplug this apparatus during lightning storms or when unused for long periods of time.
14. Refer all servicing to qualified service personnel. Servicing is required when the apparatus has been damaged in any way, such as power-supply cord or plug is damaged, liquid has been spilled or objects have fallen into the apparatus, the apparatus has been exposed to rain or moisture, does not operate normally, or has been dropped.



### FCC WARNING

This equipment may generate or use radio frequency energy. Changes or modifications to this equipment may cause harmful interference unless the modifications are expressly approved in the manual. The user could lose the authority to operate this equipment if an unauthorized change or modification is made.

### RADIO-TV INTERFERENCE

This equipment has been tested and found to comply with the limits for a Class B digital device, pursuant to Part 15 of the FCC Rules. These limits are designed to provide reasonable protection against harmful interference in a residential installation. This equipment generates, uses, and can radiate radio frequency energy and, if not installed and used in accordance with the instructions, may cause harmful interference to radio communications. However, there is no guarantee that interference will not occur in a particular installation. If this equipment does cause harmful interference to radio or television reception, which can be determined by turning the equipment off and on, the user is encouraged to try to correct the interference by one or more of the following measures:

- 1) Reorient or relocate the receiving antenna.
- 2) Increase the separation between the equipment and receiver.
- 3) Connect the equipment into an outlet on a circuit different from that to which the receiver is connected.
- 4) Consult the dealer or an experienced radio/TV technician for help.

# SAFETY INFORMATION

**This Class B digital apparatus complies with Canadian ICES-003.**

**Cet appareil numérique de la classe B est conforme à la norme NMB-003 du Canada.**

Disconnect the mains plug to shut off when find trouble or not in use. The mains plug shall remain readily operable.

**CAUTION:** Danger of explosion if battery is incorrectly replaced. Replace only with the same or equivalent type.

**WARNING:** Batteries (Battery pack or battery installed) shall not be exposed to excessive heat such as sunshine, fire or the like.

## LASER SAFETY

This apparatus employs a laser. Only a qualified service person should remove the cover or attempt to service this apparatus, due to possible eye injury.

**CAUTION:** Use of controls or adjustments or performance of procedures other than those specified herein may result in hazardous radiation exposure.

**CAUTION:** Visible and invisible laser radiation when open and interlocks defeated. Do not stare into beam.

**LOCATION:** Inside, near the deck mechanism.

## IMPORTANT COPYRIGHT INFORMATION

Unauthorized copying, broadcasting, public performance and lending of discs are prohibited. This item incorporates copy protection technology that is protected by U.S. patents and other intellectual property rights of Rovi Corporation. Reverse engineering and disassembly are prohibited.

Do not place the unit on the furniture that is capable of being tilted by a child and an adult leaning, pulling, standing or climbing on it. A falling unit can cause serious injury or even death.

## To Avoid the Hazards of Electrical Shock and Fire

- Do not handle the power cord with wet hands.
- Do not pull on the power cord when disconnecting it from an AC outlet. Grasp it by the plug.
- Do not put your fingers or objects into the unit.

## Location and Handling

- Do not install the unit in direct sunlight, near strong magnetic fields, or in a place subject to dust or strong vibration.
- Avoid a place with drastic temperature changes.
- Install the unit in a horizontal and stable position. Do not place anything directly on top or bottom of the unit. Depending on your external devices, noise or disturbance of the picture and/or sound may be generated if the unit is placed too close to them. In this case, please ensure enough space between the external devices and the unit.
- Depending on the environment, the temperature of this unit may increase slightly. This is not a malfunction.
- Be sure to remove the disc and unplug the AC power cord from the outlet before carrying the unit.

## Dew Condensation Warning

- Dew condensation may form inside the unit in the following conditions. If so, do not use this unit at least for a few hours until its inside gets dry.
  - The unit is moved from a cold place to a warm place.
  - Under conditions of high humidity.
  - After heating a cold room.

## Note about Recycling

- This unit's packaging materials are recyclable and can be reused. Please dispose of any materials in accordance with your local recycling regulations.
- Batteries should never be thrown away or incinerated but disposed of in accordance with your local regulations concerning chemical wastes.
- For product recycling information, please visit - [www.magnavox.com](http://www.magnavox.com)



## Notice for Progressive Scan Output

- Consumers should note that not all high definition television sets are fully compatible with this product and may cause artifacts to be displayed in the picture. In case of picture problems with 480 progressive scan output, it is recommended that the user switch the connection to the 'standard definition' output. If there are questions regarding your TV set compatibility with this 480p DVD recorder, please contact our customer service center.

# SAFETY INFORMATION

## Supplied Accessories

Remote Control (NB886UD) with AA (1.5V) battery x 2

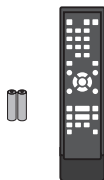

RCA audio/video cables

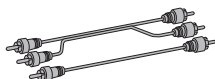

Owner's Manual

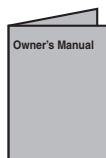

Quick Start Guide



## Cleaning discs

- When a disc becomes dirty, clean it with a cleaning cloth. Wipe the disc from the center to out. Do not wipe in a circular motion.
- Do not use solvents such as benzene, thinner, commercially available cleaners, detergent, abrasive cleaning agents or antistatic spray intended for analog records.

## Cleaning the disc lens

- If this unit still does not perform properly although you refer to the relevant sections and to "TROUBLESHOOTING" in this owner's manual, the laser optical pickup unit may be dirty. Consult your dealer or an Authorized Service Center for inspection and cleaning of the laser optical pickup unit.

## Disc handling

- Handle the discs so that fingerprints and dust do not adhere to the surfaces of the discs.
- Always store the disc in its protective case when it is not used.

## IR signal check

If the remote control does not work properly, you can test if the remote control sends out the infrared signal with a digital camera (including built-in camera of cellular phone). It will help to define the cause of malfunction.

### With a digital camera (including built-in camera of cellular phone):

Direct a digital camera to remote control, press and hold a button on remote control. If infrared light appears through digital camera, the remote control is working.



## Maintenance

### Servicing

- Please refer to relevant topics on "TROUBLESHOOTING" on pages 77-79 before returning the product.
- If this unit becomes inoperative, do not try to correct the problem by yourself. There are no user-serviceable parts inside. Turn the unit to the standby mode, unplug the power plug and please call our help line mentioned on the front page to locate an Authorized Service Center.

### Cleaning the cabinet

- Wipe the front panel and other exterior surfaces of the unit with a soft cloth.
- Never use a solvent, thinner, benzene or alcohol to clean the unit. Do not spray insecticide liquid near the unit. Such chemicals may discolor the surface or damage the unit.

## Trademark Information



Manufactured under license from Dolby Laboratories. Dolby and the double-D symbol are trademarks of Dolby Laboratories.

### **Dolby Digital Recording**

"Dolby® Digital Recording enables consumers to record high-quality video with stereo sound on recordable DVD discs. The technology, when utilized instead of PCM recording, also saves recordable disc space, allowing for higher video resolution or extended recording time on each DVD. DVDs created using Dolby Digital Recording will play back on all DVD-Video players."

**Note:** This is true when the players are compatible with actual recordable DVD discs.

© 2011 Funai Electric Co., Ltd.

All rights reserved. No part of this manual may be reproduced, copied, transmitted, disseminated, transcribed, downloaded or stored in any storage medium, in any form or for any purpose without the express prior written consent of Funai. Furthermore, any unauthorized commercial distribution of this manual or any revision hereto is strictly prohibited.

Information in this document is subject to change without notice. Funai reserves the right to change the content herein without the obligation to notify any person or organization of such changes.

**FUNAI** with the  design is a registered trademark of Funai Electric Co., Ltd. and may not be used in any way without the express written consent of Funai. All other trademarks used herein remain the exclusive property of their respective owners. Nothing contained in this manual should be construed as granting, by implication or otherwise, any license or right to use any of the trademarks displayed herein. Misuse of any trademarks or any other content in this manual is strictly prohibited. Funai shall aggressively enforce its intellectual property rights to the fullest extent of the law.

MAGNAVOX is a registered trademark of Philips Electronics North America Corporation and is used by Funai Electric Co. Ltd. and Funai Corporation, Inc. under license from Philips Electronics North America.

# CONTENTS

## Introduction

<b>SAFETY INFORMATION</b> .....	<b>2</b>
Safety Instructions .....	2
<b>FEATURES</b> .....	<b>8</b>
Symbols Used in this Owner's Manual .....	9
<b>FUNCTIONAL OVERVIEW</b> .....	<b>10</b>
Front Panel .....	10
Rear Panel .....	11
Remote Control .....	12

## Connections

<b>CONNECTION</b> .....	<b>14</b>
Connection to an External Tuner .....	14
TV Connection Overview .....	14
Connecting to a TV with Component Video Input Jacks .....	15
Connecting to a TV with an S-Video Input Jack .....	15
Connecting to a TV with Audio / Video Input Jacks .....	16
Connecting to a TV without Audio / Video Input Jacks .....	16
Digital Audio Connection .....	17

## Basic Setup

<b>BEFORE YOU START</b> .....	<b>18</b>
Finding the Viewing Channel on Your TV .....	18
Guide to On-Screen Display / Menu .....	19
Main Menu .....	21
<b>INITIAL SETTING</b> .....	<b>22</b>
<b>SETTING THE CLOCK</b> .....	<b>23</b>

## Recording

<b>INFORMATION ON DVD RECORDING</b> .....	<b>24</b>
Recordable Discs .....	24
Unrecordable Discs .....	24
Recording Mode .....	24
<b>BEFORE RECORDING</b> .....	<b>25</b>
Make Recording Compatible .....	25
Setting for Auto Chapter .....	25
<b>BASIC RECORDING &amp; ONE-TOUCH TIMER RECORDING</b> .....	<b>26</b>
<b>TIMER RECORDING</b> .....	<b>28</b>
Hints for Timer Recording .....	31
<b>SATELLITE LINK</b> .....	<b>32</b>
<b>OVERWRITING UNNECESSARY TITLE</b> .....	<b>34</b>
Overwriting from the Beginning of the Title .....	34
Overwriting in the Middle of the Title .....	34
Hints for Overwriting .....	35
<b>SETTINGS FOR AN EXTERNAL DEVICE</b> .....	<b>36</b>
Connection to an External Device .....	36
Recording from an External Device .....	37
<b>SETTING A DISC TO PROTECT</b> .....	<b>38</b>
<b>PLAYING THE DISCS ON OTHER DVD PLAYERS</b> .....	<b>39</b>
Finalizing a Disc .....	39
Auto Finalizing .....	40

## Playback

<b>INFORMATION ON PLAYBACK</b> .....	<b>41</b>
<b>BASIC PLAYBACK</b> .....	<b>43</b>
Direct Playback .....	43
Playback from the Title List .....	44
Playing Back an Audio CD and a CD-RW / -R with MP3 Files .....	46
Using the Title / Disc Menu .....	47
Pause .....	47
<b>SPECIAL PLAYBACK</b> .....	<b>48</b>
Resume Playback .....	48
Fast Forward / Fast Reverse Playback .....	48
Skipping TV Commercials During Playback.....	48
Rapid Playback.....	48
Step by Step Playback.....	49
Slow Forward / Slow Reverse Playback.....	49
Zoom.....	49
Marker Setting .....	50
Repeat Playback .....	50
Random Playback .....	51
Program Playback.....	51
<b>SEARCH</b> .....	<b>52</b>
Title / Chapter Search .....	52
Track Search .....	52
Time Search.....	53
<b>SELECTING THE FORMAT OF AUDIO AND VIDEO</b> ..	<b>54</b>
Switching Subtitles.....	54
Switching Audio Soundtrack .....	54
Switching Virtual Surround System .....	55
Switching Camera Angles .....	55
Reducing Block Noise .....	55

## Editing

<b>INFORMATION ON DISC EDITING</b> .....	<b>56</b>
Guide to a Title List.....	56
Editing Discs .....	56
<b>EDITING DISCS</b> .....	<b>57</b>
Deleting a Title.....	57
Putting Names on Titles .....	58
Setting Chapter Marks.....	59
Clearing Chapter Marks .....	60
Hiding Chapters.....	62
Setting Pictures for Thumbnails.....	63
Dividing a Title.....	64
Putting Name on Disc .....	65
Erasing Disc.....	66
Making Edits Compatible.....	67

## Function Setup

<b>LIST OF SETTINGS</b> .....	<b>68</b>
<b>SETUPS</b> .....	<b>70</b>
Playback.....	70
Display .....	73
Video .....	76

## Others

<b>TROUBLESHOOTING</b> .....	<b>77</b>
<b>LANGUAGE CODE</b> .....	<b>80</b>
<b>GLOSSARY</b> .....	<b>81</b>
<b>SPECIFICATIONS</b> .....	<b>82</b>

## Español

<b>ESPAÑOL</b> .....	<b>83</b>
----------------------	-----------

<b>LIMITED WARRANTY</b> .....	<b>Back cover</b>
-------------------------------	-------------------

# FEATURES

This unit not only plays back DVD and CD but also offers features for you to record on DVD and edit them after that. The following features are offered with this unit.

## Recording

This unit is compatible with DVD+RW/DVD-RW, which are rewritable repeatedly and DVD+R/DVD-R, which are available for recording once. Even if you choose DVD-RW/DVD-R, these discs will automatically be recorded in the DVD+VR mode.

### Up to 12 program recording:

You can program the unit to record up to 12 programs within a one-month period. Daily or weekly program recordings are also available.

### One-touch timer recording (OTR):

You can easily set a recording time as you prefer. Every time [REC] is pressed during recording, the recording time will be increased by 30 minutes up to 6 hours. The recording automatically stops when the recording time you set is reached or the disc is full.

### Left channel stereo recording:

This unit can record the sound of the left channel monaural input as left and right channels automatically (the input from the L2 jacks only).

### Automatic chapter mark setting:

Chapter marks will be put on recordings as you set before attempting to record.

### Automatic title list making:

The unit makes a title list with the index automatically.

## Playback

### Theater surround sound in your home:

When connecting the unit to an amplifier or a decoder which is compatible with Dolby Digital, you can experience the theater surround sound from discs with surround sound system.

### Quick search for what you want to watch:

You can easily find the part you want to watch using the search function. Search for a desired point on a disc by title, chapter or time.

### Virtual surround system:

You can enjoy stereophonic space through your existing 2 channel stereo system.

### Playing back MP3 files:

You can enjoy MP3 files which are recorded on CD-RW/-R.

## Editing

### Deleting titles:

You can delete titles which you do not need anymore.

### Putting names on titles:

You can put your favorite names on titles.

### Setting / clearing chapter marks:

You can set / clear chapter marks on titles.

### Hiding chapters:

To keep others from playing back some chapters without permission, you can hide chapters.

### Setting pictures for thumbnails:

You can change pictures for thumbnails.

### Dividing titles (DVD+RW/DVD-RW only):

You can divide a title into 2 or more.

### Putting name on disc:

You can put your favorite disc name.

## Compatibility

### Available for playing back discs on a regular DVD player:

Recorded discs can be played back on regular DVD players, including computer DVD drives compatible with DVD-video playback. Although DVD+R are playable on other units without finalization in most cases, it is recommended to finalize in order to stabilize the performance. For DVD-RW/-R, you need to finalize the recorded discs to play back on other DVD players.

## Others

### Progressive scan system









Unlike conventional interlace scanning, the progressive scan system provides less flickering and images in higher resolution than that of traditional television signals.



## Symbols Used in this Owner's Manual

To specify for what disc type each function is, we put the following symbols at the beginning of each item to operate.

- \* DVD-RW/-R recorded in VR mode or non compatible recording format are not playable.
- \* DVD-RW recorded in the mode other than +VR is not recordable on this unit unless you erase all contents in the disc (refer to page 66).
- \* DVD-R recorded in the mode other than +VR is not recordable on this unit.

Symbol	Description
<b>For Recording, Playing Back, and Editing</b>	
	Description refers to DVD+RW
	Description refers to DVD+R
	Description refers to DVD-RW
	Description refers to DVD-R
<b>For Playback only</b>	
	Description refers to DVD-video
	Description refers to audio CD
	Description refers to video CD with PBC function
	Description refers to video CD without PBC function
	Description refers to CD-RW/-R with MP3 files

If you do not find any of the symbols listed above under the function heading, the operation is applicable to all media.

# FUNCTIONAL OVERVIEW

## Front Panel

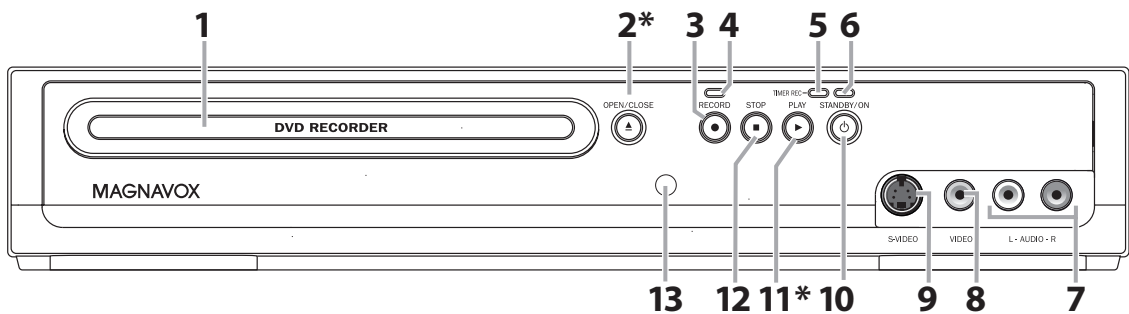

(\*) The unit can also be turned on by pressing these buttons.

### 1. Disc tray

Place a disc when it is open.

### 2. ▲ OPEN/CLOSE button\*

Press to open or close the disc tray.

### 3. ● RECORD button

- Press once to start a recording.
- Press repeatedly to start one-touch timer recording.

### 4. RECORD indicator

Lights up when recording function works.

### 5. TIMER REC indicator

- Lights up when timer programming is set.
- Lights up during one-touch timer recording.
- Flashes when all timer programmings have been finished, or when a program cannot be performed for some reason.

### 6. STANDBY/ON indicator

Lights up when power is off.

### 7. AUDIO input jacks (L2)

Use to connect external device with an RCA audio cable.

### 8. VIDEO input jack (L2)

Use to connect external device with an RCA video cable.

### 9. S-VIDEO input jack (L2)

Use to connect the S-video output of external device with an S-video cable.

### 10. STANDBY/ON button

- Press to turn on the unit, or to turn the unit to the standby mode. (To completely shut down the unit, you must unplug the AC power cord.)
- If timer programmings have been set, press to set the unit in timer-standby mode.

### 11. ► PLAY button\*

Press to start or resume playback.

### 12. ■ STOP button

- Press to stop playback or recording.
- Press to stop the proceeding timer recording in DVD.

### 13. Infrared sensor window

Receive signals from your remote control so that you can control the unit from a distance.

## Rear Panel

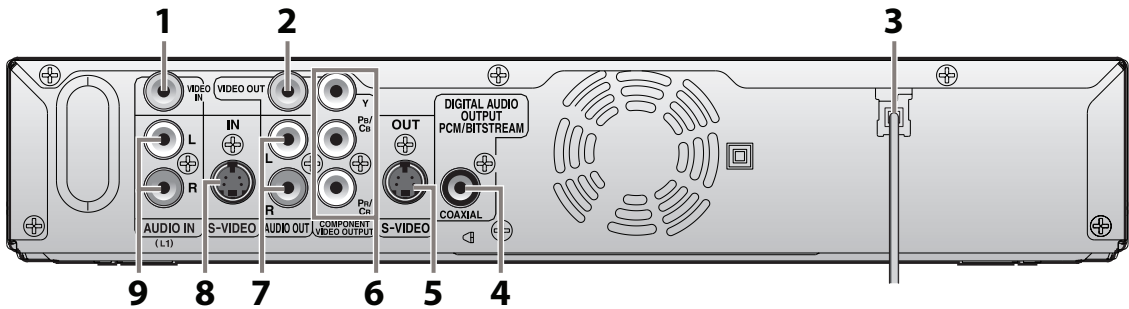

### 1. VIDEO IN jack (L1)

- Use to connect external device with an RCA video cable.

### 2. VIDEO OUT jack

- Use to connect a TV monitor, AV receiver or other device with an RCA video cable.

### 3. AC Power Cord

- Connect to a standard AC outlet to supply power to this unit.
- Unplug this cord from the AC outlet to completely shut down the unit.

### 4. COAXIAL DIGITAL AUDIO OUTPUT jack

- Use to connect an AV receiver, Dolby Digital decoder or other device with a coaxial digital input jack with a digital coaxial cable.

### 5. S-VIDEO OUT jack

- Use to connect the S-video input of a TV monitor, AV receiver or other device with an S-video cable.

### 6. COMPONENT VIDEO OUTPUT jacks

- Use to connect a TV monitor with component video inputs with a component video cable.

### 7. AUDIO OUT jacks

- Use to connect a TV monitor, AV receiver or other device with an RCA audio cable.

### 8. S-VIDEO IN jack (L1)

- Use to connect the S-video output of external device with an S-video cable.

### 9. AUDIO IN jacks (L1)

- Use to connect external device with an RCA audio cable.

### Note

- Do not touch the inner pins of the jacks on the rear panel. Electrostatic discharge may cause permanent damage to the unit.

# FUNCTIONAL OVERVIEW

## Remote Control

### Installing the Batteries in the Remote Control

Install 2 AA (1.5V) batteries matching the polarity indicated inside battery compartment of the remote control.

#### 1 Open the cover.

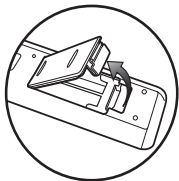

#### 2 Insert batteries.

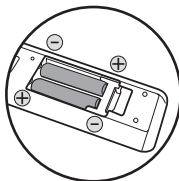

Make sure to match + and - on the batteries to the marks indicated in the battery compartment.

#### 3 Close the cover.

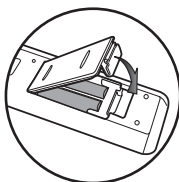

#### Note

Incorrect use of batteries can result in hazards such as leakage and bursting. Please observe the following:

- Do not mix alkaline, standard (carbon-zinc), or rechargeable (ni-cad, ni-mh, etc) batteries.
- Do not mix new and old batteries together.
- Do not use different kinds of batteries together. Although they may look similar, different batteries may have different voltages.
- Make sure that the + and - ends of each battery match the indications in the battery compartment.
- Remove batteries from battery compartment that is not going to be used for a month or more.
- When disposing of used batteries, please comply with governmental regulations or environmental public instruction's rules that apply in your country or area.
- Do not recharge, short-circuit, heat, burn or disassemble batteries.

### Using a Remote Control

Keep in mind the following when using the remote control:

- Make sure that there are no obstacles between the remote control and the infrared sensor window on the unit.
- Remote operation may become unreliable if strong sunlight or fluorescent light is shining on the infrared sensor window of the unit.
- Remote control for different devices can interfere with each other. Avoid using remote control for other device located close to the unit.
- Replace the batteries when you notice a fall off in the operating range of the remote control.
- The maximum operable ranges from the unit are as follows.
  - **Line of sight:** approx. 23 feet (7m)
  - **Either side of the center:** approx. 16 feet (5m) within 30°
  - **Above:** approx. 16 feet (5m) within 15°
  - **Below:** approx. 10 feet (3m) within 30°



16 feet (5m) 30°      23 feet (7m)      16 feet (5m) 30°

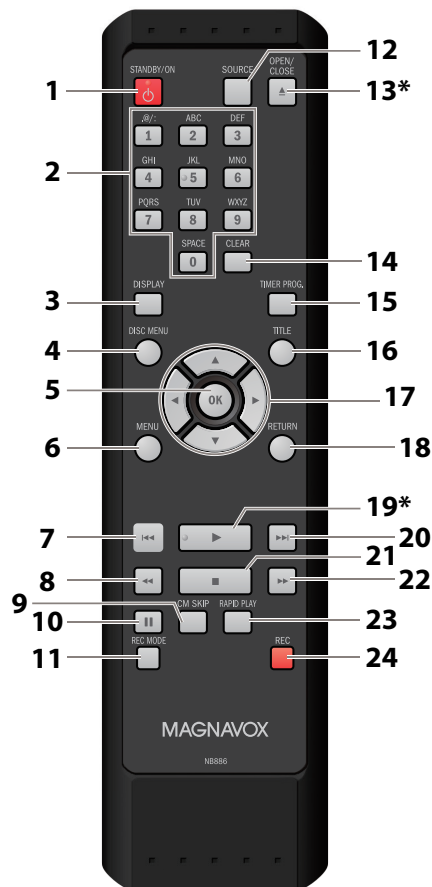

(\*) The unit can also be turned on by pressing these buttons.

## 1. STANDBY/ON button

- Press to turn on the unit, or to turn the unit to the standby mode. (To completely shut down the unit, you must unplug the AC power cord.)
- If timer programmings have been set, press to set the unit in timer-standby mode.

## 2. Number/Character buttons

- Press to select a title/chapter/track/file on display.
- Press to enter values for the settings in the main menu.
- Press to enter title names.

## 3. DISPLAY button

Press to display the display menu on or off.

## 4. DISC MENU button

Press to display the disc menu.

## 5. OK button

Press to confirm or select menu items.

## 6. MENU button

- Press to display the main menu.
- During DVD playback, press and hold for more than 3 seconds to switch the progressive scanning mode to the interlace mode.

## 7. PREV button

- During playback, press to return to the beginning of the current chapter, track or file.
- When playback is paused, press repeatedly to play back reverse step by step.

## 8. REW button

- During playback, press to fast reverse.
- When playback is paused, press to play back slow reverse.

## 9. CM SKIP button

During playback, press to skip 30 seconds.

## 10. PAUSE button

Press to pause playback or recording.

## 11. REC MODE button

Press to switch the recording mode.

## 12. SOURCE button

Press to change the L1 or L2.

## 13. OPEN/CLOSE button\*

Press to open or close the disc tray.

## 14. CLEAR button

Press to clear the password once entered or to cancel the programming for CD or to clear the selected marker number, etc.

## 15. TIMER PROG. button

Press to display the timer programming list.

## 16. TITLE button

Press to display the title list.

## 17. Cursor / / / buttons

Press to select items or settings.

## 18. RETURN button

Press to return to the previously displayed menu screen.

## 19. PLAY button\*

Press to start or resume playback.

## 20. NEXT button

- During playback, press to skip to the next chapter, track or file.
- When playback is paused, press repeatedly to play back forward step by step.

## 21. STOP button

- Press to stop playback or recording.
- Press to exit from the title list.

## 22. FFW button

- During playback, press to play back fast forward.
- When playback is paused, press to play back slow forward.

## 23. RAPID PLAY button

During playback, press to playback in a slightly faster/slower mode with keeping the audio quality.

## 24. REC button

- Press once to start a recording.
- Press repeatedly to start the one-touch timer recording.

# CONNECTION

## Read this first:

- 1) Disconnect the AC power cords of the devices from the AC outlet.
- 2) Make the connection as illustrated below.
- 3) After making all the connections, connect the AC power cords of the devices.

- Connect this unit directly to the TV. If the RCA audio/video cables are connected to a VCR, pictures may be distorted due to the copy protection system.
- **When "Progressive Scan" is set to "ON", no video signal will be output from the VIDEO OUT or S-VIDEO OUT jack.**

## Connecting to an External Tuner

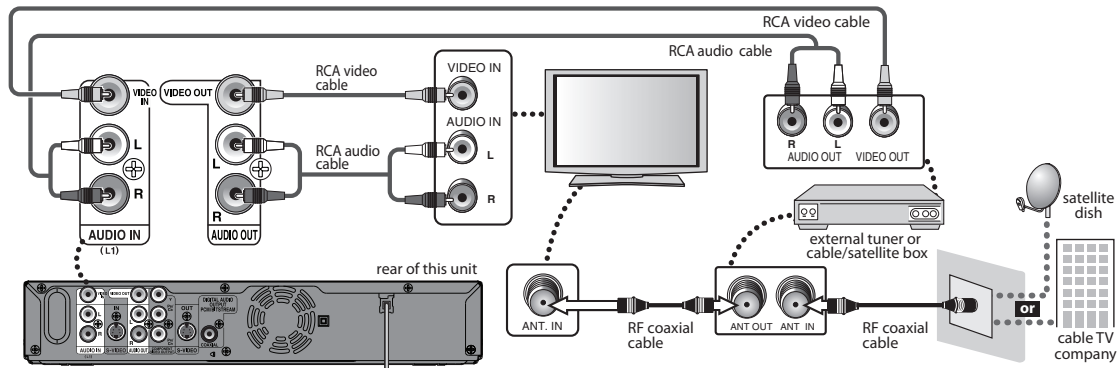

### Note

- Required cables and connecting methods differ depending on the external tuner. For more information, please contact your external tuner provider.

### With this setup:

- You can record any unscrambled channel by selecting the channel on the external tuner. Be sure that the external tuner is turned on.
- **You cannot record one channel while watching another channel.**

### Supplied cables used in this connection are as follows:

- RCA audio cable (L/R) x 1
  - RCA video cable x 1
- Please purchase the rest of the necessary cables at your local store.



## TV Connection Overview

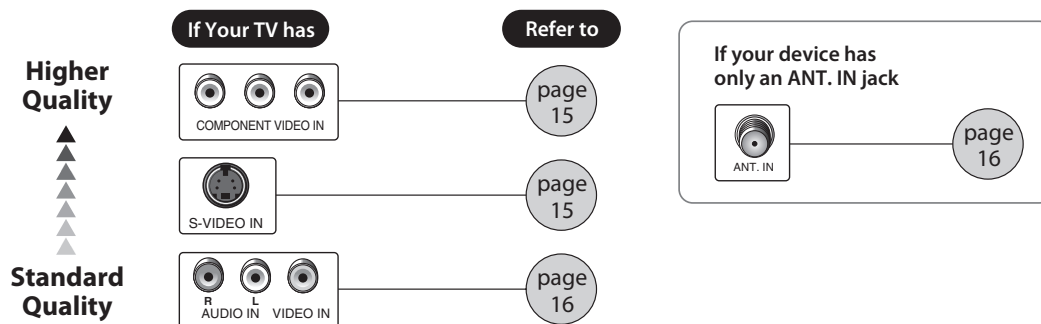

# CONNECTION

## Connecting to a TV with Component Video Input jacks

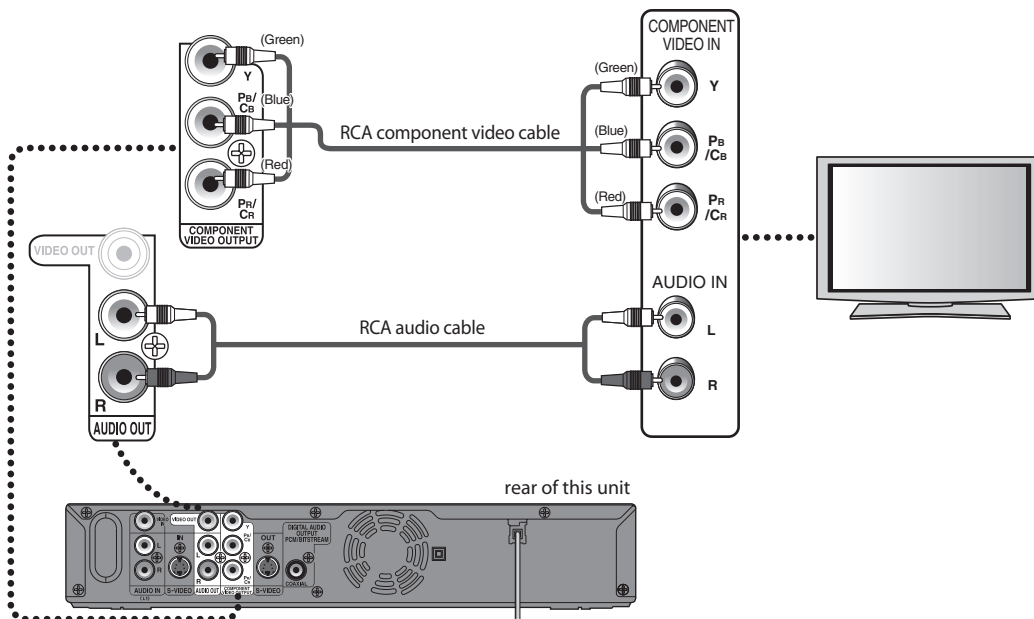

### Supplied cables used in this connection are as follows:

- RCA audio cable (L/R) x 1

Please purchase the rest of the necessary cables at your local store.

## Connecting to a TV with an S-Video Input Jack

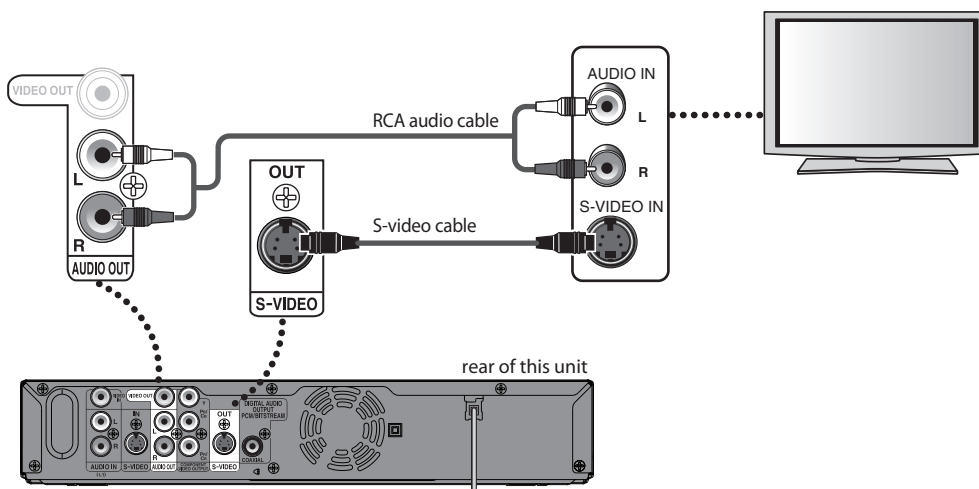

### Supplied cables used in this connection are as follows:

- RCA audio cable (L/R) x 1

Please purchase the rest of the necessary cables at your local store.

# CONNECTION

## Connecting to a TV with Audio / Video Input Jacks

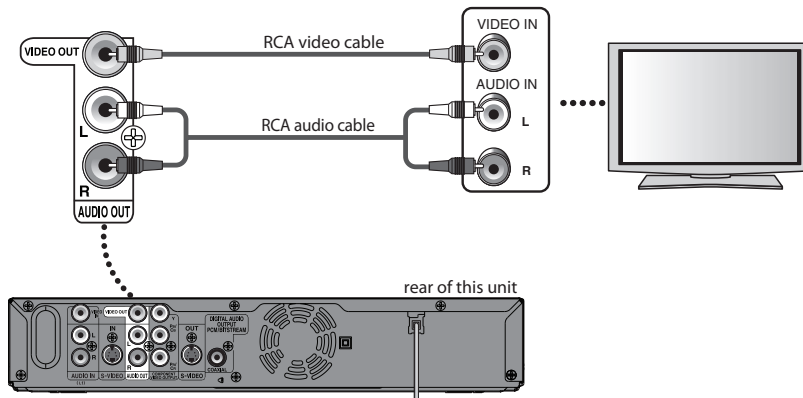

### Supplied cables used in this connection are as follows:

- RCA audio cable (L/R) x 1
- RCA video cable x 1

## Connecting to a TV without Audio / Video Input Jacks

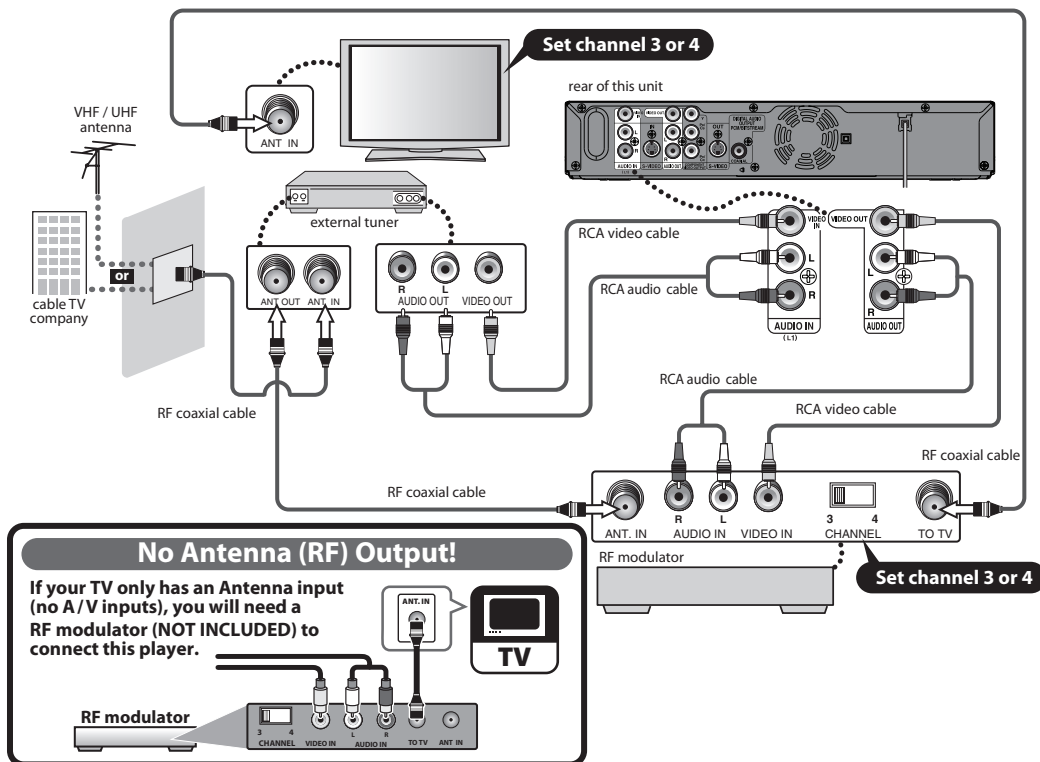

### No Antenna (RF) Output!

If your TV only has an Antenna input (no A/V inputs), you will need a RF modulator (NOT INCLUDED) to connect this player.

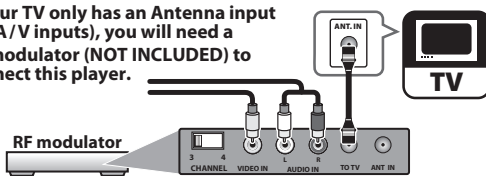

### Supplied cables used in this connection are as follows:

- RCA audio cable (L/R) x 1
- RCA video cable x 1

Please purchase the rest of the necessary cables at your local store.

### Note

- RF modulator is not supplied with this unit. You need to purchase it at your local store.
- The quality of picture may become poor if this unit is connected to an RF modulator.



## Digital Audio Connection

### Coaxial Cable Connection

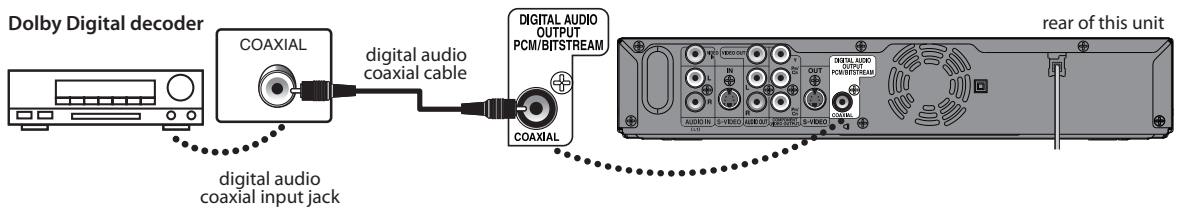

To set up "Dolby Digital" refer to pages 68 and 71-72.

Audio format (disc)	Dolby Digital Setting of this unit	Digital Output
Dolby Digital	PCM	2channel PCM
	Stream	Dolby Digital
LPCM	PCM	—
	Stream	—

↑  
**Actual Output**

#### Cables not included.

Please purchase the necessary cables at your local store.

#### Note

- The audio source on a disc in a Dolby Digital multi channel surround format cannot be recorded as digital sound by an MD or DAT deck.
- By connecting this unit to a Dolby Digital decoder, you can enjoy high-quality Dolby Digital multi channel surround sound as in movie theaters.
- Playing back a DVD using incorrect digital audio settings may generate noise distortion and also damage speakers.

## 2 Channel Analog Audio Connection

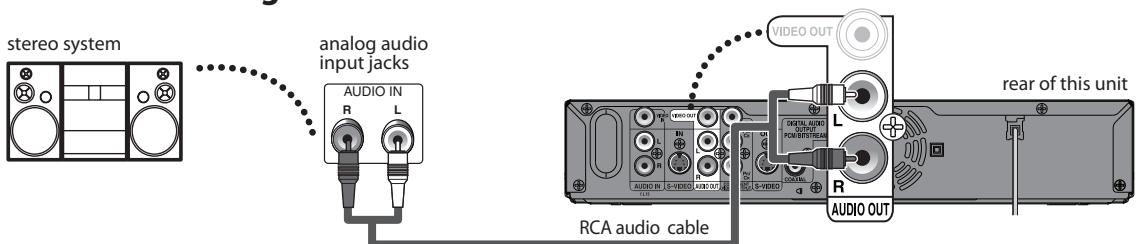

#### Supplied cables used in this connection are as follows:

- RCA audio cable (L/R) x 1

# BEFORE YOU START

## Finding the Viewing Channel on Your TV

After you have completed all the connections, you must find the viewing channel (external input channel) on your TV.

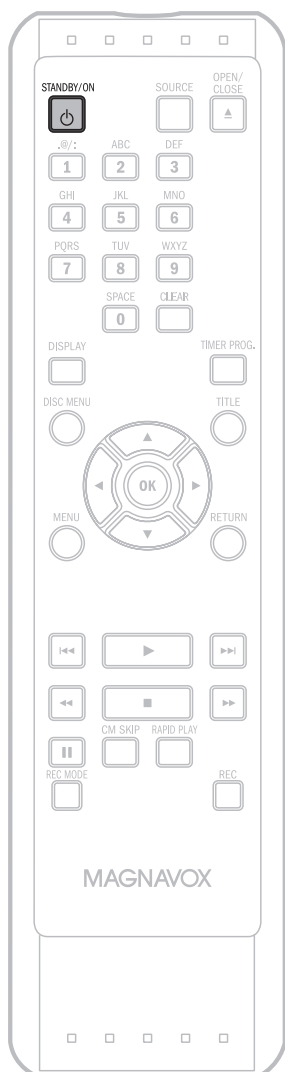

**1** After you have made all the necessary connections, press [STANDBY/ON ] to turn on the unit.

**2** Turn on your TV.

- If connected to your VCR make sure it is switched off or in standby mode before proceeding.

**3** Press "2" on the TV's remote control, then press channel down button repeatedly until you see "Initial Setup" menu.

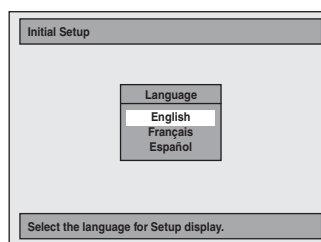

This is the correct viewing channel (external input channel) for the recorder.

- For some TVs, there may be a button on the TV's remote control that accesses the external input channel. It may be labeled "SOURCE", "AV", or "SELECT". In such case, press it repeatedly. Refer to your TV's user manual for details.
- If more than 10 minutes have passed since you have turned on the unit, you may see the MAGNAVOX screen saver instead of "Initial Setup" menu.

MAGNAVOX screen saver:



**4** Proceed to step 2 in "INITIAL SETTING" on page 22.

### Note

- Video input selection varies for different brand's models of TVs.
- Consult your TV manufacturer if none of the above is successful.

## Guide to On-Screen Display / Menu

This unit uses the following on-screen displays and menus to guide you to the easy operations. The on-screen displays give you the information on the loaded disc, the disc/file in playback etc. The menus allow you to change the various kinds of settings for playing back, recording, or editing to suit your preference.

The on-screen display changes in the following order as you press [DISPLAY].

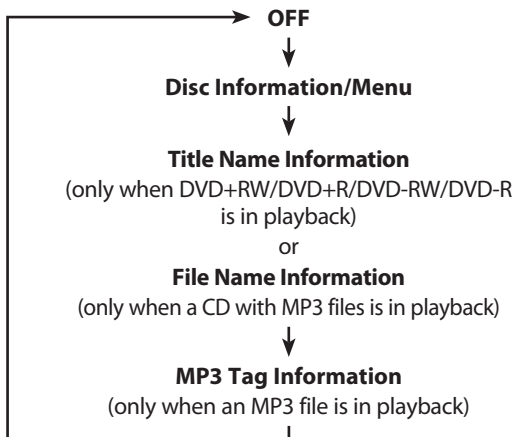

## Disc Information / Menu

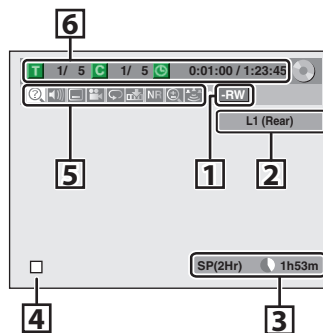

\* This is an example screen only for explanation. Displayed items vary depending on the disc you inserted.

1. Indicates a disc type.
2. Indicates the selected external input channel.
3. Indicates a recording mode and possible recording time left.
4. Indicates an operation status.
5. Each icon means:
  - : Search
  - : Audio
  - : Subtitle
  - : Angle
  - : Repeat
  - : Marker
  - : Noise Reduction
  - : Zoom
  - : Surround
6. Indicates the current title number/total number of titles, the current chapter number/total number of chapters, and time lapse of the current title playback/total duration of the title.

## Title/File Name Information

Title Name Information



File Name Information

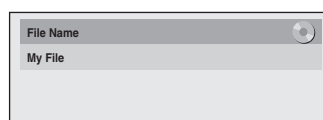

## MP3 Tag Information

- First, track name will be displayed.



- If you press **[DISPLAY]** one more time, artist name will be displayed.



- If you press **[DISPLAY]** one more time, album name will be displayed.



- If there is no artist, track or album name, "Not Available" will be displayed.

## Main Menu

Press [MENU] to display the main menu. Then use [▲ / ▼] to select a menu and press [OK] to display the menu. These menus provide entries to all main functions of the unit.

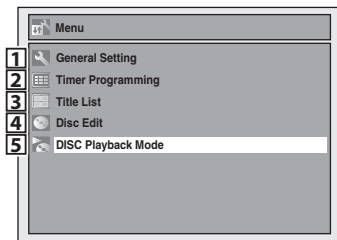

- 1. General Setting:**  
To go to general setting menu.
- 2. Timer Programming:**  
To program a timer recording.
- 3. Title List:**  
To call up the title list.
- 4. Disc Edit:**  
To set up the DVD setting.
- 5. DISC Playback Mode:**  
To set up the disc playback setting.
  - “DISC Playback Mode” is available only when an audio CD, a video CD, a CD-RW/-R with MP3 files is inserted into the unit.

## General Setting Menu

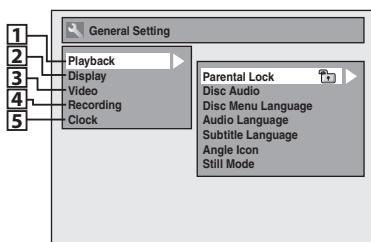

- 1. Playback:**  
To set up the unit to play back discs as you prefer.
- 2. Display:**  
To set up the screen as you prefer.
- 3. Video:**  
To set up the video setting.
- 4. Recording:**  
To set up the unit to record to discs as you prefer.
- 5. Clock:**  
To set up the clock of the unit as you need.

## Disc Edit / DISC Playback Mode

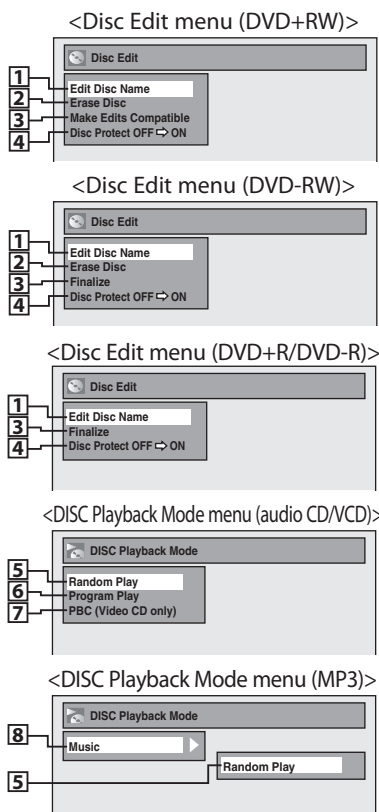

- 1. Edit Disc Name:**  
Allows you to rename the disc.
- 2. Erase Disc:** (DVD+RW/DVD-RW only)  
Allows you to erase all contents in the disc and format it.
- 3. Make Edits Compatible:** (DVD+RW only)  
Allows you to memorize the editing status on the disc if you have added or deleted chapters, or made chapters hidden on this unit, and to show the effects when playing back on the other unit.
- Finalize:** (DVD+R/DVD-RW/-R only)  
Allows you to finalize a disc containing recorded titles.
- 4. Disc Protect :**  
Allows you to protect a disc from accidental editing or recording.
- 5. Random Play:**  
Allows you to activate the random playback feature.
- 6. Program Play:** (Audio CD only)  
Allows you to activate the program playback feature.
- 7. PBC (Video CD only):**  
Allows you to select images or information on the menu screen by activating PBC (playback control) function.
- 8. Music:**  
Allows you to make setting for MP3 playback.

# INITIAL SETTING

You need to follow these steps when you turn on this unit for the first time.



**1** Follow the procedure in “Finding the Viewing Channel on Your TV” on page 18 to display “Initial Setup” menu.

**2** Use [▲ / ▼] to select your desired language, then press [OK].

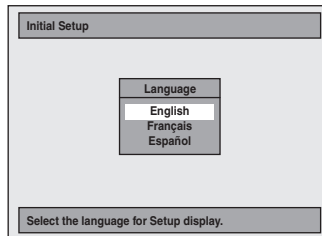

**3** Proceed to step 4 in “SETTING THE CLOCK” on page 23.

# SETTING THE CLOCK

Set the clock before you try the timer programming. Follow these steps below.

**1** Press [MENU] and use [▲ / ▼] to select "General Setting", then press [OK].  
"General Setting" menu will appear.

**2** Use [▲ / ▼] to select "Clock", then press [OK].  
"Clock Setting" menu will appear.

**3** Use [▲ / ▼] to select calendar or time, then press [OK].

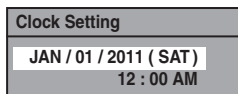

**4** Use [◀ / ▶] to select an item to set, and use [▲ / ▼] to select the contents to suit your preference, then press [OK] when you finish setting all the contents.

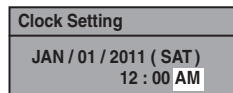

Your setting will be activated.  
The clock start counting when you press [OK].

**5** Press [MENU] to exit.

## Note





- Your setting will be canceled if you press [MENU] before pressing [OK] at step 4.
- Your clock setting will be lost if either there is a power failure or this unit has been unplugged for more than 30 seconds when you set the clock manually.
- For setting the day, year, hour, and minute, [the Number buttons] can also be used.
- You can set the built-in calendar from the year 2010 up to 2060.

# INFORMATION ON DVD RECORDING

Before you make a recording, read the following information.

## Recordable Discs

This unit can record to DVD+RW, DVD+R, DVD-RW and DVD-R.  
 DVD+R/DVD-R can only be recorded to once. DVD+RW/DVD-RW can be recorded to and erased many times.  
**DVD-RW/-R will be recorded in the DVD+VR mode automatically in this unit.**

Logos		Attributes
		8cm/12cm, single-sided, single layer disc Approx. max. recording time (SLP mode): 360 minutes (4.7GB) (for 12cm) 108 minutes (1.4GB) (for 8cm)
DVD+RW	DVD+R	
		
DVD-RW	DVD-R	

The following discs are recommended for good recording quality and are proven to be compatible with this unit. However, depending on the media condition the unit may not read the disc properly.

Verbatim	DVD+R 8x,	DVD+RW 4x,
	DVD-R 8x,	DVD-RW 2x
JVC	DVD-RW 4x	
Maxell	DVD+R 4x/8x/16x,	DVD-R 8x/16x
SONY	DVD+R 4x/8x/16x, DVD+RW 4x	
TDK	DVD+R 4x/8x/16x	

Performance of any other discs are not guaranteed.

**You can play back DVD+RW on most DVD players without finalizing. However, if you have added or deleted chapters, or made chapters hidden, you must perform "Make Edits Compatible" before being able to see those effects on other units. (Refer to page 67 for more details.) To play back discs other than DVD+RW on other DVD players, you will need to finalize.**

## Unrecordable Discs

- DVD-RW recorded in the mode other than +VR is not recordable on this unit unless you erase all contents in the disc (refer to page 66).
- DVD-R recorded in the mode other than +VR is not recordable on this unit.

## Recording Mode

You can select a recording mode among 6 options, and the recording time will depend on the recording mode you select as follows.

Disc size	Recording mode	Recording time	Video/sound quality
8cm Disc	HQ (1Hr)	18 min	☆☆☆☆☆☆ (good)
	SP (2Hr)	36 min	☆☆☆☆☆
	SPP (2.5Hr)	45 min	☆☆☆☆
	LP (3Hr)	54 min	☆☆☆
	EP (4Hr)	72 min	☆☆
	SLP (6Hr)	108 min	☆ (poor)
12cm Disc	HQ (1Hr)	60 min	☆☆☆☆☆☆ (good)
	SP (2Hr)	120 min	☆☆☆☆☆
	SPP (2.5Hr)	150 min	☆☆☆☆
	LP (3Hr)	180 min	☆☆☆
	EP (4Hr)	240 min	☆☆
	SLP (6Hr)	360 min	☆ (poor)

- The recording time is only an estimate. The actual recording time may differ.
- The audio and video quality gets poorer as the recording time becomes longer.
- Each time [REC MODE] is pressed, recording mode and its allowed recording time will be displayed.

### Note

- This unit cannot record to CD-RW or CD-R.**
- All high definition pictures will be down converted to the standard definition pictures when they are recorded on this unit.
- DVD+RW/+R, DVD-RW/-R and CD-RW/-R recorded on a personal computer or a DVD or CD recorder may not be played back if the disc is damaged or dirty or if there is condensation on the player's lens.
- If you record a disc using a personal computer, even if it is recorded in a compatible format it may not be played back because of the settings of the application software used to create the disc. (Check with the software publisher for more detailed information.)
- Since the recording is made by the VBR (variable bit rate) method, depending on the picture you are recording, the actual remaining time for recording may be a little shorter than the remaining time displayed on the TV screen.
- You cannot record copy-protected program using this unit. (Copy-protected signal is included in DVD-video or some satellite broadcasts.)
- You cannot record "copy-once only" program's on DVD.



# BEFORE RECORDING

## Make Recording Compatible



Use this feature to make unfinalized +VR mode discs recorded on other unit recordable on this unit. When you make an additional recording on this unit with "Make Recording Compatible" set to "ON", the title menu is automatically converted to our style.

- 1) Press [MENU] and use [▲ / ▼] to select "General Setting", then press [OK].  
"General Setting" menu will appear.
- 2) Use [▲ / ▼] to select "Recording", then press [OK].  
"Recording" menu will appear.
- 3) Use [▲ / ▼] to select "Make Recording Compatible", then press [OK].
- 4) Use [▲ / ▼] to select "ON" or "OFF", then press [OK].

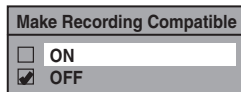

- ON:** Title list will be replaced when you make additional recordings to the discs recorded by other units.
- OFF:** Prohibiting additional record to the disc that has a title list created by other units.

- 5) Press [MENU] to exit.

## Setting for Auto Chapter

You can set a specified time for chapter marks.

- 1) Press [MENU] and use [▲ / ▼] to select "General Setting", then press [OK].  
"General Setting" menu will appear.
- 2) Use [▲ / ▼] to select "Recording", then press [OK].  
"Recording" menu will appear.
- 3) Use [▲ / ▼] to select "Auto Chapter", then press [OK].
- 4) Use [▲ / ▼] to select a desired time option, then press [OK].

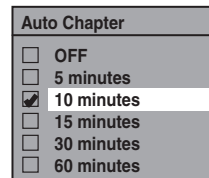

- 5) Press [MENU] to exit.

### Note

- The interval for auto chapter may be up to two minutes different from the time option you set.
- A blank chapter may be created depending on the remaining time of the disc.

# BASIC RECORDING & ONE-TOUCH TIMER RECORDING

Follow the steps to record TV programs.

This unit has no tuner system so cannot receive TV broadcasts without external tuner or such devices.

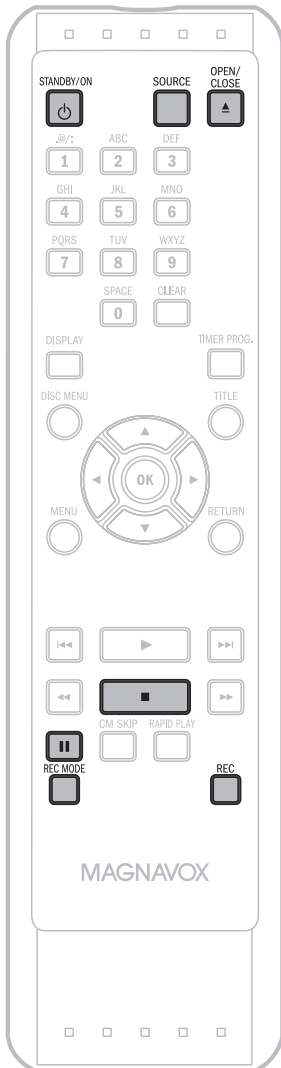

**1** Press [STANDBY/ON ].  
Turn on the TV and be sure to select the input to which the unit is connected.

**2** Press [OPEN/CLOSE ] to open the disc tray and insert your disc with its label facing up.

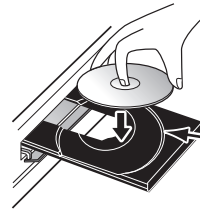

Align the disc to the disc tray guide.

\* Make sure the disc is compatible with this unit. (Refer to page 24 for the list of compatible discs.)

**3** Press [OPEN/CLOSE ] to close the disc tray.

**It may take a while to load the disc data after the disc tray closes.**

- When inserting a brand-new DVD+RW/DVD-RW, the unit automatically starts to format.
- If titles have been recorded on the disc, the title list is displayed. Press [STOP ] to exit the title list.

**4** Press [REC MODE] repeatedly to select a recording mode.  
Refer to "Recording Mode" on page 24.

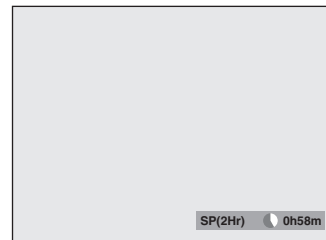

**5** Press [SOURCE] to select the appropriate external input position (L1/L2) to which your external tuner is connected. Then select the desired channel to record on the external tuner.

## 6 Press [REC] to start recording.

"●" will be displayed for 4 seconds.

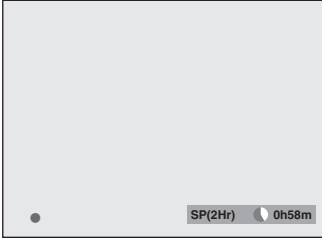

Press [PAUSE II] to pause recording.  
Press [PAUSE II] or [REC] again to restart recording.

### To set one-touch timer recording (OTR)...

This is a simple way to set the recording time in blocks of 30 minutes.

Press [REC] repeatedly until the desired recording time (30 minutes to 6 hours) appears on the TV screen.

One-touch timer recording will start.

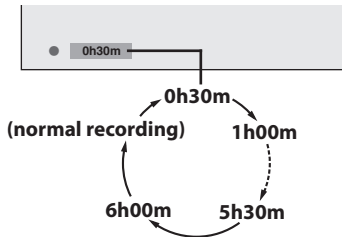

### To change the recording length during the one-touch timer recording:

Press [REC] repeatedly until the desired length appear.

### To cancel the one-touch timer recording within the specified time:

Press [STOP ■].

## 7 Press [STOP ■] to stop recording.

The recorded title will appear in the title list. (Refer to "Guide to a Title List" on page 56.) e.g.) DVD+R

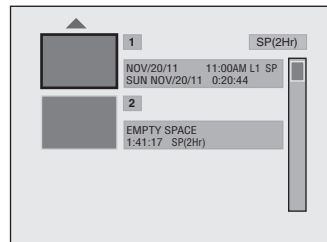
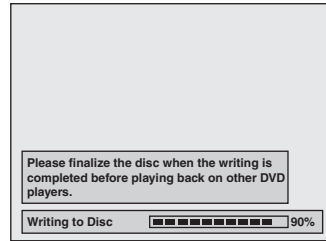

• Press [STOP ■] to exit the title list.

### Note

- When you press [REC], recording starts immediately and continues until the disc is full or you stop recording.
- This unit cannot record images as aspect ratio of 16:9. The 16:9 images will be recorded as 4:3.
- When the unit clock has not been set, the space for a date and time of title names will be blank.
- You cannot change the recording mode during the recording pause mode.
- You can change a channel to be recorded during the recording pause mode.

### Note for one-touch timer recording

- The remaining recording time will be displayed during one-touch timer recording. Press [DISPLAY] to see it on the TV screen.
- Unlike the timer recording, you can perform the following operations during one-touch timer recording.
  - Turning the power to standby to stop one-touch timer recording.
  - Using [REC] or [STOP ■] on the remote control.
- You cannot use the pause function during one-touch timer recording.
- When one-touch timer recording is finished and the power is turned to standby, the unit will switch to the timer-standby mode automatically if a timer recording has been programmed. Press [STANDBY/ON ⏻] to cancel the timer-standby mode to use the unit continuously.

# TIMER RECORDING

You can program the unit to record up to 12 programs within a month in advance. Daily or weekly program recordings are also available.

## Before recording, make sure

- Connect the external tuner to either L1 or L2 and set it to output audio/video signals when it comes to the time you want to start recording.
- Do not change the external tuner's channel while you are recording. You cannot watch one channel and record another at the same time.
- Set the clock before setting a timer programming.
- Insert a recordable disc with enough recordable space.

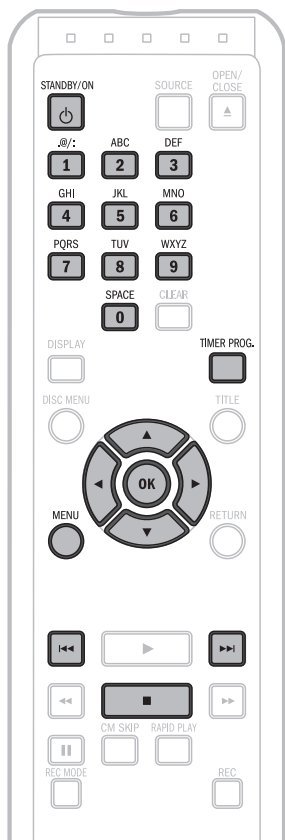

## Guide to Timer Programming Display

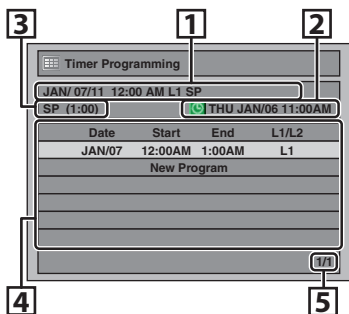

- 1 Title of a timer program (Contains date, time, selected external input position, recording mode of the program)
- 2 Current date and time
- 3 Recording mode, and length of the recording
- 4 Timer program list
- 5 Total number of pages and current page (2 pages maximum)

## 1 Press [TIMER PROG.].

## 2 Use [▲ / ▼] to select "New Program", then press [OK].

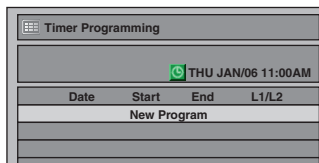

- If there are 6 or more programs, use [◀◀ / ▶▶] to change pages.

## 3 Use [▲ / ▼] to enter the date, then press [▶].

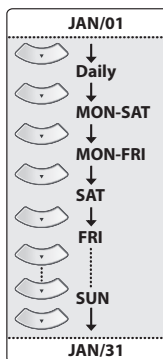

When pressing [▼] at the current date, the date will change as follows.

e.g.) January 1st

## 4 Use [▲ / ▼ / ◀ / ▶] or [the Number buttons] to enter the start and end time, then press [▶].



- You cannot make a program which recording time exceeds 12 hours.

- 5** Use [▲ / ▼] to select the appropriate external input position (L1/L2) to which your external tuner is connected, then press [▶].

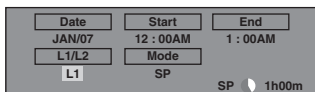

- 6** Use [▲ / ▼] to select a recording mode.

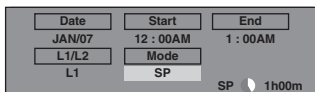

Refer to "Recording Mode" on page 24.

- You can check the remaining recordable space of the disc when you select the recording mode.



### Auto recording mode select...

When "Auto" is selected as a recording mode, the unit calculates how much time is available on the disc and selects the best recording mode available automatically to complete recording the program.

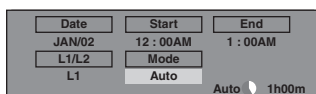

- "Auto" is only available for one program in the timer program list.
- The recording may be cut short when the available recording space of the disc is too limited.

- 7** Press [OK] when all items are entered. After displaying an instructive message for 10 seconds, timer program list will appear.

Press STANDBY-ON to Timer standby mode.  
Ensure the external source is turned to the correct channel.

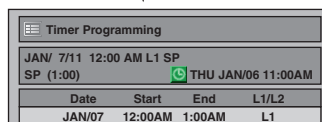

Your program setting is now stored.

- To set another program, repeat steps 2 to 7.
- To exit, press [TIMER PROG.] or [MENU].
- When 2 or more programs are overlapped, "Timer program overlapped" appears, and the overlapped program will be displayed in blue.
- To correct the timer program refer to "Checking, canceling, or correcting the timer programming information" on page 30.

- 8** Press [STANDBY/ON ⏻] to set the timer program.

TIMER REC indicator will light up on the front panel.

### Note

- If you have not set the clock yet:**  
Entry screen for the clock setting will appear instead of the timer programming list at step 1. Continue with the step 4 in "SETTING THE CLOCK" on page 23 before setting a timer programming.
- Use [◀ / ▶] to move the cursor to the left and the right in the entry screen for the timer programming.
- You cannot make a program whose recording time exceeds 12 hours.

# TIMER RECORDING

## To stop the timer recording in progress

- 1) Press [STOP ■] on the remote control.
- 2) Confirmation message will appear. Select "Yes", then press [OK].
  - To stop the timer recording immediately, press [■STOP] on the unit.

## Checking, canceling, or correcting the timer programming information

- 1) Press [STANDBAY/ON ⓪].
- 2) Press [TIMER PROG.].
- 3) Check the information.

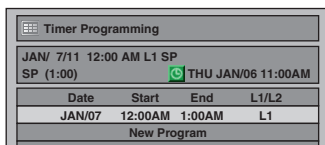

- 4-A) To delete the timer program:
  - 1 Use [▲ / ▼] to select the program you want to delete, then press [OK].
  - 2 Use [▲ / ▼] to select "Delete", then press [OK]. Confirmation window will appear.
  - 3 Use [▲ / ▼] to select "Yes", then press [OK].
- 4-B) To correct the timer program:
  - 1 Use [▲ / ▼] to select the program you want to correct, then press [OK].
  - 2 Use [▲ / ▼] to select "Program Change", then press [OK].
  - 3 Correct the timer program by using [▲ / ▼ / ◀ / ▶], then press [OK].
- 5) Press [TIMER PROG.] to exit.
- 6) Press [STANDBAY/ON ⓪] to return to the timer standby mode.

### Note

- Press [TIMER PROG.] to check the timer recording in progress. When the timer recording is proceeding, that program will be highlighted with red. In this case, you cannot select any other program.

## Putting Names on Timer Programs

- 1) In stop mode, press [TIMER PROG.].
- 2) Use [▲ / ▼] to select the program you want to edit the timer program name, then press [OK].
- 3) Use [▲ / ▼] to select "Edit Title Name", then press [OK].

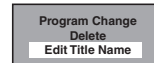

A window for entering a title name will appear.

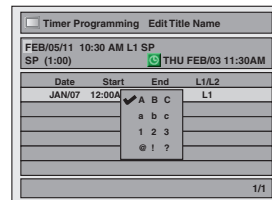

- 4) To enter a title name, follow the steps of "Guide to Edit Title Name" on page 58.
- 5) After entering a title name, press [OK].
- 6) Use [▲ / ▼] to select "Yes", then press [OK].
  - The program name is now updated.

If the timer program did not complete correctly, the error number appears in the timer programming list.

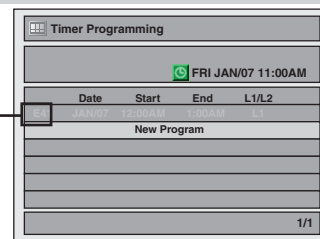







### Each error number means:

E1-22 E37-39	Recording error other than below	E41	Power failed
E24	Unrecordable disc	E42	No disc when recording
E25-26	Copy prohibited program	E43	Already 49 titles recorded
E29	Disc protected	E44	Already 254 chapters recorded
E30	Disc full	E45	Copy prohibited program
E35	PCA full *1	E46	It is impossible to record additionally on a disc recorded by other units when setting "Make Recording Compatible" to "OFF".
E36	Already finalized video format disc		
E40	Some portion has not been recorded because of program overlapping. Recording did not start at the start time.		

- E23, E27, E28, E31, E32, E33 and E34 are not displayed.
  - A program with the error number is grayed in the timer programming list.
  - Timer program with an error number will be cleared once the entry screen for the program is displayed.
- \*1 PCA is a disc's space reserved for recording test.

## Hints for Timer Recording

- If there is a power failure or this unit has been unplugged for more than 30 seconds, the clock setting and all timer programming will be lost.
- If a disc is not inserted, TIMER REC indicator flashes and timer recording cannot be performed. In some cases, TIMER REC indicator will light up momentarily around the start point as the unit attempts to record. Please insert a recordable disc.
- When all the timer recording is completed, TIMER REC indicator flashes. To play back or eject the recorded disc, press [STANDBY/ON ] first, then select the recorded title and press [PLAY >], or [OPEN/CLOSE ] to remove the disc.
- During timer recording or timer standby mode (TIMER REC indicator will light up), any operations on the unit will not be available. To make these operations available, press [STOP ] to cancel the timer recording or [STANDBY/ON >] to release timer standby mode (TIMER REC indicator will light off).
- When the starting and the ending time are the same, "Exceeds 12 hours" appears and the program setting will not be accepted.
- When the programmed starting and ending time are earlier than the current time, the setting will not be accepted.
- If the starting time is earlier and the ending time is later than the current time, the recording will start right after you press [STANDBY/ON ] at step 8 on page 29.

## The Priority of Overlapped Settings

- Timer program which has the earlier start time will be placed first in the timer program list, and be given priority over the programs with the later start time when timer programs overlap.
- When timer programs overlap, the first 2 minutes (at the longest) of the later recording will be cut off.
- When 2 or more timer programs have the same start time, the program set first will be given priority.
- A timer recording of lower priority will be canceled or start from the middle.
- Check the overlapped timer programmings and change the priority if necessary.

- **When the starting time is the same:**  
A program set previously (PROG. A) has priority.

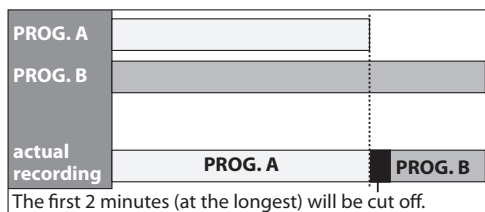

## Note for DVD recording

- When the recording time of 2 programs are overlapped, or the end time of a program and the start time of another program is the same, the first 2 minutes (at the longest) of the subsequent program will be cut off.
- If the cut-off portion comes up to 3 minute or more, this program will be displayed with error number E40 in the timer programming list.

- **When the end time of the programming currently being recorded and the start time of the subsequent program are same:**  
The beginning of the PROG. B may be cut off.

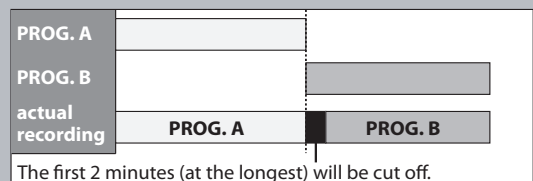

# SATELLITE LINK

You can set the unit to start recording whenever it detects the video signal from the external tuner.

## Preparing for the satellite link timer recording:

### Preparation on the tuner

- Satellite link accepts only the connection from L1 (rear) with the external tuner. (The connection from L2 cannot read any signals from the external tuner.)
- The external tuner should be equipped with some kind of timer function. Using timer function of the tuner, set it to output audio/video signals when it comes to the time you want to start recording, and stop output audio/video signals when it comes to the time you want to finish recording. Refer to the tuner's manual on how to set the timer.
- Make sure to set the satellite link standby mode when you finish setting.

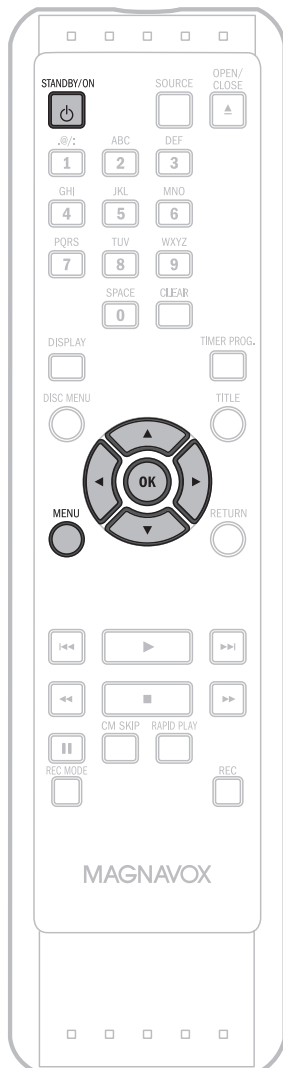

**1** Press [MENU].

**2** Use [▲ / ▼] to select "Timer Programming", then press [OK].

**3** Use [▲ / ▼] to select "Satellite Link", then press [OK].

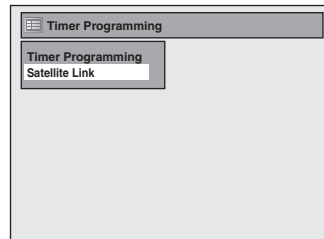

**4** Use [▲ / ▼] to select the time and recording mode, then press [OK].

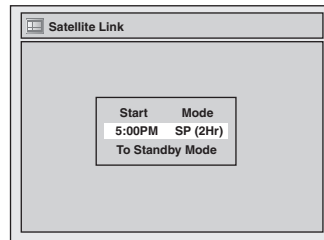

**5** Use [▲ / ▼] to set the desired starting time, then press [▶].

- The hour can be selected from 1 to 12 with AM or PM.
- Repeat procedures in step 5 to set the desired minutes.
- If you wish to go back to the left, press [◀].

**6** Use [▲ / ▼] to select the recording mode. Refer to page 24 for details.



**7** Press [OK].  
 "To Standby Mode" is highlighted.

**8** Press [OK] again.

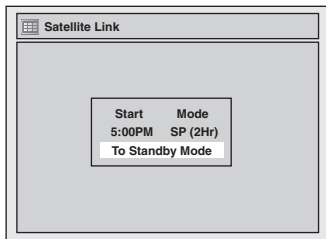

In a second, the unit will be turned off automatically as it goes into the satellite link standby mode.

**To cancel the satellite link function while in the satellite link standby mode:**









Press [STANDBY/ON 

**To cancel the satellite link function while the satellite link recording is in progress:**

Press [■ STOP] on the front panel of the unit.

## Notes

- If the signal of external input breaks up over 5 seconds, satellite link function will be canceled.
- If you have not set the clock, "Clock Setting" menu will appear at step 3. Follow to step 4 in "SETTING THE CLOCK" on page 23.
- You cannot set the end time for the satellite link timer recording on this unit.
- Recording picture will be distorted if the copy protection signal is being detected during satellite link timer recording.
- You can record the satellite link by using S-video input jacks on the rear panel. Refer to page 11 for more information.
- When a regular timer recording and the satellite link timer recording are overlapped, those recordings are recorded as illustrated below.
- Press [TIMER PROG.] during the satellite link timer recording to check the satellite link timer recording in progress.

	example 1	example 2	example 3
timer recording			
satellite link			
actual recording			

The first 2 minutes (at the longest) will be cut off.

The first 2 minutes (at the longest) will be cut off.

# OVERWRITING UNNECESSARY TITLE

## Overwriting from the Beginning of the Title



You can overwrite the existing title from the beginning.

**1) Press [STANDBY/ON ○].**

Make sure that the TV input is set on the unit.

**2) Load the disc that includes a title to be overwritten.**

**It takes a while to display the title list.**

Title list will appear.

If the title list does not appear, press [TITLE].

**3) Press [REC MODE] repeatedly to select a recording mode.**

Refer to "Recording Mode" on page 24.

**4) Use [▲ / ▼] to select a title to be overwritten, then press [OK].**

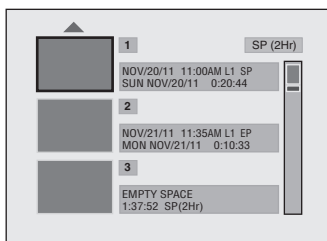

**5) Use [▲ / ▼] to select "Overwrite", then press [OK].**



**6) Press [SOURCE] to select the appropriate external input position (L1/L2) to which your external tuner is connected. Then select the desired channel to record on the external tuner.**

e.g.) DVD+RW

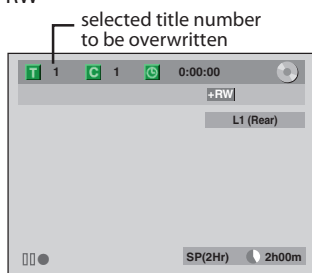

**7) Press [REC].**

Overwriting recording starts.

The elapsed-time counter starts running.

**8) Press [STOP ■] to stop recording.**

Title name is also overwritten.

**This operation may take a while to be completed.**

### Note

- The remaining recording time is displayed on the bottom right corner of the TV screen during overwriting.

## Overwriting in the Middle of the Title



You can overwrite the existing title from the selected position.

**1) Follow the steps 1, 2 and 4 on the left.**

**2) Use [▲ / ▼] to select "Play", then press [OK].**

Playback will start.

**3) Press [PAUSE ||] at the point from which you want to start overwriting.**

**4) Press [REC].**

"||●", display menu, channel, and the time lapse will be displayed as illustrated on the left.

**5) Press [SOURCE] to select the appropriate external input position (L1/L2) to which your external tuner is connected. Then select the desired channel to record on the external tuner.**

**6) Press [REC] again.**

Overwriting recording starts.

**7) Press [STOP ■] to stop recording.**

**This operation may take a while to be completed.**

### Note

- Recording mode of the overwriting title is the same as that of the original (overwritten) title when overwriting in the middle of the title.
- Title name will not be overwritten.

# OVERWRITING UNNECESSARY TITLE

## Hints for Overwriting

When you overwrite on the unnecessary title, there were various circumstances such as follows. Please note that following cases only describe the overwriting without any recording mode discrepancy. To avoid accidental deletion please check if there is no important title after the overwriting point.

### When overwriting title is shorter than the existing title:

(overwriting from the beginning of the title)

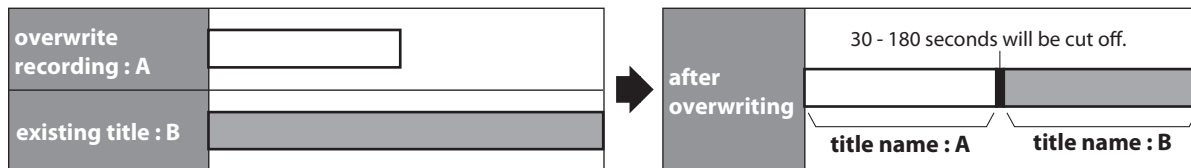

### When overwriting title is longer than the existing title:

(overwriting from the beginning of the title)

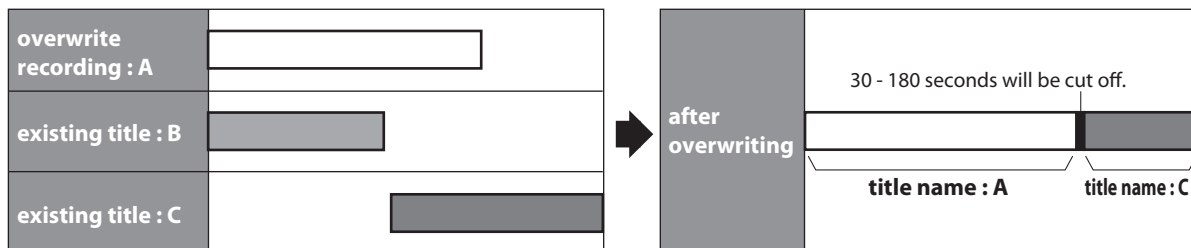
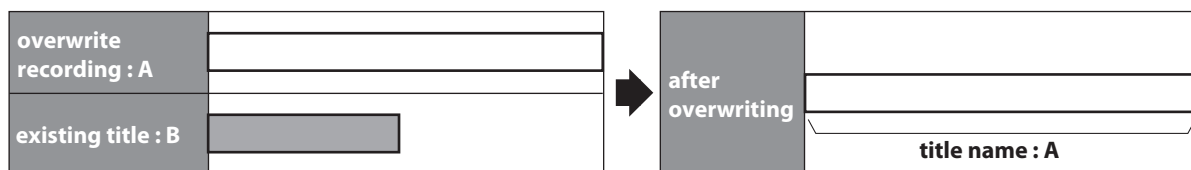

### When overwriting in the middle of the title:

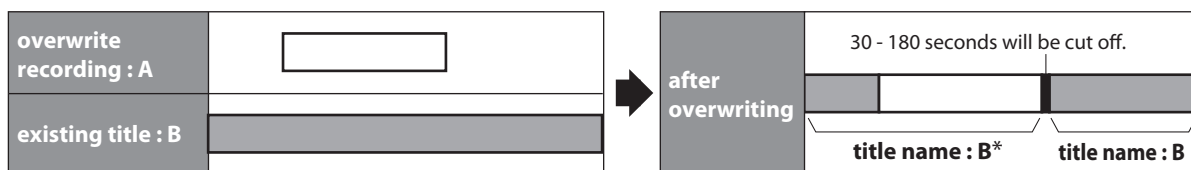

\*Overwritten section and the rest of the sections will have the same title name as the original existing title (B).

### Note

- When a title name is overwritten, its thumbnail is also overwritten.
- "Auto Chapter" interval time is reset at the overwriting start point.
- A chapter mark is put at the beginning of the overwrite title when overwriting in the middle of the title.

# SETTINGS FOR AN EXTERNAL DEVICE

## Connection to an External Device

Connect the external device properly to the unit by using input jacks either L2 (Front) or L1 (Rear). When connecting an external device of monaural output to this unit, use AUDIO L jack of L2 (Front) or L1 (Rear). Use S-video or the RCA audio/video cables for this connection.

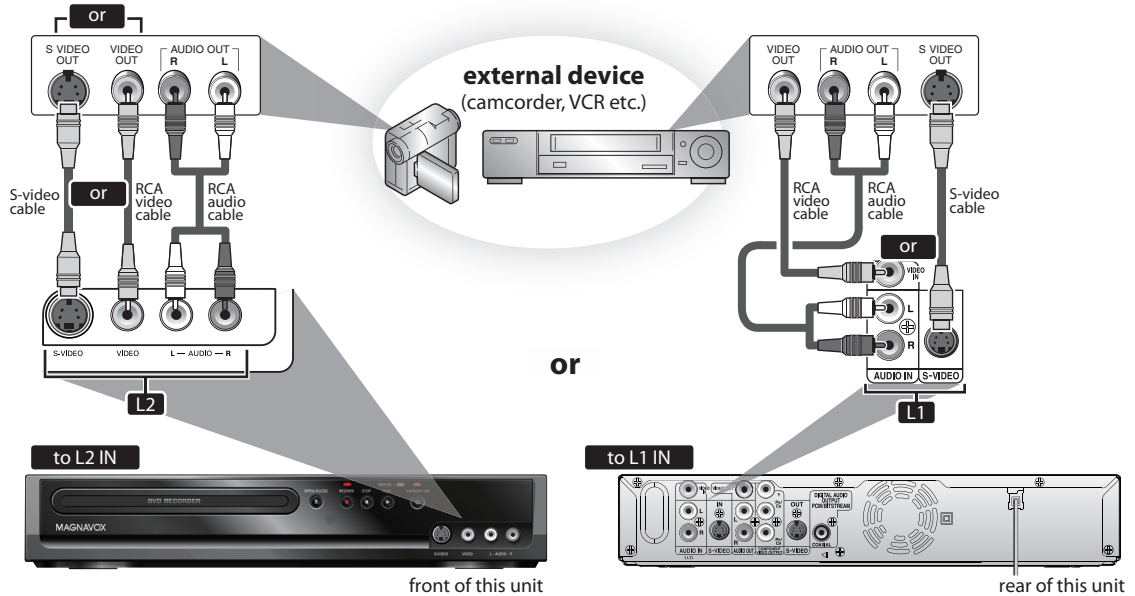

### Supplied cables used in this connection are as follows:

- RCA audio cable (L/R) x 1
  - RCA video cable x 1
- Please purchase the rest of the necessary cables at your local store.

**1** Press [MENU] and use [▲ / ▼] to select "General Setting", then press [OK].

"General Setting" menu will appear.

**2** Use [▲ / ▼] to select "Video", then press [OK].  
Submenu will appear.

**3** Use [▲ / ▼] to select "Video Input", then press [OK].

**4** Use [▲ / ▼] to select desired external input, then press [OK].

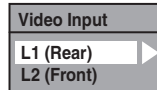

**5** Use [▲ / ▼] to select the input jack type to connect, then press [OK].  
If you want to use VIDEO IN jack, select "Video In".  
If you want to use S-VIDEO IN jack, select "S-Video In".

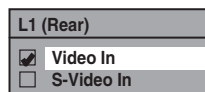



**6** Press [MENU] to exit.

# SETTINGS FOR AN EXTERNAL DEVICE

## Recording from an External Device

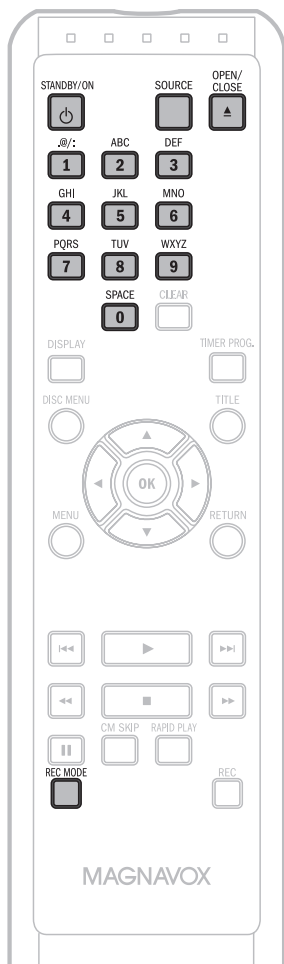
Before recording from an external device, refer to the instructions for the connection on page 36.



**1** Turn on the TV and press [STANDBY/ON , and be sure to select the input of the TV to which the unit is connected.

**2** Press [OPEN/CLOSE ] to open the disc tray. Place the disc to record properly.

**3** Press [OPEN/CLOSE ] to close the disc tray.

It may take a while to load the disc data after the disc tray closes.

**4** Select the appropriate external input channel (L1 or L2) by pressing [SOURCE].

- If the external device is connected to the rear of this unit, select L1.
- If the external device is connected to the front of this unit, select L2.
- You can also select L1 or L2 channel by using [the Number buttons]. e.g.) For L1, press [0], [0], [1].

**5** Press [REC MODE] repeatedly to select a recording mode.

Refer to "Recording Mode" on page 24.

HQ (1Hr) → SP (2Hr) → SPP (2.5Hr) → LP (3Hr) → EP (4Hr) → SLP (6Hr)

**6** Press [●RECORD] on the unit to start recording.

**7** Start playback on the external device to record from.

**8** Press [■STOP] on the unit to stop recording.

This operation may take a while to be completed.

# SETTING A DISC TO PROTECT

To prevent accidental recording, editing or erasing the titles, you can protect them from "Disc Edit" menu.

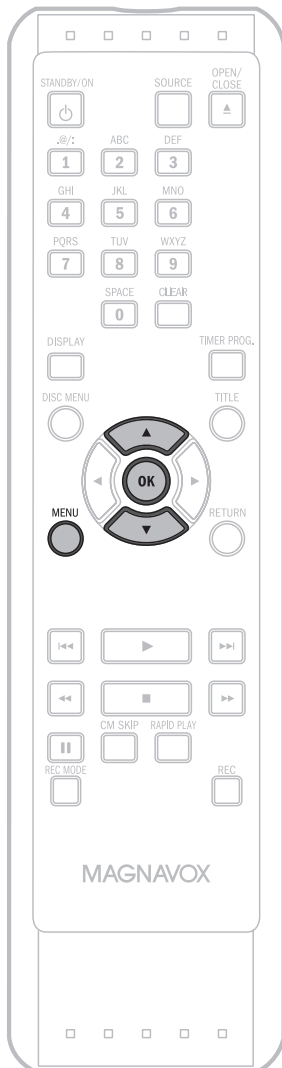

**1** Press [MENU].

**2** Use [▲ / ▼] to select "Disc Edit", then press [OK].

**3** Use [▲ / ▼] to select "Disc Protect OFF → ON", then press [OK].  
e.g.) DVD+RW

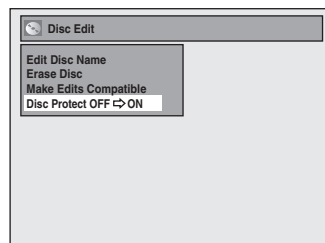

**4** Use [▲ / ▼] to select "Yes", then press [OK].

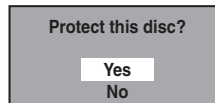

A disc will be protected.

**This operation may take a while to be completed.**

## Note

### To cancel the disc protect:

- When you insert a disc protected with this unit, "Disc Protect ON → OFF" will appear instead of "OFF → ON" at step 3.

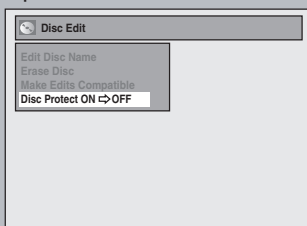

To release the protection for the disc, select "Disc Protect ON → OFF" at step 3, then follow rest of the procedures.

# PLAYING THE DISCS ON OTHER DVD PLAYERS

## Finalizing a Disc



You will need to finalize DVD+R, DVD-RW or DVD-R to play them back on other DVD players.

Finalizing may take several minutes up to an hour.

A shorter recording period on the disc will require a longer time period for finalization. Do not unplug the power cord during finalization.

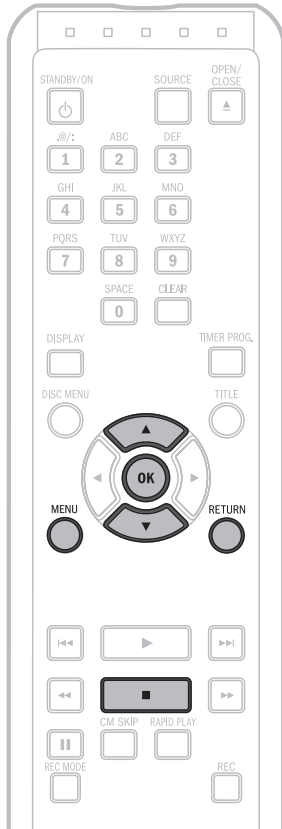

- 1** Press [MENU].
- 2** Use [▲ / ▼] to select "Disc Edit", then press [OK].  
"Disc Edit" menu will appear.
- 3** Use [▲ / ▼] to select "Finalize", then press [OK].
- 4** Use [▲ / ▼] to select "Yes", then press [OK].

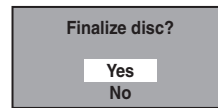



Finalizing will start.

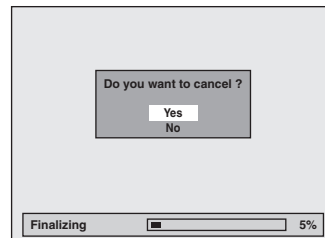

### To cancel finalizing... (DVD-RW only)

- To cancel finalizing at step 4, press [STOP ■], select "Yes" with [▲ / ▼], then press [OK]. Finalizing is canceled and the unit will be in stop mode.



- If  appears when pressing [STOP ■], you cannot cancel finalizing because the finalizing has been in certain progress.
- When selecting "No" and press [OK] or [RETURN], finalizing will be continued.
- You cannot cancel finalizing the DVD+R/DVD-R disc once it has started.

This operation may take a while to be completed.

- 5** Finalizing is completed.

### Note

- Once you start the finalization, no controls are available. You cannot cancel or stop the finalizing mode. Please wait until it finishes the finalization process.
- There is no need to finalize DVD+RW.
- When you insert a DVD-RW finalized with this unit, "Undo Finalize" will appear instead of "Finalize".

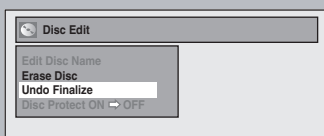

To release the finalizing for the disc, select "Undo Finalize" at step 3.

- \* DO NOT turn the power off or place unit in standby mode during finalization, this will result in a malfunction.

# PLAYING THE DISCS ON OTHER DVD PLAYERS

## Auto Finalizing



You can finalize discs automatically using this function. You can use this function to finalize discs after finishing timer recordings and at the end of the disc space.

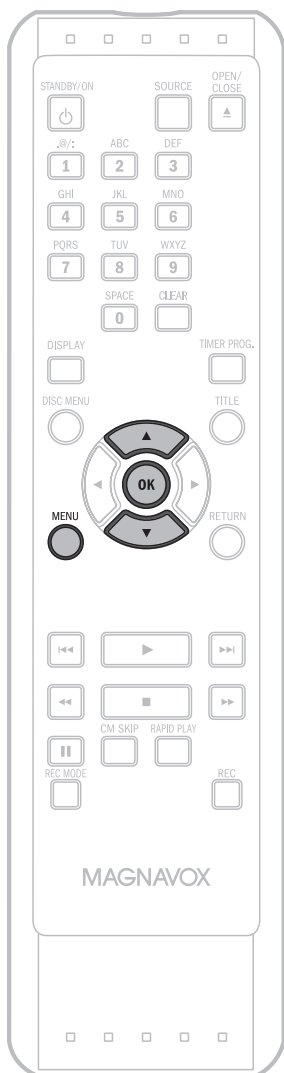

**1** Press [MENU] and use [▲ / ▼] to select **“General Setting”**, then press [OK].

“General Setting” menu will appear.

**2** Use [▲ / ▼] to select **“Recording”**, then press [OK].

“Recording” menu will appear.

**3** Use [▲ / ▼] to select **“Auto Finalize”**, then press [OK].

**4** Use [▲ / ▼] to select **“Disc Full”** or **“End of Timer Rec”**, then press [OK].

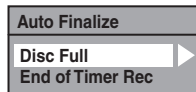

**5** Use [▲ / ▼] to select **“ON”**, then press [OK].

e.g.) “Disc Full”

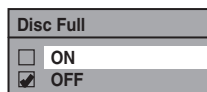

Your setting will be activated.

**6** Press [MENU] to exit.

### Note

- This function is not available after finishing daily or weekly program recording.



# INFORMATION ON PLAYBACK

Before you play back DVD, read the following information.

## Playable Discs and Files

This unit is compatible to play back the following discs. To play back a DVD, make sure that it meets the requirements for region codes and color systems as described below. You can play back discs that have the following logos will play back on the unit. Other disc types are not guaranteed to play back.

Playable discs	Logos
DVD-video	
DVD+RW	
DVD+R	
DVD-RW (Finalized video mode discs only)	
DVD-R (Finalized video mode discs only)	
CD-DA (audio CD)	
video CD	 
CD-RW	 
CD-R	 
Playable discs	Media
MP3	CD-RW/-R

 is a trademark of DVD Format/Logo Licensing Corporation.

## Unplayable Discs

The following discs will not play back on this unit.

- CD-ROM
- DVD-RAM
- DVD-ROM
- Unfinalized disc
- DVD or CD contains Windows Media™ Audio / DivX® files
- DVD-R or DVD-RW recorded in VR mode or non compatible recording format
- Blu-ray Disc
- Super Video CD
- Compact Disc-Interactive (CD-I)
- Video Single Disc (VSD)
- DVD-audio
- HD DVD

On the following disc, the sound may not be heard.

- Super Audio CD - Only the sound on the CD layer can be heard. The sound on the high-density super audio CD layer cannot be heard.

## Color Systems

DVD is recorded in different color systems throughout the world. The most common color system is NTSC (which is used primarily in the United States and Canada). This unit uses NTSC, so DVD you play back must be recorded in the NTSC system. You cannot play back DVD recorded in other color systems.

## Region Codes

This unit has been designed to play back DVD with region 1. DVD must be labeled for ALL regions or for region 1 in order to play back on the unit. You cannot play back DVD that are labeled for other regions. Look for the symbols on the right on your DVD. If these region symbols do not appear on your DVD, you cannot play back the DVD in this unit.

The number inside the globe refers to region of the world.

A DVD labeled for a specific region can only play back on the unit with the same region code.



# INFORMATION ON PLAYBACK

## PBC (playback control) for Video CD

You can select images or information on the menu screen by activating the PBC (playback control) function of the video CD.

This unit conforms to ver.1.1 and ver. 2.0 of video CD standard with PBC function.

Ver.1.1 (without PBC function): You can enjoy playback picture as well as music CD.

Ver.2.0 (with PBC function): While using a video CD with PBC function, "PBC" appears on the TV screen.

- 1) Press [MENU].
- 2) Use [▲ / ▼] to select "DISC Playback Mode", then press [OK].  
"DISC Playback Mode" menu will appear.
- 3) Use [▲ / ▼] to select "PBC (Video CD only)", then press [OK].
- 4) Use [▲ / ▼] to select "ON" or "OFF", then press [OK].  
Your setting will be activated.

You can play back interactive software using menu screens. Refer to instructions in the video CD.

### Note

- PBC setting turns to "ON" when loading video CD with PBC function, thus, even after setting PBC to "OFF" and ejecting the video CD then reloading the video CD, this setting turns to "ON" automatically.
- Some operations cannot be performed while PBC function is on. Cancel PBC function temporarily to perform those operations by following the instruction below.

## Hint for DVD Playback

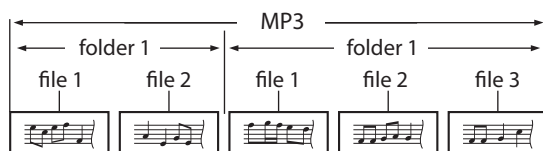
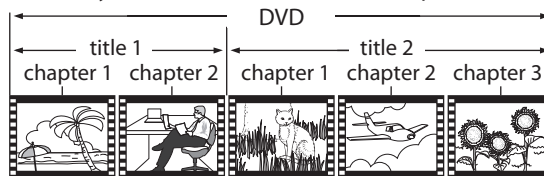

The contents of DVD are generally divided into titles. Titles may be further subdivided into chapters.

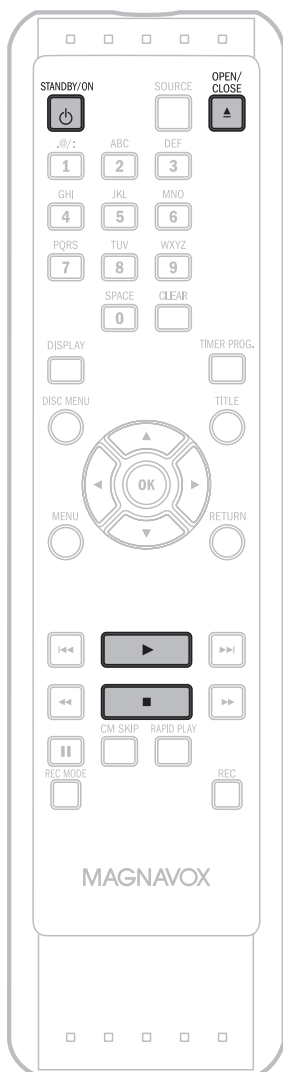

# BASIC PLAYBACK

## Direct Playback



- 1 Press [STANDBY/ON .**  
Turn on the TV and be sure to select the input to which the unit is connected.
- 2 Press [OPEN/CLOSE .** to open the disc tray and insert your disc with its label facing up.

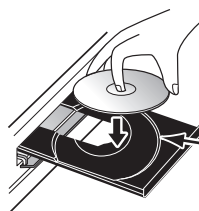



Align the disc to the disc tray guide.

\* Make sure the disc is compatible with this unit.  
(Refer to page 41 for the list of compatible discs.)

- 3 Press [OPEN/CLOSE .** to close the disc tray.

It may take a while to load the disc data after the disc tray closes.

- 4 Press [PLAY .** to start playback.  
If you are playing back a DVD-video or video CD with PBC function, a menu may appear. Refer to "Using the Title / Disc Menu" on page 47.

- 5 Press [STOP .** once to stop playback temporarily.  
• Refer to "Resume Playback" on page 48.

### Note

- Some discs may start playback automatically.
- You can select images or information on the menu screen by activating PBC (playback control) function (page 53).

# BASIC PLAYBACK

## Playback from the Title List

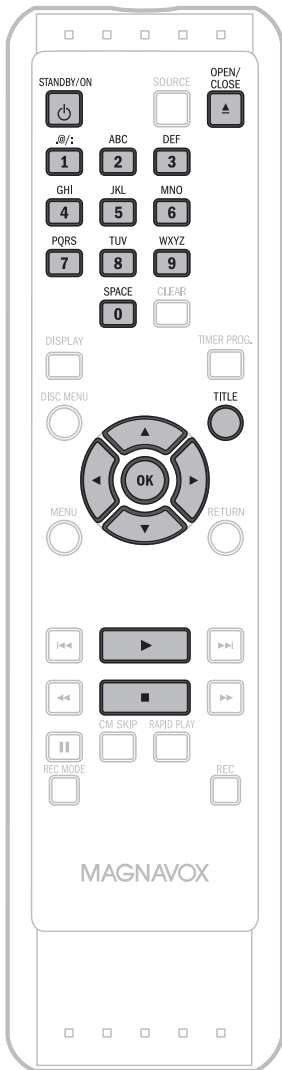

- 1 Press [STANDBY/ON  $\odot$ ].**  
Turn on the TV and be sure to select the input to which the unit is connected.
- 2 Press [OPEN/CLOSE  $\blacktriangle$ ] to open the disc tray and insert your disc with its label facing up.**

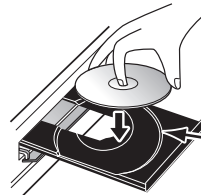

Align the disc to the disc tray guide.

\* Make sure the disc is compatible with this unit.  
(Refer to page 41 for the list of compatible discs.)

- 3 Press [OPEN/CLOSE  $\blacktriangle$ ] to close the disc tray.**

**It may take a while to load the disc data after the disc tray closes.**

- Title list will appear automatically.
- To exit the title list, press [STOP  $\blacksquare$ ].
- To resume the title list, press [TITLE].

- 4 Use [ $\blacktriangle$  /  $\blacktriangledown$ ] to select a desired title, then press [OK].**

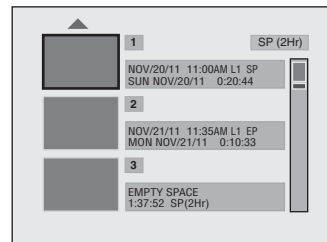

- For video CD, when "PBC (Video CD only)" in "DISC playback Mode" menu is set to "ON", the video CD main menu will appear when inserting a disc. In such case, select a numbered menu with [the Number buttons].
- Press [▶] to display the next page, and press [◀] to display the previous page.

If you want to see disc information, press [◀] when the first page of the title list is displayed or press [▲] when the first title is selected but not when "Play", "Edit" or "Overwrite" is highlighted.

e.g.) DVD+RW

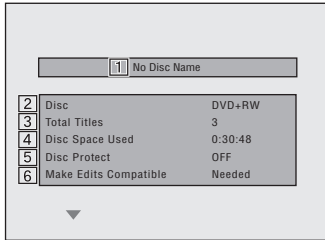

e.g.) DVD+R

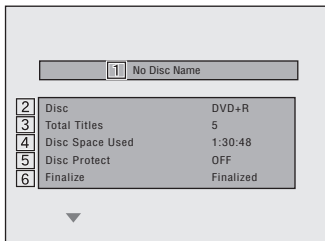

1. Disc name (Default "No Disc Name")
2. Disc type (DVD+RW/DVD+R/ DVD-RW/DVD-R)
3. Total number of title (include "EMPTY SPACE")
4. Total time of recorded disc space
5. Status of disc protection ("ON" is protected disc.)
6. Making edits compatible/finalize
  - When DVD+RW is inserted:  
If the disc needs to be set "Make Edits Compatible", "Needed" is displayed. Otherwise, "Not Needed" is displayed. (Refer to page 67.)
  - When DVD+R, DVD-RW or DVD-R is inserted:  
If "Finalize" is done, "Finalized" is displayed. Otherwise, "Unfinalized" is displayed.

## 5 Use [▲ / ▼] to select "Play", then press [OK].



Playback will start.

## 6 Press [STOP ■] once to stop playback temporarily.

- Refer to "Resume Playback" on page 48.

### Note

- Some discs may start playback automatically.
- You can also start playback by pressing [PLAY ►] instead of [OK] at step 4.

# BASIC PLAYBACK

## Playing Back an Audio CD and a CD-RW / -R with MP3 Files

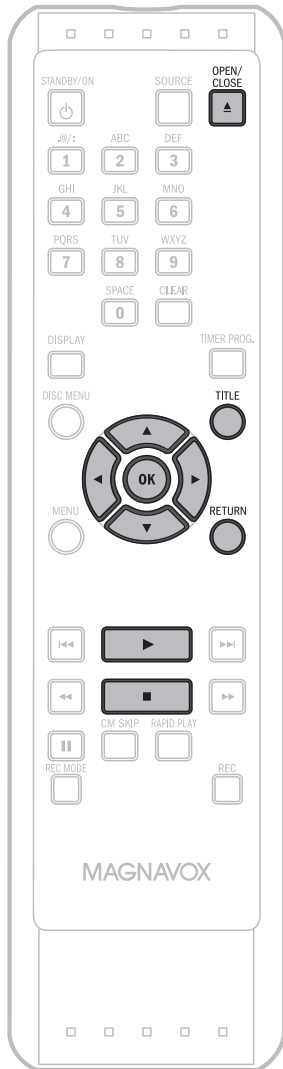

**1** Follow steps 1 to 2 in “Direct Playback” on page 43.

**2** Press [OPEN/CLOSE ▲] to close the disc tray.

It may take a while to load the disc data after the disc tray closes.

When an audio CD is inserted, track list will appear. When a CD-RW/-R with MP3 files is inserted, file list will appear.

- To exit the track/file list, press [STOP ■].
- To resume the track/file list, press [TITLE].

**3** Use [▲ / ▼] to select a desired folder or track/file, then press [OK].  
e.g.) File list

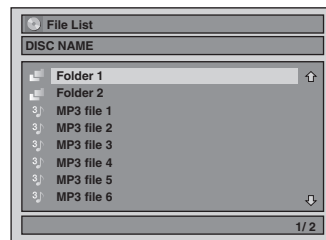

**When selecting track/file:**

Playback will start.



**When selecting the folder (Not available for audio CD):**

The files in the folder will appear.

Use [▲ / ▼] to select the file or folder you want to play back, then press [OK].

- Press [PLAY ►], [OK] or [▶] to move to any lower hierarchies.
- Press [◀] or [RETURN] to move back to the previous hierarchy.

**Hints for audio CD tracks and MP3 files:**

- Folders are shown by .
- Audio CD tracks are shown by .
- MP3 files are shown by .
- The system can recognize up to 255 folders, up to 99 tracks/999 files.
- Letters of a file/folder name overflowing the given space will be displayed as “...”. Unrecognizable characters will be replaced with asterisks.
- If there are no files in the folder, “No Files” will be displayed.

**It is recommended that files to be played back in this unit are recorded under the following specifications:**

<MP3>

- Sampling frequency : 44.1 kHz or 48 kHz.
- Constant bit rate : 112 kbps - 320 kbps

### Note

- The audio source of MP3 files cannot be recorded as digital sound by an MD or DAT deck.
- Files whose extension is other than “.mp3(MP3)” will not be listed.
- Some unplayable folders or files may be listed due to the recording status.

## Using the Title / Disc Menu



DVD or video CD with PBC function may contain a title list, which describes the contents of the disc, or a disc menu, which guides you through the available functions in the disc.

- 1) Press [TITLE] or [DISC MENU] to call up the title list or disc menu.
- 2) Use [▲ / ▼ / ◀ / ▶] to make a selection, and then press [OK] to enable your selection.
- 3) Press [STOP ■] to exit.

### Note

- You can select a numbered menu with [the Number buttons] also.
- Menus vary among discs. Refer to the information accompanying the disc for details.
- [TITLE] or [DISC MENU] will not always be active with all DVD.
- For video CD, when "PBC (Video CD only)" in "DISC Playback Mode" menu is "ON", the video CD main menu will appear when inserting a disc.

## Pause

- 1) During playback, press [PAUSE II].  
Playback will be paused and sound will be muted.

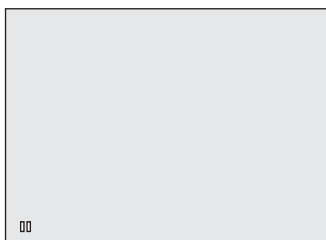

- 2) Press [PLAY ►] to return to the normal playback.

### Note

- On DVD, set "Still Mode" to "Field" in "Playback" menu if pictures in the pause mode are blurred. (Refer to page 72.)

# SPECIAL PLAYBACK

## Resume Playback

You can play back from where you stopped playing back the disc last.

### 1) During playback, press [STOP ■].

The resume message will appear.

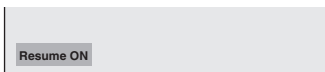

### 2) Press [PLAY ►].

In a few seconds, playback will resume from the point at which it stopped last. You can resume playback at the same point even if you turn the unit to the standby mode.

To cancel the resume playback and start playing back the disc from the beginning, press [STOP ■] again while the playback is stopped.

### Note

- For MP3 files, playback will resume from the beginning of the file at which playback was stopped.
- Resume Playback is available when you play back the video CD without PBC function.
- Some video CD with the PBC function resume playback from the beginning of the track.

## Fast Forward / Fast Reverse Playback



### 1) During playback, press [▶▶] or [◀◀].

Every time you press [▶▶] or [◀◀], approximate speed will be changed as follows.

Fast forward or fast reverse playback across titles (for DVD) or files (for MP3 files) is not possible.



For video CD, approximate forward/reverse speeds are 2x, 8x, 16x.

For audio CD, MP3 files, approximate speed is fixed at 8x with sound (indicated with ▶▶▶▶ / ▶▶▶▶).

### 2) Press [PLAY ►] to return to the normal playback.

### Note

- Forward/reverse speed will be indicated with icons as follows.  
forward (approx. speed)  
2x: ▶▶  
20x: ▶▶▶  
40x: ▶▶▶▶  
reverse (approx. speed)  
5x: ▶▶  
20x: ▶▶▶  
40x: ▶▶▶▶

## Skipping TV Commercials During Playback



You can skip TV commercials to enjoy the recorded programs without interrupting.

### During playback, press [CM SKIP].

Normal playback will start at 30 seconds ahead from the point you press [CM SKIP].

Every time you press [CM SKIP], the searching point will be extended by 30 seconds ahead.

You can press [CM SKIP] up to 6 times (180 seconds).

e.g.) Press [CM SKIP] once.

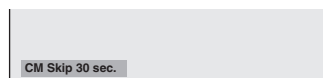

(forwarding 30 seconds)

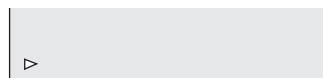

Playback will return to the normal playback.

## Rapid Playback



Rapid playback function is available only during playback.

This function is available only on discs recorded in the Dolby Digital format, and plays back in a slightly faster/slower speed while keeping the sound quality just as normal playback.

### 1) During playback, press [RAPID PLAY].

- ▶ **x0.8:** Press [RAPID PLAY] once during playback. Plays back approximately at 0.8 times of normal playback.
- ▶ **x1.3:** Press [RAPID PLAY] twice during playback. Plays back approximately at 1.3 times of normal playback.
- ▶: Press [RAPID PLAY] 3 times to play back in normal speed. No effects.

### 2) Press [PLAY ►] to return to the normal playback.

### Note

- Audio (language) setting cannot be changed while using this mode.
- This feature may not work at some point in a disc.
- Audio is PCM during rapid playback mode except when using digital audio connection.
- When using digital audio connection (COAXIAL), the LPCM sound (2 channel) will be output.



## Step by Step Playback



### 1) During playback, press [PAUSE II].

Playback will be paused and sound will be muted.

### 2) Press [▶▶] repeatedly.

Playback will advance one frame (or step) at a time when you press [▶▶] with the sound muted.

To play back step by step backward:

Press [◀◀] repeatedly.

Every time you press the button, the playback will go backward by one frame.

- Press and hold [◀◀] / [▶▶] to reverse/ advance continuously.

### 3) Press [▶] to return to the normal playback.

#### Note

- Only step by step forward playback is available for playing back video CD.

## Slow Forward / Slow Reverse Playback



### 1) During playback, press [PAUSE II]. Then press [▶▶] or [◀◀].

Every time you press [▶▶] or [◀◀], approximate speed will be changed as follows. (The sound will remain muted.)



### 2) Press [▶] to return to the normal playback.

#### Note

- Forward/reverse speed will be indicated with icons as follows.

forward (approx. speed)

1/16x: ▶▶▶▶

1/8x: ▶▶▶▶▶

1/3x: ▶▶▶▶▶▶

reverse (approx. speed)

1/16x: ◀◀◀◀

1/8x: ◀◀◀◀◀

1/4x: ◀◀◀◀◀◀

- Only slow forward is available when playing back video CD.

## Zoom



### 1) During playback, press [DISPLAY] to bring up the display menu.

### 2) Use [◀ / ▶] to select [⊕] to display the selection menu.

e.g.) DVD-video

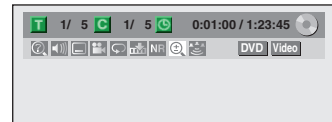

### 3) Use [▲ / ▼] to select a desired zoom factor to zoom, then press [OK].

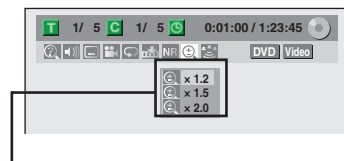

Zoom menu will appear.

There are four options

(x1.0, x1.2, x1.5 and x2.0), these are displayed excluding the current zoom rate.

Zoom area will be displayed.

### 4) Use [▲ / ▼ / ◀ / ▶] to select a desired zoom position, then press [OK].

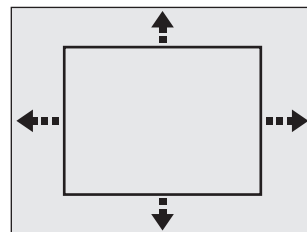

Zoom playback will start.

#### Note

- When selecting a smaller factor than the current one, the zoom area will not be displayed.
- To exit the zoom menu, press [RETURN] repeatedly at step 3.
- To cancel the zoom function, select "x1.0" using [▲ / ▼], then press [OK].
- When you zoom a picture during a slide show, the slide show will be put in the pause mode. Press [▶] to resume the slide show and the zoom function will be turned off.

## Marker Setting



This feature allows you to assign a specific point on a disc to be called back later.

### 1) During playback, press [DISPLAY] to bring up the display menu.

If the display menu is already shown, skip to step 2.

### 2) Use [◀/▶] to select to display the marker list.

e.g.) DVD-video

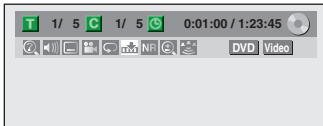

### 3) Use [▲ / ▼] to select a desired marker number. When it reaches the desired point, press [OK].

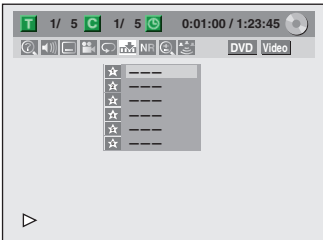

The title (track) number and the time will be displayed.

### 4) To return to the marker later:

Use [▲ / ▼] to select the desired marker number, then press [OK].

#### Note

- To clear a marker, select the marker number to be cleared, then press [CLEAR].
- All markers will be erased when you operate these operations listed below.
  - Opening the disc tray
  - Turning the unit to standby / off
  - Record on a recordable disc
- You can mark up to 6 points.
- Marker setting is not available when you play back the video CD with PBC function.

## Repeat Playback

Available repeat function may vary depending the discs.

### 1) During playback press [DISPLAY] to bring up the display menu, then proceed to step 2), or press [REPEAT] then proceed to step 3).

If the display menu is already shown, skip to step 2.

### 2) Use [◀/▶] to select to display the selection menu.

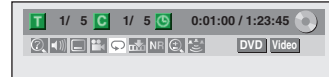

### 3) Use [▲ / ▼] to select a desired repeat type, then press [OK].

The selected repeat playback will start.

e.g.) DVD-video

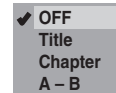

e.g.) audio CD, video CD



e.g.) MP3 files

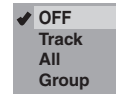

#### Title:

The current title will be played back repeatedly.

#### Chapter:

The current chapter will be played back repeatedly.

#### All:

The current disc will be played back repeatedly.

#### A-B:

Desired section can be played back repeatedly.

1) Use [▲ / ▼] to select "A-B", then press [OK].

2) Press [OK] at the desired starting point A.

3) Press [OK] at the desired ending point B.

#### Track:

The current track or file will be played back repeatedly.

#### Group:

The current folder will be played back repeatedly.

#### Note

- Point B for the repeat A-B playback should be set within the same title or track as point A.
- To cancel the repeat playback, select "OFF" at step 3. The repeat setting will also be canceled when you stop playback.
- You cannot select "Group" during the random playback.
- Repeat playback is not available when you play back the video CD with PBC function.
- During the A-B repeat, if you reaches the point A with any reverse playback, the reverse playback will be canceled and the A-B repeat playback resumes from point A.

## Random Playback



You can play back a disc randomly instead of playing back in the original order.

- 1) Press [MENU].
- 2) Use [▲ / ▼] to select "DISC Playback Mode", then press [OK].  
"DISC Playback Mode" menu will appear.  
For MP3, use [▲ / ▼] to select "Music", then press [OK].
- 3) Use [▲ / ▼] to select "Random Play", then press [OK].  
Random playback will start.

### Note

- To cancel random playback, press [STOP ■] twice during random playback. "OFF" appears on the TV screen.
- For video CD with PBC function, the PBC setting will be switched to off automatically when you start random playback.

## Program Playback



You can program the disc to play back in your desired order.

- 1) Press [MENU].
- 2) Use [▲ / ▼] to select "DISC Playback Mode", then press [OK].  
"DISC Playback Mode" menu will appear.
- 3) Use [▲ / ▼] to select "Program Play", then press [OK].
- 4) Use [▲ / ▼] to select a desired track, then press [OK] or [▶].

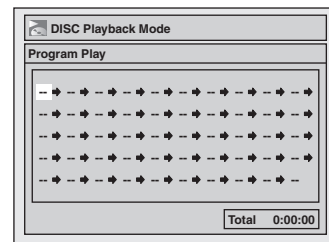

Repeat this step until you program all the desired tracks.

- 5) Press [PLAY ▶].

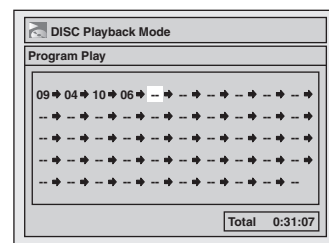

Program playback will start.

### Note

- To erase tracks you selected, press [CLEAR] at step 4.
- You can make program settings up to 50 tracks.
- To cancel program playback, press [STOP ■] twice during program playback. "OFF" appears on the TV screen.
- You may also select a desired track using [the Number buttons] at step 4.
- For video CD with PBC function, the PBC setting will be switched to off automatically when you start program playback.

# SEARCH

## Title / Chapter Search



### Using [◀◀] / [▶▶]

- 1) During playback, press [▶▶] to skip the current title or chapter and move to the next.

The title or chapter will move forward by one at a time.

- If there is no chapter in one title, the current title will be skipped.

To go back to the beginning of the current title or chapter, press [◀◀].

Press it repeatedly to go to the previous title or chapter. The title or chapter will move backward one at a time.

### Using [DISPLAY]

- 1) During playback, press [DISPLAY] to bring up the display menu.

- 2) Use [◀/▶] to select , then press [OK].

e.g.) DVD-video

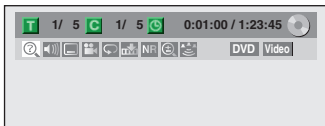

The number next to  will be highlighted.

- 3) Title:

Use [▲ / ▼] or [the Number buttons] to enter a desired title number to search, then press [OK].

Title search will start.

**Chapter:**

Press [▶] to move to the number next to  for chapter.

Use [▲ / ▼] or [the Number buttons] to enter a desired chapter number to search, then press [OK].

After the search, playback will start automatically.

### Note

- In search mode display, total numbers of each search contents (title/chapter/time) are shown as a denominator.

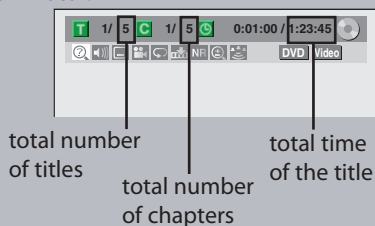

## Track Search



### Using [◀◀] / [▶▶]

- 1) During playback, press [▶▶] to skip the current track/file and move to the next.

The track/file will move forward one at a time.

To go back to the beginning of the current track/file, press [◀◀].

Press it repeatedly to go to the previous track/file. The track/file will move backward one at a time.

### Using [DISPLAY]

- 1) During playback, press [DISPLAY] to bring up the display menu.

- If the display menu is already shown, skip to step 2.

- 2) Use [◀/▶] to select , then press [OK].

e.g.) audio CD

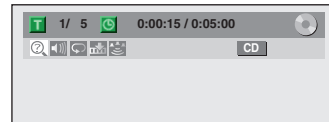

e.g.) MP3 files

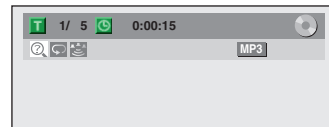

The number next to  will be highlighted.

- 3) Use [▲ / ▼] or [the Number buttons] to enter a desired track/file number to search, then press [OK].

After the search, playback will start automatically.

### Note

- During CD playback you can enter a track number directly using [the Number buttons] for track search without displaying the menu.
- Track search using [DISPLAY] is not available when you play back the video CD with PBC function.

## Time Search



**1) During playback, press [DISPLAY] to bring up the display menu.**

If the display menu is already shown, skip to step 2.

**2) Use [◀/▶] to select , then press [OK].**

e.g.) DVD-video

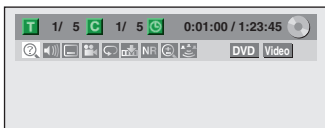

e.g.) audio CD

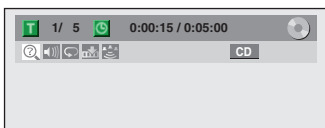

The number next to will be highlighted.

**To move to the number next to , press [▶].**

When time search is not available, and time counter are not displayed.

**3) Use [▲ / ▼ / ▶ / ◀] or [the Number buttons] to enter a desired time to search, then press [OK].**

After the search, playback will start automatically.

### Note

- Time search is available only in the same track, file or title.
- Time search is not available when you play back the video CD with PBC function.

# SELECTING THE FORMAT OF AUDIO AND VIDEO

You can select the format of audio and video as you prefer depending on the contents of the disc you are playing back.

## Switching Subtitles



DVD-video may have subtitles in 1 or more languages. Available subtitle languages can be found on the disc case. You can switch subtitle languages anytime during playback.

1) During playback, press [DISPLAY] to bring up the display menu.

2) Use [◀/▶] to select  to display the selection menu.

e.g.) DVD-video

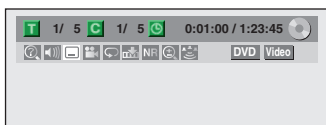

3) Use [▲ / ▼] to select a desired subtitle language, then press [OK].

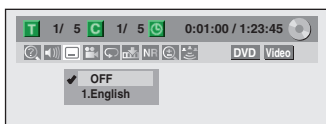

Subtitle will be displayed in the selected language. When selecting "OFF", subtitle will disappear.

### Note

- Some discs will only allow you to change the subtitle from the disc menu. Press [TITLE] or [DISC MENU] to display the disc menu.
- If a 4-digit language code appears in the subtitle menu, refer to "LANGUAGE CODE" on page 80.

## Switching Audio Soundtrack



When playing back a DVD-video recorded with 2 or more soundtracks (these are often in different languages), you can switch them during playback.

When playing back video CD, audio CD you can switch "L/R"(stereo), "L"(left) or "R"(right).

1) During playback press [DISPLAY] to bring up the display menu.

- If the display menu is already shown, skip to step 2.

2) Use [◀/▶] to select  to display the selection menu.

3) Use [▲ / ▼] to select a desired audio soundtrack or audio channel, then press [OK].

For DVD-video

- Audio soundtrack will switch.

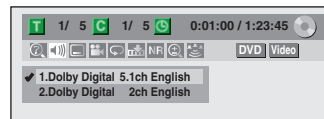

- If the title contains both main and sub audio, you can further select "L" (main), "R" (sub), or "L/R" (mixed of main and sub).

For audio CD, video CD

- Audio channel will switch.

e.g.) audio CD

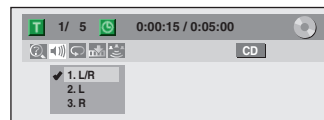

### Note

- Some discs will only allow you to change the soundtrack from the disc menu. Press [TITLE] or [DISC MENU] to display the disc menu.

# SELECTING THE FORMAT OF AUDIO AND VIDEO

## Switching Virtual Surround System



You can enjoy stereophonic virtual space through your existing 2 channel stereo system.

1) During playback, press [DISPLAY] to bring up the display menu.

If the display menu is already shown, skip to step 2.

2) Use [◀/▶] to select  to display the selection menu.

e.g.) DVD-video

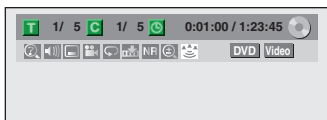

3) Use [▲/▼] to select "OFF", "Type 1" or "Type 2", then press [OK].

e.g.) DVD-video

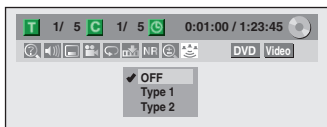

**OFF** : no effect

**Type 1** : natural effect

**Type 2** : emphasized effect

### Note

- Select "OFF" in a case sound is distorted.
- The setting will be kept even when the unit is turned off.

## Switching Camera Angles



Some DVD-video have scenes shot from 2 or more angles. Angle information should be on the disc case if the disc contains multi-angle scenes.

1) During playback, press [DISPLAY] to bring up the display menu.

2) Use [◀/▶] to select , then press [OK].

e.g.) DVD-video

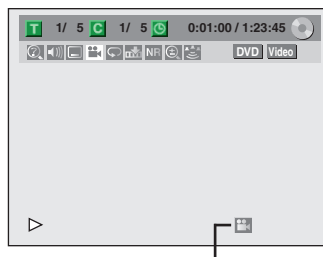

Angle icon appears when a switching camera angle is available.

Angle will switch each time you press [OK].

### Note

- Angle icon does not appear on the TV screen in a case you set "Angle Icon" to "OFF" in "Playback" menu. Refer to page 72.

## Reducing Block Noise



This function reduces noise in the playback picture.

1) During playback, press [DISPLAY] to bring up the display menu.

2) Use [◀/▶] to select  to display the selection menu.

e.g.) DVD-video

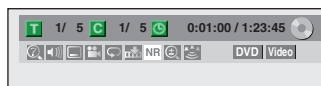

3) Use [▲/▼] to select a desired option, then press [OK].

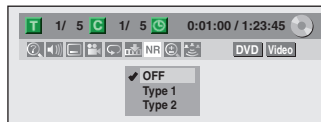

Your setting will be activated.

**OFF** : When playing back titles with a few noises such as DVD-video.

**Type 1** : For the titles recorded in long time mode such as EP or SLP mode.

**Type 2** : Same as type 1, only more effective.

## Guide to a Title List

Title list allows you to check the titles recorded on the disc easily. You can choose a title to play back from this list and easily edit the titles as you prefer.

Press [TITLE].

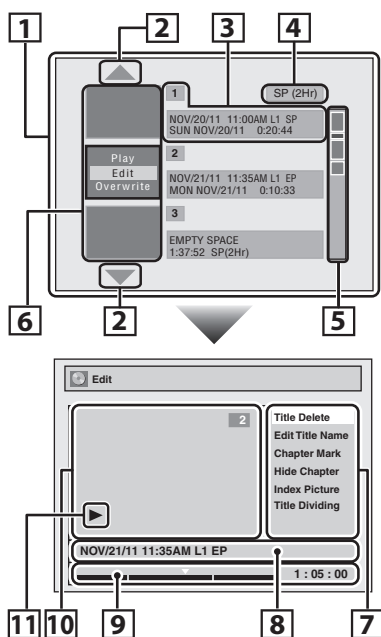

1. **Title list:** List of the titles recorded on the disc, and their information.
2. **Arrow:** Indicating there is a previous / next page.
3. **Title information:** On the first line, title name (editable) is displayed. On the second line, the date recorded and length of the title are displayed.  
**EMPTY SPACE:** The portion of the disc where there are no recordings made. As for the EMPTY SPACE, available recording time by the selected recording mode is displayed on the second line.
4. **Recording mode:** Currently selected recording mode is displayed here.
5. **Capacity indicator:** Indicating the position and the amount of each title in the disc. The portion for the selected title is highlighted.
6. **Thumbnails:** A cut from the recorded content is displayed here.
7. **Submenu:** Submenus for the selected menu are displayed here.
8. **Title name (editable):** If you do not name the title, the recorded date, time, selected external input position, and the recording mode are displayed here.
9. **Progress bar:** Indicating the progress of the playback.
10. **Preview window:** Preview of the selected title is displayed here.
11. **Playback status:** Indicating the current playback status of the selected title.

Press [STOP ■] to exit the title list.

## Editing Discs

You can edit discs for the following items. Be sure that once you edit titles, they will not remain as original.

- Deleting a Title (Refer to page 57.)
- Putting Names on Titles (Refer to page 58.)
- Setting Chapter Marks (Refer to page 59.)
- Clearing Chapter Marks (Refer to pages 60-61.)
- Hiding Chapters (Refer to page 62.)
- Setting Pictures for Thumbnails (Refer to page 63.)
- Dividing a Title (DVD+RW/DVD-RW only) (Refer to page 64.)
- Putting Name on Disc (Refer to page 65.)
- Erasing Disc (Refer to page 66.)
- Making Edits Compatible (Refer to page 67.)

### Note

- When selecting "Edit" on pop-up menu of the title list and edit the title, the title list is displayed after writing the edited contents onto the disc.
- The capacity indicator in the right side of the title list may not indicate the precise capacity in the disc.
- The capacity indicator may not indicate the capacity for the titles of which recording time is short.
- Once you have finalized a DVD+R/ DVD-R, you cannot edit or record anything on that disc.



## Deleting a Title

You can delete a title which you do not need anymore. Please be advised that the titles once deleted cannot be brought back to the disc.

For DVD+RW/DVD-RW, when the last recorded title in the title list is deleted, the available disc space to record on will be increased. For DVD+R/DVD-R, the disc space to record on will not be changed.

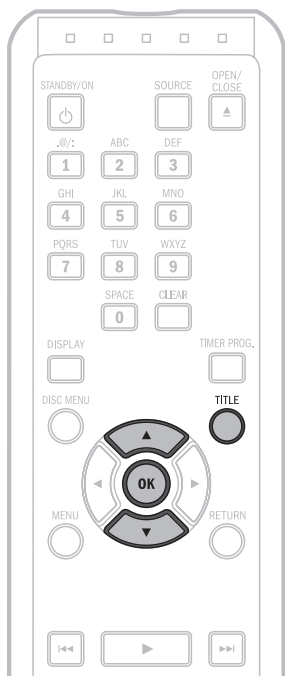

**1** Press [TITLE].

**2** Use [▲ / ▼] to select a desired title, then press [OK].

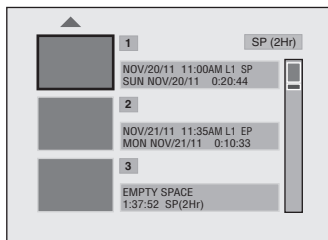

### Note

- Deleted part of the titles in the capacity indicator changes in color.
- As for DVD+RW/DVD-RW if you delete the title, deleted title will be displayed as "EMPTY SPACE".

**3** Use [▲ / ▼] to select "Edit", then press [OK].



**4** Use [▲ / ▼] to select "Title Delete", then press [OK].

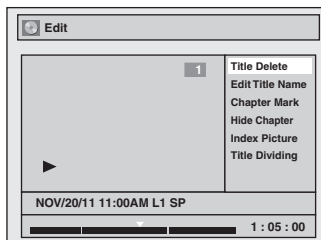

Confirmation message will appear.

**5** Use [▲ / ▼] to select "Yes", then press [OK].

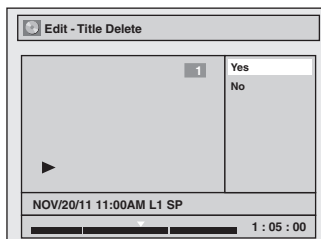

Title will be deleted.

Data will be written onto the disc momentarily. e.g.) DVD+R/DVD-RW/-R

Please finalize the disc when the writing is completed before playing back on other DVD players.

Writing to Disc ██████████ 90%

**This operation may take a while to be completed.**

After editing is complete, the title list will appear. e.g.) DVD+RW/DVD-RW

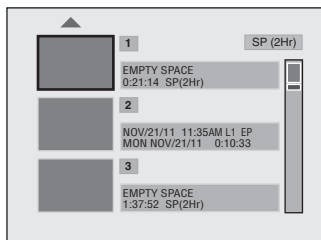

## Putting Names on Titles

You can put title names on the titles and change the names from this menu.

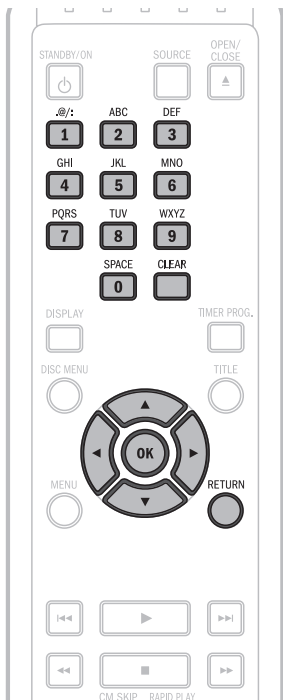

**1** Follow steps 1 to 3 in “Deleting a Title” on page 57 to display “Edit” menu.

**2** Use [▲ / ▼] to select “Edit Title Name”, then press [OK].

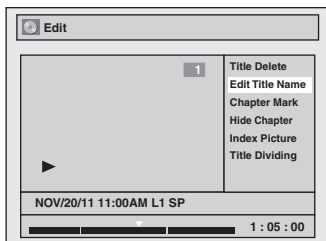

**3** To enter a title name, follow the steps of “Guide to Edit Title Name” on this page.

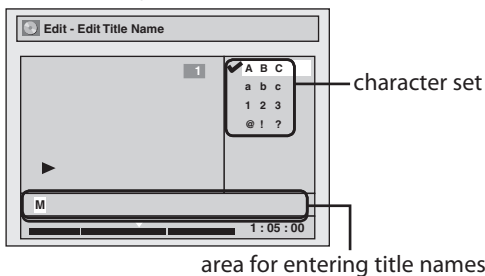

**4** Use [▲ / ▼] to select “Yes”, then press [OK].

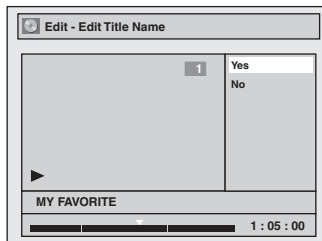

The name you entered will be activated for the title.

**5** After this operation is completed, press [RETURN] to exit. Data will be written onto the disc momentarily.

This operation may take a while to be completed.

### Guide to Edit Title Name

- Use [▲ / ▼] to select a desired character set, then press [OK].
- Follow the list below, use [the Number buttons] repeatedly until the desired letter appears. When you finish entering a title name, press [OK].

Select Press	ABC	abc	123	@ ! ?
0	<space>	<space>	0	<space>
1	(*1)	(*1)	1	! " # \$ % & ' ( ) * + , - . / : ; < = > ? @ [ ] ^ _ {   }
2	ABC	abc	2	
3	DEF	def	3	
4	GHI	ghi	4	
5	JKL	jkl	5	
6	MNO	mno	6	
7	PQRS	pqrs	7	
8	TUV	tuv	8	
9	WXYZ	wxyz	9	

\*1 Press [1], character set will be changed to “@ ! ?” mode automatically. Press [2] to [9] to go back to the previous character set.

- To delete letters, press [CLEAR] repeatedly. Holding [CLEAR] to delete all letters.
- Use [◀ / ▶] to move the cursor to the left and right.
- You can enter up to 30 letters.

### Note

- Undefined letters in a title name are shown by “\*?”. If you delete them, adjoining letters may change to “\*?” or other character.

## Setting Chapter Marks

You can put chapter marks in each title. Once a chapter is marked, you can use it for the chapter search feature.



**1** Follow steps 1 to 3 in “Deleting a Title” on page 57 to display “Edit” menu.

**2** Use [▲ / ▼] to select “Chapter Mark”, then press [OK].  
Submenu will appear.

**3** Press [PLAY ►] and then [PAUSE ■■] to decide the point at which you will create a new chapter mark.  
• It is convenient to use [◀◀], [▶▶], [◀] and [▶] for finding the point to add a new chapter mark.

**4** Use [▲ / ▼] to select “Add”, then press [OK].

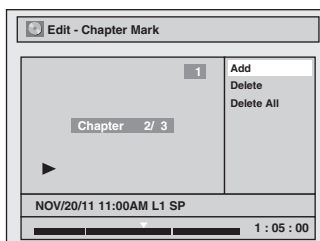

**5** Use [▲ / ▼] to select “Yes”, then press [OK].

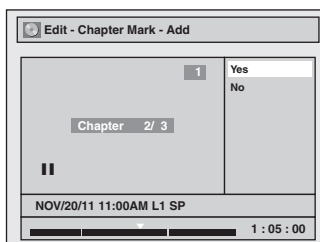

A new chapter mark will be added.

**6** Press [RETURN] twice to exit.  
Data will be written onto the disc momentarily.

**This operation may take a while to be completed.**

### Note

- When the number of chapter marks in a title is 99 and the number of chapter marks in a disc is 254, chapter marks cannot be added.
- Besides the above-mentioned, it is not likely to be able to add according to recorded time and number of chapters.
- Remaining time of the disc may decrease when adding chapter marks or increase when clearing chapter marks depending on the recording time or edited contents.

## Clearing Chapter Marks

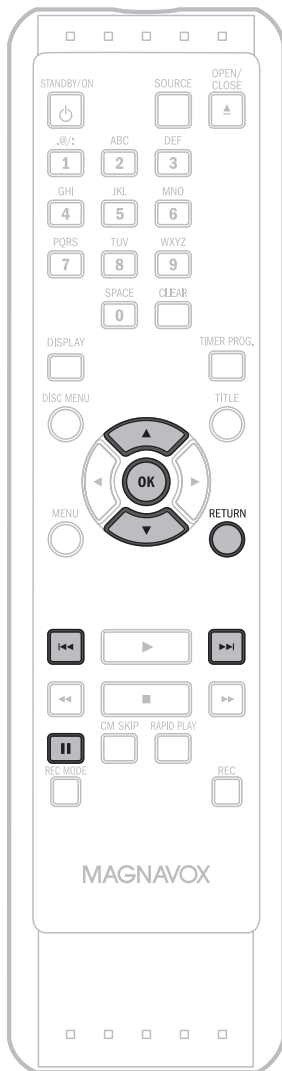

- 1** Follow steps 1 to 3 in “Deleting a Title” on page 57 to display “Edit” menu.
- 2** Use [▲ / ▼] to select “Chapter Mark”, then press [OK].  
Submenu will appear.
- 3** Use [◀◀] / [▶▶] to select a chapter mark to be deleted, then press [PAUSE II].  
Chapter number is displayed on the preview screen.

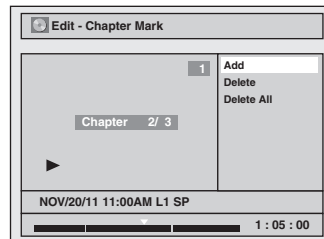

- 4** Use [▲ / ▼] to select “Delete”, then press [OK].
- 5** Use [▲ / ▼] to select “Yes”, then press [OK].

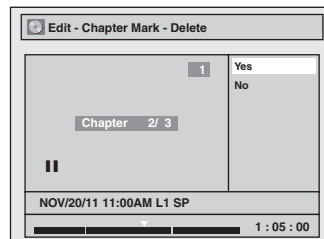

The selected chapter mark will be deleted.

- 6** Press [RETURN] twice to exit.  
Data will be written onto the disc momentarily.
- This operation may take a while to be completed.**

### Note

- Remaining time of the disc may decrease when adding chapter marks or increase when clearing chapter marks depending on the recording time or edited contents.
- You cannot delete the chapter mark 1.

## To delete all chapter marks

**1** Follow steps 1 to 3 in “Deleting a Title” on page 57 to display “Edit” menu.

**2** Use [▲ / ▼] to select “Chapter Mark”, then press [OK].  
Submenu will appear.

**3** Use [▲ / ▼] to select “Delete All”, then press [OK].

**4** Use [▲ / ▼] to select “Yes”, then press [OK].

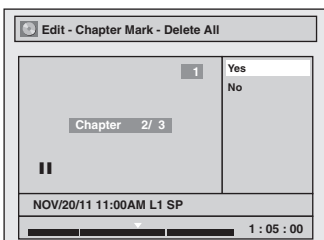

All chapter marks will be deleted.

**5** Press [RETURN] twice to exit.  
Data will be written onto the disc momentarily.

**This operation may take a while to be completed.**

### Note

- Remaining time of the disc may decrease when adding chapter marks or increase when clearing chapter marks depending on the recording time or edited contents.

## Hiding Chapters

You can hide chapters from the title list.  
Hidden chapters are skipped during playback.

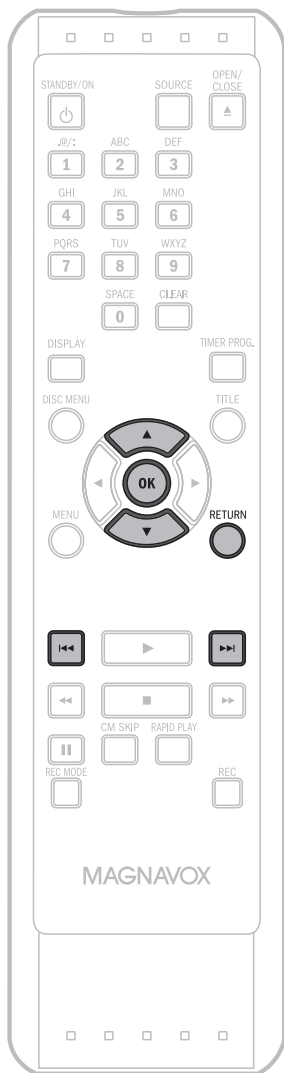

**1** Follow steps 1 to 3 in “Deleting a Title” on page 57 to display “Edit” menu.

**2** Use [▲ / ▼] to select “Hide Chapter”, then press [OK].  
Submenu will appear.

**3** Use [◀◀] / [▶▶] to decide the chapter to be hidden.

**4** Use [▲ / ▼] to select “Hidden”, then press [OK].

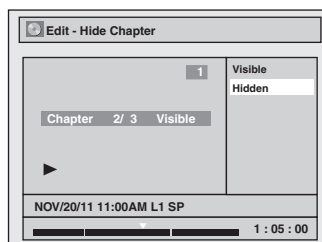

The chapter is now hidden.

**5** After this operation is completed, press [RETURN] twice to exit.  
Data will be written onto the disc momentarily.

**This operation may take a while to be completed.**

If you want hidden chapters to be “Visible”, select the chapter to be shown. Then use [▲ / ▼] to select “Visible” at the step 4 on this page.

Data will be written onto the disc momentarily.  
After the data is written, the list is displayed.

### Note

- “Hidden” will be displayed in the preview window while previewing the hidden chapter.
- When you make all chapters in the title “Hidden”, “Hidden” is displayed in a thumbnail of the title list.

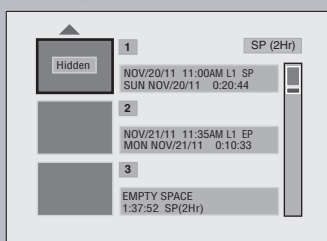

## Setting Pictures for Thumbnails

You can set your desired scene as a thumbnail for each title.

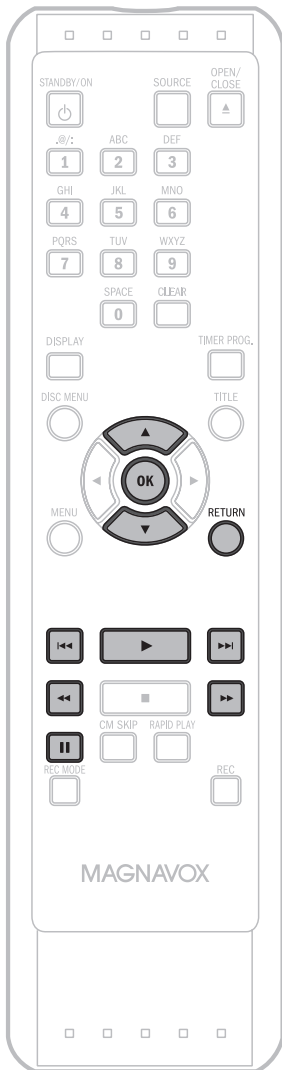

- 1** Follow steps 1 to 3 in “Deleting a Title” on page 57 to display “Edit” menu.
- 2** Use [◀◀], [▶▶], [◀◀], [▶▶], [PAUSE II] and [PLAY ▶] to decide the picture you want to select as a thumbnail.
- 3** Use [▲ / ▼] to select “Index Picture”, then press [OK].
- 4** Use [▲ / ▼] to select “Yes”, then press [OK].

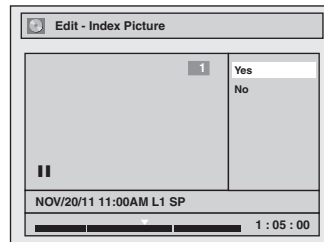

A picture for thumbnail will be set.

- 5** Press [RETURN] to exit.  
Data will be written onto the disc momentarily.
- This operation may take a while to be completed.**

### Note

- If the selected picture for a thumbnail is overwritten, the thumbnail is reset to the first scene of the title.

## Dividing a Title



You can divide one title into 2 new titles.



**1** Follow steps 1 to 3 in “Deleting a Title” on page 57 to display “Edit” menu.

**2** Use [◀◀], [▶▶], [◀◀], [▶▶], [PAUSE II] and [PLAY ▶] to decide the point at which you will divide the title.

**3** Use [▲ / ▼] to select “Title Dividing”, then press [OK].

**4** Use [▲ / ▼] to select “Yes”, then press [OK].

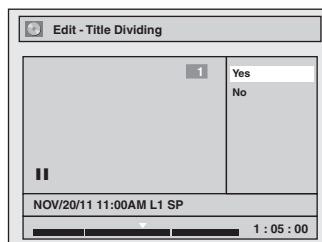

The title will be divided into 2 new titles. Both title names are identical, and thumbnails are reset to the first scene at this point.

Data will be written onto the disc momentarily.

**This operation may take a while to be completed.**

### Note

- You cannot divide a title of the disc when the number of recording titles reaches the maximum of 49, and the number of recording chapters reaches the maximum of 254.



## Putting Name on Disc

You can put a name on the disc and change it from this menu.

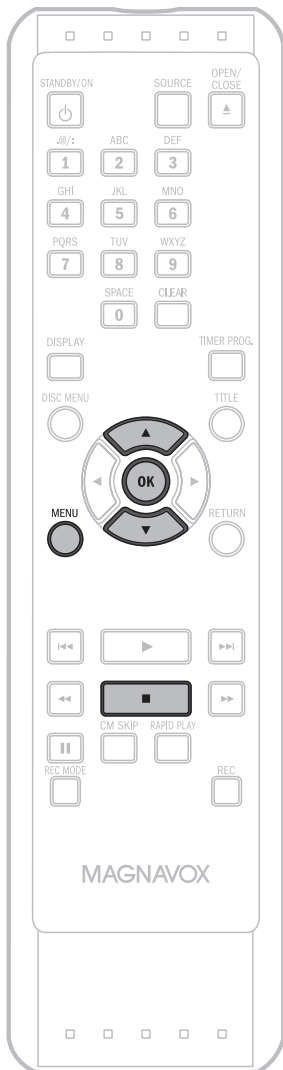

Press **[STOP ■]** if you are playing back a disc.

**1** Press **[MENU]**.

**2** Use **[▲ / ▼]** to select "Disc Edit", then press **[OK]**.

**3** Use **[▲ / ▼]** to select "Edit Disc Name", then press **[OK]**.  
e.g.) DVD+RW

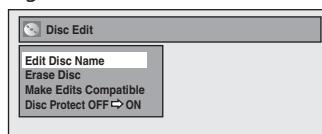

A window for entering a title name will appear.

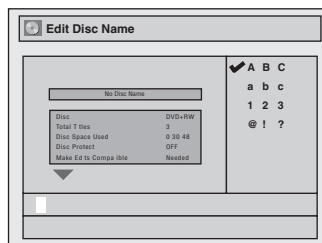

**4** To enter a disc name, follow the steps of "Guide to Edit Title Name" on page 58.

When you finish entering a title name, press **[OK]**.

**5** Use **[▲ / ▼]** to select "Yes", then press **[OK]**.

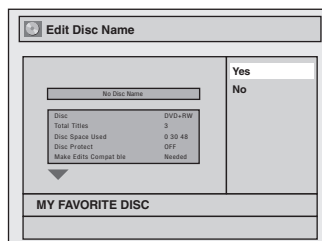

The name you entered will be activated for the title. Data will be written onto the disc momentarily.

### Note

- You cannot select "Disc Edit" when finalized DVD+R or DVD-R is inserted.

**This operation may take a while to be completed.**

## Erasing Disc



You can erase all titles on a disc.

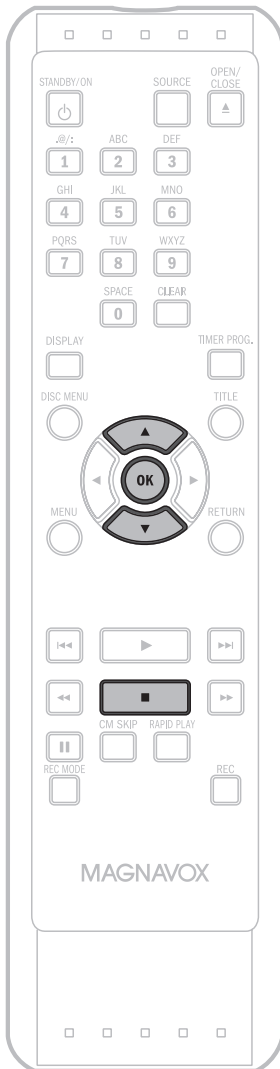

Press **[STOP ■]** if you are playing back a disc.

**1** Follow steps 1 to 2 in “Putting Name on Disc” on page 65 to display “Disc Edit” menu.

**2** Use **[▲ / ▼]** to select “Erase Disc”, then press **[OK]**.  
e.g.) DVD+RW

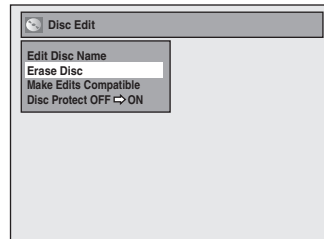

**3** Use **[▲ / ▼]** to select “Yes”, then press **[OK]**.

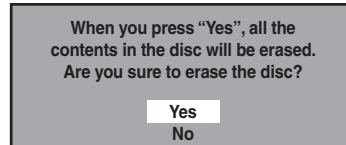

Data will be written onto the disc momentarily.

**This operation may take a while to be completed.**

The contents of the disc are now deleted.

### Note

- When you select “Yes” at step 3, all contents of the disc will be erased.

## Making Edits Compatible



If you have added or deleted chapters, or made chapters hidden, you must perform "Make Edits Compatible" to see those effects on another unit.

Press **[STOP ■]** if you are playing back a disc.

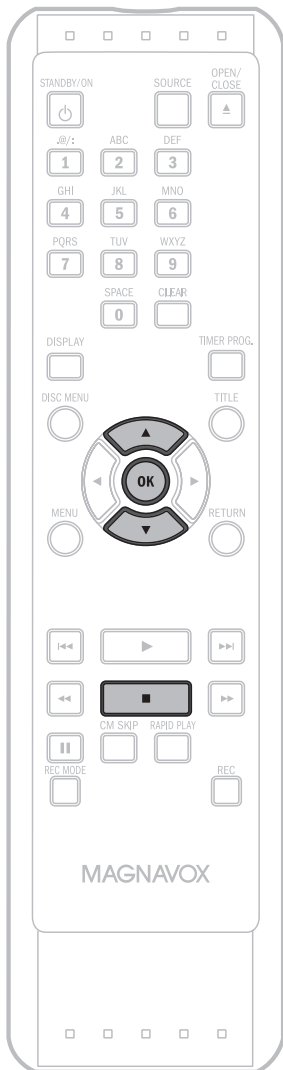

**1** Follow steps 1 to 2 in "Putting Name on Disc" on page 65 to display "Disc Edit" menu.

**2** Use **[▲ / ▼]** to select "Make Edits Compatible", then press **[OK]**.

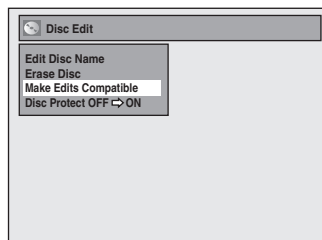

**3** Use **[▲ / ▼]** to select "Yes", then press **[OK]**.

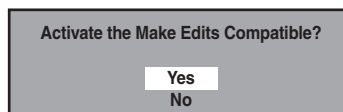

Data will be written onto the disc momentarily.

**This operation may take a while to be completed.**

# LIST OF SETTINGS

The following table is the contents which you can set and the default setting.  
Refer to the following table for useful operation.

Menu	Items (highlight is the default)		Contents	
Playback → Pages 70-72	Parental Lock		OFF level 8 [Adult] to 1 [Kid Safe]	Set the parental level for DVD playback.
	Disc Audio	Dynamic Range Control	ON OFF	Compressing the range of sound volume.
		PCM	48kHz 96kHz	Set whether the sound recorded in 96kHz will be down sampled in 48kHz.
		Dolby Digital	PCM Stream	Set the type of sound signal which outputs from the digital audio output jack.
	Disc Menu Language		English French Spanish Other	Set the language for disc menu language.
	Audio Language		Original English French Spanish Other	Set the language for audio.
	Subtitle Language		OFF English French Spanish Other	Set the language for subtitles.
	Angle Icon		ON OFF	Set whether or not to display the angle icon.
Still Mode		Auto Field Frame	Set the type of still image in pausing playback.	
General Setting Display → Pages 73-75	Language		English Français Español	Set the language for OSD (on-screen display).
	Screen Saver		OFF 1 minute 5 minutes 10 minutes 15 minutes	Set the idling time before the screen saver starts.
	V-Chip	MPAA Rating	X NC-17 R PG-13 PG G NR	Set the viewing limitation according to US movie ratings.
		TV Rating	TV-MA TV-14 TV-PG TV-G TV-Y7 TV-Y None	Set the viewing limitation according to US TV program ratings.
		Canadian English Rating	18+ 14+ PG G C8+ C E	Set the viewing limitation according to Canadian English language ratings.
		Canadian French Rating	18ans+ 16ans+ 13ans+ 8ans+ G E	Set the viewing limitation according to Canadian French language ratings.
		Change Password		Change the password.

# LIST OF SETTINGS

Menu	Items (highlight is the default)		Contents		
General Setting	Video → Page 76	Progressive Scan	ON OFF	Set to the progressive scan mode (set to "ON") or to the interlace scan mode (set to "OFF").	
		TV Aspect	4:3 Letter Box 4:3 Pan & Scan 16:9 Wide	Set a picture size according to aspect ratio of your TV.	
		Video Input → Page 36	L1(Rear)	Video In S-Video In	Set the video input type for the external input.
	L2(Front)		Video In S-Video In		
	Recording	Auto Chapter → Page 25	OFF 5 minutes 10 minutes 15 minutes 30 minutes 60 minutes	Insert chapter marks at preset time interval's.	
		Auto Finalize → Page 40	Disc Full	ON OFF	Set the unit to finalize the disc automatically.
			End of Timer Rec	ON OFF	
	Make Recording Compatible → Page 25		ON OFF	Set to prohibit additional recording (OFF) or to replace the title list after recording (ON).	
	Clock → Page 23	Clock Setting		Set the clock.	

## Note

- Your change to each setting stays on even when the power is off.
- An item which is not currently available is grayed in the settings.

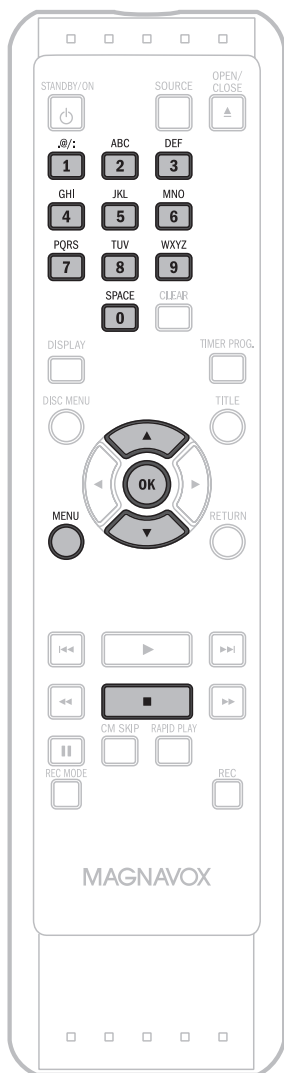

Press [STOP ■] if you are playing back a disc.

**1** Press [MENU] and use [▲ / ▼] to select "General Setting", then press [OK].

"General Setting" menu will appear.

**2** Use [▲ / ▼] to select "Playback", then press [OK].

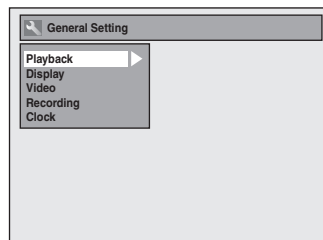

**3** Use [▲ / ▼] to select a desired item, then press [OK].

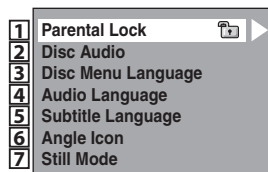

Submenu will appear.

**4** Refer to **1** to **7** on pages 71-72 and set the selected item.

**5** When you finish with setting, press [MENU] to exit.

## 1 Parental Lock (Default: OFF)

Some DVD-video feature a parental lock level. Playback will stop if the ratings exceed the levels you set, it will require you to enter a password before the disc will playback. This feature prevents your children from viewing inappropriate material.

Use **[▲ / ▼]** to select the desired level, then press **[OK]**.

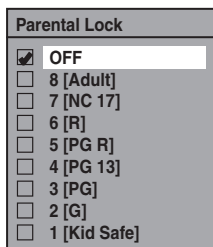

If a password has not been set yet, proceed to **A**.

If a password has been set already, proceed to **B**.

### Note

- Parental lock function may not be available to some discs.
- With some DVD, it may be difficult to find if they are compatible with parental lock. Be sure to check if the parental lock function operates in the way that you have set.
- Record the password in case you forget it.
- If there is a DVD in the unit when you set up the parental lock, press **[OPEN/CLOSE ▲]** to activate the parental lock level.

**A** A password has not been set yet.

Use **[▲ / ▼]** to select "Yes". Use **[the Number buttons]** to enter a new password except for 4737, then press **[OK]**.

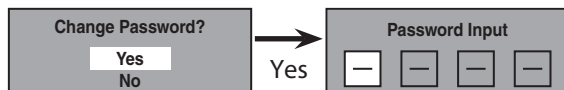

Your setting will be activated.

**B** A password has been set already.

• Use **[the Number buttons]** to enter the current password.



Your setting will be activated.

• If you want to change password, use **[▲ / ▼]** to select "Yes". Use **[the Number buttons]** to enter a new password except for 4737, then press **[OK]**.

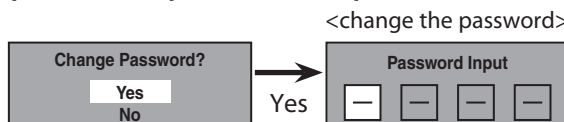

Your setting will be activated.

### Note

- Press **[CLEAR]** to erase numbers entered incorrectly.
- When you forget the password or you want to clear all settings in "Parental Lock" menu, enter 4737 using **[the Number buttons]** in password input window. Password will be cleared and parental levels will be set to "OFF".

## 2 Disc Audio

Choose the appropriate audio setting for your external device.

It will only affect a disc playback.

Use **[▲ / ▼]** to select a desired item, then press **[OK]**.

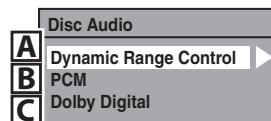

**A** Dynamic Range Control (Default : ON)

Set to "ON" to compress the range between soft and loud sounds.

Use **[▲ / ▼]** to select a setting, then press **[OK]**.

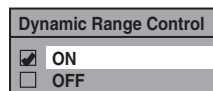

Your setting will be activated.

### Note

- Dynamic range control function is available only on the discs which are recorded in the Dolby Digital format.

**B** PCM (Default : 48kHz)

Use **[▲ / ▼]** to select a setting, then press **[OK]**.

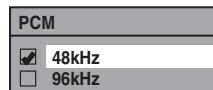

Your setting will be activated.

**48kHz** : If your amplifier/decoder is NOT compatible with 96kHz PCM, select "48kHz". 96kHz sound will be output in 48kHz.

**96kHz** : If your amplifier/decoder is compatible with 96kHz PCM, select "96kHz". 96kHz sound will be output.

### Note

**When playing back disc with copyright protection**

- Even if you select "96kHz", the sound will be down sampled at 48kHz.

## Playback (cont'd)

### C Dolby Digital (Default : Stream)

Use [▲ / ▼] to select a setting, then press [OK].

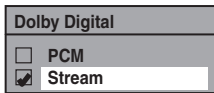

Your setting will be activated.

**PCM** : Converts the Dolby Digital into PCM (2 channel).  
When your amplifier/decoder is NOT compatible with Dolby Digital, set to "PCM".

**Stream** : Outputs Dolby Digital signals  
When your amplifier/decoder is compatible with Dolby Digital, set to "Stream".

### 3 Disc Menu Language (Default : English)

Set the language for disc menu.

Use [▲ / ▼] to select a setting, then press [OK].

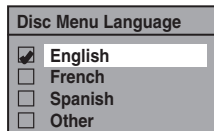

Your setting will be activated.

### 4 Audio Language (Default : Original)

Set the audio language.

Use [▲ / ▼] to select a setting, then press [OK].



Your setting will be activated.

• When "Original" is selected, the audio language will be in the disc's default language.

### 5 Subtitle Language (Default : OFF)

Set the subtitle language.

Use [▲ / ▼] to select a setting, then press [OK].

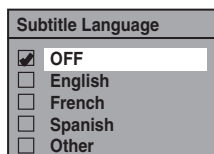

Your setting will be activated.

If "Other" is selected for [3] to [5], press 4-digit code using [the Number buttons].

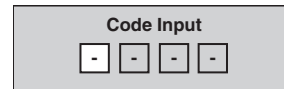

• When you finish entering the code, press [OK]. Refer to the language code table on page 80.

### Note

- Only the languages supported by the disc can be selected.
- Audio language setting may not be available to some discs.
- You can change or switch off the subtitles on a DVD also from the disc menu if it is available.
- Press [CLEAR] or [◀] to erase numbers entered incorrectly.

### 6 Angle Icon (Default : ON)

Set to "ON" to show the angle icon during the playback.

Use [▲ / ▼] to select a setting, then press [OK].

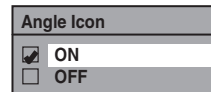

Your setting will be activated.

### 7 Still Mode (Default : Auto)

Select "Auto" usually.

Use [▲ / ▼] to select a setting, then press [OK].

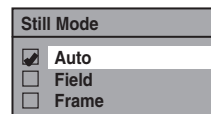

Your setting will be activated.

**Auto** : Optimum resolution setting ("Field" or "Frame") will be selected.

**Field** : Images in the still mode will be stabilized.

**Frame** : Images in the still mode will be highly defined.

### Note

- Frame is 1 completed video image made up of 2 fields (There are 30 frames per second of NTSC video).



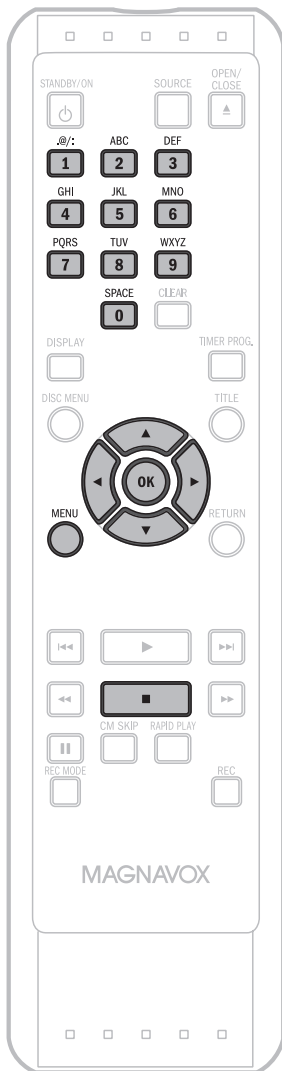

Press [STOP ■] if you are playing back a disc.

**1** Press [MENU] and use [▲ / ▼] to select "General Setting", then press [OK].

**2** Use [▲ / ▼] to select "Display", then press [OK].

**3** Use [▲ / ▼] to select a desired item, then press [OK].

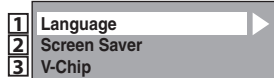

Selection menu will appear.

**4** Refer to **1** to **3** on pages 73-74 and set the selected item.

**5** When you finish with setting, press [MENU] to exit.

### **1** Language (Default : English)

Set the language for the on-screen display.

Use [▲ / ▼] to select a setting, then press [OK].



Your setting will be activated.

### **2** Screen Saver (Default : 10 minutes)

Set the time to activate the screen saver function on the TV screen.

Use [▲ / ▼] to select a setting, then press [OK].

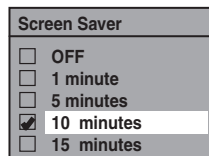

Your setting will be activated.

## Display (cont'd)

### 3 V-Chip

With the V-chip system in this unit, you can set the viewing limitation for the analog/digital TV programs received from the external tuner or recorded on DVDs to prevent your children from watching inappropriate programs. If the unit detects a blocked program, a restriction message appears and you are not allowed to view or record the program.

#### 1) Use [the Number buttons] to enter the access password.

If you have not set the password, first, use [the Number buttons] to set the access password, then press [OK]. The number you entered will be stored as the access password.



#### 2) Use [▲ / ▼] to select a desired item, then press [OK].

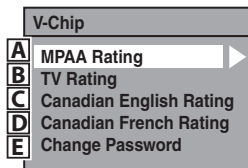

- A** MPAA Rating
- B** TV Rating
- C** Canadian English Rating
- D** Canadian French Rating

You can set the viewing limitation according to MPAA rating (US movie ratings), TV Rating (US TV program ratings), Canadian English Rating (Canadian English language Ratings), Canadian French Rating (Canadian French language Ratings).

#### 1) Use [▲ / ▼] to select the desired rating, then press [OK] repeatedly to switch between view and block. When it is blocked a key icon will appear.

e.g.) MPAA rating

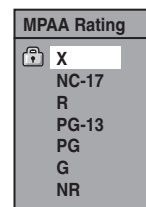

#### [MPAA Rating]

Rating	Category	
X	Mature audience only	higher ↑ ↓ lower
NC-17	No one under 17 admitted	
R	Restricted; under 17 requires accompanying parent or adult guardian	
PG-13	Unsuitable for children under 13	
PG	Parental guidance suggested	
G	General audience	
NR	No rating	

#### [TV Rating]

Rating	Category	
TV-MA	Mature audience only	higher ↑ ↓ lower
TV-14	Unsuitable for children under 14	
TV-PG	Parental guidance suggested	
TV-G	General audience	
TV-Y7	Appropriate for all children 7 and older	
TV-Y	Appropriate for all children	
None	No rating	

#### [Canadian English Rating]

Rating	Category	
18+	Adult audience only	higher ↑ ↓ lower
14+	Unsuitable for ages under 14	
PG	Parental guidance suggested	
G	General audience	
C8+	For children over 8	
C	For all children	
E	Exempt program	

# SETUPS

## [Canadian French Rating]

Rating	Category	
18ans+	Adult audience only	higher ↑ ↓ lower
16ans+	Unsuitable for ages under 16	
13ans+	Unsuitable for ages under 13	
8ans+	Unsuitable for ages under 8	
G	General audience	
E	Exempt program	

As for TV Rating's TV-MA, TV-14, TV-PG, or TV-Y7, you can further set the sub ratings to block specific elements of programming. Press [▲ / ▼ / ◀ / ▶] to select the desired rating or sub rating, then press [OK] repeatedly to switch between view and block. Sub rating status will appear on the side of the main rating.

TV Rating

FV V S L D

TV-MA	<input checked="" type="checkbox"/>	<input type="checkbox"/>	<input type="checkbox"/>	<input type="checkbox"/>
TV-14	<input type="checkbox"/>	<input type="checkbox"/>	<input type="checkbox"/>	<input type="checkbox"/>
TV-PG	<input type="checkbox"/>	<input type="checkbox"/>	<input type="checkbox"/>	<input type="checkbox"/>
TV-G				
TV-Y7	<input type="checkbox"/>			
TV-Y				
None				

Sub Rating	Category	Rating
FV	Fantasy Violence	TV-Y7
V	Violence	TV-PG
S	Sexual Situation	TV-14
L	Coarse Language	TV-MA
D	Suggestive Dialogue	TV-PG, TV-14

### Note

- Changing the main rating to block or view automatically changes all its sub ratings to the same (block or view).

## E

### Change Password

Change the current password.

Use [the Number Buttons] to enter new access password.

### Note

- When you forget the access password at step 1), enter 4737 using [the Number buttons] in the password input window. Password will be cleared.
- Depending on the type of rating system, you may set the levels individually.

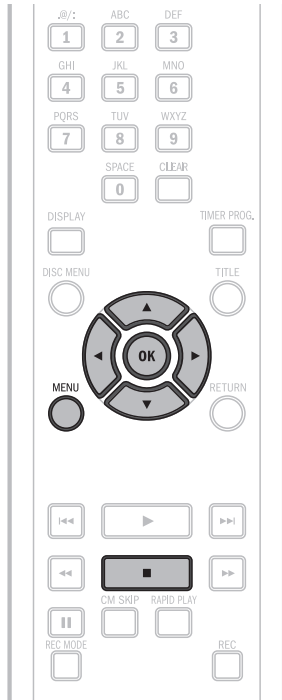

### 1 Progressive Scan (Default : OFF)

This unit is compatible with the progressive scan system. The feature provides you with the higher definition images than the traditional output system does. To utilize this feature, you must set progressive scan mode to "ON".

1) Use **[▲ / ▼]** to select "ON", then press **[OK]**.

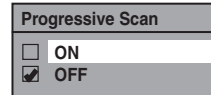

2) Use **[◀ / ▶]** to select "Yes", then press **[OK]**.

Activating progressive scan:  
Check your TV has progressive scan and connect with component video cable.

**NOTE :**

If there is no picture or picture is distorted after selecting "Yes", Wait about 15 seconds for auto recovery.

Activate? Yes No

3) Use **[▲ / ▼]** to select "Yes" within 15 seconds, then press **[OK]**.

Your setting will be activated.

### Note

- If your TV is compatible with progressive scan (480p), you are recommended to use the component video cables (commercially available) to connect this unit to the TV. (Refer to pages 14-15.) If not, use the RCA video cable and set the progressive scan to "OFF" or press and hold **[MENU]** for more than 3 seconds during DVD playback.
- When selecting "No" or not pressing any buttons on the unit or remote control within 15 seconds at step 3), progressive scan remains to be "OFF" (interlace scan).

Press **[STOP ■]** if you are playing back a disc.

**1** Press **[MENU]** and use **[▲ / ▼]** to select "General Setting", then press **[OK]**.

**2** Use **[▲ / ▼]** to select "Video", then press **[OK]**.

**3** Use **[▲ / ▼]** to select a desired item, then press **[OK]**.

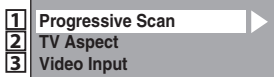

Submenu will appear.

**4** Refer to **1** to **2** on this page and set the selected item.

• For **3** refer to page 36.

**5** When you finish with setting, press **[MENU]** to exit.

### 2 TV Aspect (Default: 4:3 Letter Box)

You can select the TV aspect ratio to match the formats of what you are playing back or watching digital TV broadcasting with the unit and your TV screen (4:3 standard or 16:9 widescreen TV).

Use **[▲ / ▼]** to select a setting, then press **[OK]**.

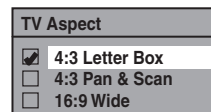

**If you have a standard TV:**

Select "4:3 Letter Box", so that black bars appear on the top and bottom of the TV screen when playing back a wide-screen picture. Select "4:3 Pan & Scan" for a full height picture with both sides trimmed when playing back wide-screen picture.

**If you have a widescreen TV:**

Select "16:9 Wide".

# TROUBLESHOOTING

Before requesting service for this unit, check the table below for a possible cause of the problem you are experiencing. Some simple checks or a minor adjustment on your part may eliminate the problem and restore proper operation.

	Symptom	Remedy
<b>POWER</b>	The power does not turn on.	<ul style="list-style-type: none"> <li>• Check that the AC power cord is connected securely.</li> <li>• Check the breaker (in case of power failure).</li> </ul>
	There is no picture.	<ul style="list-style-type: none"> <li>• Re-connect the connecting cords securely.</li> <li>• Check if the connecting cords are damaged.</li> <li>• If the main menu appears on the TV screen, press <b>[RETURN]</b> to exit.</li> <li>• Check the connection to your TV (pages 14-17).</li> <li>• Check if the progressive scan mode is set correctly according to your TV (page 76).</li> <li>• Switch the input selector on your TV (such as to "L1") so that the signal from the unit appears on the TV screen.</li> </ul>
<b>GENERAL</b>	Picture noise appears.	<ul style="list-style-type: none"> <li>• Clean the disc with a cleaning cloth.</li> </ul>
	Playback picture from the external devices connected to this unit is distorted.	<ul style="list-style-type: none"> <li>• If the picture output signal from the external devices passes through this unit to get to your TV, the copy protection signal applied to some DVD could affect the picture quality. Disconnect the playback device in question and connect it directly to your TV.</li> </ul>
	Playback picture is distorted.	<ul style="list-style-type: none"> <li>• Keep the device which may cause electrical disturbances, such as a cellular phone, away.</li> </ul>
	There is no sound.	<ul style="list-style-type: none"> <li>• Clean the disc with a cleaning cloth.</li> <li>• Re-connect all connections securely.</li> <li>• Check if the connecting cord is damaged.</li> <li>• Check the connections to the amplifier input.</li> <li>• Check if the input device setting on the amplifier is correct.</li> <li>• When the unit is in pause mode or in slow-motion playback mode, sound is not output. This is not a malfunction.</li> <li>• When the unit is in fast forward or fast reverse mode, sound is not output. This is not a malfunction.</li> <li>• If you are using COAXIAL DIGITAL AUDIO OUTPUT jack, check the setting in "Disc Audio" (pages 71-72).</li> <li>• While the menu or timer programming display is shown, or while the screen saver is active, the audio is muted.</li> </ul>
	Sound is noisy.	<ul style="list-style-type: none"> <li>• Clean the disc with a cleaning cloth.</li> </ul>
	No DTS sound is output.	<ul style="list-style-type: none"> <li>• This unit is not compatible with DTS sound.</li> </ul>
	Menu cannot be called up.	<ul style="list-style-type: none"> <li>• Menus cannot be called up during DVD recording or DVD playback.</li> </ul>
<b>REMOTE CONTROL</b>	The remote control does not function.	<ul style="list-style-type: none"> <li>• Batteries are weak.</li> <li>• There are obstacles between the remote control and the unit.</li> <li>• The remote control is far from the unit.</li> <li>• There are no batteries in the remote control.</li> <li>• Check if the unit is turned on.</li> <li>• Check if you are pointing the remote control at the recorder and NOT the TV.</li> </ul> <p>If you have a plasma TV, it may interfere with the IR signal. Try the remote with the plasma off. If the remote works, you may need to move the unit away from the plasma TV.</p>
<b>PLAYBACK</b>	The disc does not play back.	<ul style="list-style-type: none"> <li>• No disc is inserted.</li> <li>• A blank disc is inserted.</li> <li>• The disc is upside down. Insert the disc with the labeled side facing up.</li> <li>• The disc is not correctly inserted.</li> <li>• The unit cannot play back certain discs (such as a CD-ROM) (page 41).</li> <li>• The region code on the DVD-video does not match the unit (page 41).</li> <li>• Moisture has condensed inside the unit. Remove the disc and leave the unit turned on for about 2 hours until the moisture evaporates (page 3).</li> <li>• If the disc was recorded on another recorder, the unit cannot play back the disc if it was not finalized.</li> </ul>

# TROUBLESHOOTING

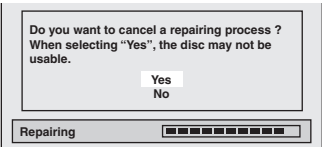
	Symptom	Remedy
PLAYBACK	Discs recorded on this unit cannot be played back on other DVD players.	<ul style="list-style-type: none"> <li>If you are using DVD+R, DVD-RW/-R disc, please ensure you finalized the disc after recording (page 39).</li> </ul>
	The disc does not start playback from the beginning.	<ul style="list-style-type: none"> <li>Resume playback was activated (page 48). Press <b>[STOP ■]</b> twice.</li> <li>You have inserted a disc whose title menu or DVD menu automatically appears on the TV screen when it is first insert.</li> </ul>
	The unit starts playing back the disc automatically.	<ul style="list-style-type: none"> <li>The DVD-video features an auto playback function.</li> </ul>
	Some functions such as stop, search, or slow-motion playback cannot be performed.	<ul style="list-style-type: none"> <li>Depending on the disc, you may not be able to do some of the operations. Refer to the manual supplied with the disc.</li> </ul>
	The language for the sound track cannot be changed.	<ul style="list-style-type: none"> <li>The title does not have the multilingual audio tracks.</li> <li>The DVD-video prohibits the changing of the language for the sound track.</li> </ul>
	The subtitle language cannot be changed or turned off.	<ul style="list-style-type: none"> <li>Multilingual subtitle are not recorded on the DVD-video.</li> </ul>
	The angles cannot be changed.	<ul style="list-style-type: none"> <li>Multi-angles are not recorded on the DVD-video being played back.</li> <li>The angle-change operation is whenever possible as long as the disc contains a multi-angle portion. Actual change will be performed when the portion has come up.</li> <li>The DVD-video prohibits changing angles.</li> <li>Try changing the angle using the DVD-video's menu.</li> </ul>
RECORDING	Nothing was recorded even though you set the timer setting correctly.	<ul style="list-style-type: none"> <li>There was a power failure during recording.</li> <li>The unit's internal clock stopped due to a power failure that lasted for more than 30 seconds. Reset the clock (page 23).</li> <li>The program contains copy protection signals that restricts copying.</li> <li>The timer setting overlapped with another setting that has priority.</li> </ul>
	Recording does not stop immediately after you press <b>[STOP ■]</b> .	<ul style="list-style-type: none"> <li>It may take a few seconds for the unit to input disc data before recording stops.</li> </ul>
	Timer recording is not complete or did not start from the beginning.	<ul style="list-style-type: none"> <li>The timer setting overlapped with another setting that has priority (page 31).</li> <li>Disc space was not enough.</li> </ul>
OTHERS	The unit does not operate properly.	<ul style="list-style-type: none"> <li>When static electricity, etc., causes the unit to operate abnormally, unplug the unit and then plug it in again.</li> </ul>
	The disc tray does not open when you press <b>[OPEN/CLOSE ▲]</b> .	<ul style="list-style-type: none"> <li>It may take a few seconds for the disc tray to open after you have recorded or edited a disc. This is because the unit is adding disc data to the disc.</li> </ul>
	<p>"Repairing" appears on the TV screen.</p> 	<ul style="list-style-type: none"> <li>If there is a power failure or unplugging during recording, finalizing, formatting or editing (even after "Repairing" disappears), a repairing process will begin automatically just after turning the unit on again. It may take several minutes up to several hours.</li> </ul>
	<p>In a case you intend to cancel the repairing process.</p> 	<ul style="list-style-type: none"> <li>If you intend to cancel the repairing process, press <b>[▲ OPEN/CLOSE]</b> on the front panel, then select "Yes" and press <b>[OK]</b>. After that, press <b>[OPEN/CLOSE ▲]</b> to take out the disc. <b>The disc canceled during the repairing process MAY NOT work.</b></li> </ul>

# TROUBLESHOOTING

Disc Error message	Cause	Solution
Disc Error — Please eject the disc. — Playback feature may not be available on this Disc.	<ul style="list-style-type: none"> <li>Unplayable disc is inserted in the unit.</li> <li>The disc is upside down.</li> </ul>	<ul style="list-style-type: none"> <li>Insert the standardized disc which bear the marks on page 41.</li> <li>Insert the disc with the labeled side facing up.</li> </ul>
Region Error — Please eject the disc. — Playback is not authorized in your region.	<ul style="list-style-type: none"> <li>Playback is not authorized in the region of the DVD-video which you inserted in the unit.</li> </ul>	<ul style="list-style-type: none"> <li>Insert the DVD-video with region codes 1 or ALL.</li> </ul>
Parental Lock On The current selected parental level prohibits playback.	<ul style="list-style-type: none"> <li>The current selected parental level prohibits playback.</li> </ul>	<ul style="list-style-type: none"> <li>Check "Parental Lock" setting in "Playback" menu (page 71).</li> </ul>
Recording Error This program is not allowed to be recorded.	<ul style="list-style-type: none"> <li>The recording function encountered the copy prohibited program.</li> </ul>	<ul style="list-style-type: none"> <li>You cannot record copy prohibited programs.</li> </ul>
Recording Error This program is not recordable in +VR mode.	<ul style="list-style-type: none"> <li>You are trying to record the copy-once program.</li> </ul>	<ul style="list-style-type: none"> <li>You cannot record the copy-once program.</li> </ul>
Recording Error Can not record on this disc.	<ul style="list-style-type: none"> <li>You are trying to record onto the disc which is unrecordable, or the disc status is unable to record.</li> <li>The disc is dirty.</li> <li>The disc is damaged.</li> </ul>	<ul style="list-style-type: none"> <li>Insert the recordable disc, and ensure the disc status satisfies the recording requirements (page 24).</li> <li>Clean the disc with a cleaning cloth.</li> <li>Replace the disc.</li> </ul>
Recording Error This disc is protected and not recordable.	<ul style="list-style-type: none"> <li>You are trying to record onto the protected disc which is set in "Disc Edit" menu.</li> </ul>	<ul style="list-style-type: none"> <li>Release the disc protect setting in "Disc Edit" menu (page 38).</li> </ul>
Recording Error Disc is full. (No area for new recording)	<ul style="list-style-type: none"> <li>You are trying to record onto the disc which has no space for recording.</li> </ul>	<ul style="list-style-type: none"> <li>Insert the recordable disc with enough recording space.</li> </ul>
Recording Error You cannot record more than 49 titles on one disc. (The maximum is 49)	<ul style="list-style-type: none"> <li>You are trying to record onto the disc on which the number of recording titles comes up to the maximum (49).</li> </ul>	<ul style="list-style-type: none"> <li>Delete unnecessary titles (page 57).</li> </ul>
Recording Error You cannot record more than 254 chapters on one disc. (The maximum is 254)	<ul style="list-style-type: none"> <li>You are trying to record onto the DVD+RW or DVD-RW on which the number of recording chapters comes up to the maximum (254).</li> </ul>	<ul style="list-style-type: none"> <li>Delete unnecessary chapter marks (pages 60-61).</li> </ul>
Recording Error You cannot record on this disc as Power Calibration Area is full.	<ul style="list-style-type: none"> <li>When recordings are performed repeatedly onto an unstable disc, this area may come up to be full.</li> <li>Every time you insert a disc for recording, the disc's working area will be taken up. And if you repeat this frequently, it will be used up sooner and you may not be able to record full 49 titles.</li> </ul>	<ul style="list-style-type: none"> <li>Insert a new disc.</li> </ul>
Recording Error This disc is already finalized.	<ul style="list-style-type: none"> <li>You are trying to record onto the disc already finalized.</li> </ul>	<ul style="list-style-type: none"> <li>Release the finalizing for this disc (page 39).</li> </ul>
Recording Error The disc has no recording compatibility. Set "Make Recording Compatible" to "ON" to convert the disc.	<ul style="list-style-type: none"> <li>You are trying to record onto the disc that had been recorded by other recorders.</li> </ul>	<ul style="list-style-type: none"> <li>Set "Make Recording Compatible" to "ON" to rewrite the menu, after that you will record to disc (page 25).</li> </ul>

\* If you are still having trouble with the unit after checking "TROUBLESHOOTING", write down the error code and the error description for calling our help line mentioned on the front page to locate an Authorized Service Center.

# LANGUAGE CODE

Language	Code	Language	Code	Language	Code
Abkhazian	4748	Hungarian	5467	Russian	6467
Afar	4747	Icelandic	5565	Samoaan	6559
Afrikaans	4752	Indonesian	5560	Sangho	6553
Albanian	6563	Interlingua	5547	Sanskrit	6547
Amharic	4759	Interlingue	5551	Scots Gaelic	5350
Arabic	4764	Inupiak	5557	Serbian	6564
Armenian	5471	Irish	5347	Serbo-Croatian	6554
Assamese	4765	Italian	5566	Sesotho	6566
Aymara	4771	Japanese	5647	Setswana	6660
Azerbaijani	4772	Javanese	5669	Shona	6560
Bashkir	4847	Kannada	5760	Sindhi	6550
Basque	5167	Kashmiri	5765	Singhalese	6555
Bengali;Bangla	4860	Kazakh	5757	Siswat	6565
Bhutani	5072	Kinyarwanda	6469	Slovak	6557
Bihari	4854	Kirghiz	5771	Slovenian	6558
Bislama	4855	Kirundi	6460	Somali	6561
Breton	4864	Korean	5761	Spanish	5165
Bulgarian	4853	Kurdish	5767	Sundanese	6567
Burmese	5971	Laothian	5861	Swahili	6569
Byelorussian	4851	Latin	5847	Swedish	6568
Cambodian	5759	Latvian; Lettish	5868	Tagalog	6658
Catalan	4947	Lingala	5860	Tajik	6653
Chinese	7254	Lithuanian	5866	Tamil	6647
Corsican	4961	Macedonian	5957	Tatar	6666
Croatian	5464	Malagasy	5953	Telugu	6651
Czech	4965	Malay	5965	Thai	6654
Danish	5047	Malayalam	5958	Tibetan	4861
Dutch	6058	Maltese	5966	Tigrinya	6655
English	5160	Maori	5955	Tonga	6661
Esperanto	5161	Marathi	5964	Tsonga	6665
Estonian	5166	Moldavian	5961	Turkish	6664
Faroese	5261	Mongolian	5960	Turkmen	6657
Fiji	5256	Nauru	6047	Twi	6669
Finnish	5255	Nepali	6051	Ukrainian	6757
French	5264	Norwegian	6061	Urdu	6764
Frisian	5271	Occitan	6149	Uzbek	6772
Galician	5358	Oriya	6164	Vietnamese	6855
Georgian	5747	Oromo (Afan)	6159	Volapuk	6861
German	5051	Panjabi	6247	Welsh	4971
Greek	5158	Pashto; Pushto	6265	Wolof	6961
Greenlandic	5758	Persian	5247	Xhosa	7054
Guarani	5360	Polish	6258	Yiddish	5655
Gujarati	5367	Portuguese	6266	Yoruba	7161
Hausa	5447	Quechua	6367	Zulu	7267
Hebrew	5569	Rhaeto-Romance	6459		
Hindi	5455	Romanian	6461		



## **Analog Audio**

An electrical signal that directly represents sound. Compare this to digital audio which can be an electrical signal, but is an indirect representation of sound. See also "Digital Audio".

## **Aspect Ratio**

The width of a TV screen relative to its height. Conventional TVs are 4:3 (in other words, the TV screen is almost square); widescreen models are 16:9 (the TV screen is almost twice as wide as it is high).

## **Chapter**

Just as a book is split up into several chapters, a title on a DVD is usually divided into chapters. See also "Title".

## **Component Video Output**

Each signal of luminance (Y) and component (P<sub>B</sub>/C<sub>B</sub>, P<sub>R</sub>/C<sub>R</sub>) is independent to output so that you can experience picture color as it is.

Also, due to compatibility with progressive video (480p), you can experience higher-density picture than that in interlace (480i).

## **Digital Audio**

An indirect representation of sound by numbers. During recording, the sound is measured at discrete intervals (44,100 times a second for CD audio) by an analog-to-digital converter, generating a stream of numbers. On playback, a digital-to-analog converter generates an analog signal based on these numbers. See also "Sampling Frequency" and "Analog Audio".

## **Dolby Digital**

The system to compress digital sound developed by Dolby Laboratories. It offers you sound of stereo(2ch) or multi channel audio.

## **Finalize**

To make DVD, which have been recorded on, possible to play back in DVD players. With this unit, it is possible to finalize DVD+R, DVD-RW, and DVD-R.

## **MP3 (MPEG audio layer 3)**

MP3 is a method of compressing files. You can copy MP3 files on CD-RW/-R from the computer and play back the files on this unit.

## **PBC (playback control) (video CD only)**

This function enables you to play back interactive software using a menu screen. See also "Video CD".

## **PCM (pulse code modulation)**

The most common system of encoding digital audio, found on CD and DAT. Excellent quality, but requires a lot of data compared to formats such as Dolby Digital and MPEG audio. For compatibility with digital audio recorders (CD, MD and DAT) and AV amplifiers with digital inputs, this unit can convert Dolby Digital and MPEG audio to PCM. See also "Digital Audio".

## **Progressive Scan (480p)**

A type of display that does not split each frame into fields, and instead scans directly through all the scan lines of each frame in order. Progressive scan provides less flickering and higher image resolution than traditional (480i) TV signals. Refer to page 76 for instructions on selective progressive scan mode.

## **Region Code**

Regions associate discs and players with particular areas of the world. This unit will only play back discs that have compatible region codes. You can find the region code of your unit by looking on the rear panel. Some discs are compatible with more than one region (or all regions).

## **Sampling Frequency**

The rate which sound is measured by a specified interval to turn into digital audio data. The numbers of sampling in one second defines as sampling frequency. The higher the rate, the better the sound quality.

## **SAP (secondary audio program)**

Sub-audio channel which is delivered separately from main-audio channel. This audio channel is used as an alternate in bilingual broadcasting.

## **S-Video Output**

It delivers independently each signal of color(C) and luminance(Y) to TV as video signals, so that higher-quality picture will be gained.

## **Title**

A collection of chapters on DVD. See also "Chapter".

## **Track**

Audio CD use tracks to divide up the content of a disc. The DVD equivalent is called a chapter. See also "Chapter".

## **Video CD**

A digital format for store video data in compact disc.

# SPECIFICATIONS

## General

Power requirements	120V AC, 60Hz
Power consumption	16W (standby: 1.8W)
Dimensions (width x height x depth)	12.8 x 2.4 x 10.6 inches (325 x 59 x 267mm)
Weight	3.97 lbs. ( 1.80kg )
Operating temperature	41°F (5°C) to 104°F (40°C)
Operating humidity	Less than 80% (no condensation)

## Recording

Recording format	+VR (video recording) format
Recording discs	DVD+Rewritable, DVD+Recordable DVD-Rewritable, DVD-Recordable (+VR mode only)

## Video recording format

Sampling frequency	13.5 MHz
Compression format	MPEG

## Audio recording format

Sampling frequency	48 kHz
Compression format	Dolby Digital

## Terminals

Front	<b>Audio input</b> RCA jack x 2	2V rms (input impedance: more than 22kΩ)			
	<b>Video input</b> RCA jack x 1	1Vp-p (75Ω)			
	<b>S-video input</b> Mini DIN 4-pin x 1	Y: 1Vp-p (75Ω)	C: 286mVp-p (75Ω)		
Rear	<b>Audio input</b> RCA jack x 2	2V rms (input impedance: more than 22kΩ)			
	<b>Audio output</b> RCA jack x 2	2V rms (output impedance: more than 1kΩ)			
	<b>Video input</b> RCA jack x 1	1Vp-p (75Ω)			
	<b>Video output</b> RCA jack x 1	1Vp-p (75Ω)			
	<b>S-video input</b> Mini DIN 4-pin x 1	Y: 1Vp-p (75Ω)	C: 286mVp-p (75Ω)		
	<b>S-video output</b> Mini DIN 4-pin x 1	Y: 1Vp-p (75Ω)	C: 286mVp-p (75Ω)		
	<b>Component video output</b> RCA jack x 3	Y: 1Vp-p (75Ω)	PB/CB: 700mVp-p (75Ω)	PR/CR: 700mVp-p (75Ω)	
	<b>Coaxial digital audio output</b> RCA jack x 1	500mVp-p (75Ω)			

## Note

- The specifications and design of this product are subject to change without notice.

## Discos Reproducibles

Este aparato es compatible con la reproducción de los siguientes discos y archivos.

Discos reproducibles	Logotipos
DVD-video	
DVD+RW	
DVD+R	
DVD-RW (Sólo discos en modo de video finalizados)	
DVD-R (Sólo discos en modo de video finalizados)	
CD-DA (CD de audio)	
CD de video	 
CD-RW	 
CD-R	 
Archivos reproducibles	Soportes
MP3	CD-RW/-R

**DVD** es una marca registrada de DVD Format/Logo Licensing Corporation.

## Códigos de Región

El número presente en el interior el globo se refiere a una región del mundo. Este aparato puede reproducir discos DVD que estén rotulados para ALL las regiones o para la región 1.



## Disco Grabable

Este aparato puede grabar a DVD+RW, DVD+R, DVD-RW y DVD-R.

Los discos DVD+R/DVD-R pueden ser grabados sólo una vez. Los discos DVD+RW/DVD-RW pueden ser grabados y borrados muchas veces.

**En este aparato los discos DVD-RW/-R serán grabados automáticamente en el modo DVD+VR.**

Logotipos	Atributos
 	Disco de 8 cm / 12 cm, un solo lado, una sola capa Tiempo de grabación máx. aprox. (modo SLP): 360 minutos (4,7 GB) (para 12 cm) 108 minutos (1,4 GB) (para 8 cm)
DVD+RW    DVD+R	
 	
DVD-RW    DVD-R	

• Los siguientes discos se recomiendan para obtener una buena calidad de grabación y han sido comprobados como compatibles con este aparato. Sin embargo, según sea la condición del medio el equipo podría no leer el disco correctamente.

Verbatim	DVD+R 8x,    DVD+RW 4x, DVD-R 8x,    DVD-RW 2x
JVC	DVD-RW 4x
Maxell	DVD+R 4x/8x/16x,    DVD-R 8x/16x
SONY	DVD+R 4x/8x/16x,    DVD+RW 4x
TDK	DVD+R 4x/8x/16x

El comportamiento de cualquier otro disco no está garantizado.

• **Usted puede reproducir discos DVD+RW en la mayoría de los reproductores de DVD sin finalizarlos. Sin embargo, si usted ha añadido o eliminado capítulos, u ocultado capítulos, debe ejecutar "Compatibilizar edic." antes de poder ver dichos efectos en otros equipos. (Consulte la página 67.) Para reproducir discos que no sean DVD+RW en otros reproductores de DVD, usted necesitará finalizarlos.**

## Disco no Grabable

- Un DVD-RW grabado en un modo distinto de +VR no será grabable en este aparato a menos que usted borre todo el contenido del disco. (Consulte la página 66.)
- Un DVD-R grabado en un modo distinto de +VR no será grabable en este aparato.

## Conexión Básica

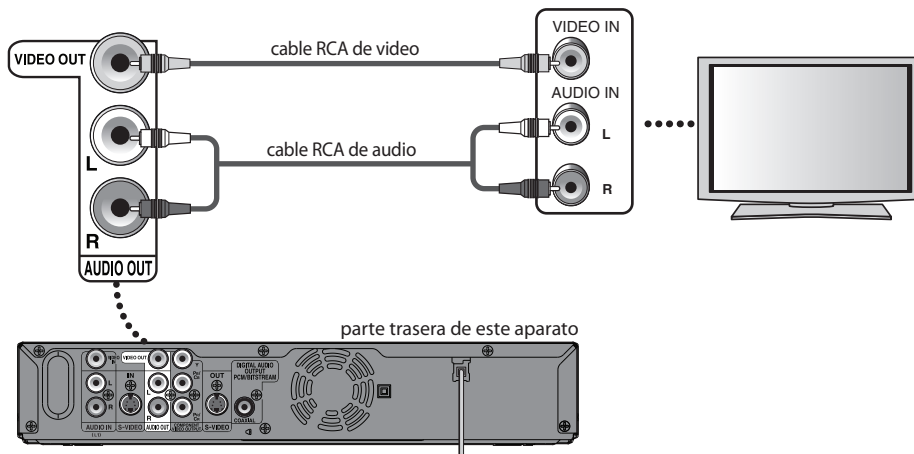

## Configuración Inicial

Cuando usted encienda este aparato por primera vez necesita seguir estos pasos.

### 1 Presione [STANDBY/ON ].

Encienda el televisor. Seleccione la entrada a la cual está conectado el aparato.

### 2 Utilice [ / ] para seleccionar su idioma deseado, y luego presione [OK] para establecerlo.

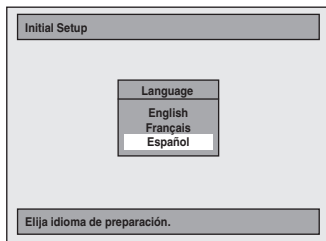

### 3 Utilice [ / ] para seleccionar un elemento a configurar, y utilice [ / ] para seleccionar el contenido de su preferencia, y luego presione [OK].

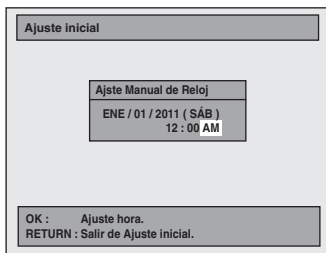

## Grabación Básica

### 1 Presione [OPEN/CLOSE ] para abrir la bandeja de discos e insertar su disco con el rótulo apuntando hacia arriba. Presione de nuevo [OPEN/CLOSE ] para cerrar la bandeja de discos.



\* Asegúrese de que el disco sea compatible con este aparato. (Para obtener la lista de discos compatibles consulte la página 83.)

### 2 Para seleccionar un modo de grabación presione [REC MODE].

Modo de grabación	Tiempo de grabación		Calidad del video y el sonido
	Disco de 8 cm	Disco de 12 cm	
HQ (1Hr)	18 min	60 min	Buena ↑ ↓ Deficiente
SP (2Hr)	36 min	120 min	
SPP (2.5Hr)	45 min	150 min	
LP (3Hr)	54 min	180 min	
EP (4Hr)	72 min	240 min	
SLP (6Hr)	108 min	360 min	

### 3 Presione [SOURCE] para seleccionar la posición adecuada de la entrada externa (L1/L2) a la cual está conectado su sintonizador externo. Luego seleccione en el sintonizador externo el canal que desea grabar.

### 4 Presione [REC] para iniciar la grabación.

#### Para configurar la grabación a un toque con temporizador (OTR)...

Esta es una manera sencilla de configurar el tiempo de grabación en bloques de 30 minutos. Presione [REC] repetidamente hasta que aparezca en la pantalla del televisor la longitud deseada de grabación (30 minutos a 6 horas). Comenzará la grabación a un toque con temporizador.

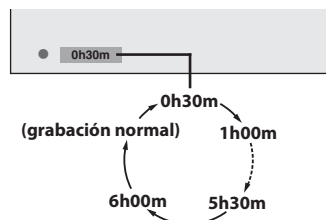

#### Para cambiar la duración de la grabación durante la grabación a un toque con temporizador:

Presione [REC] repetidamente hasta que aparezca la duración deseada.

#### Para cancelar la grabación a un toque con temporizador dentro del tiempo especificado:

Presione [STOP ].

### 5 Para de tener la grabación presione [STOP ].

## Grabación con Temporizador

Usted puede programar el equipo para que grabe hasta 12 programas, con un mes de anticipación. También hay disponibles grabaciones de programas diarias o semanales.

### Antes de grabar, asegúrese de que

- Cuando llegue el momento en que desea empezar a grabar, conecte el sintonizador externo a ya sea L1 o L2 y configúrelo para dar salida a las señales de audio/video.
- No cambie el canal del sintonizador externo cuando esté grabando. Usted no puede mirar un canal y grabar otro al mismo tiempo.
- Antes de establecer una programación del temporizador configure el reloj.
- Inserte un disco grabable con suficiente espacio libre.



**1** Presione [TIMER PROG.].

**2** Utilice [▲ / ▼] para seleccionar "Prog. nuevo", y luego presione [OK].

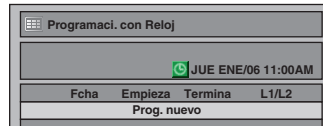

**3** Configure una programación del temporizador.

**4** Presione [OK].

**5** Presione [STANDBY/ON ⏻] para configurar una programación del temporizador.

Se iluminará el indicador TIMER REC en el panel delantero.

### Configure la fecha.



### Configure las horas de inicio y finalización.



### Seleccione un modo deseado de entrada y el canal a grabar.



### Seleccione un modo de grabación.



## Reproducción

**1** Presione [STANDBY/ON ].

STANDBY/ON



**2** Abra la bandeja de discos, y Inserte un disco.

OPEN/  
CLOSE

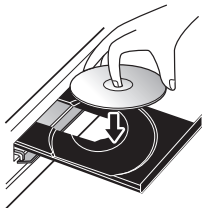

**3** Cerrar la bandeja de discos.

OPEN/  
CLOSE



**4** Comience a reproducir.



**5** Detenga la reproducción.



# MAGNAVOX

## LIMITED WARRANTY

FUNAI CORP. will repair this product, free of charge in the USA in the event of defect in materials or workmanship as follows:

### **DURATION:**

**PARTS:** FUNAI CORP. will provide parts to replace defective parts without charge for one (1) year from the date of original retail purchase. Certain parts are excluded from this warranty.

**LABOR:** FUNAI CORP. will provide the labor without charge for a period of ninety (90) days from the date of original retail purchase.

**Note: Any product sold and identified as refurbished or renewed carries a ninety (90) days labor and parts limited warranty.**

### **LIMITS AND EXCLUSIONS:**

THIS WARRANTY IS EXTENDED ONLY TO THE ORIGINAL RETAIL PURCHASER. A PURCHASE RECEIPT OR OTHER PROOF OF ORIGINAL RETAIL PURCHASE WILL BE REQUIRED TOGETHER WITH THE PRODUCT TO OBTAIN SERVICE UNDER THIS WARRANTY.

This warranty shall not be extended to any other person or transferee.

This warranty is void and of no effect if any serial numbers on the product are altered, replaced, defaced, missing or if service was attempted by an unauthorized service center. This limited warranty does not apply to any product not purchased and used in the United States.

This warranty only covers failures due to defects in material or workmanship which occur during normal use. It does not cover damage which occurs in shipment, or failures which are caused by repairs, alterations or products not supplied by FUNAI CORP., or damage, which results from accident, misuse, abuse, mishandling, misapplication, alteration, faulty installation, improper maintenance, commercial use such as hotel, rental or office use of this product, or damage which results from fire, flood, lightning or other acts of God.

THIS WARRANTY DOES NOT COVER PACKING MATERIALS, ANY ACCESSORIES (EXCEPT REMOTE CONTROL), ANY COSMETIC PARTS, COMPLETE ASSEMBLY PARTS, DEMO OR FLOOR MODELS.

FUNAI CORP. AND ITS REPRESENTATIVES OR AGENTS SHALL IN NO EVENT BE LIABLE FOR ANY GENERAL, INDIRECT OR CONSEQUENTIAL DAMAGES ARISING OUT OF OR OCCASIONED BY THE USE OF OR THE INABILITY TO USE THIS PRODUCT. THIS WARRANTY IS MADE IN LIEU OF ALL OTHER WARRANTIES, EXPRESS OR IMPLIED, AND OF ALL OTHER LIABILITIES ON THE PART OF FUNAI, ALL OTHER WARRANTIES INCLUDING THE WARRANTY OF MERCHANTABILITY AND FITNESS FOR A PARTICULAR PURPOSE, ARE HEREBY DISCLAIMED BY FUNAI AND ITS REPRESENTATIVES IN THE UNITED STATES.

ALL WARRANTY INSPECTIONS AND REPAIRS MUST BE PERFORMED BY AN AUTHORIZED SERVICE CENTER.

THIS WARRANTY IS ONLY VALID WHEN THE UNIT IS CARRIED-IN TO AN AUTHORIZED SERVICE CENTER.

THE PRODUCT MUST BE ACCOMPANIED BY A COPY OF THE ORIGINAL RETAIL PURCHASE RECEIPT. IF NO PROOF OF PURCHASE IS ATTACHED, THE WARRANTY WILL NOT BE HONORED AND REPAIR COSTS WILL BE CHARGED.

### **IMPORTANT:**

THIS LIMITED WARRANTY GIVES YOU SPECIFIC LEGAL RIGHTS. YOU MAY HAVE OTHER RIGHTS THAT VARY FROM STATE TO STATE. IF, AT ANY TIME DURING THE WARRANTY PERIOD, YOU ARE UNABLE TO OBTAIN SATISFACTION WITH THE REPAIR OF THIS PRODUCT, PLEASE CONTACT FUNAI CORP.

### **ATTENTION:**

FUNAI CORP. RESERVES THE RIGHT TO MODIFY ANY DESIGN OF THIS PRODUCT WITHOUT PRIOR NOTICE.

### **WARRANTY STATEMENT REGARDING NON AUTHORIZED REPAIRS:**

To obtain warranty service, you must take the product, or deliver the product freight prepaid, in either its original packaging or packaging affording an equal degree of protection, to any AUTHORIZED SERVICE CENTER. FUNAI CORP. will not reimburse you for any service done by unauthorized service providers without prior written approval.

**To locate your nearest AUTHORIZED SERVICE CENTER or for general service inquiries, please contact us at:**

**FUNAI SERVICE CORPORATION**

**Tel: 1-800-605-8610**

**[www.magnavox.com/support](http://www.magnavox.com/support)**

2200 Spiegel Drive Groveport, OH 43125





## Free Manuals Download Website

<http://myh66.com>

<http://usermanuals.us>

<http://www.somanuals.com>

<http://www.4manuals.cc>

<http://www.manual-lib.com>

<http://www.404manual.com>

<http://www.luxmanual.com>

<http://aubethermostatmanual.com>

Golf course search by state

<http://golfingnear.com>

Email search by domain

<http://emailbydomain.com>

Auto manuals search

<http://auto.somanuals.com>

TV manuals search

<http://tv.somanuals.com>