

Product: Simple DFU
Date: 2007/12/05

Paper size:
sheet - 960x470mm
folded - 160x235

material: paper 80g
color: cmyk
Printing: Both two sides

5 Precaution **4** Safety **3** Welcome **2** Mounting the TV stand **1** What's in the box

ADDITIONAL SAFETY PRECAUTIONS

- ENSURE that LCD TV stand is tightened properly to the set on the right way of tightening of the screw of the stand to the set. Improper tightening of screw may render the set unsafe.
- If LCD TV is installed on the wall, installation should be carried out by qualified servicemen. Improper or incorrect installation may render the set unsafe.
- Disconnect main plug when:
 - cleaning the TV screen, never use abrasive cleaning agents.
 - there is a lightning storm.
 - the set is left unattended for a prolonged period of time.
 - Do not shift or move the LCD TV around when it is powered on.
 - Do not touch, push or rub the surface of the LCD screen with any sharp or hard objects.
 - When the surface of the LCD screen becomes dusty, wipe it gently with an absorbent cotton cloth or other soft material like chamois. DO NOT USE acetone, toluene or alcohol to clean the surface of the screen. These chemicals will cause damage to the surface.
 - Wipe off water or saliva as soon as possible. These liquids can cause deformation and color fading of the LCD screen when left exposed for some time.
 - Be careful of condensation when temperature changes occur. Condensation can cause damage to the LCD screen and electrical parts. After condensation fades, spots or blemishes will be present on the LCD screen.
- POSITIONING THE LCD TELEVISION
- Place the LCD TV on a solid, sturdy base or stand. Be sure the stand is strong enough to handle the weight of the LCD TV.
- Try to leave at least 6" of space around each side of the LCD TV cabinet to allow for proper ventilation.
- If the TV is mounted on a swivel base or swivel arm, ensure no strain is placed on the AC power cord when the TV is swivelled. Strain on the power cord can loosen connections. This may cause arcing and result in fire.
- Do not place the LCD TV where it can be exposed to rain or excessive moisture.

This product contains mercury - and must be recycled or disposed of according to local, state or federal laws. As this material may be regulated due to environmental considerations, please contact your local authorities or the Electronic Industries Alliance: www.eiae.org.

Like all LCD products, this set contains a lamp with Mercury. Please dispose of according to all Local, State and Federal Laws. For the disposal or recycling information, contact: www.mygreenelectronics.com or www.eiae.org

IMPORTANT SAFETY INSTRUCTIONS
Read before operating equipment

- Read and keep these instructions.
- Keep all warnings.
- Follow all instructions.
- Do not insert any strange object into the ventilation slots. This might lead to damage of the TV.
- Do not use this apparatus near water.
- Clean only with a dry cloth.
- Do not block any of the ventilation openings.
- Install in accordance with the manufacturer's instructions.
- Do not install near any heat sources such as radiators, heat registers, stoves, or other apparatus (including amplifiers) that produce heat.
- Do not defeat the safety purpose of the polarized or grounding-type plug. A polarized plug has two blades with one wider than the other. A grounding type plug has two blades and third grounding prong. The wide blade or third prong are provided for your safety. When the provided plug does not fit into your outlet, consult an electrician for replacement of the obsolete outlet.
- Protect the power cord from being walked on or pinched particularly at plugs, convenience receptacles, and the point where they exit from the apparatus.
- Only use attachments/accessories specified by the manufacturer.
- Use only with a cart, stand, tripod, bracket, or table specified by the manufacturer, or sold with the apparatus. When a cart is used, use caution when moving the cart/apparatus combination to avoid injury from tip-over.
- Unplug this apparatus during lightning storms or when unused for long periods of time.
- Refer all servicing to qualified service personnel. Servicing is required when the apparatus has been damaged in any way, such as power-supply cord or plug is damaged, liquid has been spilled or objects have fallen into the apparatus, the apparatus has been exposed to rain or moisture, does not operate normally, or has been dropped.
- This product may contain lead or mercury. Disposal of these materials may be regulated due to environmental considerations. For disposal or recycling information, please contact your local authorities or the Electronic Industries Alliance www.eiae.org.
- Damage Requiring Service - The appliance should be serviced by qualified service personnel when:
 - The power supply cord or the plug has been damaged.
 - Objects have fallen, or liquid has been spilled into the appliance.
 - The appliance has been exposed to rain.
 - The appliance does not appear to operate normally or exhibits a marked change in performance.
 - The appliance has been dropped, or the enclosure damaged.
- Tilt/Stability - All televisions must comply with recommended international safety standards for tilt and stability properties of its cabinet design.
 - Do not compromise these design standards by applying excessive pull force to the front, or top, of the cabinet which could ultimately overturn the product.
 - Also, do not endanger yourself or children, by placing electronic equipments on top of the cabinet. Such items could unsafely fall from the top of the set and cause product damage and/or personal injury.
- Wall or Ceiling Mounting - The appliance should be mounted to a wall or ceiling only as recommended by the manufacturer.
- Power Lines - An outdoor antenna should be located away from power lines.
- Outdoor Antenna Grounding - If an outside antenna is connected to the receiver, be sure the antenna system is grounded so as to provide some protection against voltage surges and built-up static charges. Section 810 of the National Electric Code, ANSI/NFPA, Section 900 of the National Electric Code, and Underwriters Laboratories Inc. provides information with respect to proper grounding of the mast and supporting structure, grounding of the lead-in wire to an antenna discharge unit, size of grounding conductors, location of antenna-discharge unit, connection to grounding electrodes, and requirements for the grounding electrode. See Figure below.
- Object and Liquid Entry - Care should be taken so that objects do not fall and liquids are not spilled into the enclosure through openings.
- Battery Usage CAUTION - To prevent battery leakage that may result in bodily injury, property damage, or damage to the unit:
 - Install all batteries correctly, with + and - aligned as marked on the unit.
 - Do not mix batteries (old and new or carbon and alkaline, etc.)
 - Remove batteries when the unit is not used for a long time.

Example of Antenna Grounding as per NEC - National Electric Code

Notes to the CATV system installer: This reminder is provided to call the CATV system installer's attention to Article 820-49 of the NEC. This provides guidelines for proper grounding and, in particular, specifies that the antenna ground shall be connected to the grounding system of the building, as close to the point of cable entry as practical.

Return your Product Registration Card or register online at www.magnavox.com/usasupport today to get the very most from your purchase.

Registering your model with MAGNAVOX makes you eligible for all of the valuable benefits listed below, so don't miss out. Complete and return your Product Registration Card at once, or register online at www.magnavox.com/usasupport to ensure:

- *Proof of Purchase Notification** - Returning the enclosed card guarantees that your date of purchase will be on file, so no additional paperwork will be required from you to obtain warranty service.
- *Product Safety** - By registering your product, you'll receive notification directly from the manufacturer - in the rare case of a product recall or safety defect.
- *Additional Benefits** - Registering your product guarantees that you'll receive all of the privileges to which you're entitled, including special money-saving offers.

MAGNAVOX
Congratulations on your purchase, and welcome to the "family!"

Dear MAGNAVOX product owner: Thank you for your confidence in MAGNAVOX. You've selected one of the best-built, best-valued products available today. We'll do everything in our power to keep you happy with your purchase for many years to come.

As a member of the MAGNAVOX "family," you're entitled to protection by one of the most comprehensive warranties and outstanding service networks in the industry. What's more, your purchase guarantees you'll receive all the information and special offers for which you qualify, plus easy access to accessories from our convenient home shopping network.

Most importantly, you can count on our uncompromising commitment to your total satisfaction. All of this is our way of saying welcome - and thanks for investing in a MAGNAVOX product.

PS. To get the most from your MAGNAVOX purchase, be sure to complete and return your Product Registration Card at once or register online at www.magnavox.com/usasupport

MAGNAVOX Visit our World Wide Web Site at <http://www.magnavox.com/usasupport>

Know these safety symbols

This "bolt of lightning" indicates uninsulated material within your unit may cause an electrical shock. For the safety of everyone in your household, please do not remove product covering.

The "exclamation point" calls attention to features for which you should read the enclosed literature closely to prevent operating and maintenance problems.

WARNING: To reduce the risk of fire or electric shock, this apparatus should not be exposed to rain or moisture and objects filled with liquids, such as vases, should not be placed on this apparatus.

CAUTION: To prevent electric shock, reach wide blade of plug to wide slot, fully insert.

ATTENTION: Pour éviter les choc électriques, introduire la lame la plus large de la fiche dans la borne correspondante de la prise et pousser jusqu'au fond.

For Customer Use
Enter below the Serial No. which is located on the rear of the cabinet. Retain the information for future reference.
Model No. _____
Serial No. _____

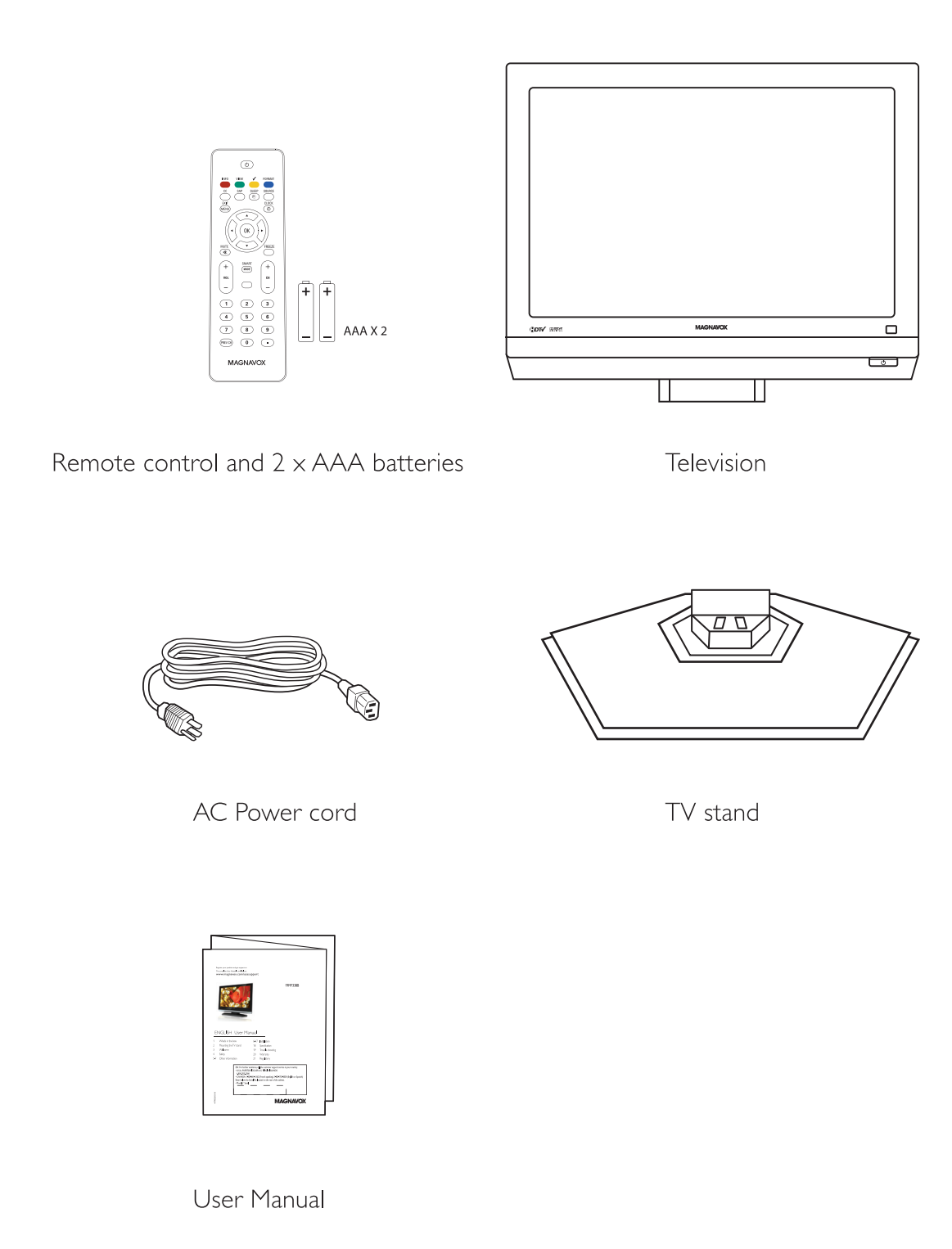
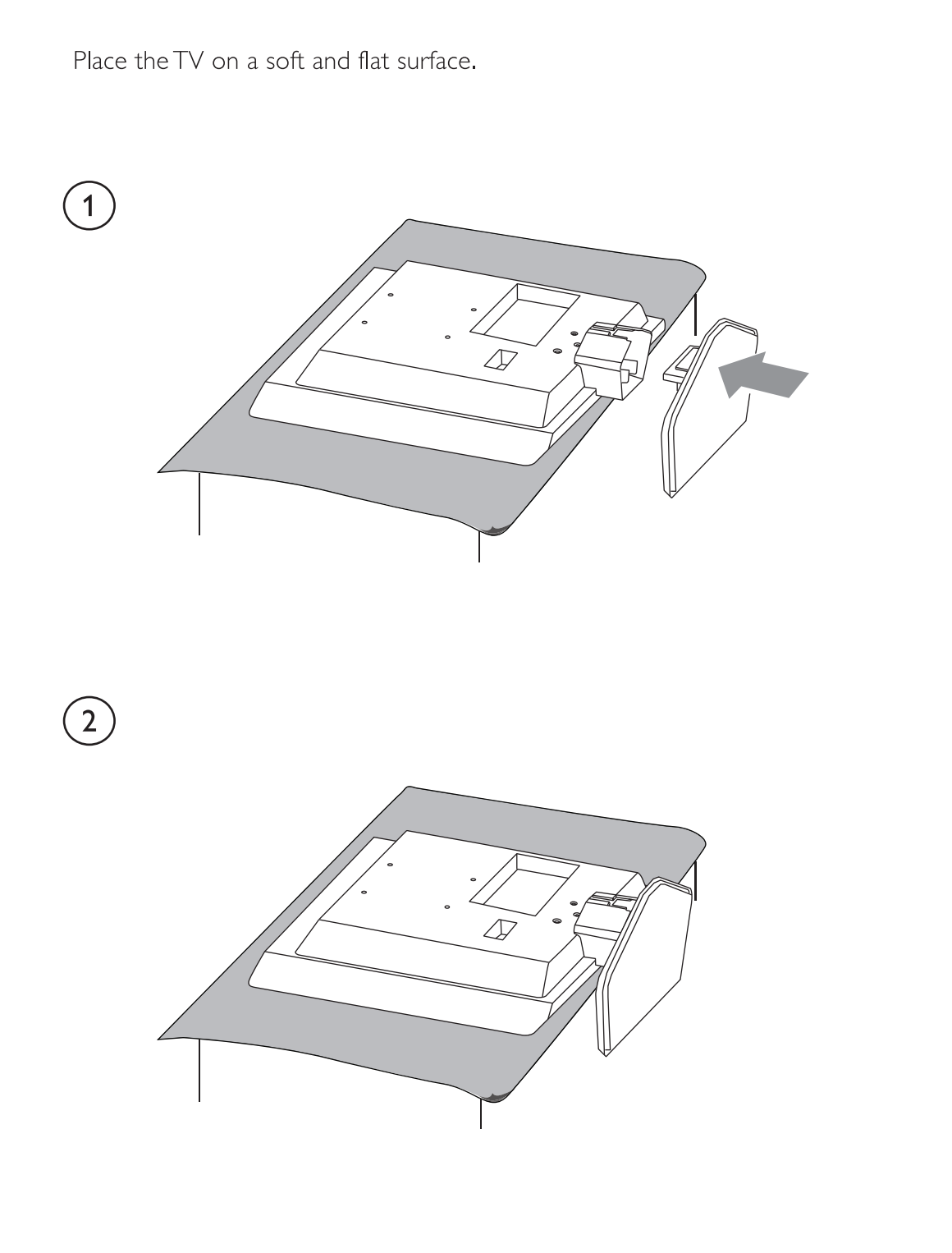

Register your product and get support at:
The complete User Manual is available at: www.magnavox.com/usasupport

ENGLISH User Manual

1 What's in the box	8-17 Installation
2 Mounting the TV stand	18 Specification
3 Welcome	19 Trouble shooting
4 Safety	20 Warranty
5-7 Other information	21 Regulatory

EN: For further assistance, call the customer support service in your country.
• USA, PUERTO RICO OR U.S. VIRGIN ISLANDS: 1-800-705-2000
• CANADA: 1-800-661-6162 (French speaking), 1-800-705-2000 (English or Spanish)
Enter below the Serial No. located on the rear of the cabinet.
• Model / Serial

MAGNAVOX

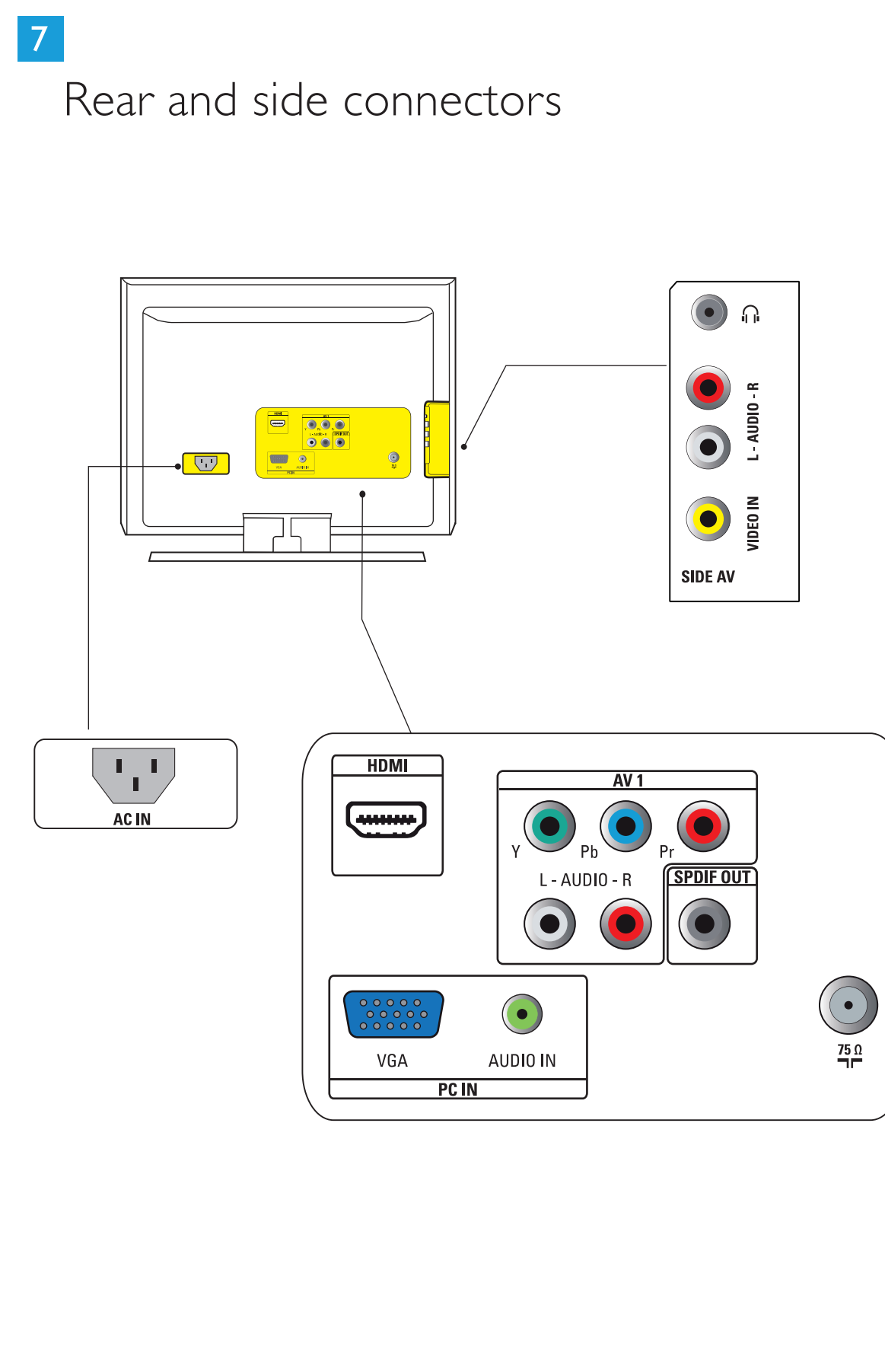
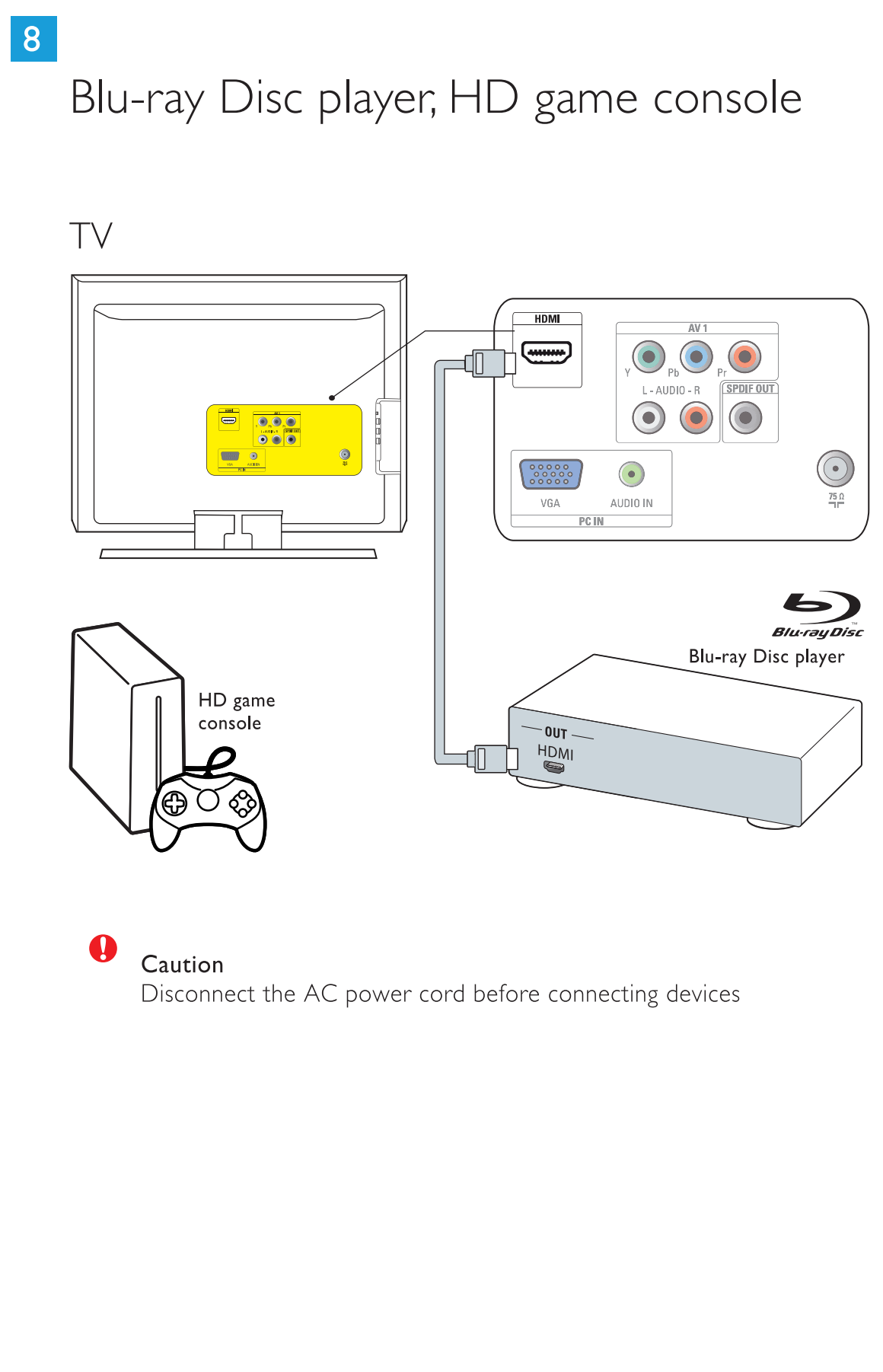
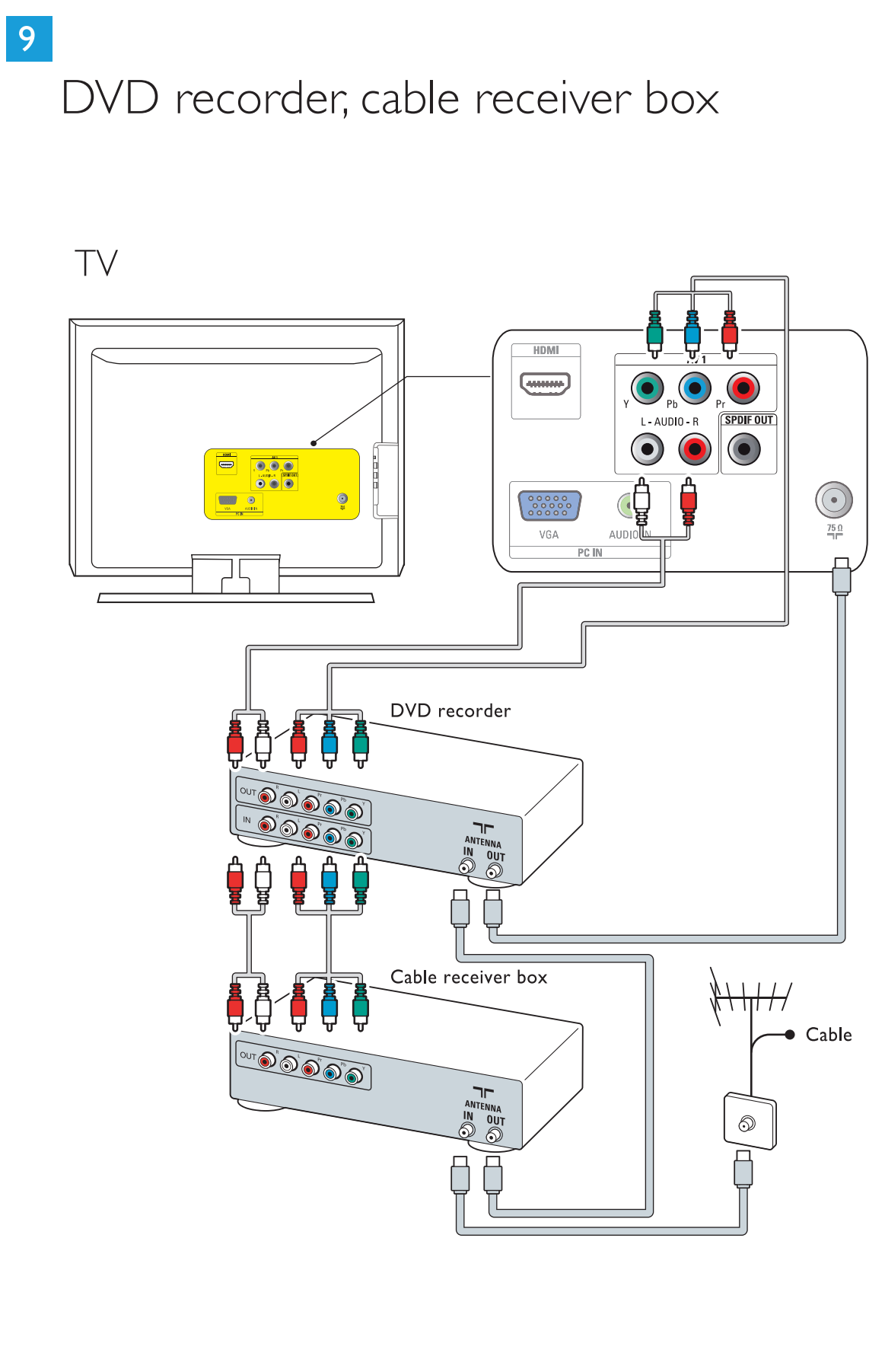
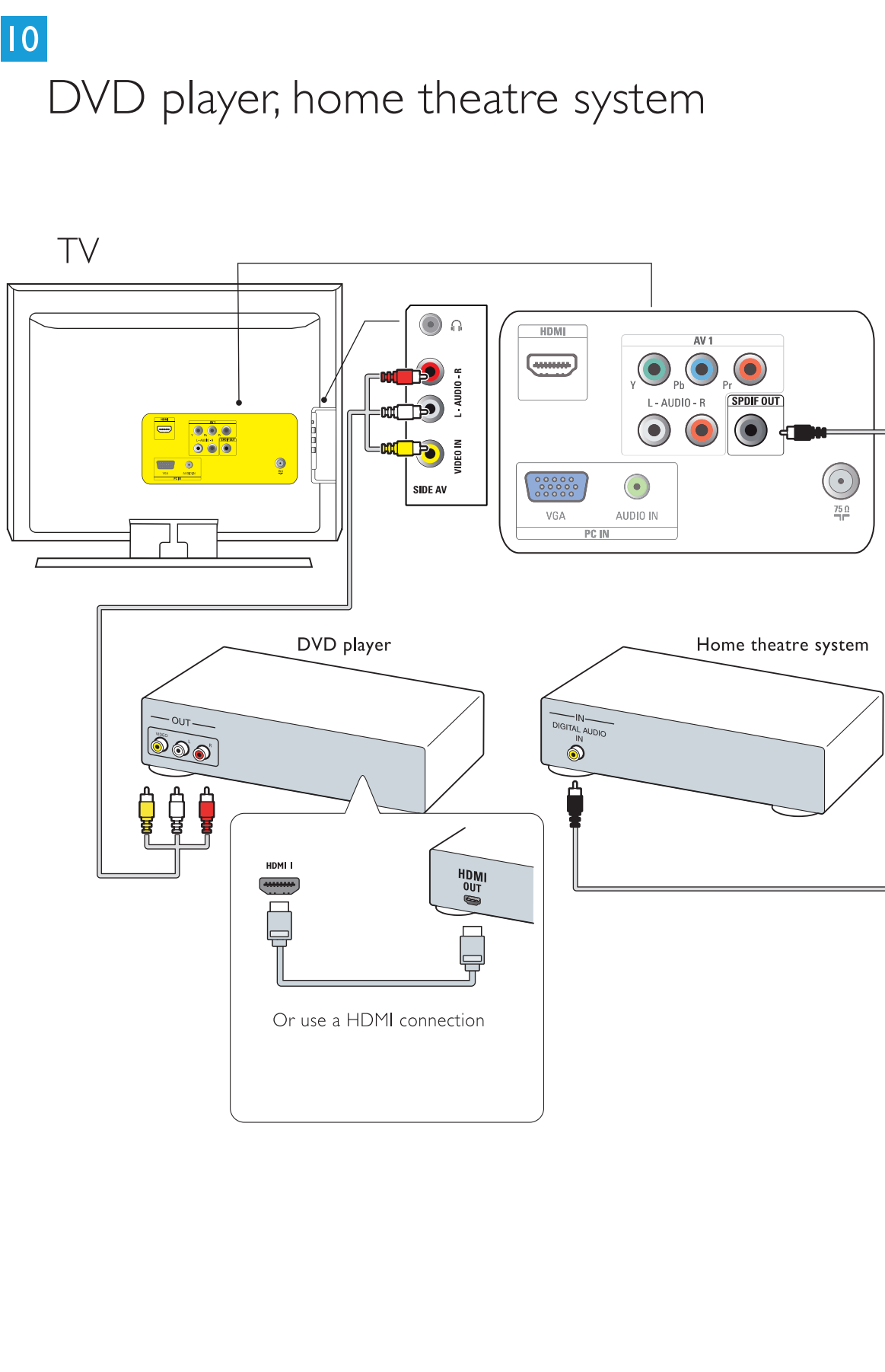
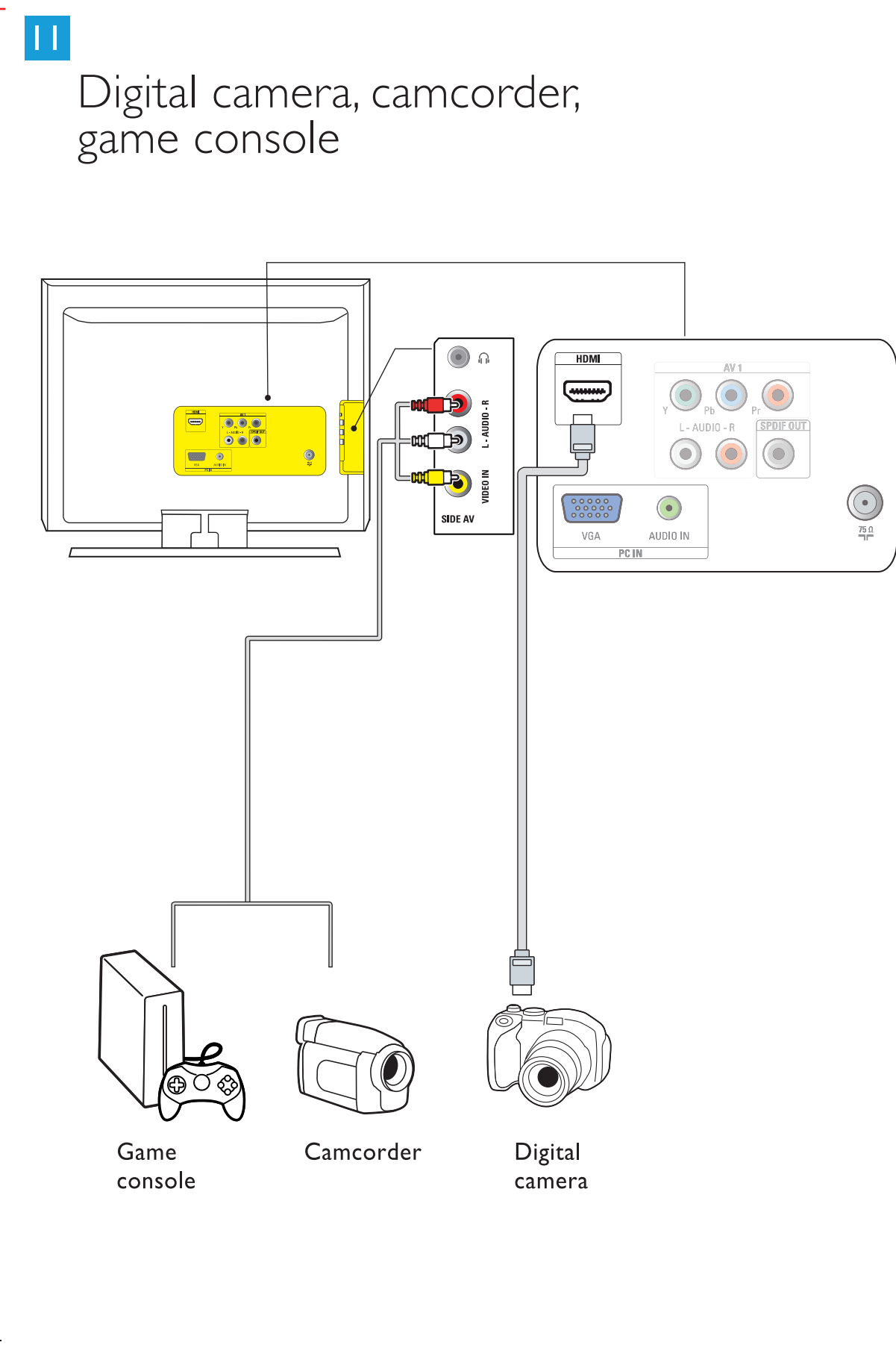

6 Other information

If this User Manual does not provide an answer or if the "Trouble Shooting Tips" do not solve your TV problem, you can call the Magnavox Customer Care Center at 1 800 705 2000. Please have your model and serial number of your TV before making this call. You can find your TV's model and serial number located on a sticker on the front of this User Manual or on the back side of the TV.

ENERGY STAR
As an ENERGY STAR® Partner, Magnavox has determined this product meets the ENERGY STAR® guidelines for energy efficiency. ENERGY STAR® is a U.S. registered mark. Using products with ENERGY STAR® label can save energy. Saving energy reduces air pollution and lowers utility bills.

DOLBY DIGITAL
Manufactured under license from Dolby Laboratories. "Dolby" and the double-D symbol are trademarks of Dolby Laboratories.

Magnavox has paid a lot of attention to producing an environmentally friendly product. Your new TV contains several materials that can be recycled for new uses. At the end of its life, specialized companies can dismantle and recycle this set. This will minimize the amount of materials being disposed of. Please be sure to dispose of this set in accordance with all state and local regulations. Like all LCD products, this set contains a lamp with Mercury, please dispose of according to all Local, State and Federal laws.

Pixel characteristics
Your TV display is made with high-precision technology with a high number of color pixels. Although it has effective pixels of 99,999% or more, black dots or bright points of light (red, green or blue) may appear constantly on the screen. This is a structural property of the display (within common industry standards) and is not a malfunction.

Printed in China

Remove the TV stand

Place the TV on a soft and flat surface.

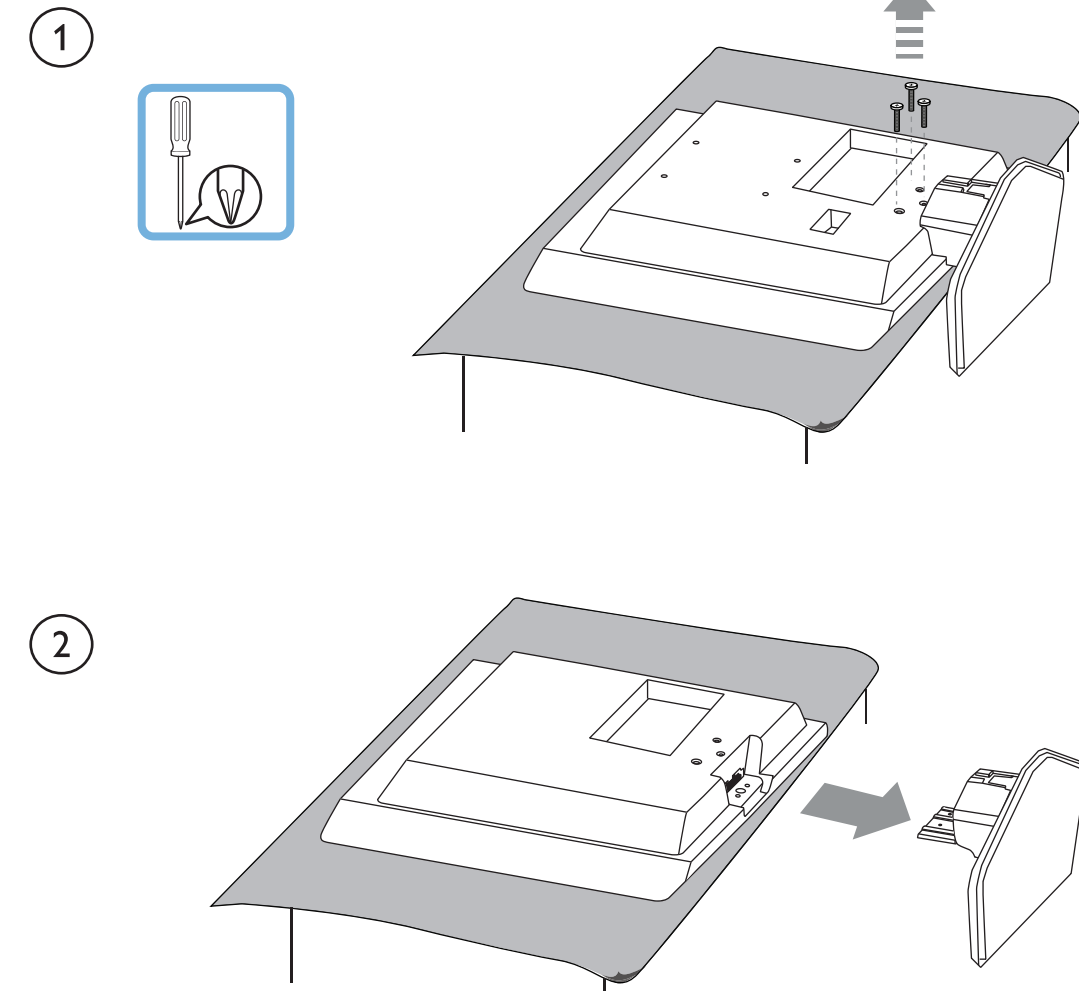

The complete User Manual is available at www.magnavox.com/usasupport. To purchase a bracket, visit www.shoppings.philips.com/wallmounts.

Regulatory

FCC Declaration of Conformity

Trade Name: Magnavox
Responsible Party: Philips Consumer Lifestyle, a division of Philips Electronics North America Corporation
P.O. Box 671539
Marietta, GA 30066-0026
1-888-PHILIPS (744-5477)
Declaration of Conformity for Products Marked with FCC Logo, United States Only



This device complies with Part 15 of the FCC Rules. Operation is subject to the following two conditions: (1) this device may not cause harmful interference, and (2) this device must accept any interference received, including interference that may cause undesired operation.

Regulatory Notices-Federal Communications Commission Notice

This equipment has been tested and found to comply with the limits for a Class B digital device, pursuant to part 15 of the FCC Rules. These limits are designed to provide reasonable protection against harmful interference in a residential installation. This equipment generates, uses, and can radiate radio frequency energy and, if not installed and used in accordance with the instructions, may cause harmful interference to radio communications. However, there is no guarantee that interference will not occur in a particular installation. If this equipment does cause harmful interference to radio or television reception, which can be determined by turning the equipment off and on, the user is encouraged to try to correct the interference by one or more of the following measures: Reorient or relocate the receiving antenna. Increase the separation between the equipment and the receiver.

Connect the equipment into an outlet on a circuit different from that to which the receiver is connected. Consult the dealer or an experienced radio or television technician for help.

Modifications - The FCC requires the user to be notified that any changes or modifications made to this device that are not expressly approved by Philips Consumer Lifestyle may void the user's authority to operate the equipment.

Cables - Connections to this device must be made with shielded cables with metallic RF/EMI connector hoods to maintain compliance with FCC Rules and Regulations.

Canadian notice - This Class B digital apparatus meets all requirements of the Canadian Interference-Causing Equipment Regulations.

Avis Canadien - Cet appareil numérique de la classe B respecte toutes les exigences du Règlement sur le matériel brouilleur du Canada.

First time setup

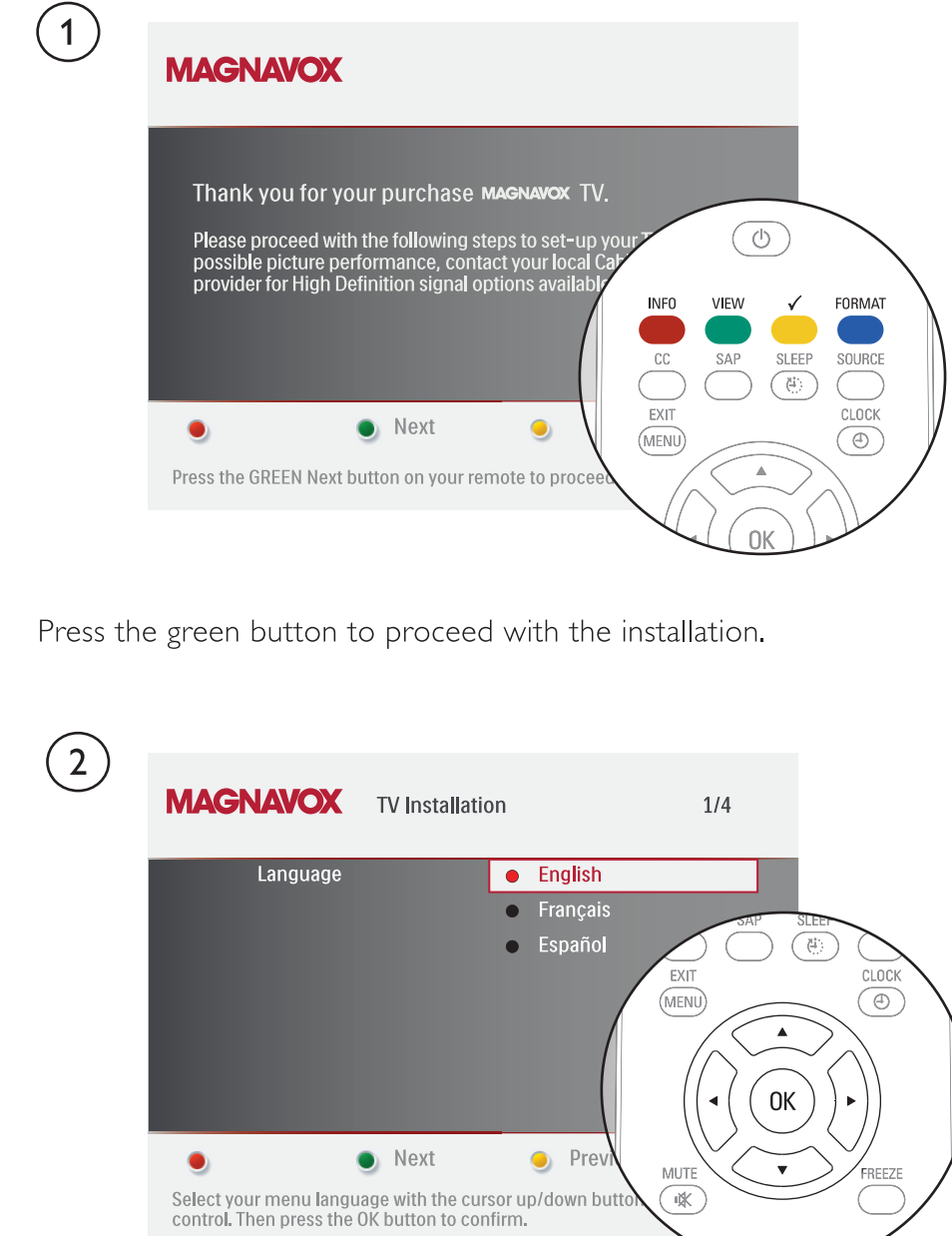

Press the green button to proceed with the installation.

The complete User Manual is available at www.magnavox.com/usasupport.

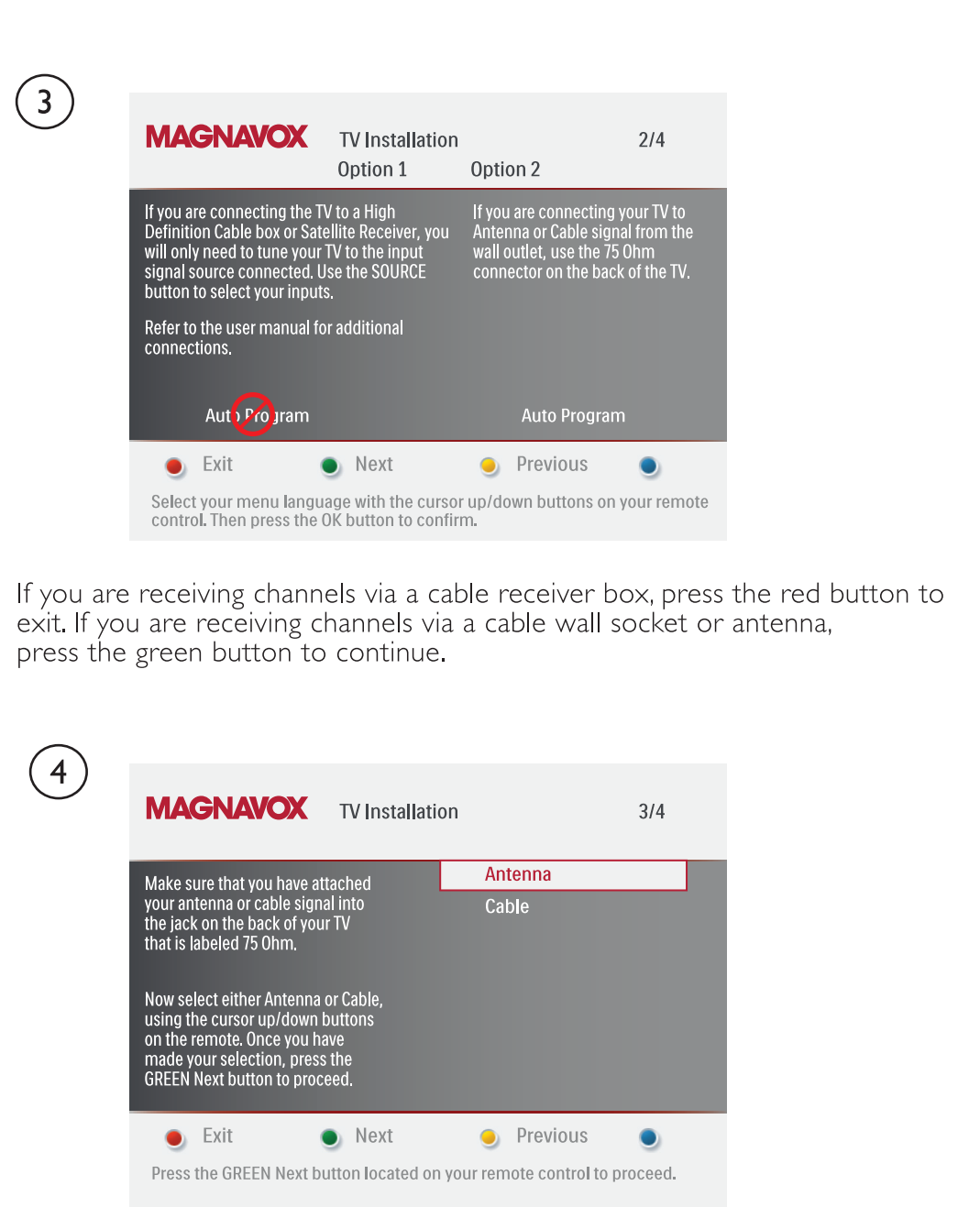

Select Antenna or Cable and press the green button to complete the installation.

The complete User Manual is available at www.magnavox.com/usasupport.

Remote control

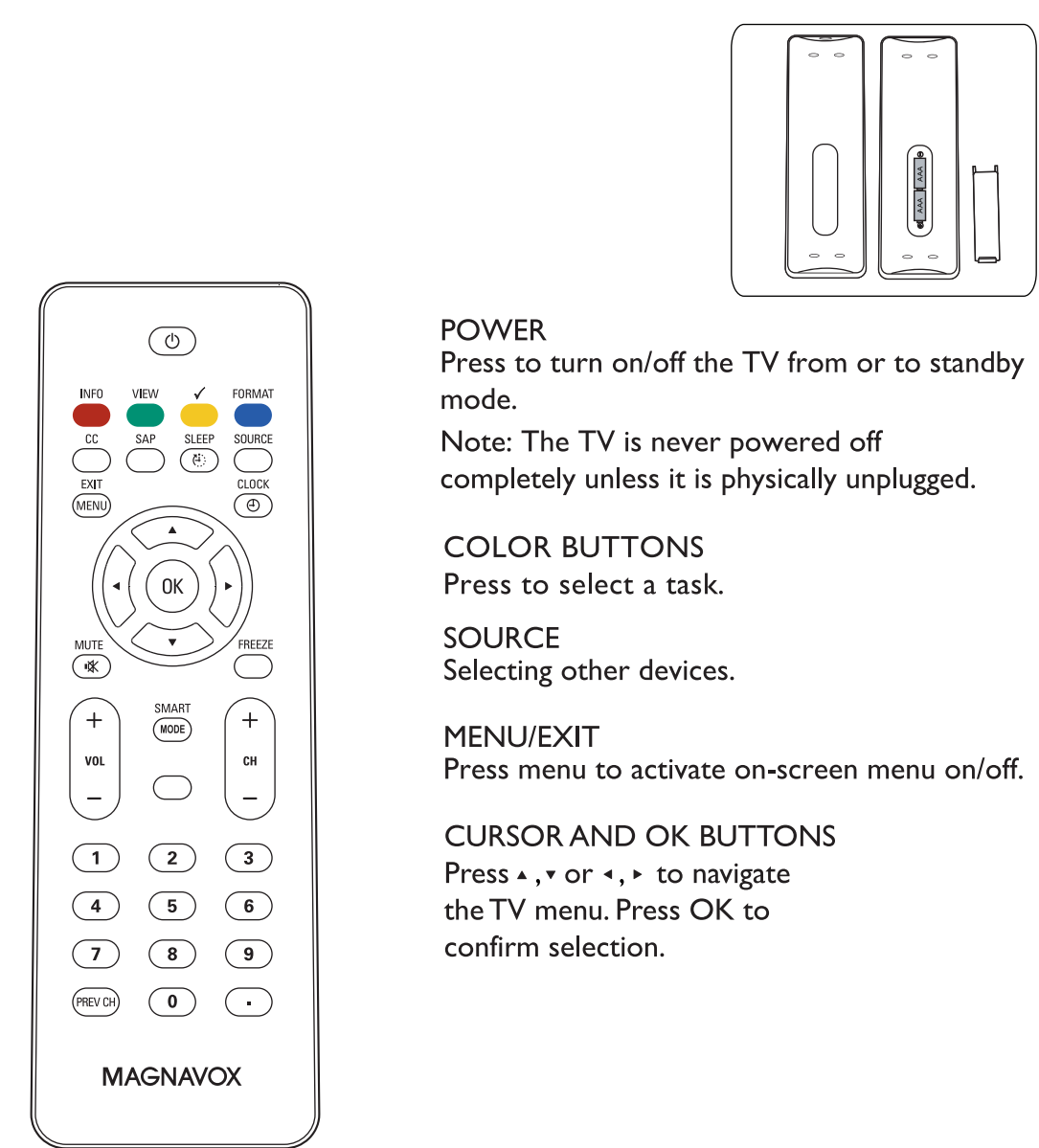

Press POWER button to switch on TV after connecting AC power cord.

The complete User Manual is available at www.magnavox.com/usasupport.

Connect the AC power cord and antenna

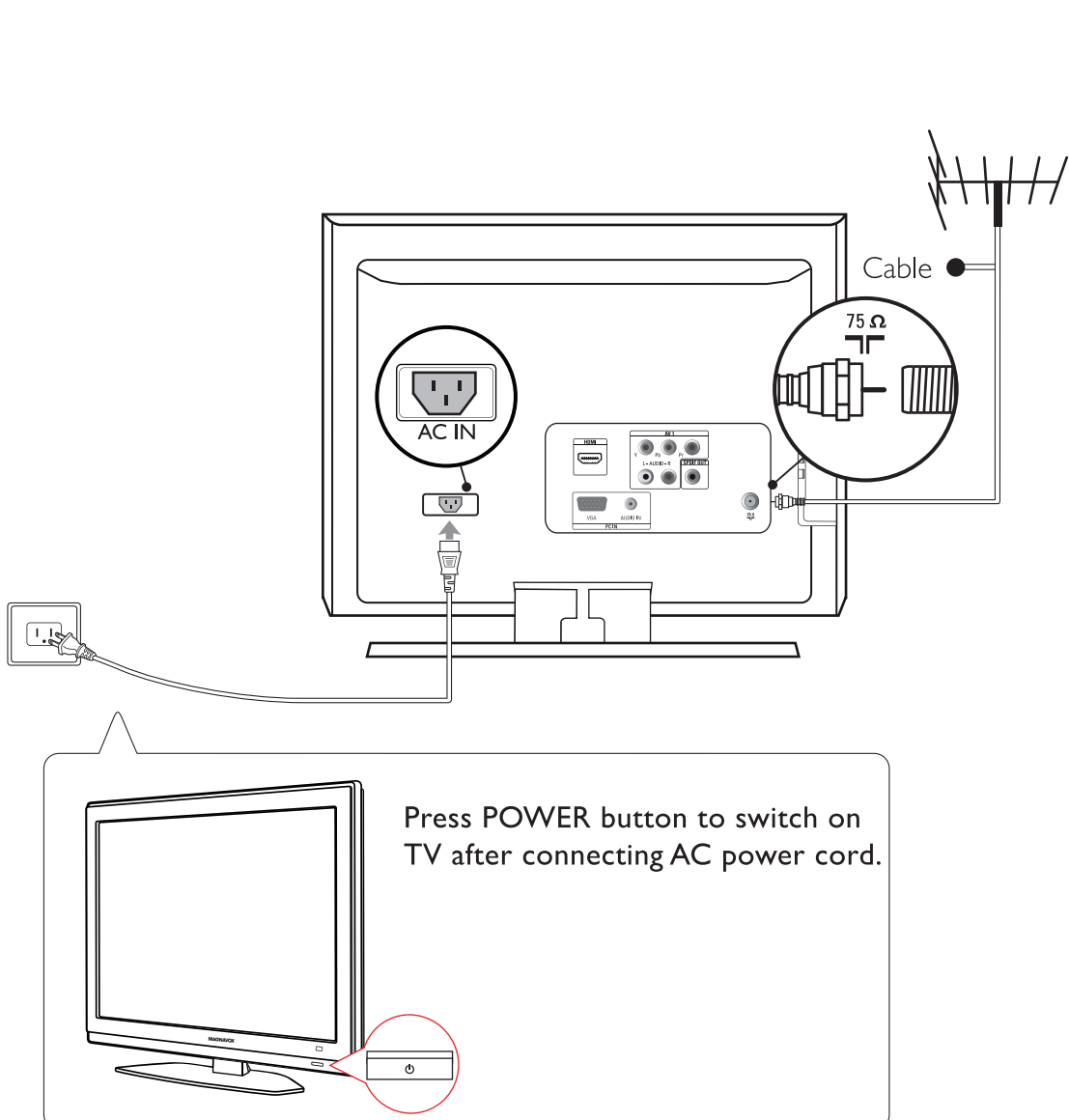

The complete User Manual is available at www.magnavox.com/usasupport.

Connect to PC

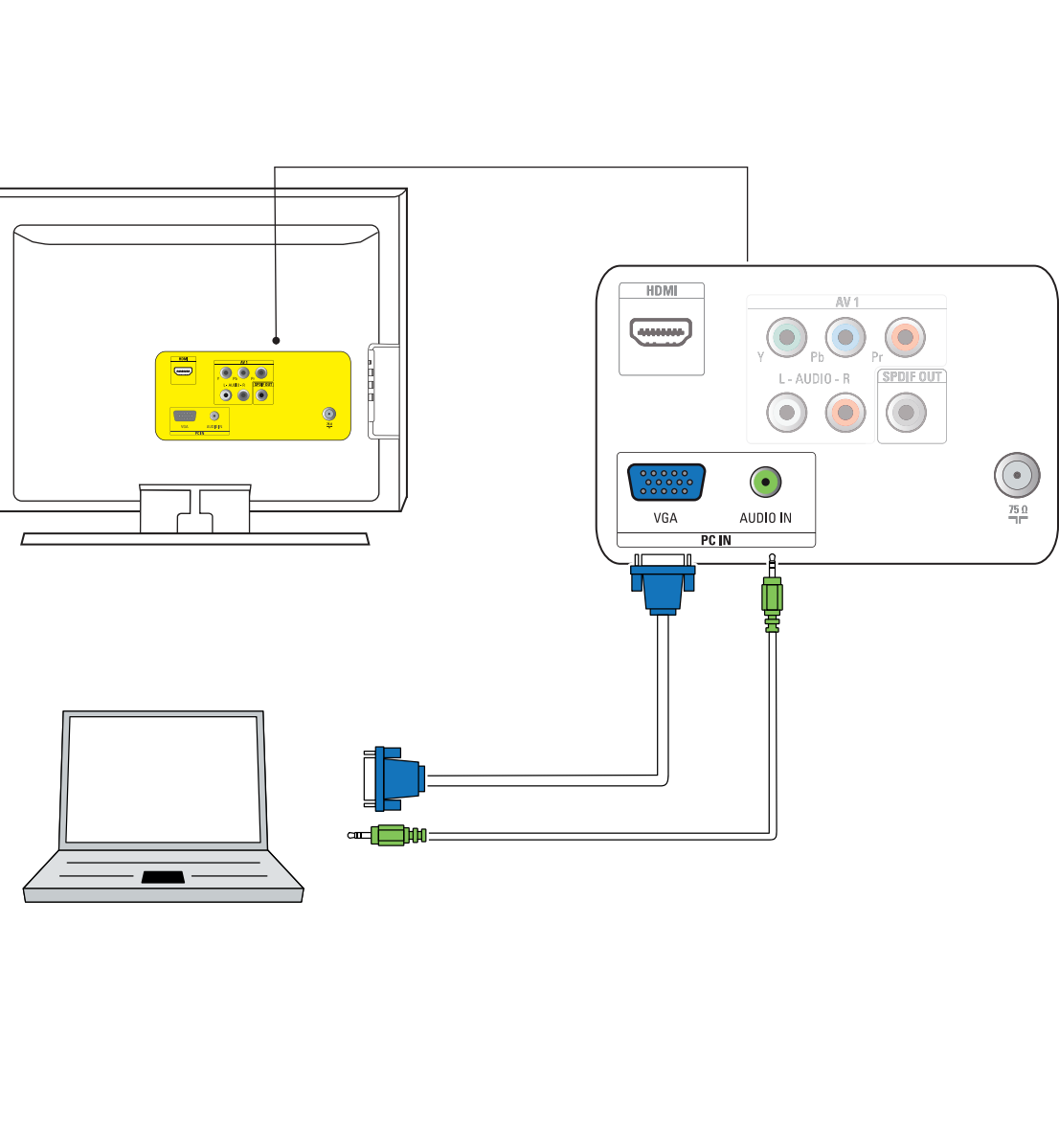

The complete User Manual is available at www.magnavox.com/usasupport.

Warranty

NINETY (90) DAY LABOR / ONE (1) PARTS

WARRANTY COVERAGE: MAGNAVOX warranty obligation is limited to the terms set forth below.

WHO IS COVERED: Magnavox warrants the product to the original purchaser or the person receiving the product as a gift against defects in materials and workmanship as based on the date of original purchase ("Warranty Period") from an Authorized Dealer. The original sales receipt showing the product name and the purchase date from an authorized retailer is considered such proof.

WHAT IS COVERED: The Magnavox warranty covers new products if a defect in material or workmanship occurs and a valid claim is received by Magnavox within the Warranty Period. At its option, Magnavox will either (1) repair the product at no charge, using new or refurbished replacement parts; or (2) exchange the product with a product that is new or which has been manufactured from new, or serviceable used parts and is at least functionally equivalent or most comparable to the original product in Magnavox current inventory; or (3) refund the original purchase price of the product.

Magnavox warrants replacement products or parts provided under this warranty against defects in materials and workmanship from the date of the replacement or repair for ninety (90) days or for the remaining portion of the original product's warranty, whichever provides longer coverage for you. When a product or part is exchanged, any replacement item becomes your property and the replaced item becomes Magnavox property. When a refund is given, your product becomes Magnavox property.

Note: Any product sold and identified as refurbished or renewed carries a ninety (90) day limited warranty.

Replacement product can only be sent if all warranty requirements are met. Failure to follow all warranty requirements can result in delay.

WHAT IS NOT COVERED - EXCLUSIONS AND LIMITATIONS: This Limited Warranty applies only to the new products manufactured by or for Magnavox that can be identified by the trademark, trade name, or logo affixed to it. This Limited Warranty does not apply to any non-Magnavox hardware product or any software, even if packaged or sold with the product. Non-Magnavox manufacturers, suppliers, or publishers may provide a separate warranty for their own products packaged with the bundled product.

Magnavox is not liable for any damage to or loss of any programs, data, or other information stored on any media contained within the product, or any non-Magnavox product or part not covered by this warranty. Recovery or reinstatement of programs, data or other information is not covered under this Limited Warranty.

This warranty does not apply (a) to damage caused by accident, abuse, misuse, neglect, misapplication, or non-Magnavox product, (b) to damage caused by service performed by anyone other than Magnavox or Magnavox Authorized Service Location.

This warranty gives you specific legal rights. You may have other rights which vary from state/province to state/province.

Magnavox, P.O. Box 671539, Marietta, Ga. 30066-0026 (312) 233-4893

Trouble shooting

Symptoms	Possible cause	What should you do
No power or indicator light.	The TV is not connected to the power.	1. Press POWER at the front of the TV, or press θ on the remote control. 2. Ensure the AC power cord is connected tightly to the TV power connector and to the power socket outlet. 3. Remove the AC power cord from the power socket outlet, wait 60 seconds and reconnect the AC power cord. 4. Connect the TV to a different power socket outlet.
Error message on the screen with HDMI connection.	HDCP authentication fail.	1. Ensure that your HDMI cable is certified. 2. Press SOURCE on the remote control to switch to another source and then switch back to the HDMI source. 3. Reset the accessory device and the TV. 4. While the TV and the accessory device are powered on, unplug either end of the HDMI cable and then reinsert the cable.
No sound is detected from the PC.	Audio cable is not connected.	1. Connect an audio cable to the PC AUDIO IN port on the TV. 2. Press SOURCE on the remote control, and select the PC source.
TV does not respond to the remote control.	Batteries are installed incorrectly, or low battery power.	1. Ensure the indicator light on the TV blinks when the remote control buttons are pressed. 2. Ensure that you are using the remote control supplied with the TV. 3. Ensure that the batteries of the remote control are inserted according to the illustration on the remote control and that the batteries do not need to be replaced. 4. Remove the AC power cord from the power socket outlet, wait 60 seconds and reconnect the AC power cord.
The picture is distorted. It is stretched out, has short, fat, black bars on the side or top.	Broadcast video format.	1. Press the FORMAT button on the remote control to select the best picture format. 2. For some accessory devices, the picture format has to be set in the accessory device.
The picture is moody red and green, or the picture is missing red when the TV is connected to an accessory device via component cables.	Insecure/incorrect connection.	1. Ensure all the connections are made according to the color code. 2. Push the component cables all the way into the YPbPr sockets on the TV.
No sound on the TV loudspeaker.	Volume level is set to zero. Sound is muted.	1. Increase the volume. 2. Press MUTE on the remote control.
Headphones are connected.	Headphones are connected.	3. Ensure the headphones are not plugged into the TV.
Accessory device audio output setting is incorrect.	Accessory device audio output setting is incorrect.	4. For AV connection, ensure that the Audio L/R cable is connected as described in Connect device on page 28. If you are using a component cable, ensure that you have not crossed the red audio cable with the red video cable. 5. For HDMI connections, some accessory devices have an HDMI audio output setting that must be turned on for HDMI to HDMI connections.
Bad picture quality with a coaxial connection.	Standard definition channels are not as clear as high definition channels.	1. Connect the devices via component or HDMI cables.
No picture or sound.	Incorrect channel. Incomplete channel installation.	1. Ensure you have selected the correct channel. 2. If the TV receives channels via an AV connection, set the TV to the correct source input. 3. If the TV is connected directly to the wall via a coaxial connection, perform the auto-installation again.

Specification

Model no.	19MF338B
Aspect Ratio	16:9
Resolution	1440x900p
Brightness	300 cd/m2 (typ.)
Response Time (on/off)	5ms (typ.)
Viewing Angles (V/H)	160 by 160 (typ.)
Sound output (RMS Watts)	3 W x 2
Sound modes	Mono, Stereo, Virtual surround
EASE OF USE	
Video formats	Automatic, 4:3, Movie Expand 14:9, Movie Expand 16:9, Super Zoom, 16:9 subtitle, Wide Screen.
Smart modes	Personal, Sports, Standard, Movie, Power saver
CONNECTIONS	
Rear connectors	AV1: Component video input with Audio L/R (support 480p, 720p, 1080i) HDMI (Ver 1.3a HDMI support 480p, 720p, 1080i) SPDIF output (Digital audio out, support AC-3 & PCM) PC IN: VGA, PC Audio IN
Side connectors	Headphone x 1 Composite video input with audio L/R (support 480i)
WEIGHT & DIMENSIONS	
Gross weight	13.4 lbs
Net weight	11.4 lbs
Box dimension (LxWxH)	20.3" x 17.3" x 6.1"
Product dimension (HxWxD)	15.1" x 18.3" x 6.6"
POWER	
Power consumption	50W
Standby power consumption	<1W
Mains Power	100-120 V/60HZ
Specifications are subject to change without notice	

Wall Mount

When installing the LCDTV on the wall, please consult a professional technician for proper installation. The manufacturer accepts no liability for installations not performed by professional technician.

VESA standard (100 x 100mm)

Metric 4 (10mm) screws are needed for wall mounting (not included).

19MF338B

The complete User Manual is available at www.magnavox.com/usasupport.

Free Manuals Download Website

<http://myh66.com>

<http://usermanuals.us>

<http://www.somanuals.com>

<http://www.4manuals.cc>

<http://www.manual-lib.com>

<http://www.404manual.com>

<http://www.luxmanual.com>

<http://aubethermostatmanual.com>

Golf course search by state

<http://golfingnear.com>

Email search by domain

<http://emailbydomain.com>

Auto manuals search

<http://auto.somanuals.com>

TV manuals search

<http://tv.somanuals.com>