

MAGNAVOX

AZ 9055 Portable Micro System



Toll Free Help Line

Ligne d'assistance en service libre
Línea de ayuda telefónica sin cargo

800-531-0039



English page 4

English

Français page 17

Français

Español página 30

Español

**CLASS 1
LASER PRODUCT**

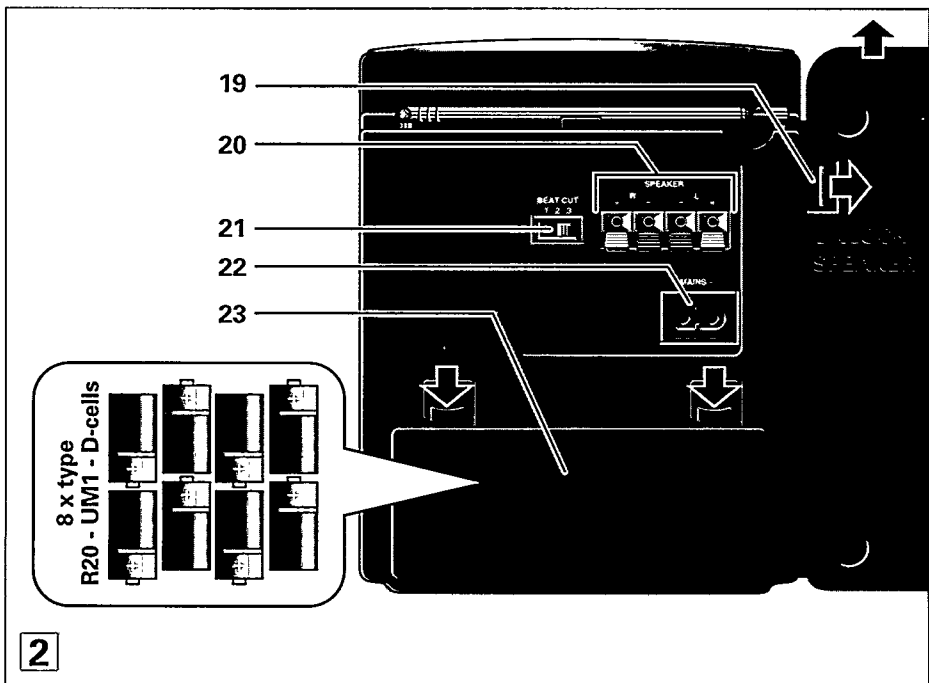
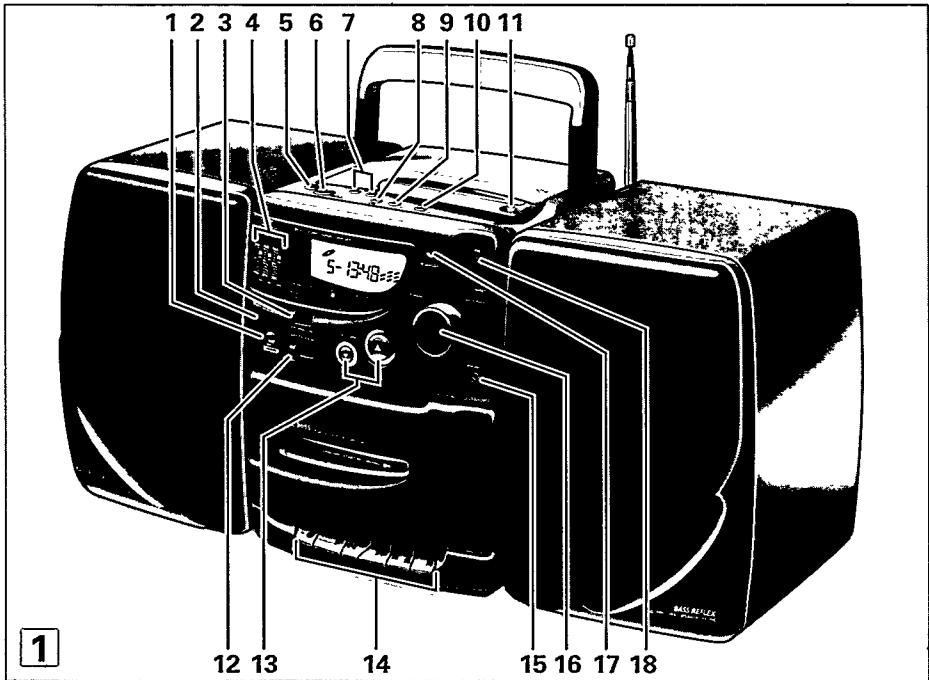

SAFETY

WARNING

To reduce the risk of fire or electric shock, do not expose this appliance to rain or moisture.

CAUTION

Use of controls or adjustments or performance of procedures other than herein may result in hazardous radiation exposure.

Canada

This digital apparatus does not exceed the Class B limits for radio noise emissions from digital apparatus as set out in the Radio Interference Regulations of the Canadian Department of Communications.

The set complies with the FCC-Rules, Part 15 and with 21 CFR 1010.10 and 1010.11.

SAFETY INSTRUCTIONS

Read before operating equipment

This product was designed and manufactured to meet strict quality and safety standards. There are, however, some installation and operation precautions which you should be particularly aware of.

- 1. Read Instructions** - All the safety and operating instructions should be read before the appliance is operated.
- 2. Retain Instructions** - The safety and operating instructions should be retained for future reference.
- 3. Heed Warnings** - All warnings on the appliance and in the operating instructions should be adhered to.
- 4. Follow Instructions** - All operating and use instructions should be followed.
- 5. Water and Moisture** - The appliance should not be used near water - for example, near a bathtub, washbowl, kitchen sink, laundry tub, in a wet basement or near a swimming pool, etc.
- 6. Carts and Stands** - The appliance should be used only with a cart or stand that is recommended by the manufacturer.
- 6A.**  An appliance and cart combination should be moved with care. Quick stops, excessive force, and uneven surfaces may cause the appliance and cart combination to overturn.
- 7. Wall or Ceiling Mounting** - The appliance should be mounted to a wall or ceiling only as recommended by the manufacturer.
- 8. Ventilation** - The appliance should be situated so that its location or position does not interfere with its proper ventilation. For example, the appliance should not be situated on a bed, sofa, rug, or similar surface that may block the ventilation openings; or, placed in a built-in installation, such as a bookcase or cabinet that may impede the flow of air through the ventilation openings.
- 9. Heat** - The appliance should be situated away from heat sources such as radiators, heat registers, stoves, or other appliances (including amplifiers) that produce heat.
- 10. Power Sources** - The appliance should be connected to a power supply only of the type described in the operating instructions or as marked on the appliance.

11. Grounding or Polarization

The precautions that should be taken so that the grounding or polarization means of an appliance is not defeated.

Caution: To prevent electric shock, match the wide blade of this plug to the wide slot, fully insert. Do not use this (polarized) plug with an extension cord, receptacle or other outlet unless the blades can be fully inserted to prevent blade exposure.

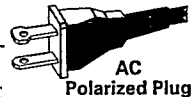

- 12. Power-Cord Protection** - Power supply cords should be routed so that they are not likely to be walked on or pinched by items placed upon or against them, paying particular attention to cords and plugs, convenience receptacles, and the point where they exit from the appliance.
- 13. Cleaning** - The appliance should be cleaned only as recommended by the manufacturer.
- 14. Power Lines** - An outdoor antenna should be located away from power lines.
- 15. Nonuse Periods** - The power cord of the appliance should be unplugged from the outlet when left unused for a long period of time.
- 16. Object and Liquid Entry** - Care should be taken so that objects do not fall and liquids are not spilled into the enclosure through openings.
- 17. Damage Requiring Service** - The appliance should be serviced by qualified service personnel when:
 - A.** The power-supply cord or the plug has been damaged; or
 - B.** Objects have fallen, or liquid has spilled into the appliance; or
 - C.** The appliance has been exposed to rain; or
 - D.** The appliance does not appear to operate normally or exhibits a marked change in performance; or
 - E.** The appliance has been dropped, or the enclosure damaged.
- 18. Servicing** - The user should not attempt to service the appliance beyond that described in the operating instructions. All other servicing should be referred to qualified service personnel.

MAGNAVOX

Smart.Very smart.™

WARRANTY REGISTRATION CARD

Return your Warranty Registration Card today to ensure you receive all the benefits you're entitled

Once your MAGNAVOX purchase is registered, you're eligible to receive all the privileges of owning a MAGNAVOX product. So complete and return the Warranty Registration Card enclosed with your purchase at once. And take advantage of these important benefits.

■ Warranty Verification

Registering your product within 10 days confirms your right to maximum protection under the terms and conditions of your MAGNAVOX warranty.

■ Owner Confirmation

Your completed Warranty Registration Card serves as verification of ownership in the event of product theft or loss.

■ Model Registration

Returning your Warranty Registration Card right away guarantees you'll receive all the information and special offers which you qualify for as the owner of your model.

MAGNAVOX

Smart.Very smart.™

HURRY!
Registration
Needed
Within
10 Days

Congratulations on your purchase, and welcome to the 'family'!

Dear MAGNAVOX product owner

Thank you for your confidence in MAGNAVOX. You've selected one of the best-built, best-backed products available today. And we'll do everything in our power to keep you happy with your purchase for many years to come.

As a member of the MAGNAVOX 'family', you're entitled to protection by one of the most comprehensive warranties and outstanding service networks in the industry.

What's more, your purchase guarantees you'll receive all the information and special offers for which you qualify, plus easy access to accessories from our convenient home shopping network.

And most importantly you can count on our uncompromising commitment to your total satisfaction.

All of this is our way of saying welcome and thanks for investing in a MAGNAVOX product.

Sincerely,

Robert Minkhorst
President and Chief Executive Officer

P.S. Remember, to get the most from your MAGNAVOX product, you must return your Warranty Registration Card within 10 days. So please mail it to us right now!

Know these safety symbols

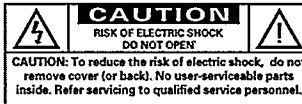

⚡ This 'bolt of lightning' indicates uninsulated material within your unit may cause an electrical shock. For the safety of everyone in your household, please do not remove product covering.

⚠ The 'exclamation point' calls attention to features for which you should read the enclosed literature closely to prevent operating and maintenance problems.

WARNING: To prevent fire or shock hazard, do not expose this equipment to rain or moisture.

CAUTION: To prevent electric shock, match wide blade of plug to wide slot, and fully insert.

For Customer Use

Enter below the Serial No. which is located on the rear of the cabinet. Retain this information for future reference.

Model No. _____

Serial No. _____

LIMITED WARRANTY

English

MAGNAVOX PORTABLE COMPACT DISC One Year Free Exchange This product must be carried in for an exchange

WHO IS COVERED?

You must have proof of purchase to exchange the product. A sales receipt or other document showing that you purchased the product is considered proof of purchase. Attach it to this owner's manual and keep both nearby.

WHAT IS COVERED?

Warranty coverage begins the day you buy your product. *For one year thereafter*, a defective or inoperative product will be replaced with a new, renewed or comparable product at no charge to you. A replacement product is covered only for the original warranty period. When the warranty on the original product expires, the warranty on the replacement product also expires.

WHAT IS EXCLUDED?

Your warranty does not cover:

- labor charges for installation or setup of the product, adjustment of customer controls on the product, and installation or repair of antenna systems outside of the product.
- product repair and/or part replacement because of misuse, accident, unauthorized repair or other cause not within the control of Philips Consumer Electronics Company.
- reception problems caused by signal conditions or cable or antenna systems outside the unit.
- a product that requires modification or adaptation to enable it to operate in any country other than the country for which it was designed, manufactured, approved and/or authorized, or repair of products damaged by these modifications.
- incidental or consequential damages resulting from the product. (Some states do not allow the exclusion of incidental or consequential damages, so the above exclusion may not apply to you. This includes, but is not limited to, prerecorded material, whether copyrighted or not copyrighted.)

WHERE IS EXCHANGE AVAILABLE?

You may exchange the product in all countries where the product is officially distributed by Philips Consumer Electronics Company. In countries where Philips Consumer Electronics Company does not distribute the product, the local Philips service organization will attempt to provide a replacement product (although there may be a delay if the appropriate product not readily available).

BEFORE REQUESTING EXCHANGE

Please check your owner's manual before requesting an exchange. Adjustments of the controls discussed there may save you a trip.

EXCHANGING A PRODUCT IN U.S.A., PUERTO RICO OR U.S. VIRGIN ISLANDS

Contact your dealer to arrange an exchange. Or, ship the product, insured and freight prepaid, and with proof of purchase enclosed, to the address listed below.

Small Product Service Center

Philips Service Company
907 Snapps Ferry Road, Plant 2, Building 6
Greenville, TN 37743

(In U.S.A., Puerto Rico and U.S. Virgin Islands, all implied warranties, including implied warranties of merchantability and fitness for a particular purpose, are limited in duration to the duration of this express warranty. But, because some states do not allow limitations on how long an implied warranty may last, this limitation may not apply to you.)

EXCHANGING A PRODUCT IN CANADA

Contact your dealer to arrange an exchange. Or, ship the product, insured and freight prepaid, and with proof of purchase enclosed, to one of the Philips consumer service centers listed below.

Philips Electronics Ltd.

601 Milner Avenue, Scarborough,
Ontario, M1B 1M8 - ☎ (416) 292-5161
4977 Levy Street, St. Laurent, (Montréal),
Québec, H4R 2N9 - ☎ (514) 956-0120
3695 Grandview Highway, Vancouver,
B.C., V5M 2G7 - ☎ (604) 435-4411

(In Canada, this warranty is given in lieu of all other warranties. No other warranties are expressed or implied, including any implied warranties of merchantability or fitness for a particular purpose. Philips is not liable under any circumstances for any direct, indirect, special, incidental or consequential damages, howsoever incurred, even if notified of the possibility of such damages.)

TO GET OUT-OF-WARRANTY EXCHANGE

In U.S.A., Puerto Rico or U.S. Virgin Islands, contact Philips Service Company at ☎ (800) 851-8885 to obtain the cost of out-of-warranty exchange. Then carefully pack the product and ship it to the Small Product Service Center (address listed above).

In Canada, contact the nearest Philips consumer service center (phone number and address listed above) to obtain the cost of out-of-warranty exchange. Then carefully pack the product and ship it to that service center.

REMEMBER

Please record the model and serial numbers found on the product below. Also, please fill out and mail your warranty registration card promptly. It will be easier for us to notify you if necessary.

Model # _____

Serial # _____

*This warranty gives you specific legal rights.
You may have other rights which vary from state to state.*

Philips Service Company
401 East Andrew Johnson Highway
Jefferson City, Tennessee 37760
☎ (615) 475-8869

EL4967E001 / MAC 4103 / 12-94

1. GENERAL

2. PRECAUTIONS

CONTENTS

1. GENERAL	7
2. PRECAUTIONS	7
3. INSTALLATION	8
4. CONTROLS	9
5. OPERATION.....	10
6. RADIO	10
7. CD PLAYER	11-13
8. CASSETTE RECORDER	14
9. MAINTENANCE	15
10. TROUBLESHOOTING	16

RECYCLING

Please observe the local regulations regarding the disposal of packing materials, exhausted batteries and old equipment.

- All redundant packaging material has been omitted. We have done our utmost to make the packaging easy separable into three mono-materials:
 - cardboard (box)
 - expandable polystyrene (buffer)
 - polyethylene (bags, protective foam sheet)
- Your set consists of materials which can be recycled if disassembled by a specialized company.
- Do not dispose of exhausted batteries with your household waste.

PRECAUTIONS

- Place the system on a hard and flat surface so that it does not tilt.
- Before replacing or removing the batteries, always switch off the unit first and wait until the CD display goes out.
- The amplifier produces heat which must dissipate freely, so do not cover any ventilation slots and make sure that there is sufficient ventilation around the system. A minimum gap of 15 cm is necessary.
- Do not cover the system.

3. INSTALLATION - see fig. 2 on page 3

English

POWER SUPPLY

Battery supply

Whenever convenient, use the power supply if you want to conserve battery life.

- Open the battery compartment and insert as shown eight batteries, type R20, UM1 or D-cells.
- Remove the batteries if exhausted or if they will not be used again for a long period.

The battery supply is switched off when the set is connected to the power. To change over to battery supply, pull out the plug from the POWER outlet (MAINS ~).

AC power supply

- Check if the power voltage as shown on the type plate (on the bottom of the set) corresponds to your local power voltage. If it does not, consult your dealer or service organisation.
- Connect the power cord to the POWER outlet (MAINS ~) and the wall outlet.

When connected to the power, the system is always energised. To switch off the AC power supply completely, pull the power plug out of the wall outlet.

The type plate can be found on the bottom of the set.

Recording is permissible insofar as copyright or other rights of third parties are not infringed.

Warning

Invisible laser radiation when open and interlocks defeated. Avoid exposure to beam.

REMOVABLE SPEAKERS

Taking off the speakers

- Keep the UNLOCK lever pressed and slide the speaker upwards, see fig. 2.

Attaching the speakers

- Slide the speakers from above in the sleeves on the sides of the set cabinet. The speakers will click into position.

POSITIONING THE SPEAKERS

You will find the best speaker position by experimenting. Placing the speakers on the floor will increase the bass response. Placing the speakers behind curtains, furniture etc. will reduce the treble response and the stereo effect. The ideal position is obtained when the 2 front speakers and the listening position build an equilateral triangle and the speakers are at ear-height.

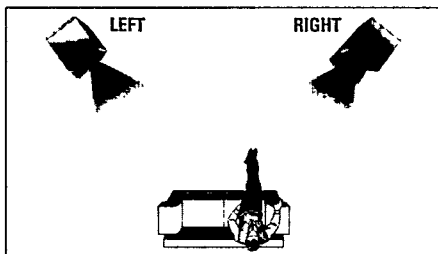

CONNECTING THE SPEAKERS

- Connect the 2 supplied speakers with the black or non-marked wires to the black terminals ⊖ and the red or marked wires to the red terminals ⊕.

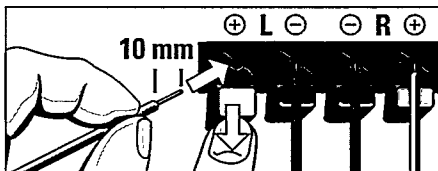

4. CONTROLS - see figs. 1 - 2 on page 3

TOP AND FRONT PANEL

- 1 **POWER on/stand by button**
- 2 **STAND BY indicator**
- 3 **AM-FM-FMST (stereo) - wave band selector**
- 4 **GRAPHIC EQUALIZER - tone controls:**
 - 100 Hz - bass
 - 1 kHz - mid
 - 10 kHz - treble
- 5 **STOP ■ - CD stop**
- 6 **PLAY-PAUSE ►|| - CD play and pause**
- 7 **◀◀ PREVIOUS/NEXT ▶▶ / SEARCH**
 - to search for a particular passage within a CD track
 - to return to the start of a CD track or to select a next or previous track
- 8 **SHUFFLE -** to play an entire CD in a random order
- 9 **REPEAT -** to repeat one track, an entire CD or a CD program
- 10 **PROGRAM -** to program CD track numbers
- 11 **OPEN-CLOSE -** to open and close the CD door.
- 12 **CD/TAPE/RADIO -** function selector
- 13 **VOLUME ▲/▼ -** to adjust the volume
- 14 **Cassette buttons**
 - RECORD ●**
 - PLAY ►**
 - REWIND ◀◀ -** fast rewind
 - F.FWD ▶▶ -** fast forward wind
 - STOP-EJECT ■ ▲**
 - PAUSE ||**
- 15 **PHONES Ⓜ -** socket for stereo headphones having a 3.5 mm plug. Inserting the plug will disconnect the speakers.
- 16 **TUNING knob -** to tune to radio stations
- 17 **REMOTE SENSOR -** receives the infrared remote control signals
- 18 **FM STEREO -** FM stereo indicator - lights up when receiving an FM stereo station

BACK PANEL

- 19 **UNLOCK -** levers to take off the speakers
- 20 **SPEAKERS -** speaker terminals
- 21 **BEAT CUT -** If during recording of an AM radio station, a whistling sound is heard, this can be suppressed by setting the BEATCUT switch to another position.
- 22 **MAINS ~ -** socket for power cord
- 23 **BATTERY DRAWER**

REMOTE CONTROL

- 24 **POWER on/stand by button**
- 25 **VOLUME ▲/▼ -** to adjust the volume
- 26 **PLAY-PAUSE ►|| -** to start or interrupt CD-playback
- 27 **STOP ■ -** to stop CD-playback
- 28 **◀◀ PREVIOUS/NEXT ▶▶ / SEARCH**
 - to search for a particular passage within a track
 - to return to the start of a track or to select a next or previous track

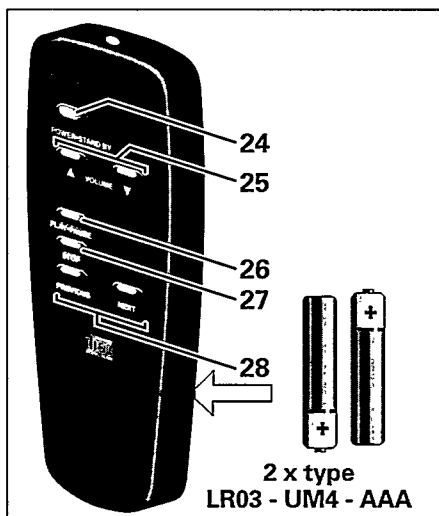

Remote control batteries

- Open the battery compartment and insert two batteries, type LR03, UM4 or AAA.
- Remove the batteries when they are exhausted or if they will not be used again for a long period.

5. OPERATION

6. RADIO

English

GENERAL OPERATION OF THE SYSTEM

- To switch on the system, press the POWER button on the system or on the remote control (when in AC operation).
- To select the sound source, use the CD/TAPE/RADIO selector .
- Adjust the sound using the VOLUME ▲/▼ buttons.
 - If headphones are connected, the speakers are switched off.
- Adjust the tone using the GRAPHIC EQUALIZER controls:
 - 100 Hz - bass
 - 1 kHz - mid
 - 10 kHz - treble
- To switch off the system, press the POWER button on the system or on the remote control
 - When in AC operation the STAND BY indicator lights up
- In battery operation;
 - the POWER on/stand by button on the remote control can only be used to switch off the system.
 - The system can be switched on by pressing the POWER on/stand by button on the system.
 - Back light for display and the STAND BY indicator will not light up to save battery power.

RADIO RECEPTION

- Set the CD/TAPE/RADIO selector to RADIO.
- Adjust the sound using the VOLUME ▲/▼ buttons and the GRAPHIC EQUALIZER tone controls.
- Select the wave band using the selector AM/FM/FMST.
- Tune to a radio station using the TUNING knob.
 - For FM, pull out the telescopic aerial. To improve FM-reception, incline and turn the aerial. Reduce its length if the FM-signal is too strong (very close to a transmitter).
 - For AM, the set is provided with a built-in aerial, so the telescopic aerial is not needed. Direct the aerial by turning the whole set.
- When the FM stereo indicator lights up, you are receiving a FM-stereo transmitter. A disturbing noise, due to a weak FM-stereo signal, can be suppressed by setting the selector AM/FM/FM ST to position FM (mono). The FM STEREO indicator goes out and you will hear (and record) the FM station in mono.

7. CD PLAYER

CD HANDLING

- Use only Digital Audio CDs.
- To take the CD out of its box easily, press the centre spindle while lifting the CD.

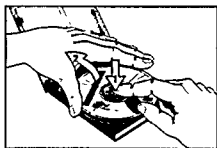

- Never write on a CD or attach any sticker to the CD.
- Always hold the CD at the edge and always store it in its box after use, label facing up.
- To remove dust and dirt breathe on the CD and wipe it with a soft, lint-free cloth in a straight line from the centre towards the edge. Cleaning agents may damage the CD.
- Do not expose the CD to rain, moisture, sand, or to excessive heat e.g. from heating equipment or in motor cars parked in the sun.



CD-DISPLAY

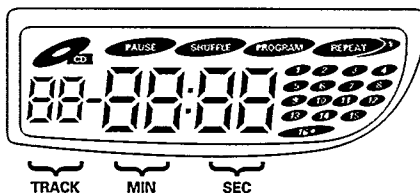

English

TRACK - shows:

In the STOP position;

- No segment when no disc is inside the CD compartment
- The total number of tracks on the CD or the track number of a program when a disc is inside the CD compartment.

In the PLAY position;

- The track number that is playing

MIN / SEC - shows:

In the STOP position;

- No segment when no disc is inside the CD compartment
- The total playing time of the CD or the program number when a disc is inside the CD compartment

In the PLAY position;

- The elapsed playing time of the running track.



the CD function is selected.



shows that PAUSE is activated.



shows that SHUFFLE is activated.



shows that a CD PROGRAM is being played, stored or proceeding.



REPEAT shows that the entire CD or the CD selection (PROGRAM) is being repeated.



REPEAT 1 shows that one CD track is being repeated.



MUSIC CALENDER

With disc inside CD compartment





1. In position STOP, it shows how many tracks are present on the CD. '16+' means more than 16 tracks.
2. In position PROGRAM, it shows which tracks have been programmed.
3. During PLAY, it shows which tracks are still waiting to be played.

Without disc inside CD compartment

1. Display shows all track numbers including '16+'.

7. CD PLAYER

PLAYING A CD

- Set the CD/TAPE/RADIO selector to CD.
-  appears.
- Press OPEN-CLOSE to open the CD door.
- Insert the AUDIO CD, printed side facing up.
- Close the CD door.  The CD-player scans the contents list of the CD. After that, the total playing time and the number of tracks appear on the display and the CD-player stops. If there are more than 16 tracks on the CD, '16+' will light up.
- Adjust the sound using the VOLUME ▲/▼ buttons and the GRAPHIC EQUALIZER tone controls.
- Playback will start by pressing PLAY-PAUSE ►||.
- The display shows the track number and the elapsed playing time. The track being played will flash in the music calendar.
- For brief interruptions, press PLAY-PAUSE ►||.
-  appears
- To continue playback, press PLAY-PAUSE ►|| again.
-  disappears
- To stop playback, press STOP ■.
- The CD player also goes to position STOP:
 - by pressing POWER;
 - by pressing OPEN-CLOSE;
 - when the end of the CD is reached;
 - if you change the function selection;
 - if the batteries are exhausted or if the power supply is interrupted.
- To take out the CD, open the CD door by pressing OPEN-CLOSE. Open the CD door only if the CD-player is in position STOP.

◀◀ PREVIOUS/NEXT ▶▶ / SEARCH

Selecting another track

By pressing *briefly* the SEARCH ◀◀ or ▶▶ button, you can jump to a next or previous track, or you can select a track before starting playback in STOP position.

a. During PLAY

▶▶ - go to the next track (title)

You can jump to the next track by pressing ▶▶ once.

If you want to skip more than one track, press ▶▶ more than once until the display shows the desired track number.

◀◀ - go to the previous track (title)

If you want to repeat the running track from the beginning, press ◀◀ once.

If you want to repeat one of the previous tracks, press ◀◀ more than once until the display shows the required track number.

b. In position STOP

In position STOP with a CD inserted you can select the desired track using SEARCH ◀◀ or ▶▶ until the display shows the required track number.

Press PLAY-PAUSE ►|| to start playback.

Searching a passage within a track



You can search for a passage within a track. The CD is played partly and at high speed, however, the sound is still recognizable.

- *During playback, keep* the button ◀◀ or ▶▶ *pressed*, and release the button as soon as you recognize the required passage: the CD will be played in the normal way from this passage.







7. CD PLAYER

SHUFFLE - PLAY IN RANDOM ORDER

The SHUFFLE-function plays all tracks of the CD in a random order.

- From the STOP-position, press SHUFFLE.
- The display shows , and all tracks are played in a random order after pressing PLAY · PAUSE .

During PLAY;

- If you press  briefly, one of the next () tracks (at random) is played.
- If you press  briefly, the already played track () is repeated
- Searching for a passage with /  can only be done within the track being played.
- To leave the SHUFFLE-mode, press SHUFFLE again or in STOP-position press STOP .

 disappears from the display.



REPEAT

It is possible to repeat the entire CD or CD-program or to repeat one particular track.

- Press REPEAT once or more than once until the desired option is displayed:

 REPEAT - to repeat the entire CD or CD-program continuously.









 REPEAT 1 - to repeat the displayed track continuously.
– no display indication - REPEAT is switched off.

- Press PLAY·PAUSE  to start playback.
- To stop playback, press .
- REPEAT option can also be changed during PLAY.

PROGRAMMING TRACK NUMBERS

You may store at most 20 tracks in the memory in the desired sequence. You may store any track more than once. When playing, you will only hear the stored tracks in the selected sequence.



Programming

- Press STOP  to stop playback.
- Press PROGRAM.
-  PROGRAM and program number P :  ! appear.
- Select the desired track using SEARCH  or  until the display shows the required track number.
- Store the desired track by pressing PROGRAM.
- The music calender in the display shows all programmed tracks.
- Select and store in this way for all desired tracks of a CD.
- If you try to store more than 20 tracks, the program sequence goes back to the first programmed track and P :  ! appears. The new programmed track will supersede the original stored track.
- To play the selection, press PLAY·PAUSE .
- Playback will start with the first programmed track of the program.
- When pressing STOP  and also when all tracks have been played, playback will stop.

Checking the program

- From the STOP-position, press PROGRAM again and again: the display shows in sequence all programmed track numbers.

Erasing a program

- You can erase the contents of the memory:
 - by pressing STOP  during programming.
 - in the STOP mode by pressing STOP  again;
 - in the PLAY mode by pressing STOP  twice;
 - by opening the CD door by pressing OPEN-CLOSE.

8. CASSETTE RECORDER

English

CASSETTE PLAYBACK

- Set the CD/TAPE/RADIO selector to TAPE.
- Press STOP-EJECT ■ ▲ to open the cassette holder.
- Insert a recorded cassette.
- For fast winding, press REWIND ◀◀ or F.FWD ▶▶.
- To stop, press STOP-EJECT ■ ▲.
- Press PLAY ▶ and playback will start.
- Adjust the sound using the VOLUME ▲/▼ buttons and the GRAPHIC EQUALIZER tone controls.
- For brief interruptions, press PAUSE II.
- To restart playback, press this button once more.
- To stop playback, press STOP-EJECT ■ ▲. On pressing again, the cassette holder will open.
- When the end of the tape is reached, the cassette buttons are released.

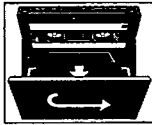

CASSETTE RECORDING

Preparation

- The recording level is set automatically.
- Press STOP-EJECT ■ ▲ to open the cassette holder.
- Insert the cassette with the full reel on the left-hand side.
- When monitoring during recording, adjust the sound using the VOLUME ▲/▼ buttons and the GRAPHIC EQUALIZER tone controls. These controls do not affect the recording.
- For fast winding, press REWIND ◀◀ or F.FWD ▶▶. To stop, press STOP-EJECT ■ ▲.
- When the end of the tape is reached, the cassette buttons are released.

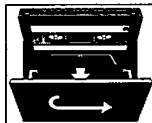

Starting and stopping the recording

- Start recording by pressing RECORD ●. The PLAY ▶ button is then automatically pressed too.
- For brief interruptions, press PAUSE II.
- To restart recording, press this button once more.
- To stop recording, press STOP-EJECT ■ ▲. On pressing again, the cassette holder will open.
- When the end of the tape is reached during recording, the recorder buttons are released.
- To record the other side of the cassette, turn it over by hand, rewind it to the beginning and press RECORD ●.

Recording from the radio

- Set the CD/TAPE/RADIO selector to RADIO.
- For FM recordings, select FM for mono recordings and FM ST for stereo recordings using the AM/FM/FM ST switch.
- If you hear a whistling sound during recording of an AM radio station, this can be suppressed by setting the BEAT CUT switch (on the back) to another position.

CD synchro - recording from the CD-player

- Set the CD/TAPE/RADIO selector to CD.
- It is not necessary to start the CD-player separately: by pressing RECORD ● the CD-player starts automatically:
 - if the CD-player is in position STOP, recording will start from the beginning of the CD (or the programmed selection);
 - if the CD-player is in position STOP and a certain track is selected using the ◀◀ ▶▶ buttons, recording will start from the beginning of that track.
 - to start a recording in the middle of a track, play the CD in the normal way. As soon as the desired passage is reached, set the CD player to pause by pressing PLAY-PAUSE ▶II. By pressing RECORD ● the CD-player and the recording will start.
 - If you press RECORD ● when CD is playing, CD playback will be interrupted. Press PLAY-PAUSE ▶II to restart playback of the CD for recording.

9. MAINTENANCE

COMPACT CASSETTES

- For recording, use a NORMAL cassette (IEC type I) on which the tabs are not broken out.
- This deck is not suited for recording on CHROME (IEC II) or METAL (IEC IV) cassettes.
- For playback, any cassette type may be inserted.
- At the very beginning and end of the tape, no recording will take place during the 6 seconds when the leader tape passes the recorder heads.
- To prevent the accidental erasure of a recording, keep the cassette side to be safeguarded in front of you and break out the left tab. Now, recording on this side is no longer possible.



- To render this safeguard ineffective, cover the aperture with a piece of adhesive tape.
- Do not expose the cassettes to rain, moisture, sand, or to excessive heat e.g. from heating equipment or in motor cars parked in the sun.

SYSTEM MAINTENANCE

- The mechanical parts of the CD player and the cassette deck contain self-lubricating bearings and must not be oiled or lubricated.
- A chamois leather slightly moistened with water is sufficient for cleaning the housing.
- Do not use cleaning agents containing alcohol, spirits, ammonia or abrasives as these may harm the housing.
- Do not leave the set, CDs, batteries or cassettes for any length of time in direct sunlight or other places where high temperatures can occur, such as in the vicinity of heating apparatus or in motor cars parked in the sun.
- Do not expose the set, CDs, batteries or cassettes to humidity or rain.

CD PLAYER MAINTENANCE

- The lens may cloud over if the CD player is moved from cold to warm surroundings. The CD player will not start. Give the player some time to acclimatise.
- Keep the CD tray free of dust using a clean cloth.

RECORDER MAINTENANCE

To ensure a good recording and playback quality, clean the indicated parts (A)(B)(C) after every 50 hours of operation or, on average, once a month.

- Open the cassette holder using STOP-EJECT ■ ▲.
- Use a cotton bud slightly moistened with alcohol or a special head cleaning fluid.

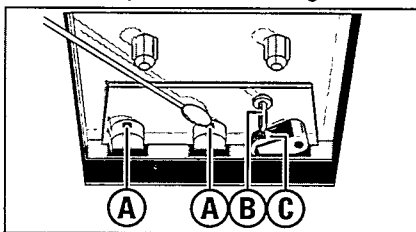

- Press PLAY ► and clean the rubber pressure rollers (C).
- Then press PAUSE II and clean the capstans (B) and the heads (A).
- After cleaning, press STOP-EJECT ■ ▲.

Cleaning of the heads (A) can also be done by playing a cleaning cassette through once.

10. TROUBLESHOOTING

If a fault occurs, first check the points listed below before taking the set for repair. If you are unable to remedy a problem by following these hints, consult your dealer or service centre.

WARNING

Under no circumstances should you try to repair the set yourself, as this would invalidate the guarantee.

PROBLEM

- POSSIBLE CAUSE
- REMEDY

System does not react to any button

- *Electrostatic discharge*
- Switch off the set, disconnect the power plug, reconnect after a few seconds.
- *No power*
- See 'No sound'

Display does not function properly

- *Electrostatic discharge*
- Switch off the set, disconnect the mains plug, reconnect after a few seconds.
- *Set runs on batteries*
- Switch to AC power

No sound

- *VOLUME is not adjusted*
- Adjust the VOLUME
- *Headphones are connected*
- Disconnect headphones
- *Batteries are exhausted*
- Insert fresh batteries
- *Batteries are incorrectly inserted*
- Insert the batteries correctly
- *Power cord is not securely connected*
- Connect the power cord properly

Bad sound

- *Unsuited speakers are used*
- Use bypacked speakers
- *Batteries are exhausted*
- Replace batteries

Poor bass sound

- *Speakers are not in phase*
- Connect speakers properly, ⊕ to ⊕-pole (red marked or sleeved cable); ⊖ to ⊖-pole (unmarked cable)

No sound on left or right side

- *Speaker wrongly connected*
- Connect speaker properly

Reversed left and right sound

- *Speakers are wrongly connected*
- Connect speakers properly, L to left, R to right

Severe radio hum or noise

- *System too close to TV, VCR or computer*
- Increase the distance

Poor radio reception

- *Weak radio aerial signal*
- FM: aim and extend the telescopic aerial for best reception;
- AM: rotate the entire set.

Poor cassette sound quality

- *Dust and dirt on the heads, capstan or pressure roller*
- Clean the heads etc., see Maintenance

Recording does not work

- *Cassette tab(s) may be broken out*
- Apply a piece of adhesive tape over the missing tab space

CD playback does not work

- *CD is badly scratched or dirty*
- Replace or clean the CD, see Maintenance
- *No CD inserted*
- Insert CD
- *CD inserted upside down*
- Insert CD with printed side facing up
- *Laser lens is steamed up*
- Wait until lens has acclimatized

The CD skips tracks

- *CD is damaged or dirty*
- Replace or clean the CD
- *PROGRAM is active*
- Switch off the PROGRAM function

Remote control does not function properly

- *Remote control batteries are incorrectly inserted*
- Insert batteries properly
- *Remote control batteries exhausted*
- Replace batteries
- *Distance to the set is too large*
- Reduce the distance

Notes

Notes

Notes

Magnavox AZ 9055 - Portable Micro System

English

English page 4

Français

Français page 17

Español

Español página 30

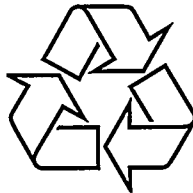

PHILIPS CONSUMER ELECTRONICS COMPANY
A Division of Philips Electronics North America Corporation
Knoxville, Tennessee 37914-1810, U.S.A.

Free Manuals Download Website

<http://myh66.com>

<http://usermanuals.us>

<http://www.somanuals.com>

<http://www.4manuals.cc>

<http://www.manual-lib.com>

<http://www.404manual.com>

<http://www.luxmanual.com>

<http://aubethermostatmanual.com>

Golf course search by state

<http://golfingnear.com>

Email search by domain

<http://emailbydomain.com>

Auto manuals search

<http://auto.somanuals.com>

TV manuals search

<http://tv.somanuals.com>