

OWNER'S MANUAL

Color Television
27MS3404R

MAGNAVOX
SMART. VERY SMART.



NEED HELP? CALL US!

MAGNAVOX REPRESENTATIVES ARE READY TO HELP YOU WITH ANY QUESTIONS ABOUT YOUR NEW PRODUCT. WE CAN GUIDE YOU THROUGH CONNECTIONS, FIRST-TIME SETUP, AND ANY OF THE FEATURES. WE WANT YOU TO START ENJOYING YOUR NEW PRODUCT RIGHT AWAY.

**CALL US BEFORE YOU CONSIDER RETURNING THE PRODUCT.
1-800-705-2000**

OR VISIT US ON THE WEB AT WWW.MAGNAVOX.COM

IMPORTANT!
RETURN YOUR WARRANTY REGISTRATION CARD WITHIN 10 DAYS.
SEE WHY INSIDE.

3121 235 21741

Return your Warranty Registration card today to ensure you receive all the benefits you're entitled to.

Once your MAGNAVOX purchase is registered, you're eligible to receive all the privileges of owning a MAGNAVOX product. So complete and return the Warranty Registration Card enclosed with your purchase at once. And take advantage of these important benefits.

Warranty Verification

Registering your product within 10 days confirms your right to maximum protection under the terms and conditions of your MAGNAVOX warranty.

Owner Confirmation

Your completed Warranty Registration Card serves as verification of ownership in the event of product theft or loss.

Model Registration

Returning your Warranty Registration Card right away guarantees you'll receive all the information and special offers which you qualify for as the owner of your model.

Congratulations on your purchase, and welcome to the "family!"



Dear MAGNAVOX product owner:

Thank you for your confidence in MAGNAVOX. You've selected one of the best-built, best-backed products available today. We'll do everything in our power to keep you happy with your purchase for many years to come.

As a member of the MAGNAVOX "family," you're entitled to protection by one of the most comprehensive warranties and outstanding service networks in the industry.

What's more, your purchase guarantees you'll receive all the information and special offers for which you qualify, plus easy access to accessories from our convenient home shopping network. Most importantly, you can count on our uncompromising commitment to your total satisfaction.

All of this is our way of saying welcome-and thanks for investing in a MAGNAVOX product.

P.S. Remember, to get the most from your MAGNAVOX product, you must return your Warranty Registration Card within 10 days. So please mail it to us right now!

Know these **safety** symbols



⚡ This "bolt of lightning" indicates uninsulated material within your unit may cause an electrical shock. For the safety of everyone in your household, please do not remove product covering.

⚠ The "exclamation point" calls attention to features for which you should read the enclosed literature closely to prevent operating and maintenance problems.

WARNING: TO PREVENT FIRE OR SHOCK HAZARD, DO NOT EXPOSE THIS EQUIPMENT TO RAIN OR MOISTURE.

CAUTION: To prevent electric shock, match wide blade of plug to wide slot, fully insert.

ATTENTION: Pour éviter les chocs électriques, introduire la lame la plus large de la fiche dans la borne correspondante de la prise et pousser jusqu'au fond.

For Customer Use

Enter below the Serial No. which is located on the rear of the cabinet. Retain this information for future reference.

Model No. _____
Serial No. _____

Visit our World Wide Web Site at <http://www.magnavox.com>

IMPORTANT SAFETY INSTRUCTIONS

Read before operating equipment

1. Read these instructions.
2. Keep these instructions.
3. Heed all warnings.
4. Follow all instructions.
5. Do not use this apparatus near water.
6. Clean only with a dry cloth.
7. Do not block any of the ventilation openings. Install in accordance with the manufacturers instructions.
8. Do not install near any heat sources such as radiators, heat registers, stoves, or other apparatus (including amplifiers) that produce heat.
9. Do not defeat the safety purpose of the polarized or grounding-type plug. A polarized plug has two blades with one wider than the other. A grounding type plug has two blades and third grounding prong. The wide blade or third prong are provided for your safety. When the provided plug does not fit into your outlet, consult an electrician for replacement of the obsolete outlet.
10. Protect the power cord from being walked on or pinched particularly at plugs, convenience receptacles, and the point where they exit from the apparatus.
11. Only use attachments/accessories specified by the manufacturer.
12.  Use only with a cart, stand, tripod, bracket, or table specified by the manufacturer, or sold with the apparatus. When a cart is used, use caution when moving the cart/apparatus combination to avoid injury from tip-over.
13. Unplug this apparatus during lightning storms or when unused for long periods of time.
14. Refer all servicing to qualified service personnel. Servicing is required when the apparatus has been damaged in any way, such as power-supply cord or plug is damaged, liquid has been spilled or objects have fallen into apparatus, the apparatus has been exposed to rain or moisture, does not operate normally, or has been dropped.
15. This product may contain lead and mercury. Disposal of these materials may be regulated due to environmental considerations. For disposal or recycling information, please contact your local authorities or the Electronic Industries Alliance: www.eiae.org
16. **Damage Requiring Service** - The appliance should be serviced by qualified service personnel when:
 - A. The power supply cord or the plug has been damaged; or
 - B. Objects have fallen, or liquid has been spilled into the appliance; or
 - C. The appliance has been exposed to rain; or
 - D. The appliance does not appear to operate normally or exhibits a marked change in performance; or
 - E. The appliance has been dropped, or the enclosure damaged.
17. **Tilt/Stability** - All televisions must comply with recommended international global safety standards for tilt and stability properties of its cabinet design.
 - Do not compromise these design standards by applying excessive pull force to the front, or top, of the cabinet which could ultimately overturn the product.
 - Also, do not endanger yourself, or children, by placing electronic equipment/toys on the top of the cabinet. Such items could unsuspectingly fall from the top of the set and cause product damage and/or personal injury.
18. **Wall or Ceiling Mounting** - The appliance should be mounted to a wall or ceiling only as recommended by the manufacturer.
19. **Power Lines** - An outdoor antenna should be located away from power lines.
20. **Outdoor Antenna Grounding** - If an outside antenna is connected to the receiver, be sure the antenna system is grounded so as to provide some protection against voltage surges and built up static charges.

Section 810 of the National Electric Code, ANSI/NFPA No. 70-1984, provides information with respect to proper grounding of the mast and supporting structure, grounding of the lead-in wire to an antenna discharge unit, size of grounding connectors, location of antenna-discharge unit, connection to grounding electrodes, and requirements for the grounding electrode. See Figure below.
21. **Object and Liquid Entry** - Care should be taken so that objects do not fall and liquids are not spilled into the enclosure through openings.
22. **Battery Usage CAUTION** - To prevent battery leakage that may result in bodily injury, property damage, or damage to the unit:
 - Install all batteries correctly, with + and - aligned as marked on the unit.
 - Do not mix batteries (old and new or carbon and alkaline, etc.).
 - Remove batteries when the unit is not used for a long time.

Note to the CATV system installer: This reminder is provided to call the CATV system installer's attention to Article 820-40 of the NEC that provides guidelines for proper grounding and, in particular, specifies that the cable ground shall be connected to the grounding system of the building, as close to the point of cable entry as practical.

Example of Antenna Grounding as per NEC - National Electric Code

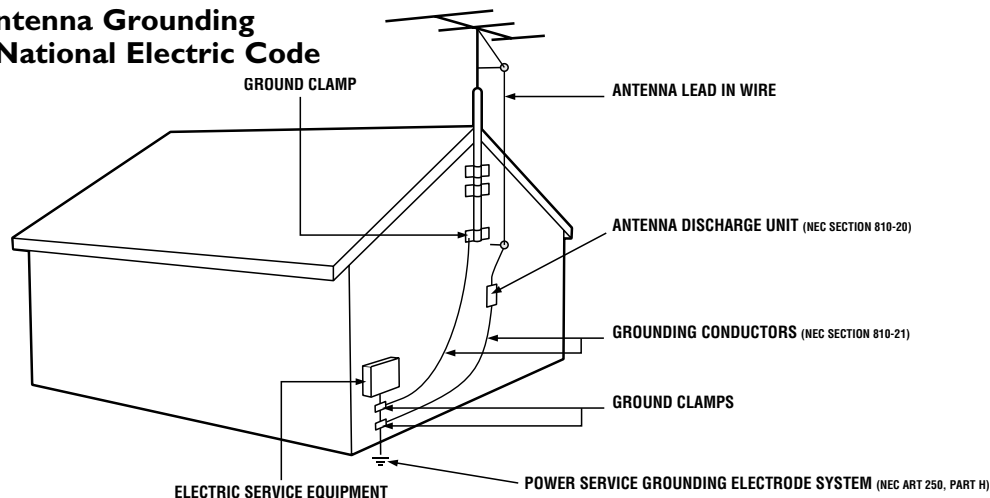

CONTENTS

Introduction

Welcome/TV Registration	2
Safety Instructions	3
Table of Contents	4
Features	4



Getting Started

Basic TV and Remote Control Operation	5
Remote Control	6
Basic Antenna Connection	7
Basic Cable TV Connection	7
Cable Box Connection	8
Audio/Video Input Connections	9
S-Video Connections	10
Component Video Connections	11
Audio/Video Outputs	12
Side Audio/Video Inputs	13



Install Menu

Menu Language	14
Tuner Mode	15
Auto Program (Setting Up Channels)	16
Channel Edit	17



Picture Menu

Picture Adjustment Controls	18
-----------------------------	----



Sound Menu

Sound Adjustment Controls	19
---------------------------	----



Features Menu

Using the Format (Expand 4:3) Control	20
SmartLock™	21
SmartLock™ - Access Code	22
SmartLock™ - Block Channels	23
SmartLock™ - Clear All	24
SmartLock™ - Block All	25
SmartLock™ - Movie Ratings	26
SmartLock™ - TV Ratings	27
SmartLock™ - Blocking Options	28



Remote Control Use

Sleeptimer	29
Closed Captioning	30
SmartPicture™	31
SmartSound™	32
Alternate Channel	33

General Information

Troubleshooting Tips	34
Cleaning and Care	35
Glossary of Terms	36
Index	37
Factory Service Location	38-39
Warranty	40

Here are a few of the features built into your new Television:

Audio/Video Jack panel located on the back and side of the television for direct connections when using audio/video accessory devices. These Jacks can provide improved quality TV picture and sound playback.

Automatic Programming of Channels for quick and easy selection of favorite stations available in your area.

Closed Captioning allows the viewer to read TV program dialogue or voice conversations as on-screen text.

Expand 4:3 will allow you to expand the "letterbox" image produced by certain DVD players to fill the entire TV screen.

Infrared Remote Control works your TV set and allows you to program certain features with the press of a button.

On-screen Features (in either English or Spanish) show helpful messages for setting of TV controls.

Sleeptimer automatically turns the TV OFF at preset times.

SmartLock™ feature allows you to block the viewing of certain channels or external audio/video connections where you might not want your children viewing inappropriate material.

SmartPicture™ allows you to set the picture color, tint, contrast, etc. for various types of programming such as Sports, Movies, Personal, Weak Signal, or Multimedia with the push of a button.

SmartSound™ controls allow you to set the sound controls for various types of listening programs such as Personal (sound controls the way you set them), Theater, Music, or Voice with the push of a button.

Standard broadcast (VHF/UHF) or Cable TV (CATV) channel capability with stereo sound.

Treble Boost, Bass Boost, and Balance controls to enhance the television's sound.

Some models refer to SmartLock as AutoLock, your TV may show AutoLock instead of SmartLock in the on-screen menu. These features are the same.

NOTE: It is possible that this owner's manual may be used with several different television models. Not all features (and drawings) discussed in this manual will necessarily match those found with your television system. This is normal and does not require you contacting your dealer or requesting service.

END-OF-LIFE DISPOSAL

Your new television and its packing contain materials that can be recycled and reused. Specialized companies can recycle your product to increase the amount of reusable materials and minimize the amounts that need to be properly disposed.

Your product also uses batteries that should not be thrown away when depleted, but should be handed in and disposed of as small chemical waste.

When you replace your existing equipment, please find out about the local regulations regarding disposal of your old television, batteries, and packing materials.

SmartLock, SmartPicture, SmartSound, and SmartSurf are all registered trademarks of Philips Consumer Electronics North America. Copyright © 2003 Magnavox. All rights reserved.

BASIC TV AND REMOTE CONTROL OPERATION



TELEVISION

- 1 Press the POWER button** to turn the TV ON.
Note: You can also press any button on the front of the TV to turn the TV ON.
- 2 Press the VOLUME + button** to increase the sound level, **or the VOLUME - button** to lower the sound level.
- 3 Press the CHANNEL UP ▲ or DOWN ▼ button** to select TV channels.

REMOTE CONTROL

- 4 Point the remote control** toward the remote sensor window on the TV when operating the TV with the remote.

BATTERY INSTALLATION

- 5 Remove the battery compartment lid** on the back of the remote.
- 6 Place the batteries (2-AA) in the remote.** Be sure the (+) and (-) ends of the batteries line up correctly (inside of case is marked.)
- 7 Reattach the battery lid.**

HELPFUL HINT

Remember, the tuned channel number will always briefly appear when the TV is first turned ON (and with channel changes.)

You can also press the STATUS/EXIT button (on the remote) to see what channel the TV is ON.

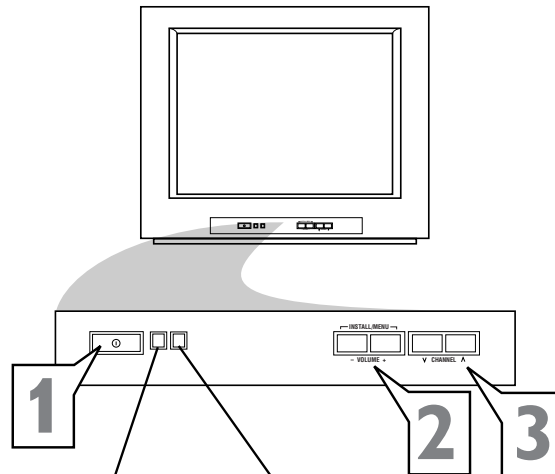

Standby Light Indicator - Red light will show when in the Standby Mode. Press the Power button to return the TV to its active state.

Remote Sensor - Sensor for activating remote control commands when the remote is used to control the TV.

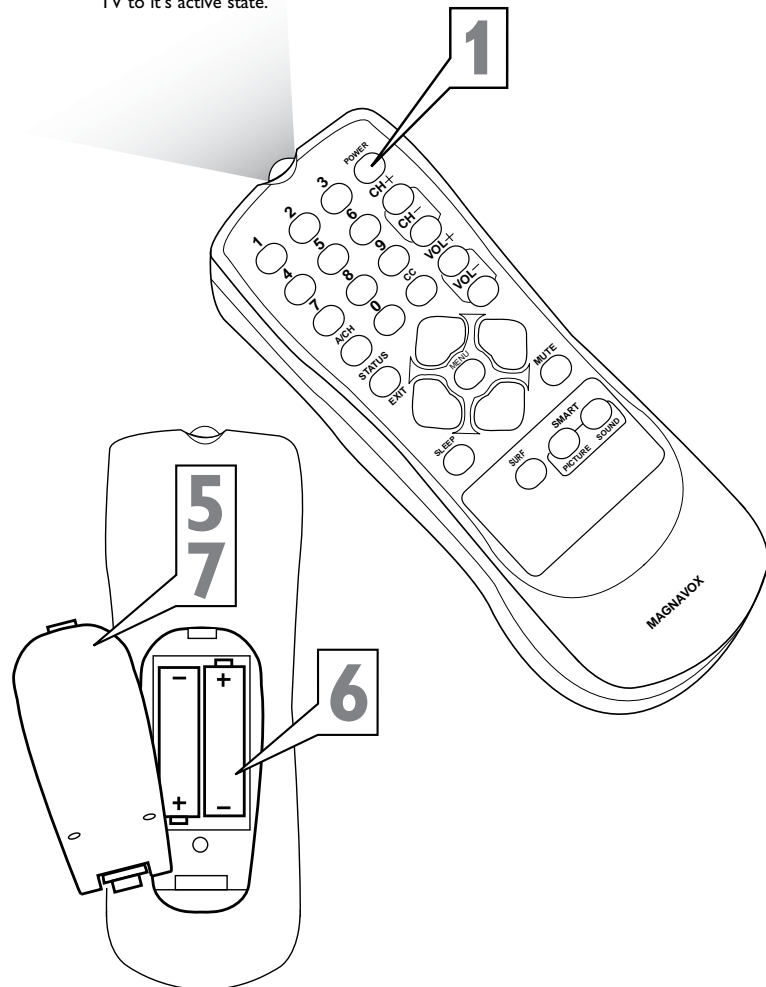



DESCRIPTION OF REMOTE CONTROL BUTTONS

NUMBER Buttons

Press the Number buttons to select TV channels or to enter values in the menu. For single-digit channels, press the Number button for the channel you want. The TV will pause briefly before going to the chosen channel.

A/CH Button (Alternate Channel)

Press to switch between the last channel and the present channel.
Details are on page 33.

STATUS/EXIT Button

Press to see the current channel number. Press to remove a menu.

CC Button

Press to activate Closed Captioning.
Details are on page 30.

SLEEP Button

Press to set the TV to turn itself off within a certain time. *Details are on page 29.*

Note:

This button is dedicated to SmartSurf features within certain TV models. This TV does not contain the SmartSurf features, so therefore the button will have no functionality when pressed.

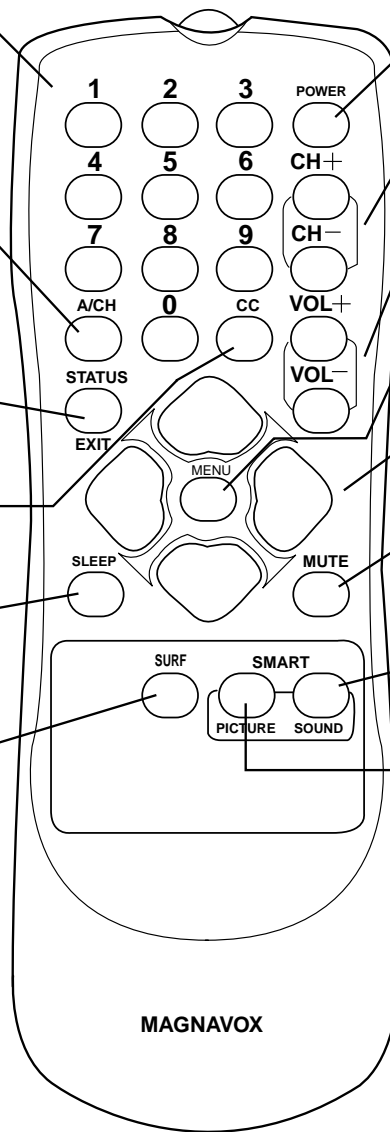

POWER button

Press to turn the TV on or off.

CH(annel) +/- Buttons

Press to scan memorized channels.

VOL(ume) +/- Buttons

Press to increase or decrease the sound.

MENU Button

Press to see the menu. Press repeatedly to return to previous menus or remove the menus.

Arrow ◀ ▶ ▲ ▼ Buttons

Press to select or adjust items in the menu.

MUTE Button

Press to eliminate or restore the TV sound. MUTE will appear on the TV when the sound is muted.

SMART SOUND Button

Press to choose a sound setting.
Details are on page 31.

SMART PICTURE Button

Press to choose a picture setting.
Details are on page 32.

BASIC ANTENNA CONNECTION



A combination antenna receives normal broadcast channels (VHF 2–13 and UHF 14–69). Your connection is easy because there is only one 75Ω (ohm) antenna plug on the back of your TV, and that's where the antenna goes.

- 1** If your antenna has a round cable (75 ohm) on the end, then you're ready to connect it to the TV. If your antenna has a flat, twin-lead wire (300 ohm), you first need to attach the antenna wires to the screws on a 300- to 75-ohm adapter.
- 2** Push the round end of the adapter (or antenna) onto the 75Ω (ohm) plug on the back of the TV. If the round end of the antenna wire is threaded, screw it down finger tight.

Antenna Connection:

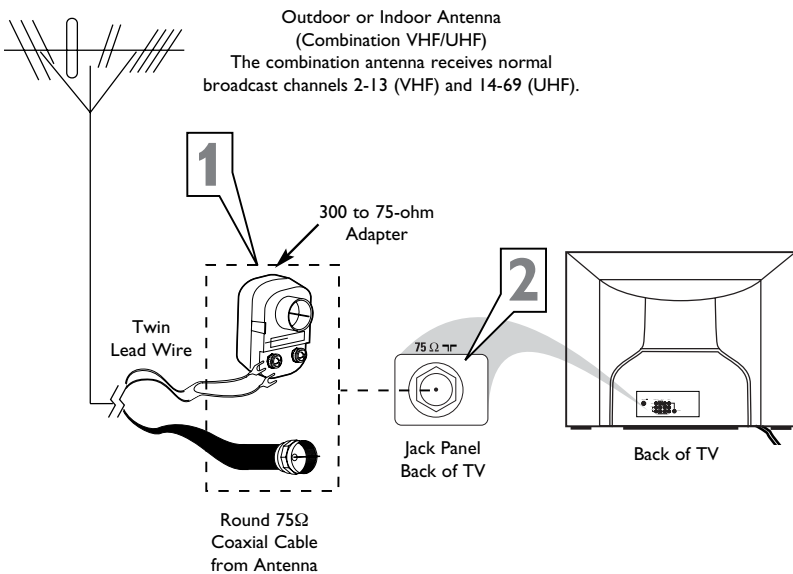

HELPFUL HINT

After using the AutoProgram Control, press the CH + and – buttons to scroll through all the channels stored in the television's memory.

BASIC CABLE TV CONNECTION



The Cable TV input into your home may be a single (75 ohm) cable. If so, this connection is very simple. Follow the steps below to connect your cable signal to your new television.

Direct Cable Connections:

- 1** Connect the open end of the round Cable Company supplied cable to the 75Ω input on the TV. Screw it down finger tight.

Direct Cable Connection:

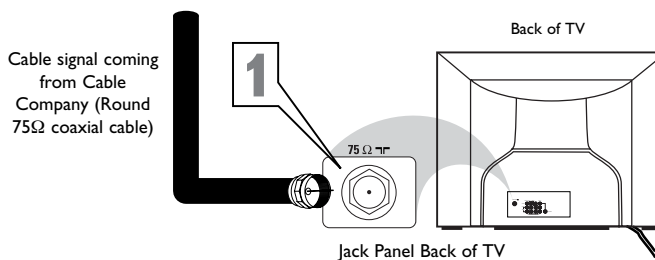



BASIC CABLE BOX/DECODER CONNECTION

If your cable signal uses a cable box or decoder, follow the easy steps below to complete the connection.

Cable Box (w/RF In/Outputs):

This connection will NOT supply Stereo sound to the TV. The sound from the cable box will be mono.

- 1** Connect the open end of the round Cable Company supplied cable to the cable signal IN(put) plug on the back of the Cable Box.
- 2** Using a separate round coaxial cable, connect one end to the OUT(put) (TO TV) plug on the back of the Cable Box.
- 3** Connect the other end of the round coaxial cable to the 75Ω input on the back of the television. Screw it down finger tight.

NOTE: Be sure to set the OUTPUT CHANNEL SWITCH on the back of the cable box to CH 3 or 4, then tune the TV to the corresponding channel. Once tuned, change channels at the cable box, not the television.

Cable Box (w/Audio/Video Outputs):

This connection will supply Stereo sound to the TV.

- 4** Connect the open end of the round Cable Company supplied cable to the cable signal IN(put) plug on the back of the Cable Box.
- 5** Using a RCA type Video Cable, connect one end of the cable to the Video (or ANT, your cable box may be labeled differently) Out jack on the cable box and the other end to the AV1 Video Input on the TV.
- 6** Using a RCA type Audio Left and Right Cable, connect one end to the left and right Audio Out L & R jacks on the cable box. Connect the other end to the AV1 Audio L & R Input jacks on the TV.

NOTE: Use the Channel + or – buttons on the TV remote control to tune to the AV1 channel for the cable box signal. Once tuned, change channels at the cable box, not the television.

Cable Box Connection (RF Input/Output Only):

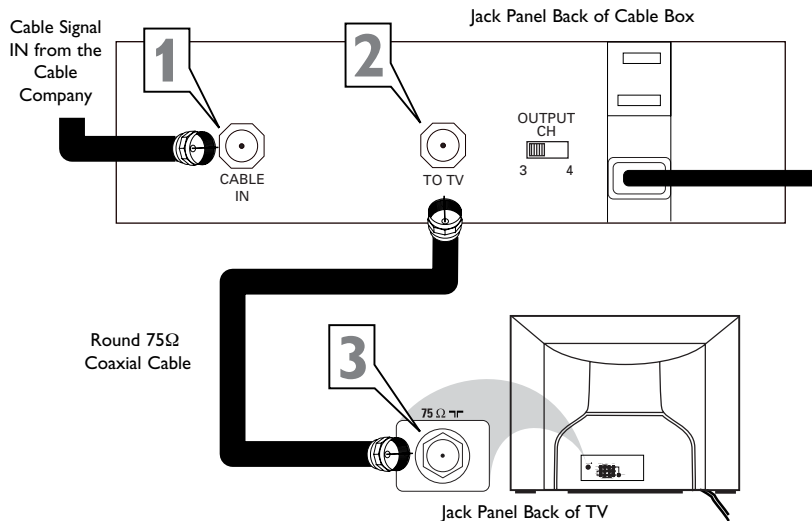

Cable Box Connection (with Audio/Video Outputs):

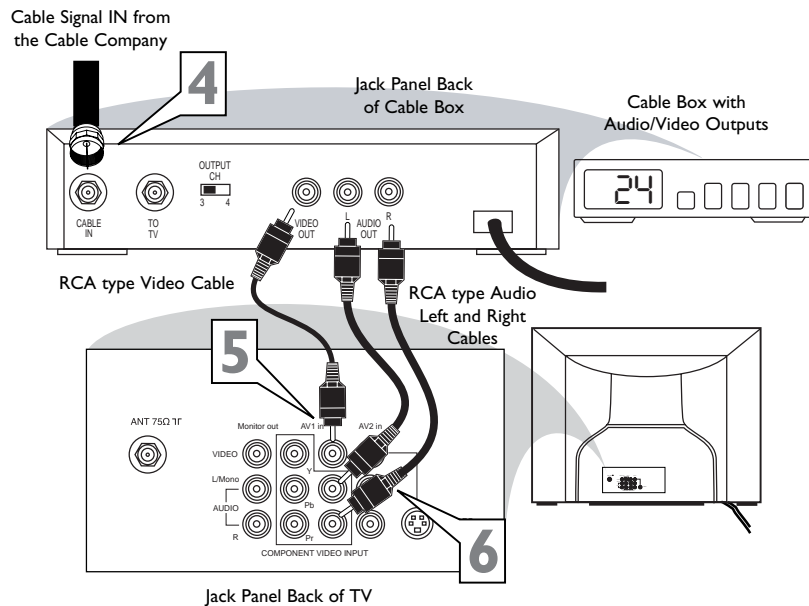

USING THE AV1 IN OR AV2 IN (INPUT) JACKS



The TV's audio/video input jacks are for direct picture and sound connections between the TV and a VCR (or similar device) that has audio/video output jacks. Both the AV1 and AV2 Input Jack connections are shown on this page, but either one can be connected alone. Follow the easy steps below to connect your accessory device to the AV1 and AV2 IN Jacks located on the back of the TV.

- 1** Connect the **VIDEO (yellow)** cable to the VIDEO AV1 IN (or AV2 IN) jack on the back of the TV.
- 2** Connect the **AUDIO (red and white)** cables to the AUDIO (left and right) AV1 IN (or AV2 in) jacks on the rear of the TV.
- 3** Connect the **VIDEO (yellow)** cable to the VIDEO OUT jack on the back of the VCR (either one or two) or accessory device being used.
- 4** Connect the **AUDIO (red and white)** cables to the AUDIO (left and right) OUT jacks on the rear of the VCR (either one or two) or accessory device being used.
- 5** Turn the VCR (either one or two) or accessory device and the TV ON.
- 6** Press the CH + or CH- buttons to set the TV to its AV1 or AV2 channel. (Go to your lowest channel, for example channel 1, then change channels down to find the correct input.)
- 7** With either of the VCRs (or accessory devices) ON and a prerecorded tape (CD, DVD, etc.) inserted, press the **PLAY** button to view the tape on the television.

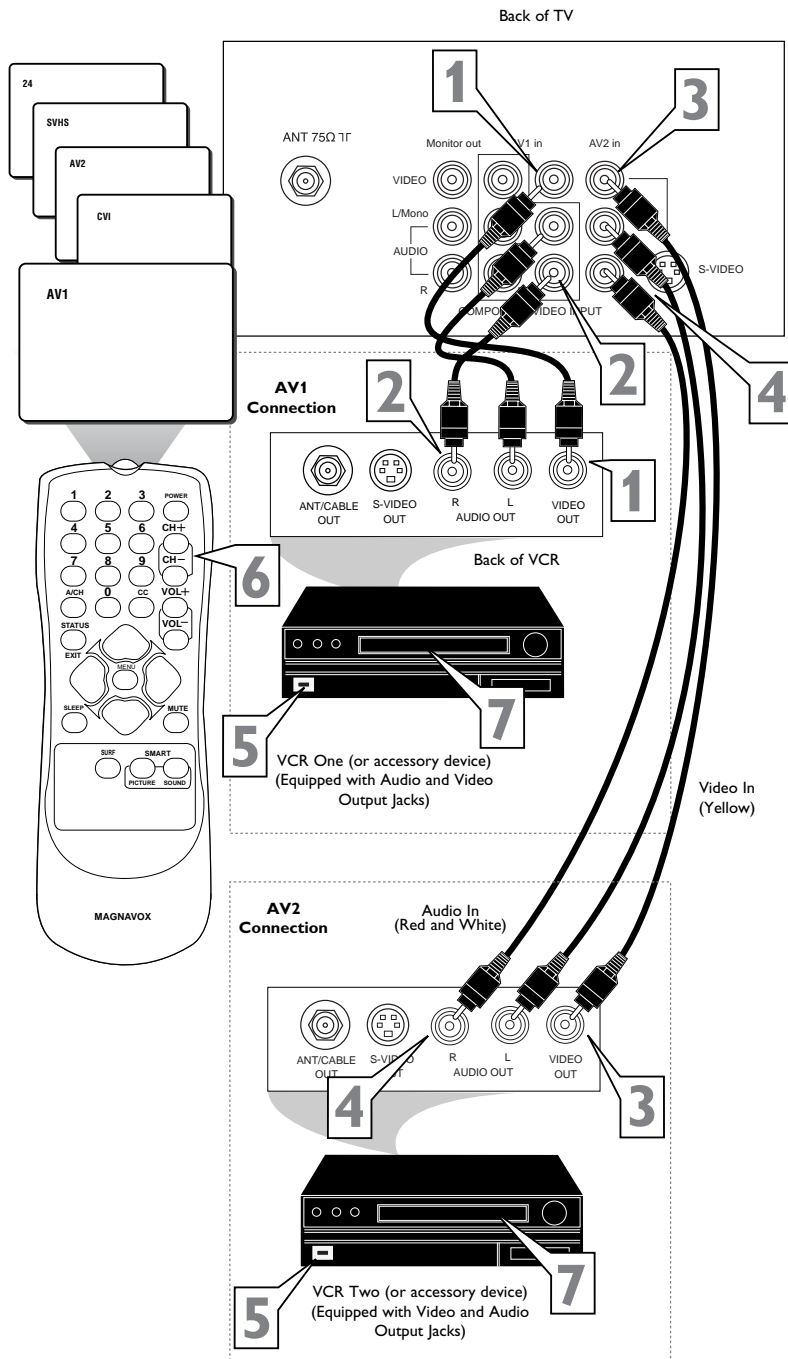

HELPFUL HINT

Audio and video cables are not supplied with the TV, but are available from Magnavox or electronics retailers.



USING THE S-VIDEO INPUT JACKS

The S(uper)-Video connection on the rear of the TV can provide you with better picture detail and clarity for the playback of accessory sources such as DBS (digital broadcast satellite), DVD (digital video discs), video games, and S-VHS VCR (video cassette recorder) tapes than the normal antenna picture connections.

NOTE: The accessory device must have an S-VIDEO OUT(put) jack in order for you to complete the connection on this page.

- 1** Connect one end of the **S-VIDEO CABLE** to the S-VIDEO jack on the back of the TV. Then connect one end the **AUDIO (red and white) CABLES** to the AV2 in AUDIO L and R (left and right) jacks on the rear of the TV.
- 2** Connect other end of the **S-VIDEO CABLE** to the S-VIDEO OUT jack on the back of the VCR. Then connect the other ends of the **AUDIO (red and white) CABLES** to the AUDIO (left and right) OUT jacks on the rear of the VCR.
- 3** Turn the **VCR and the TV ON.**
- 4** Press the **CH +** or **CH-** buttons to set the TV to its **SVHS2** channel. (Go to your lowest channel, for example channel 1, then change channels down to find the correct source channel.)
- 5** Now your ready to place a prerecorded video tape in the VCR and press the **PLAY** button.

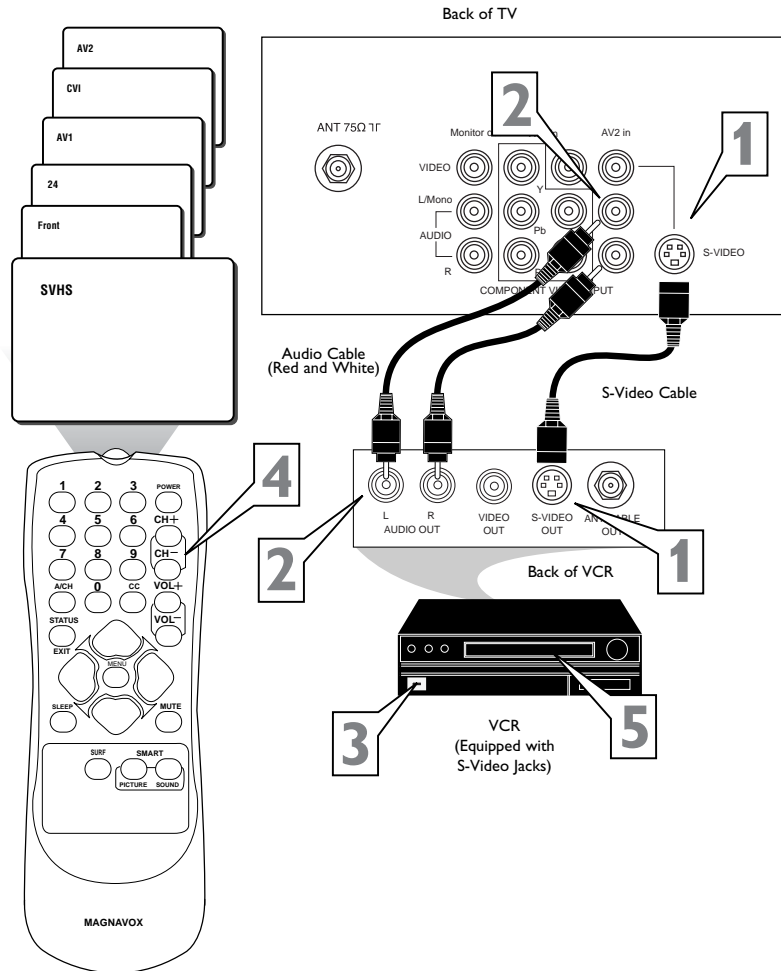

HELPFUL HINT

The S-VIDEO and VIDEO AV2 in(puts) are in parallel. The S-VIDEO input is dominant when in use. If separate video signals are connected to the S-VIDEO and VIDEO AV2 in(puts), the signal from the VIDEO AV2 in(puts) will not be usable.

Audio and S-Video cables are not supplied with the TV, but are available from Magnavox or electronics retailers.

USING THE CVI (COMPONENT VIDEO INPUT) JACKS

Component Video inputs provide for the highest possible color and picture resolution in the playback of digital signal source material, such as with DVD players. The color difference signals (Pb, Pr) and the luminance signal (Y) connected and received separately, which allows for improved color bandwidth information (not possible when using composite video or S-Video connections).

- 1** Connect the Component (Y, Pb, Pr) Video OUT jacks from the DVD player (or similar device) to the (Y, Pb, Pr) in(put) jacks on the TV. When using the Component Video Inputs, it is best not to connect a signal to the AV1 IN Video Jack.
- 2** Connect the red and white AUDIO CABLES to the Audio (left and right) output jacks on the rear of the accessory device to the Audio (L and R) AV1 IN Input jacks on the TV.
- 3** Turn the TV and the DVD (or digital accessory device) ON.
- 4** Press the CH + or CH- buttons to set the TV to its CVI channel. (Go to your lowest channel, for example channel 1, then change channels down to find the correct source channel.)
- 5** Insert a DVD disc into the DVD player and press the PLAY button on the DVD Player.

HELPFUL HINT

The description for the component video connectors may differ depending on the DVD player or accessory digital source equipment used (for example, Y, Pb, Pr; Y, B-Y, R-Y; Y, Cr, Cb). Although abbreviations and terms may vary, the letters *b* and *r* stand for the blue and red color component signal connectors, and *Y* indicates the luminance signal. Refer to your DVD or digital accessory owner's manual for definitions and connection details.

Note: Component video and audio cables are not supplied with the TV, but are available from Magnavox or electronics retailers.

The CVI connection will dominate over the AV1 in Video Input. When a Component Video Device is connected as described, it is best not to have a video signal connected to the AV1 in Video Input jack.

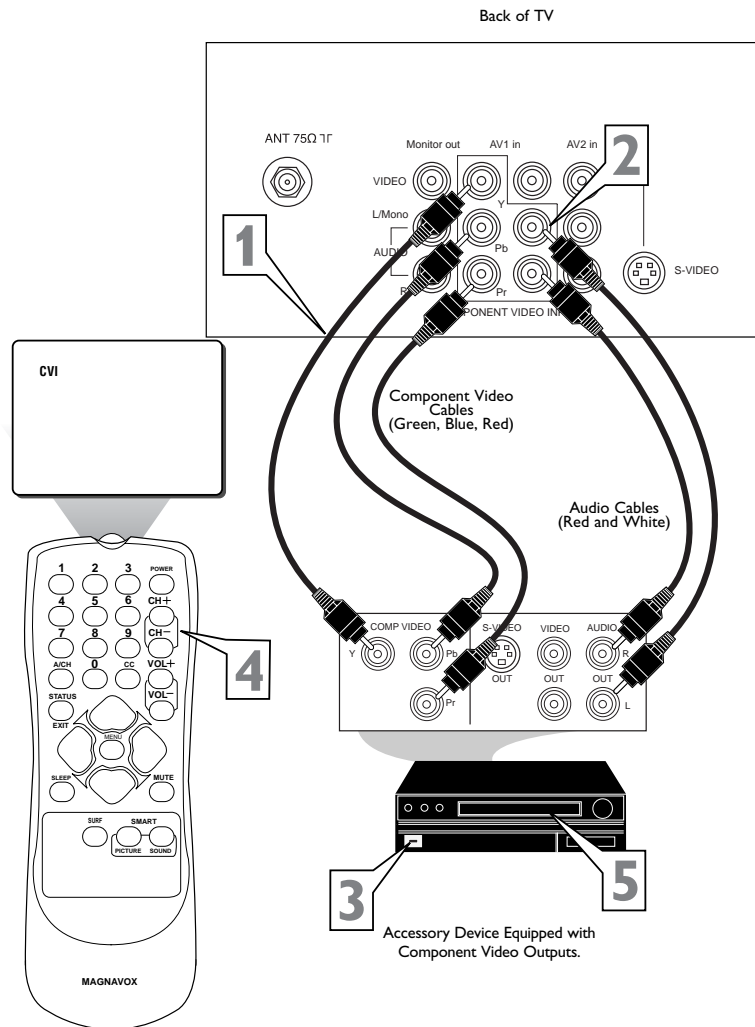



USING THE MONITOR OUT(PUT) JACKS

The Monitor (Audio/Video) out jacks are great for recording with a VCR or used to connect an external audio system for better sound reproduction.

For Audio System Connection:

- 1 Connect one end of the R(ight) and L(ef) AUDIO (Monitor Out) jacks on the TV to the R and L audio input jacks on your amplifier or sound system.** Set the audio system's volume to a normal listening level.
- 2 Turn the TV and audio system ON.** You can now adjust the sound level coming from the audio system with the VOLUME (+) or (-) button on the TV or remote control.

HELPFUL HINT

Audio and video cables are not supplied with the TV, but are available from Magnavox or electronics retailers.

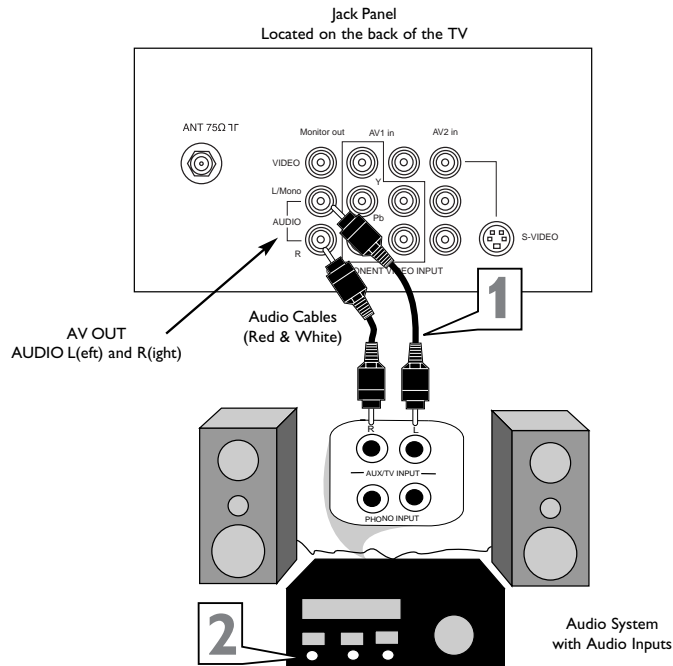

For Second VCR Connection/Recorder:

NOTE: Refer to page 9 for the proper hookup of the first VCR. Follow the instructions on how to tune to the AV1 channel to view a pre-recorded tape.

The following steps allow you to connect a second VCR to record the program while your watching it.

- 3 Connect one end of the yellow Video Cable to the Monitor out VIDEO plug.** Connect the other end to the VIDEO IN plug on the second VCR.
- 4 Connect one end of the red and white Audio cable from the Monitor out AUDIO L and R plugs on the TV to the AUDIO IN plugs on the VCR.**
- 5 Turn the Second VCR ON,** insert a VHS tape and it's ready to record what's being viewed on the TV screen.

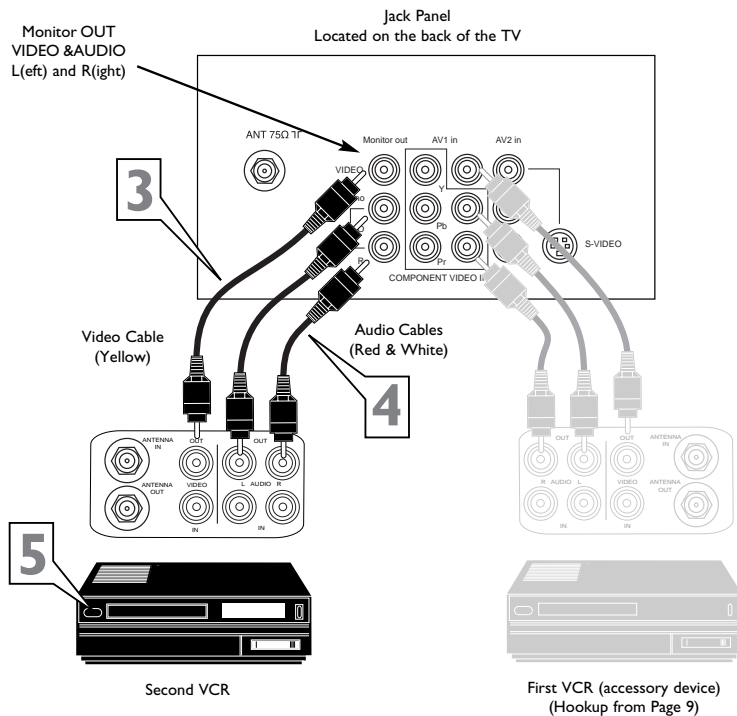

USING THE SIDE AUDIO/VIDEO INPUTS



Audio and Video Side Inputs are available for a quick connection of a VCR, to playback video from a camera or attach a gaming device. Use the AV button on the remote control to tune these inputs.

Side A/V Input Connection:

1 Connect the video (yellow) cable from the Video output on the Camera (or accessory device) to the Video (yellow) Input located on the SIDE of the TV.

2 For Stereo Devices: Connect the audio cable (red and white) from the Audio Left and Right Outputs on the Camera to a Stereo to Mono adapter. Then plug the single end of the adapter to the Audio In (white) jack on the SIDE of the television.

For Mono Devices: Connect one end of the audio cable from the Audio Out jack on the device to the Audio In (white) jack on the SIDE of the television.

3 Turn the TV and the accessory device ON.

4 Press the CH + or CH- buttons to set the TV to its Front channel. (Go to your lowest channel, for example channel 1, then change channels down to find the correct source channel.)

5 Press the PLAY ► button on the accessory device to view playback, or to access the accessory device (camera, gaming unit, etc.).

HELPFUL HINT

Audio and video cables are not supplied with the TV, but are available from Magnavox or electronics retailers.

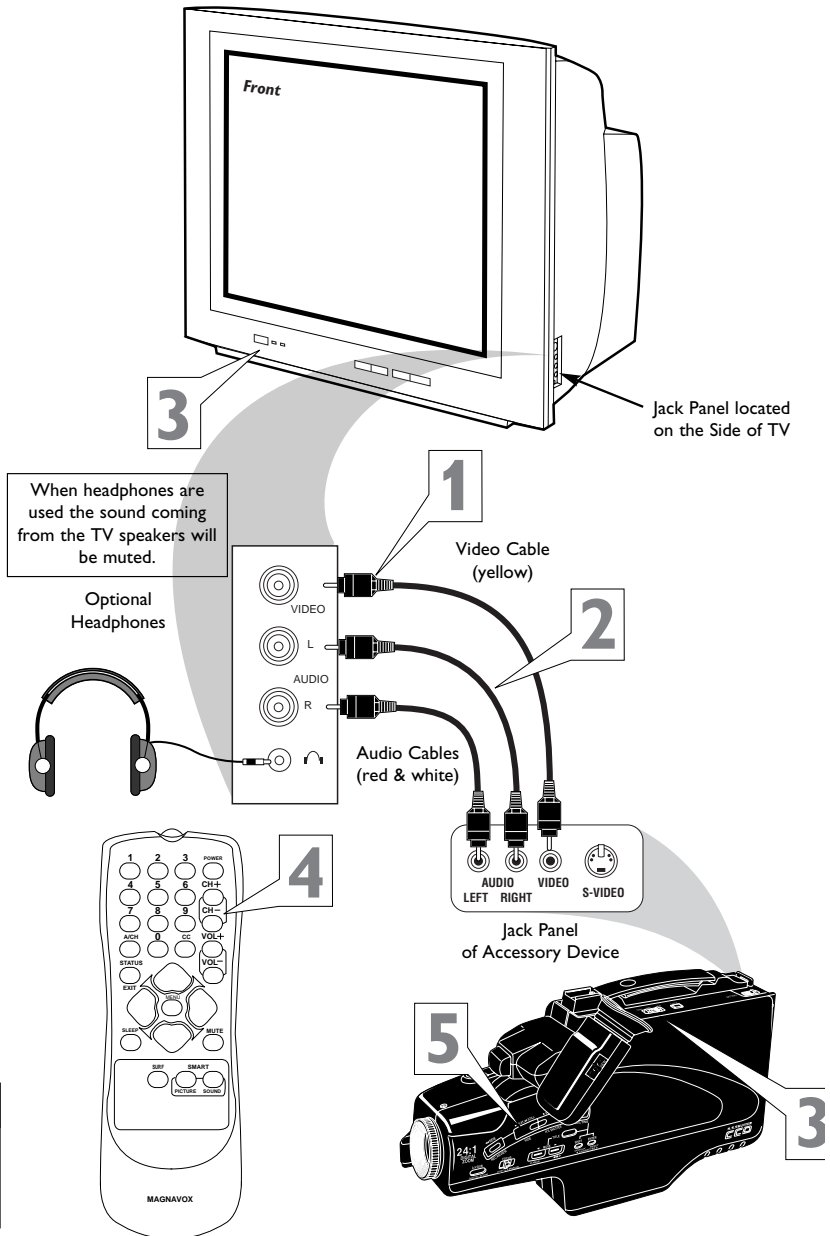



HOW TO USE THE LANGUAGE CONTROL

For our Spanish speaking TV owners an on-screen LANGUAGE option is present. With the LANGUAGE control you can set the TV's on-screen menu to be shown in either English or Spanish.

- 1** Press the **MENU** button on the remote to show the on-screen menu.
- 2** Press the **CURSOR UP ▲** or **DOWN ▼** buttons to scroll through the on-screen menu until the word **INSTALL** is highlighted.
- 3** Press the **CURSOR RIGHT ►** button to display the **INSTALL** menu features.
- 4** Press **CURSOR UP ▲** or **DOWN ▼** buttons to scroll the Install features until the word **LANGUAGE** is highlighted.
- 5** Press the **CURSOR RIGHT ►** button repeatedly to select **ENGLISH** or **ESPAÑOL** (Spanish).
- 6** When finished, press the **STATUS/EXIT** button to remove the menu from the TV's screen.

HELPFUL HINT

The Language control only makes the TV's on-screen MENU items appear in English or Spanish text.

It does not change the other on-screen text features such as Closed Caption (CC) TV shows.

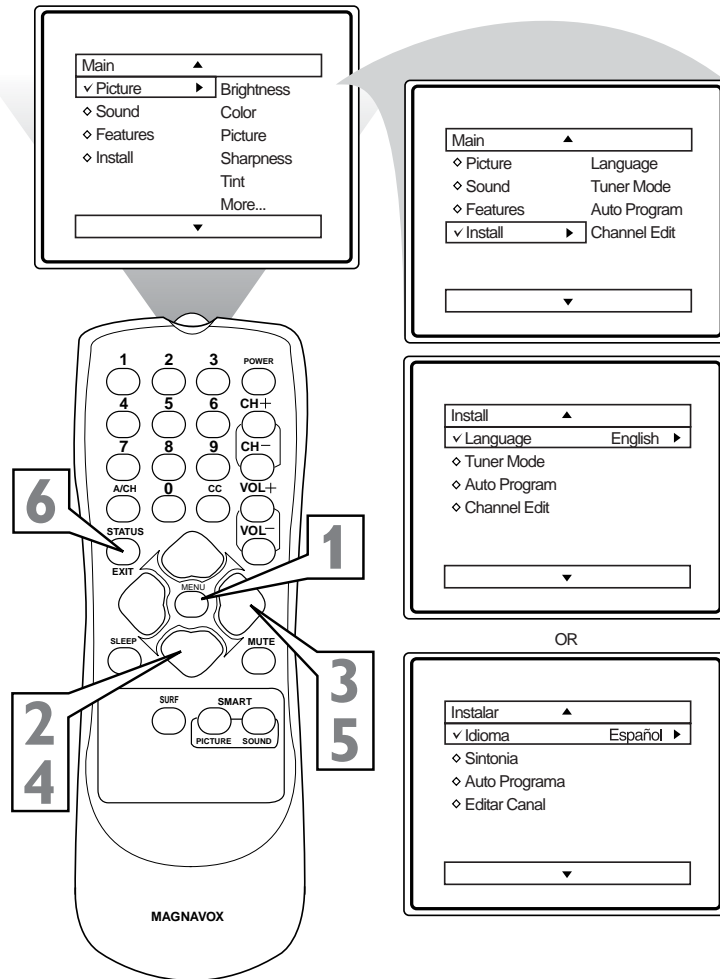

HOW TO USE THE TUNER MODE CONTROL



The **TUNER MODE** control allows you to change the TV's signal input to either **ANTENNA**, **CABLE**, or **AUTO** mode. It's important for the TV to know what type of signal that is connected. (From a Cable TV signal or a normal Antenna signal.) In the **AUTO** mode, when the **AUTO PROGRAM** feature is activated, the TV will automatically choose the correct mode.

- 1** Press the **MENU** button on the remote to show the on-screen menu.
- 2** Press the **CURSOR UP ▲** or **DOWN ▼** buttons to scroll through the on-screen menu until the word **INSTALL** is highlighted.
- 3** Press the **CURSOR RIGHT ►** button to display the **INSTALL** menu features.
- 4** Press **CURSOR UP ▲** or **DOWN ▼** buttons to scroll the Install features until the words **TUNER MODE** is highlighted.
- 5** Press the **CURSOR RIGHT ►** button to select either **ANTENNA**, **CABLE**, or **AUTO** mode.
- 6** When finished, press the **STATUS /EXIT** button to remove the on-screen menu from the TV's screen.

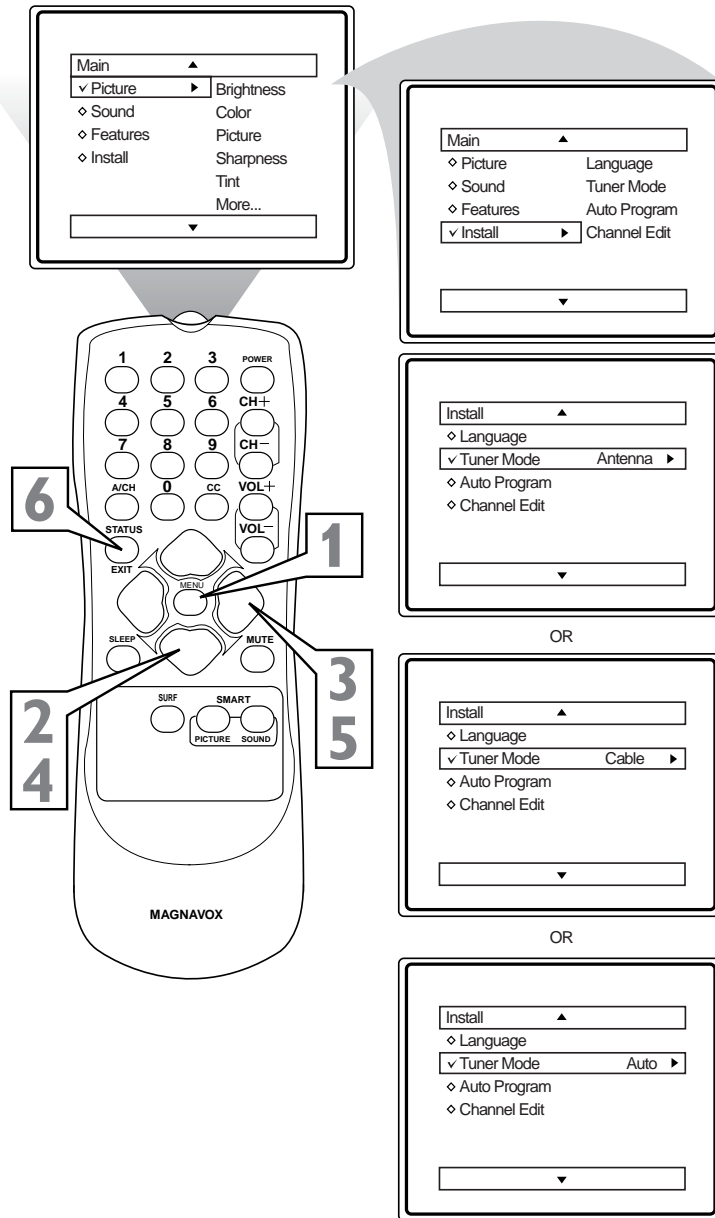

HELPFUL HINT

When **CABLE** is selected, channels 1-125 are available.
 When **ANTENNA** is selected, channels 2-69 are available.
 When **AUTO** is selected, the TV will automatically set itself to the correct mode based on the type of signal it detects when the **AUTO PROGRAM** feature is activated.



HOW TO AUTOMATICALLY PROGRAM CHANNELS

Your TV can automatically set itself for local area (or Cable TV) channels. This makes it easy for you to select only the TV stations in your area when the CHANNEL (+) or (-) buttons are pressed.

Note: Make sure the antenna or cable signal connection has been completed before AUTO PROGRAM is activated.

- 1** Press the **MENU** button on the remote to show the on-screen menu.
- 2** Press the **CURSOR UP ▲** or **DOWN ▼** buttons to scroll through the on-screen menu until the word **INSTALL** is highlighted.
- 3** Press the **CURSOR RIGHT ►** button to display the **INSTALL** menu features.
- 4** Press **CURSOR UP ▲** or **DOWN ▼** buttons to scroll the Install features until the words **AUTO PROGRAM** are highlighted.
- 5** Press the **CURSOR RIGHT ►** button to start the Auto Program scanning of channels. Auto Programming will store all available channels in the TV's memory then tune to the lowest available channel when done.
- 6** When finished, press the **STATUS/EXIT** button to remove the menu from the TV's screen.

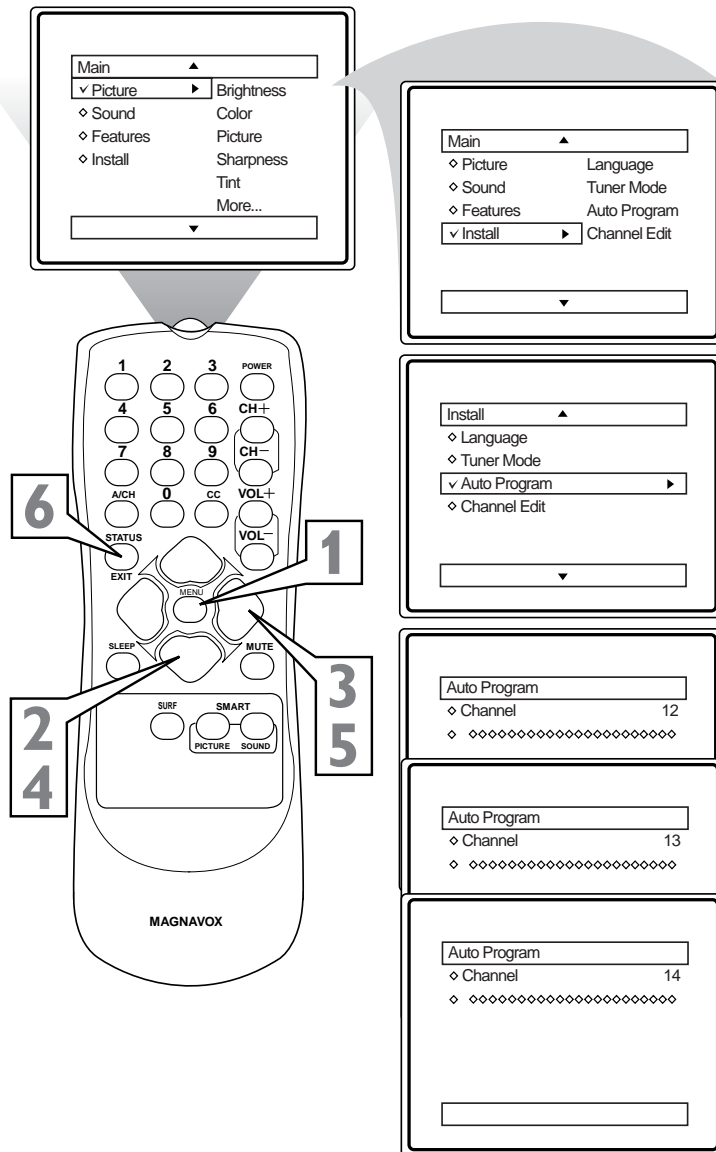

HELPFUL HINT

When CABLE is selected, channels 1-125 are available.

When ANTENNA is selected, channels 2-69 are available.

When AUTO is selected, the TV will automatically set itself to the correct mode based on the type of signal it detects when the AUTO PROGRAM feature is activated.

HOW TO ADD OR DELETE CHANNELS



Channel Edit makes it easy for you to ADD or DELETE channels from the list of channels stored in the TV's memory.

- 1** Press the **MENU** button on the remote to show the on-screen menu.
- 2** Press the **CURSOR UP ▲** or **DOWN ▼** buttons to scroll through the on-screen menu until the word **INSTALL** is highlighted.
- 3** Press the **CURSOR RIGHT ►** button to display the **INSTALL** menu features.
- 4** Press the **CURSOR UP ▲** or **DOWN ▼** buttons to scroll the Install features until the words **CHANNEL EDIT** are highlighted.
- 5** Press the **CURSOR RIGHT ►** button to display the **CHANNEL EDIT** options.
- 6** With the **CHANNEL EDIT** options displayed, and **CHANNEL NO.** highlighted; enter the channel number (with the **NUMBERED** or the **CH +** or **-** buttons) you wish to add (Skipped OFF), or delete (Skipped ON) from the TV's memory.
- 7** Using the **CURSOR DOWN ▼** button, scroll the menu to highlight the word **SKIPPED**.
- 8** Now use the **CURSOR RIGHT ►** button to toggle between **ON** or **OFF**.
If **ON** is selected the channel is skipped when scrolling channels with the CH + or - buttons. If **OFF** is selected the channel is not skipped when scrolling channels with the CH + or - buttons.
- 9** When finished, press the **STATUS/EXIT** button to remove the menu from the TV's screen.

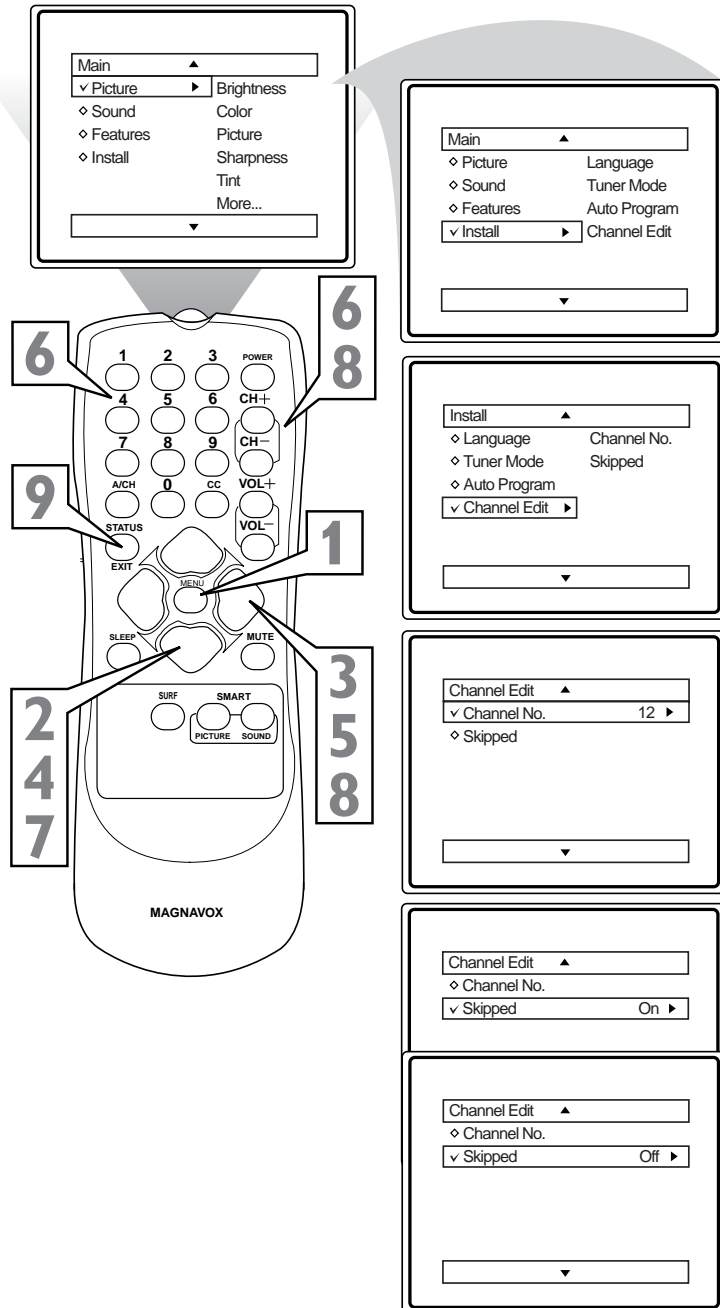



HOW TO USE THE PICTURE ADJUSTMENT CONTROLS

To adjust your TV picture controls, select a channel and follow the steps shown below:

- 1** Press the **MENU** button on the remote to display the on-screen menu.
- 2** Press the **CURSOR UP ▲** or **DOWN ▼** buttons until the word **PICTURE** is highlighted.
- 3** Press the **CURSOR RIGHT ►** button to display the **PICTURE** menu features.
- 4** Press **CURSOR UP ▲** or **DOWN ▼** buttons to scroll the Picture features and highlight the control you wish to adjust (Brightness, Color, Picture, Sharpness, Tint, Color Temp., DNR, or Contrast +).
- 5** Press the **CURSOR RIGHT ►** or the **CURSOR LEFT ◀** buttons to adjust the selected control or to make selections for the chosen control.
- 6** Press the **CURSOR UP ▲** or **DOWN ▼** buttons to select and adjust other Picture Menu controls.
- 7** When finished, press the **STATUS/EXIT** button to remove the menu from the TV's screen.

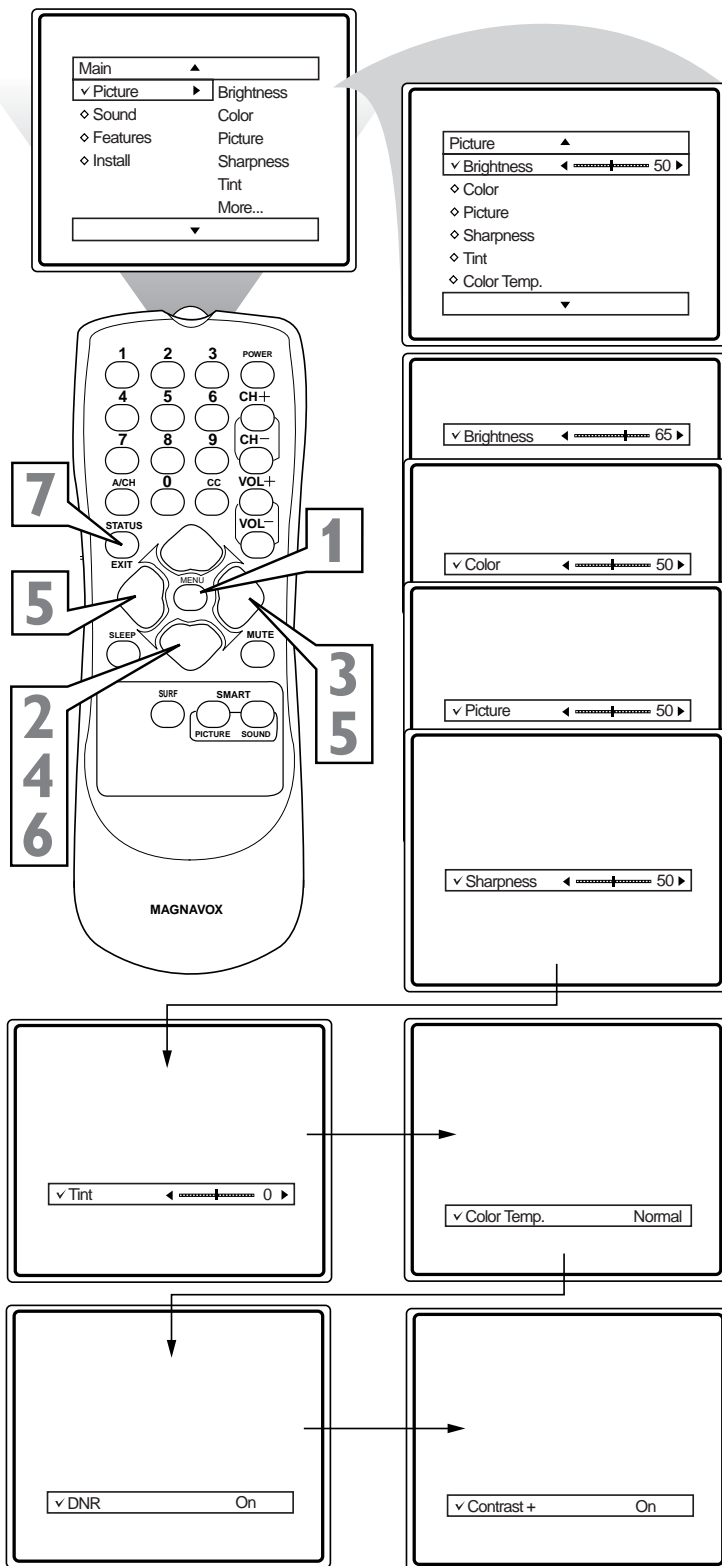

HELPFUL HINT

BRIGHTNESS: Press the ► or ◀ buttons until darkest parts of the picture are as bright as you prefer.

COLOR: Press the ► or ◀ buttons to add or eliminate color.

PICTURE: Press the ► or ◀ buttons until lightest parts of the picture show good detail.

SHARPNESS: Press the ► or ◀ buttons to improve detail in the picture.

TINT: Press the ► or ◀ buttons to obtain natural skin tones.

COLOR TEMP: Press the ► or ◀ buttons to select NORMAL, COOL, or WARM picture preferences. (NORMAL will keep the whites, white; COOL will make the whites, bluish; and WARM will make the whites, reddish.)

DNR: Press the ► or ◀ buttons to turn DNR ON or OFF. Dynamic Noise Reduction helps to eliminate "noise" from the picture.

Contrast +: Press the ► or ◀ buttons to turn Contrast + ON or OFF. When ON, this control will optimize the picture contrast for improved picture clarity.

HOW TO USE THE SOUND ADJUSTMENT CONTROLS



Besides the normal volume level control, your TV also has Treble Boost, Bass Boost, Balance, AVL (automatic volume leveler), and Sound (Stereo/Mono) controls.

- 1** Press the **MENU** button on the remote to display the on-screen menu.
- 2** Press the **CURSOR UP ▲** or **CURSOR DOWN ▼** button until the word **SOUND** is highlighted.
- 3** Press the **CURSOR RIGHT ►** button to display the **SOUND** menu features.
- 4** Press the **CURSOR UP ▲** or **CURSOR DOWN ▼** button to scroll the Sound menu features until the control you wish to change is highlighted (**Treble Boost**, **Bass Boost**, **Balance**, **AVL**, or **Sound**).
- 5** Press the **CURSOR RIGHT ►** or **LEFT ◀** button to turn the adjust or turn the control On or Off.
- 6** When finished, press the **STATUS/EXIT** button to remove the menu from the TV's screen.

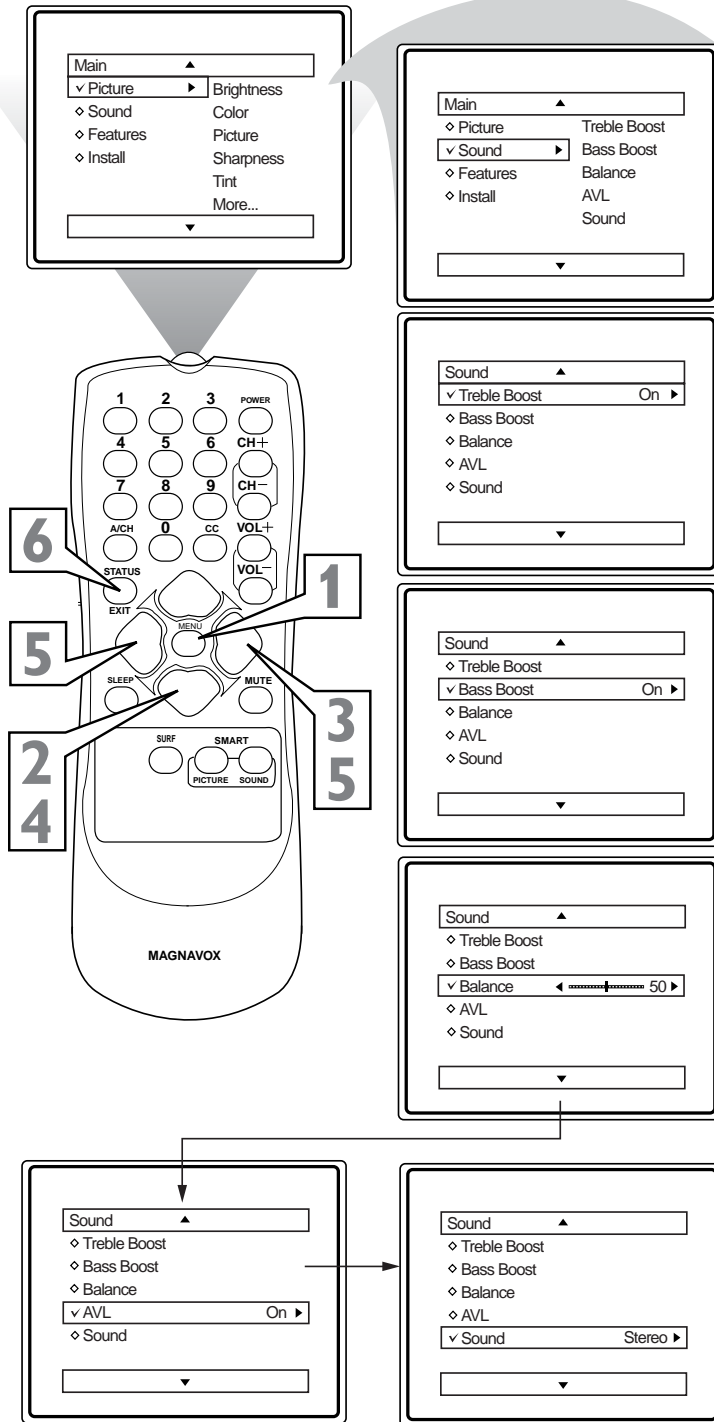

HELPFUL HINT

Treble Boost: Press the **►** or **◀** buttons to turn the control On or Off. When On, the control will enhance the high frequency sounds.

Bass Boost: Press the **►** or **◀** buttons to turn the control On or Off. When On, the control will enhance the low frequency sounds.

Balance: Press the **►** or **◀** buttons to adjust the level of sound coming from the left and right speakers.

AVL: (Auto Volume Leveler) Press the **►** or **◀** buttons to turn the control On or Off. When On, AVL will level out the sound being heard when sudden changes in volume occur during commercial breaks or channel changes.

Sound: Press the **►** or **◀** buttons to select between Stereo or Mono settings. Note: If Stereo is not present on a selected show and the TV is placed in the Stereo mode, the sound coming from the TV will remain in the Mono mode.



HOW TO USE THE FORMAT CONTROL (EXPAND 4:3)

Many times while watching movies from a DVD player the image is shown in "letter box" format. This is the format that is shown in movie theaters. When shown on a TV screen, the image will have areas of black on top and bottom of the screen.

- 1** Press the **MENU** button on the remote to display the on-screen menu.
- 2** Press the **CURSOR DOWN ▼** button until the word **FEATURES** is highlighted.
- 3** Press the **CURSOR RIGHT ►** button to display the **FEATURES** menu options (SmartLock or Format).
- 4** Press the **CURSOR DOWN ▼** button until the word **FORMAT** is highlighted.
- 5** Press the **CURSOR RIGHT ►** or **CURSOR LEFT ◀** buttons to select one of the two options 4:3 or Expand 4:3.
 - 4:3** - Standard format for the TV.
 - Expand 4:3** - Enlarges the picture to fill out the entire screen area, eliminating the "letter box" effect.
- 6** When finished, press the **STATUS/EXIT** button to remove the menu from the TV's screen.

Note: The Expand 4:3 format can also be activated using the **CURSOR UP ▲** or **DOWN ▼** buttons when the onscreen menu is not being displayed. Pressing these buttons will toggle the standard 4:3 format and the Expand 4:3 format.

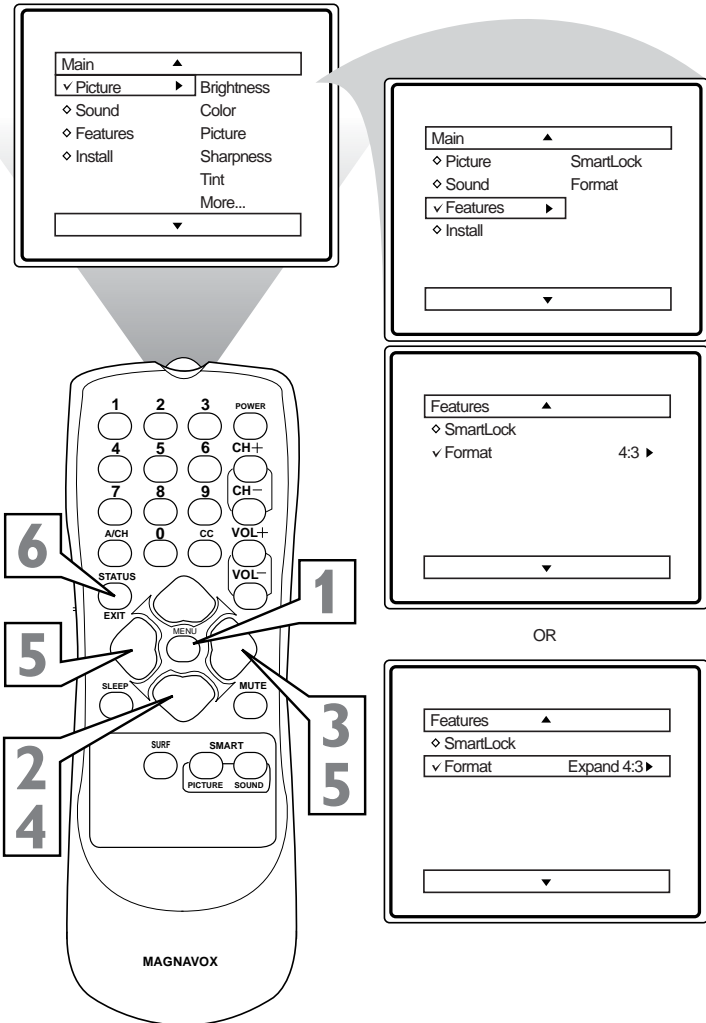

Some models refer to SmartLock as AutoLock, your TV may show AutoLock instead of SmartLock in the on-screen menu. These features are the same.



4:3



Expand 4:3

UNDERSTANDING THE SMARTLOCK™ CONTROLS



SmartLock (AutoLock) processes program content advisories from broadcasters. SmartLock™ can respond to the content advisories and block program content that may be found objectionable (such as offensive language, violence, sexual situations, etc.). This is a great feature to censor the type of viewing children may watch.

Over the next few pages you'll learn how to block channels and certain rated programming. Below is a brief explanation of some terms and ratings you will find in the SmartLock feature.

SmartLock™ offers various **BLOCKING** controls from which to choose:

Access Code: An Access Code must be set to prevent children from unblocking questionable programming.

Channel Block: Individual channels including the A/V inputs can be blocked.

Clear All: Allows you clear all channels being blocked from your viewing set with the Channel Block Control.

Block All: Allows you to block ALL channels and A/V inputs at one time.

Movie Ratings: Block programming based on ratings patterned by the Motion Pictures Association of America.

TV Ratings: Block programming based on standard TV ratings set by TV broadcasters.

To learn more about the Motion Picture Ratings and the TV Ratings, refer to the definitions listed on the columns to the right.

Press the **STATUS/EXIT** button twice to display the **SmartLock review screen**. This screen shows what is activated within the SmartLock settings.

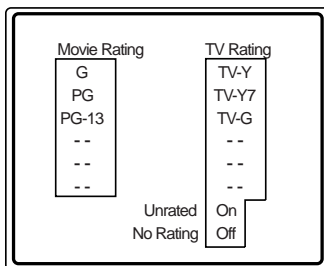

Some models refer to SmartLock as **AutoLock**, your TV may show **AutoLock** instead of **SmartLock** in the on-screen menu. These features are the same.

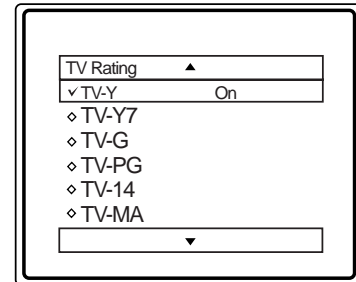
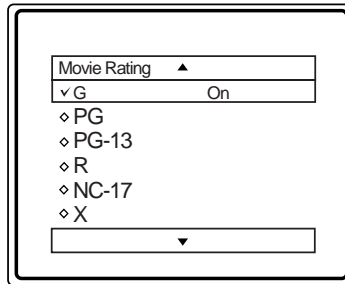

MOVIE RATINGS (MOTION PICTURE ASSOCIATION OF AMERICA)

G: General Audience - All ages admitted. Most parents would find this program suitable for all ages. This type of programming contains little or no violence, no strong language, and little or no sexual dialogue or situations.

PG: Parental Guidance Suggested - This programming contains material that parents may find unsuitable for younger children. It may contain one or more of the following: Moderate violence, some sexual situations, infrequent coarse language, or some suggestive dialogue.

PG-13: Parents Strongly Cautioned - This programming contains material that parents may find unsuitable for children under the age of 13. It contains one or more of the following: violence, sexual situations, coarse language, or suggestive dialogue.

R: Restricted - This programming is specifically designed for adults. Anyone under the age of 17 should only view this programming with an accompanying parent or adult guardian. It contains one or more of the following: intense violence, intense sexual situations, strong coarse language, or intensely suggestive dialogue.

NC-17: No one under the age of 17 will be admitted. - This type of programming should be viewed by adults only. It contains graphic violence, explicit sex, or crude indecent language.

X: Adults Only - This type of programming contains one or more of the following: very graphic violence, very graphic and explicit or indecent sexual acts, very coarse and intensely suggestive language.

TV PARENTAL GUIDELINES (TV BROADCASTERS)

TV Y **TV-Y - (All children** -- This program is designed to be appropriate for all children.) Designed for a very young audience, including children ages 2-6. This type of programming is not expected to frighten younger children.

TV Y7 **TV-Y7 - (Directed to Older Children** -- This program is designed for children age 7 and above.) It may be more appropriate for children who have acquired the development skills needed to distinguish between make-believe and reality. This programming may include mild fantasy and comic violence (FV).

TV G **TV-G - (General Audience** -- Most parents would find this program suitable for all ages.) This type of programming contains little or no violence, no strong language, and little or no sexual dialogue or situations.

TV PG **TV-PG - (Parental Guidance Suggested** -- This program contains material that parents may find unsuitable for younger children.) This type of programming contains one or more of the following: Moderate violence (V), some sexual situations (S), infrequent coarse language (L), or some suggestive dialogue (D).

TV 14 **TV-14 - (Parents Strongly Cautioned** -- This program contains some material that many parents would find unsuitable for children under 14 years of age.) This type of programming contains one or more of the following: intense violence (V), intense sexual situations (S), strong coarse language (L), or intensely suggestive dialogue (D).

TV MA **TV-MA - (Mature Audience Only** -- This program is specifically designed to be viewed by adults and therefore may be unsuitable for children under 17.) This type of programming contains one or more of the following: graphic violence (V), explicit sexual situations (S), or crude indecent language (L).



SETTING UP A SMARTLOCK™ ACCESS CODE

Over the next few pages you'll learn how to block channels and get a better understanding of the rating terms for certain programming.

First, let's start by learning how to set a personal access code:

- 1** Press the **MENU** button on the remote to display the on-screen menu.
- 2** Press the **CURSOR UP ▲** or **DOWN ▼** button until the word **FEATURES** is highlighted.
- 3** Press the **CURSOR RIGHT ►** button to display the **FEATURES** menu options.
- 4** Press the **CURSOR UP ▲** or **DOWN ▼** button until the word **SmartLock** are highlighted.
- 5** Press the **CURSOR RIGHT ►** button. The screen will read, "ACCESS CODE - - - -."
- 6** Using the **NUMBERED** buttons, enter **0, 7, 1, 1**. "XXXX" appears on the Access Code screen as you press the numbered buttons. "INCORRECT CODE" will appear on the screen, and you will need to enter **0, 7, 1, 1** again.
- 7** The screen will ask you to enter a "New Code." Enter a "new" 4 digit code using the **NUMBERED** buttons. The screen will then ask you to **CONFIRM** the code you just entered. Enter your new code again. "XXXX" will appear when you enter your new code and then display the SmartLock menu options.

Proceed to the next page to learn more...

Some models refer to SmartLock as AutoLock, your TV may show AutoLock instead of SmartLock in the on-screen menu. These features are the same.

HELPFUL HINT

Parents - it isn't possible for your child to unblock a channel without knowing your access code or changing it to a new one. If your code changes, and you didn't change it, then you know it's been altered by someone else and blocked channels have been viewed.

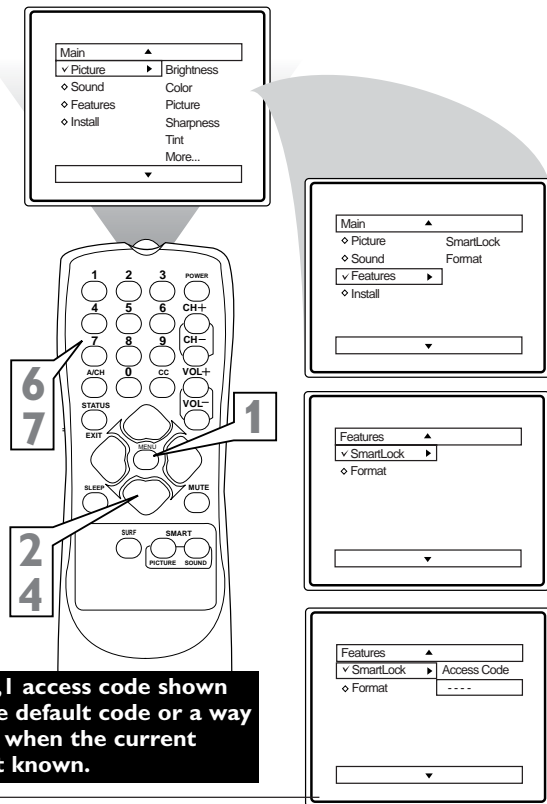

NOTE: The 0,7,1,1 access code shown on this page is the default code or a way to reset the code when the current access code is not known.

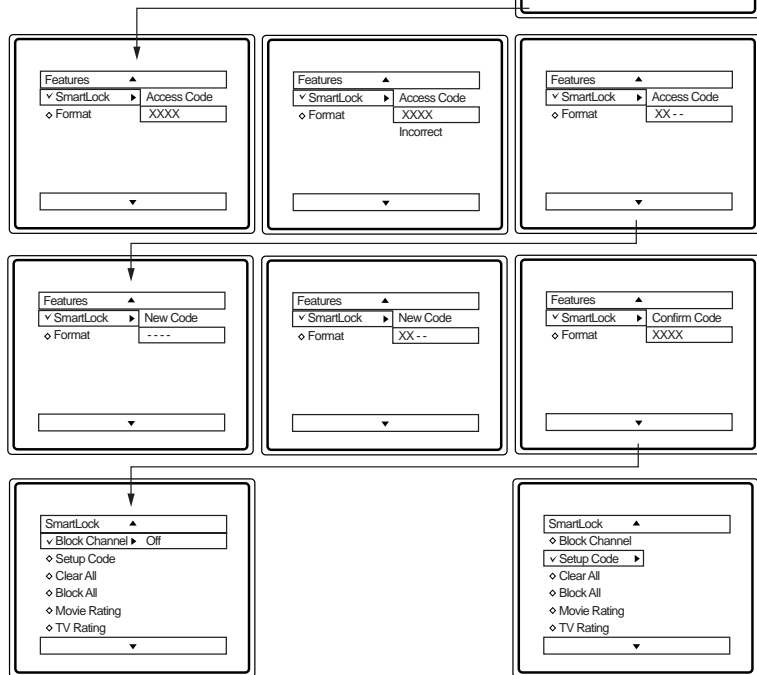

How to BLOCK CHANNELS



After your personal access code has been set (see previous page), you are now ready to select the channels you want to block out or censor.

- 1** Press the **NUMBERED (or CH+ or CH-)** buttons to tune the channel you wish to block or censor.
- 2** Press the **MENU** button on the remote to show the on-screen menu.
- 3** Press the **CURSOR UP ▲ or DOWN ▼** button until the word **FEATURES** is highlighted.
- 4** Press the **CURSOR RIGHT ►** button to display the **FEATURES** menu options.
- 5** Press the **CURSOR UP ▲ or DOWN ▼** button until the words **SmartLock** are highlighted.
- 6** Press the **CURSOR RIGHT ►** button. **"ACCESS CODE"** will appear on the screen.
- 7** Enter the correct access code number. **"XXXX"** shows on the Access Code display as you press the **NUMBERED** buttons. The SmartLock menu options will be displayed.
- 8** Press the **CURSOR UP ▲ or DOWN ▼** buttons until the words **BLOCK CHANNELS** are highlighted.
- 9** Press the **CURSOR RIGHT ►** button to turn blocking **ON** or **OFF** for that channel. When **ON** is selected the channel will be blocked.
- 10** Press the **CH + or -** buttons to select other channels you wish to block. Repeat step 9 to block the new channel.

Some models refer to SmartLock as AutoLock, your TV may show AutoLock instead of SmartLock in the on-screen menu. These features are the same.

HELPFUL HINT

If you tune to a blocked channel and enter your Access Code to view the channel, ALL blocked channels will be viewable until the TV has been turned off. When the TV is powered back ON, the previously blocked channels will be blocked again.

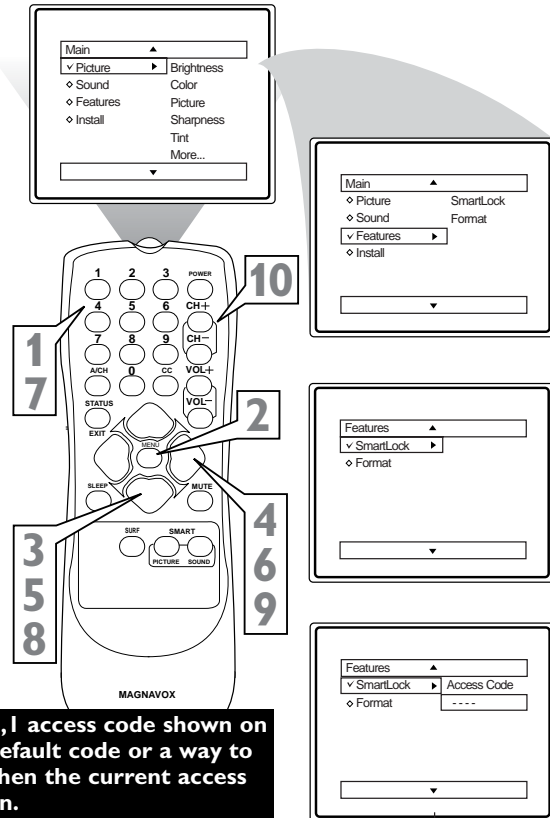

NOTE: The 0,7,1,1 access code shown on this page is the default code or a way to reset the code when the current access code is not known.

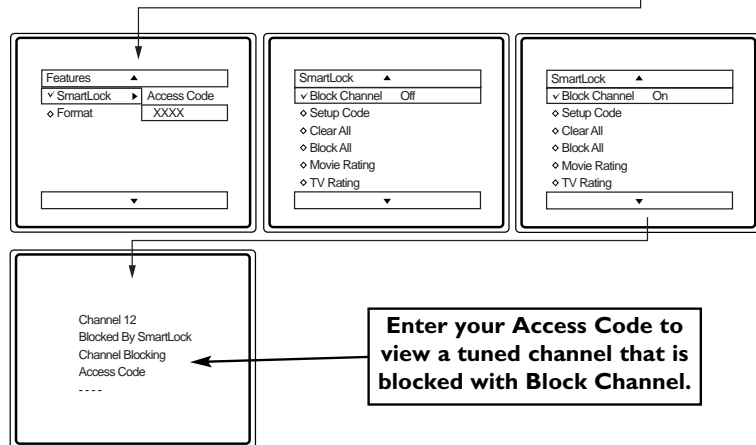

Enter your Access Code to view a tuned channel that is blocked with Block Channel.



HOW TO CLEAR ALL BLOCKED CHANNELS AT THE SAME TIME

After blocking specific channels there may come a time when you want to clear all the channels so they can be viewed. The following steps explain how to CLEAR ALL blocked channels.

- 1** Press the **MENU** button on the remote to show the on-screen menu.
- 2** Press the **CURSOR UP ▲** or **DOWN ▼** button until the word **FEATURES** is highlighted.
- 3** Press the **CURSOR RIGHT ►** button to display the **FEATURES** menu options.
- 4** Press the **CURSOR UP ▲** or **DOWN ▼** button until the words **SmartLock** are highlighted.
- 5** Press the **CURSOR RIGHT ►** button.
- 6** Enter the correct access code number. "XXXX" shows on the Access Code display as you press the **NUMBERED** buttons. **SmartLock** menu options will be displayed.
- 7** Press the **CURSOR UP ▲** or **DOWN ▼** buttons until the words **CLEAR ALL** are highlighted.
- 8** Press the **CURSOR RIGHT ►** button to clear all blocked channels. The Clear All option will read, "Cleared."
- 9** When finished, press the **STATUS/EXIT** button to remove the menu from the TV's screen.

Some models refer to **SmartLock** as **AutoLock**, your TV may show **AutoLock** instead of **SmartLock** in the on-screen menu. These features are the same.

HELPFUL HINT

If you tune to a blocked channel and enter your Access Code to view the channel, ALL blocked channels will be viewable until the TV is powered OFF and then turned back ON. When the TV is powered back ON, the previously blocked channels will be blocked again.

CLEAR ALL will not work with the Movie and TV Ratings. These options must be reset individually.

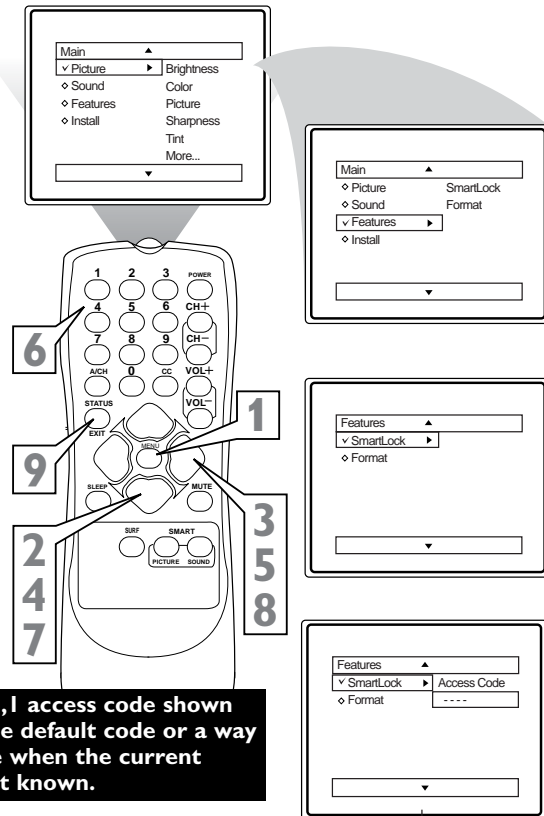

NOTE: The 0,7,1,1 access code shown on this page is the default code or a way to reset the code when the current access code is not known.

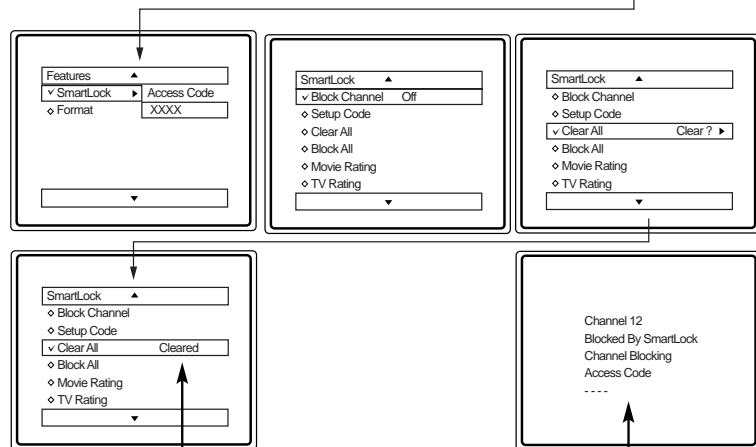

The **Clear All** option when activated will unblock ALL blocked channels. It will not affect programming blocked by the **Movie** or **TV Rating** options.

Or, enter your **Access Code** to view a tuned channel that is blocked with **Block Channel**.

HOW TO BLOCK ALL CHANNELS AT THE SAME TIME



There may come a time when you want to Block All the television's channels. Maybe you don't want your children to watch TV for a given period time. With the Block All control, ALL available channels (including the A/V Inputs) can be set to be blocked at the same time.

- 1** Press the **MENU** button on the remote to show the on-screen menu.
- 2** Press the **CURSOR UP ▲** or **DOWN ▼** button until the word **FEATURES** is highlighted.
- 3** Press the **CURSOR RIGHT ►** button to display the FEATURES menu options.
- 4** Press the **CURSOR UP ▲** or **DOWN ▼** button until the words **SmartLock** are highlighted.
- 5** Press the **CURSOR RIGHT ►** button.
- 6** Enter the correct access code number. "XXXX" shows on the Access Code display as you press the **NUMBERED** buttons. SmartLock menu options will be displayed.
- 7** Press the **CURSOR UP ▲** or **DOWN ▼** buttons until the words **BLOCK ALL** are highlighted.
- 8** Press the **CURSOR RIGHT ►** button to turn Block All ON or OFF. When ON is selected, ALL available channels will be blocked.
- 9** When finished, press the **STATUS/EXIT** button to remove the menu from the screen.

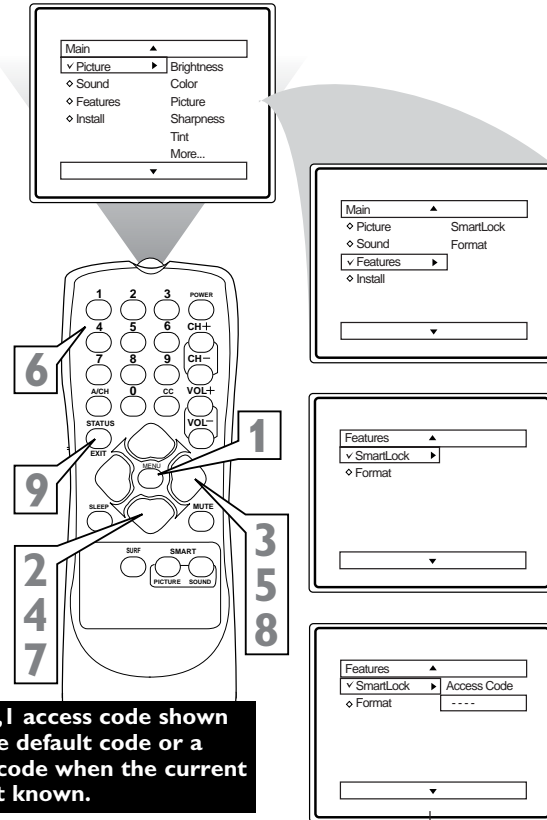

NOTE: The 0,7,1,1 access code shown on this page is the default code or a way to reset the code when the current access code is not known.

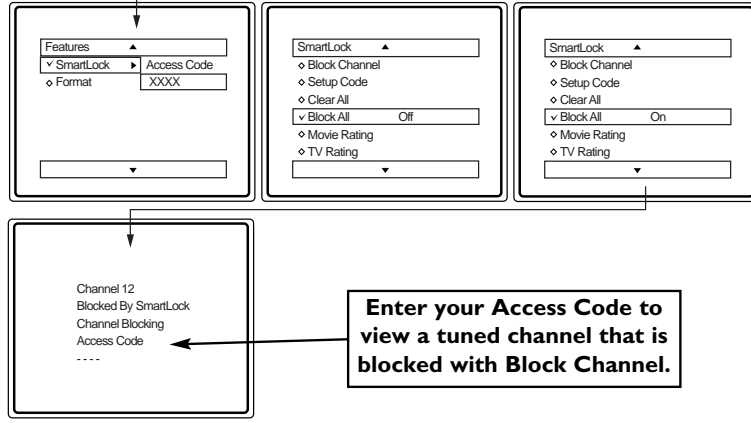

Enter your Access Code to view a tuned channel that is blocked with Block Channel.

Some models refer to SmartLock as AutoLock, your TV may show AutoLock instead of SmartLock in the on-screen menu. These features are the same.

HELPFUL HINT
If you tune to a blocked channel and enter your Access Code to view the channel, ALL blocked channels will be viewable until the TV has been turned off. When the TV is powered back ON, the previously blocked channels will be blocked again.



BLOCKING PROGRAMS BASED ON MOVIE RATINGS

There are two types of program ratings within the SmartLock™ feature. One is based on the Movie Industry ratings while the other is based on the TV Industry ratings. Both can be used to block or censor programming that has been rated in either manner.

Let's first look at the Movie Rating options of SmartLock™:

- 1** Press the **MENU** button on the remote to display the on-screen menu.
- 2** Press the **CURSOR UP ▲** or **DOWN ▼** button until the word **FEATURES** is highlighted.
- 3** Press the **CURSOR RIGHT ►** button to display the FEATURES menu options.
- 4** Press the **CURSOR UP ▲** or **DOWN ▼** button until SmartLock is highlighted.
- 5** Press the **CURSOR RIGHT ►** button. The screen will prompt you for your Access Code.
- 6** Using the **NUMBERED** buttons on the remote, enter your 4 digit Access Code. The SmartLock menu options will be displayed.
- 7** Press the **CURSOR UP ▲** or **DOWN ▼** button to highlight the words **MOVIE RATINGS**.
- 8** Press the **CURSOR RIGHT ►** button to display the **MOVIE RATINGS** options (G, PG, PG-13, R, NC-17, or X).
- 9** Press the **CURSOR UP ▲** or **DOWN ▼** button to highlight any of the Movie Ratings options. When highlighted, all these options can be turned **ON** (which will allow blocking) or **OFF** (which will allow viewing).
- 10** Use the **CURSOR RIGHT ►** button on the remote to turn the rating option ON or OFF.

Some models refer to SmartLock as AutoLock, your TV may show AutoLock instead of SmartLock in the on-screen menu. These features are the same.

HELPFUL HINT

When a rating is set to block, all higher ratings will be automatically blocked as well. (Example: If the the PG-13 rating is set to block, the R, NC-17, and X ratings will also be blocked.)

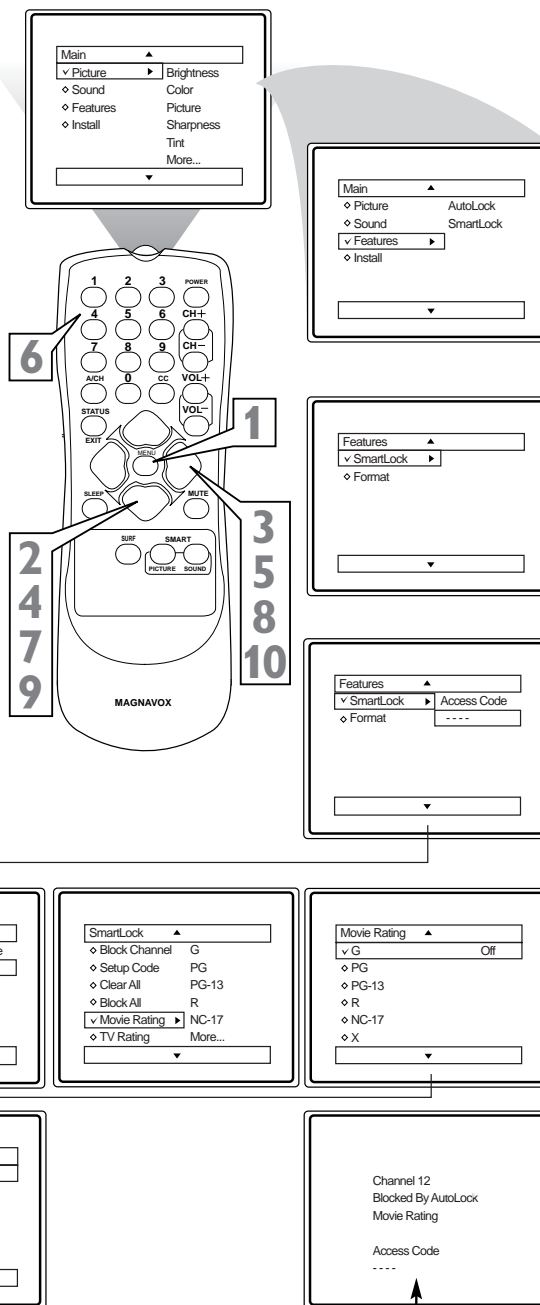

NOTE: The 0,7,1,1 access code shown on this page is the default code or a way to reset the code when the current access code is not known.

To view a program blocked by the Movie Rating options, enter your 4 digit access code. This will disable all blocked Movie Ratings until the TV is powered off and on again. Then the blocking options will be restored.

BLOCKING PROGRAMS BASED ON TV RATINGS



This portion of the SmartLock™ features cover program ratings based on the TV Industry rating system. This is known as TV Ratings within SmartLock™.

After selecting the SmartLock™ feature and entering your personal access code, the SmartLock™ options screen appears;

1 Scroll the menu using the **CURSOR UP ▲** or **DOWN ▼** buttons until the words **TV RATINGS** are highlighted.

2 Press the **CURSOR RIGHT ►** button to display the **TV Ratings (TV-Y, TV-Y7, TV-G, TV-PG, TV-14, or TV-MA)**. When highlighted, the TV-Y and TV-G can be turned **ON** (which will allow blocking) or **OFF** (which will allow viewing) of these rated programs.

The ratings of TV-Y7, TV-PG, TV-14, or TV-MA can be customized to block V (violence), FV (fantasy violence), S (sexual situations), L (coarse language), or D (suggestive dialogue).

3 Press the **CURSOR UP ▲** or **DOWN ▼** button to highlight the desired rating.

4 Press the **CURSOR RIGHT ►** button on the remote to turn the TV-Y or TV-G rating ON or OFF. Or, press the **CURSOR RIGHT ►** button to enter the sub-menus for the TV-Y7, TV-PG, TV-14, or TV-MA ratings.

5 If the TV-Y7, TV-PG, TV-14, or TV-MA sub-menu is accessed, press the **CURSOR UP ▲** or **CURSOR DOWN ▼** button to select one of the options (Block All, V, S, L, D, or FV).

6 Press the **CURSOR RIGHT ►** button on the remote to turn the option ON or OFF.

Some models refer to SmartLock as AutoLock, your TV may show AutoLock instead of SmartLock in the on-screen menu. These features are the same.

To view a program blocked by the TV Rating options, enter your 4 digit access code. This will disable all blocked TV Ratings until the TV is powered off and on again. Then the blocking options will be restored.

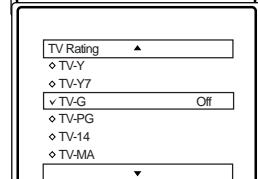
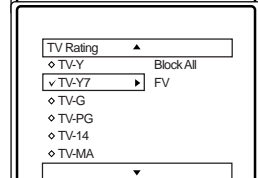
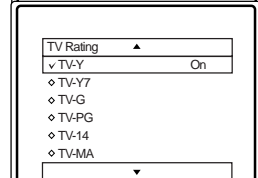
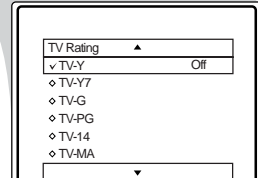
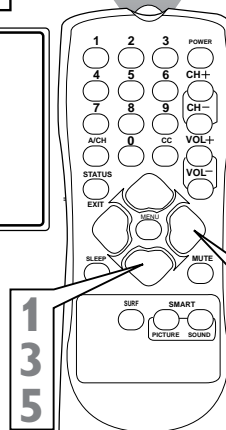
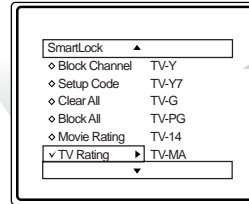
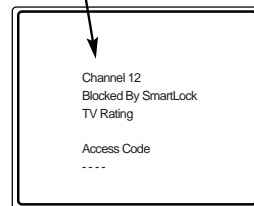

NOTE: The 0,7,1,1 access code shown on this page is the default code or a way to reset the code when the current access code is not known.

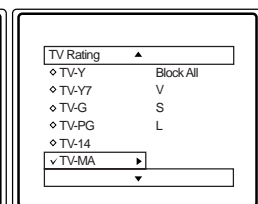
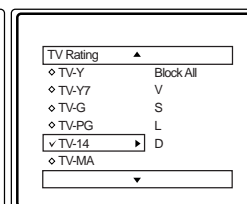
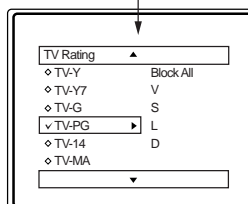

TV Ratings and Rating Sub-Menus
When a TV Rating is selected to block, ALL higher ratings will be blocked also.

TV-Y - (All children -- This program is designed to be appropriate for all children.) Designed for a very young audience, including children ages 2-6. This type of programming is not expected to frighten younger children.

TV-Y7 - (Directed to Older Children -- This program is designed for children age 7 and above.) It may be more appropriate for children who have acquired the development skills needed to distinguish between make-believe and reality. This programming may include mild fantasy and comic violence (FV).

TV-G - (General Audience -- Most parents would find this program suitable for all ages.) This type of programming contains little or no violence, no strong language and little or no sexual dialogue or situations.

TV-PG - (Parental Guidance Suggested -- This program contains material that parents may find unsuitable for younger children.) This type of programming contains one or more of the following: some suggestive dialogue (D), infrequent coarse language (L), some sexual situations (S), or moderate violence (V).

TV-14 - (Parents Strongly Cautioned -- This program contains some material that many parents would find unsuitable for children under 14 years of age.) This type of programming contains one or more of the following: intensely suggestive dialogue (D), strong coarse language (L), intense sexual situations (S), or intense violence (V).

TV-MA - (Mature Audience Only -- This program is specifically designed to be viewed by adults and therefore may be unsuitable for children under 17.) This type of programming contains one or more of the following: crude indecent language (L), explicit sexual situations (S), or graphic violence (V).



OTHER SMARTLOCK™ BLOCKING OPTIONS

SmartLock™ offers the viewer other blocking features as well. With these Blocking Options, the censoring can be turned ON or OFF.

- 1** Press the **MENU** button on the remote to show the on-screen menu.
- 2** Press the **CURSOR UP ▲** or **DOWN ▼** button until the word **FEATURES** is highlighted.
- 3** Press the **CURSOR RIGHT ►** button to display the FEATURES menu options.
- 4** Press the **CURSOR UP ▲** or **DOWN ▼** button until the words SmartLock are highlighted.
- 5** Press the **CURSOR RIGHT ►** button.
- 6** Enter the correct access code number. "XXXX" shows on the Access Code display as you press the **NUMBERED** buttons. SmartLock menu options will be displayed.
- 7** Press the **CURSOR UP ▲** or **DOWN ▼** buttons until the words **BLOCKING OPTIONS** are highlighted.
- 8** Press the **CURSOR RIGHT ►** button to display the **Blocking Options (BLOCKING, UNRATED, or NO RATING)** menu.
- 9** Press the **CURSOR UP ▲** or **DOWN ▼** buttons to highlight the desired feature.
- 10** When highlighted, each feature can be turned **ON** or **OFF** using the **CURSOR RIGHT ►** or **LEFT ◀** buttons on the remote.

Some models refer to SmartLock as AutoLock, your TV may show AutoLock instead of SmartLock in the on-screen menu. These features are the same.

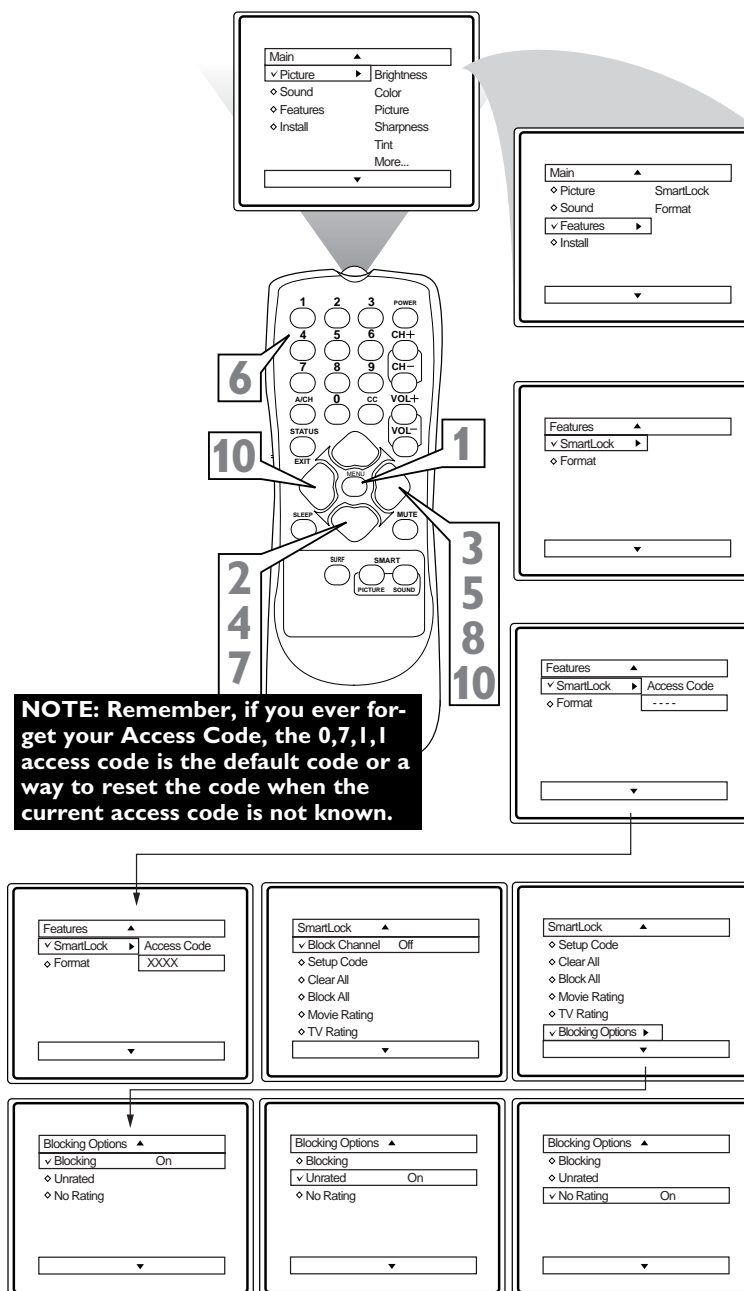

BLOCKING OPTIONS:

BLOCKING: This is what might be called the “master switch” for SmartLock™. When in the ON position, ALL blocking/censoring will take place. When in the OFF position, ALL blocking is disabled.

UNRATED: ALL unrated programs based on the Movie Ratings or Parental (TV) Guidelines can be blocked if this feature is set to ON and the BLOCKING feature is set to OFF.

NO RATING: ALL programming with NO content advisory data can be blocked if this feature is set to ON and the BLOCKING feature is set to OFF.

SETTING THE SLEEPTIMER CONTROL



Have you ever fallen asleep in front of the TV only to have it wake you up at two in the morning with a test pattern screeching in your ears? Well, your TV can save you all that trouble by automatically turning itself off.

- 1** Press the **SLEEP** button on the remote control and the SLEEP timer display will appear on the screen.
- 2** Press the **SLEEP** button repeatedly to pick the amount of time (15, 30, 45, 60, 90, 120, 180, or 240 minutes) before the TV will turn itself off.

An on-screen count down will appear during the last minute before the TV shuts itself off.

HELPFUL HINT

The on-screen menu will time out and disappear from the screen when you finish, or you can press the STATUS/EXIT button to clear the menu from the screen.

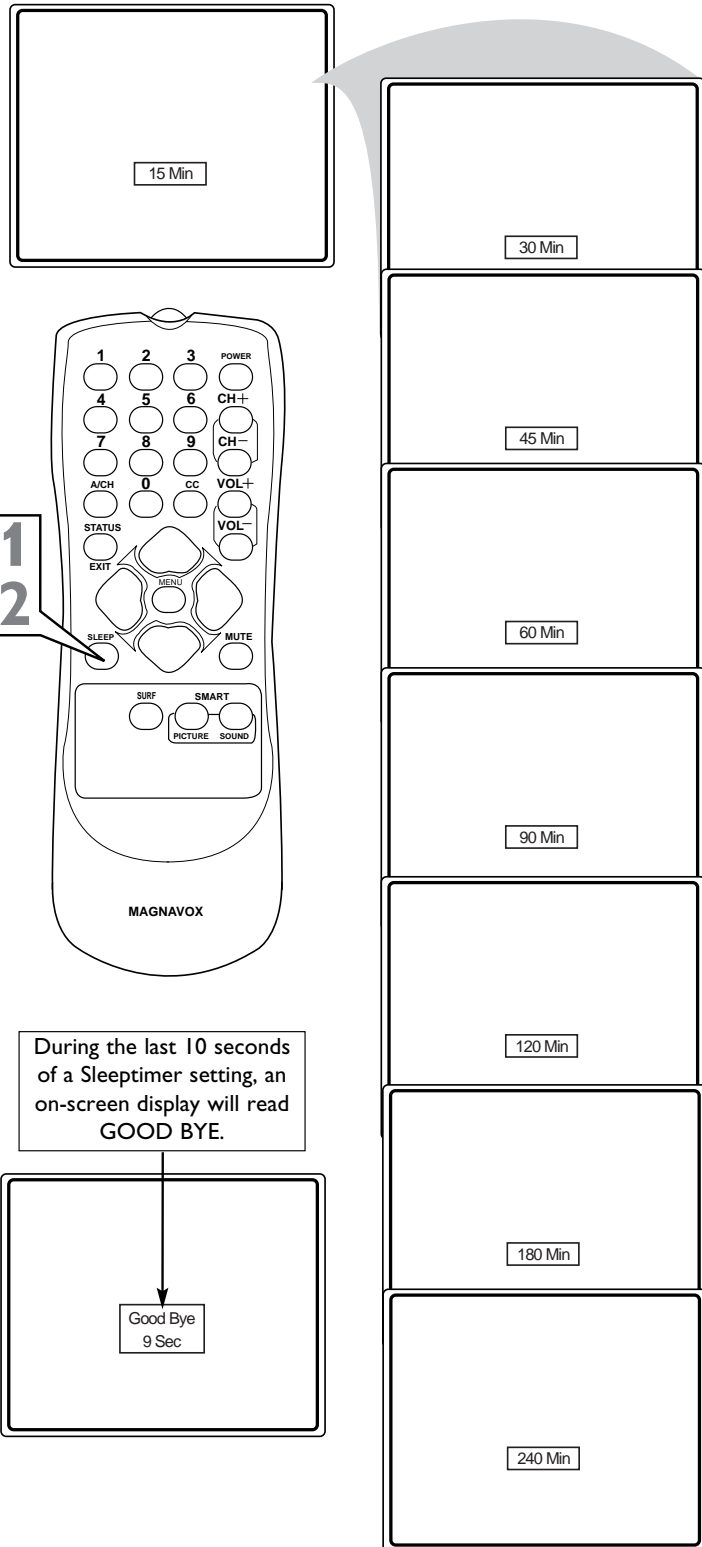



HOW TO USE THE CLOSED CAPTIONING CONTROL

Closed Captioning (CC) allows you to read the voice content of television programs on the TV screen. Designed to help the hearing impaired, this feature uses on-screen "text boxes" to show dialogue and conversations while the TV program is in progress.

- 1** Press the **CC** button on the remote to display the current Closed Caption setting.
- 2** Press the **CC** button repeatedly to choose from the four Closed Caption options (CC Off, CC 1, CC 2, CC Mute). Dialogue (and descriptions) for the action on the captioned TV program will appear on-screen if the tuned program is broadcasting CC information.
- 3** When finished, press the **STATUS /EXIT** button to remove the menu from the TV's screen or let the option time out and disappear from the TV screen.

HELPFUL HINT

Not all TV programs and product commercials are made with Closed Caption (CC) information included. Neither are all Closed Caption modes (CC1, or CC2) necessarily being used during the transmission of a closed caption program. Refer to your area's TV program listings for the stations and times of Closed Caption shows.

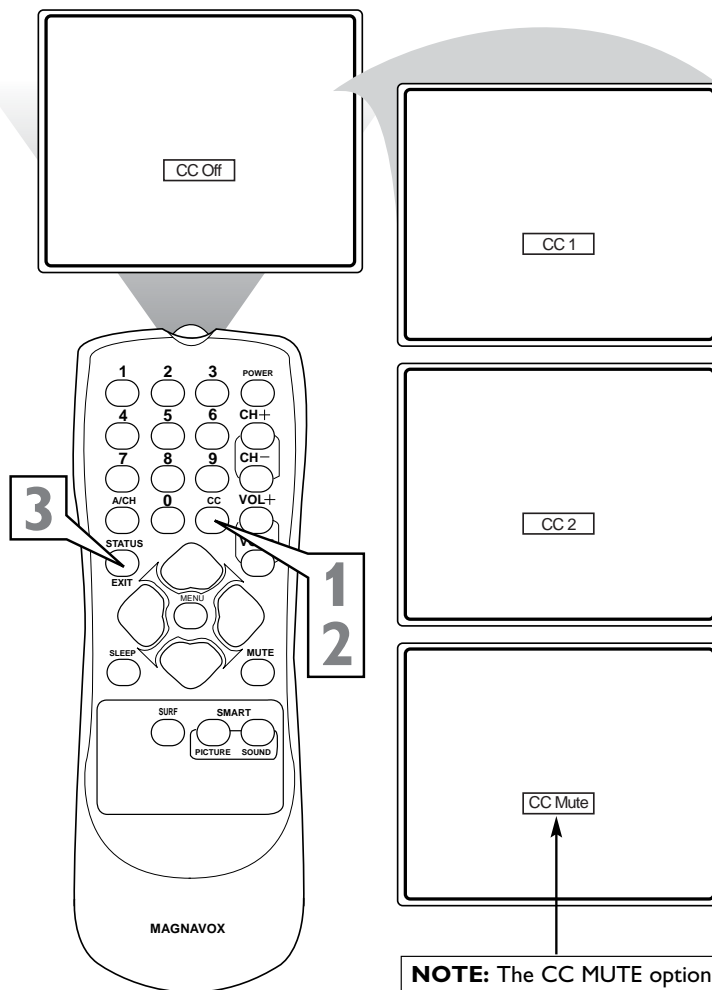

NOTE: The CC MUTE option can be used to set the TV to turn the Closed Caption mode "ON" whenever the MUTE button on the remote is pressed. This activates the CC1 option.

SETTING THE SMARTPICTURE™ CONTROL



Whether you're watching a movie or a sporting event, your TV has automatic video control settings matched for your current program source or content. The SmartPicture™ feature quickly resets your TV's video controls for a number of different types of programs and viewing conditions you may have in your home. Each SmartPicture™ setting is preset at the factory to automatically adjust the TV's Brightness, Color, Picture, Sharpness, Tint, Color Temperature, DNR, and Contrast+ levels.

1 Press the **SMART PICTURE** button on the remote control. The current SmartPicture setting will appear in the middle of the screen.

2 Press the **SMART PICTURE** button repeatedly to select either **PERSONAL**, **MOVIES**, **SPORTS**, **WEAK SIGNAL**, or **MULTIMEDIA** picture settings.

Note: The **PERSONAL** setting is the setting that you setup using the **PICTURE** options within the on-screen menu. This is the only SmartPicture setting that can be changed. All other settings are setup at the factory during the time of production.

MOVIES - Preset picture options for watching Video Tapes, or DVDs.

SPORTS - Preset picture options for watching sporting events.

WEAK SIGNAL - Preset picture options for watching programs where the reception is not at its best.

MULTIMEDIA - Preset picture options for use with video gaming.

Some models refer to SmartPicture as AutoPicture. These features are the same.

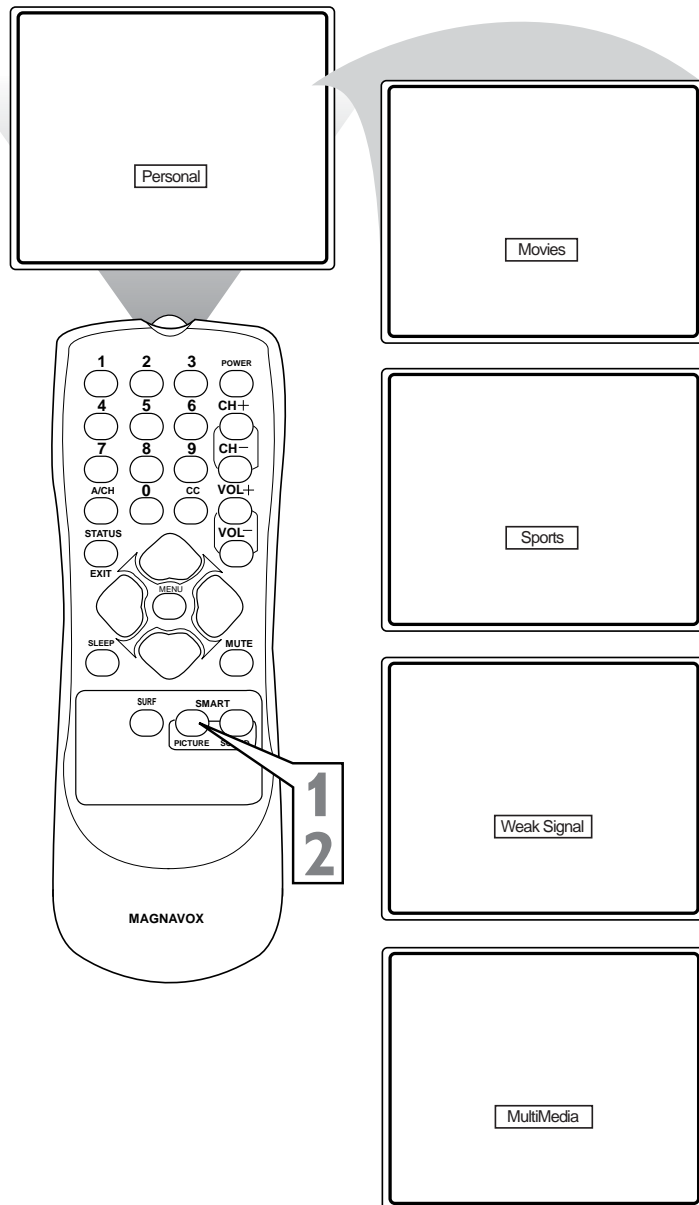



SETTING THE SMARTSOUND™ CONTROL

The SmartSound™ feature allows the listener to select between four different factory set sound options. Personal (which can be set by the user), Theatre (for movie viewing), Music (for musical type programming) and Voice (when the program is mainly dialogue). These settings affect the Sound menu's Bass, Treble, AVL, and Incredible Surround controls.

To select any of the options follow the directions below.

1 Press the **SMART SOUND** button on the remote control. The current Auto Sound setting will appear in the middle of the screen.

2 Press the **SMART SOUND** button repeatedly to toggle between the four settings.

Note: Only the **PERSONAL** control can be changed by the viewer. This changes the settings in the main on-screen menu's sound controls.

THEATRE - Preset sound options for watching movies.

MUSIC - Preset sound options for musical programming where there is little dialogue.

VOICE - Preset sound options for programming where heavy dialogue is present.

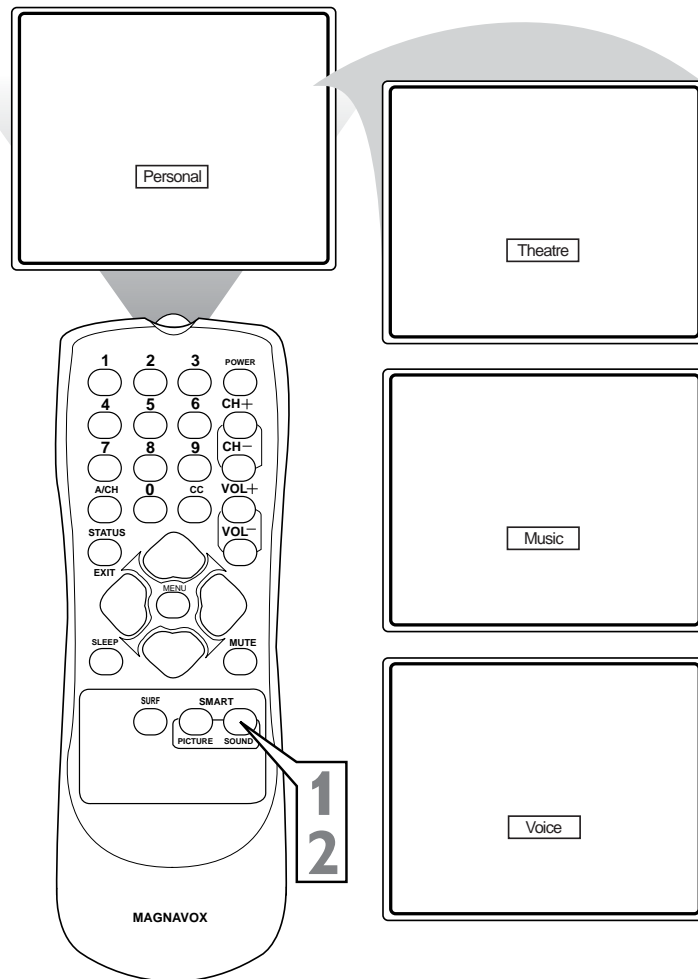

Some models refer to SmartSound as AutoSound. These features are the same.

HOW TO USE THE ALTERNATE CHANNEL (A/CH) BUTTON



Your remote control has an Alternate Channel button that allows you to toggle between the current and previous button. For instance, if you are watching two games on TV, you can enter the channel numbers once and flip between the two channels with the touch of only one button.

After entering the two channels numbers, so that one is the last viewed channel and the other is the current channel, follow the step below.

- 1 Press the A/CH button** on the remote control. The channels will toggle between the current channel and the last viewed channel.

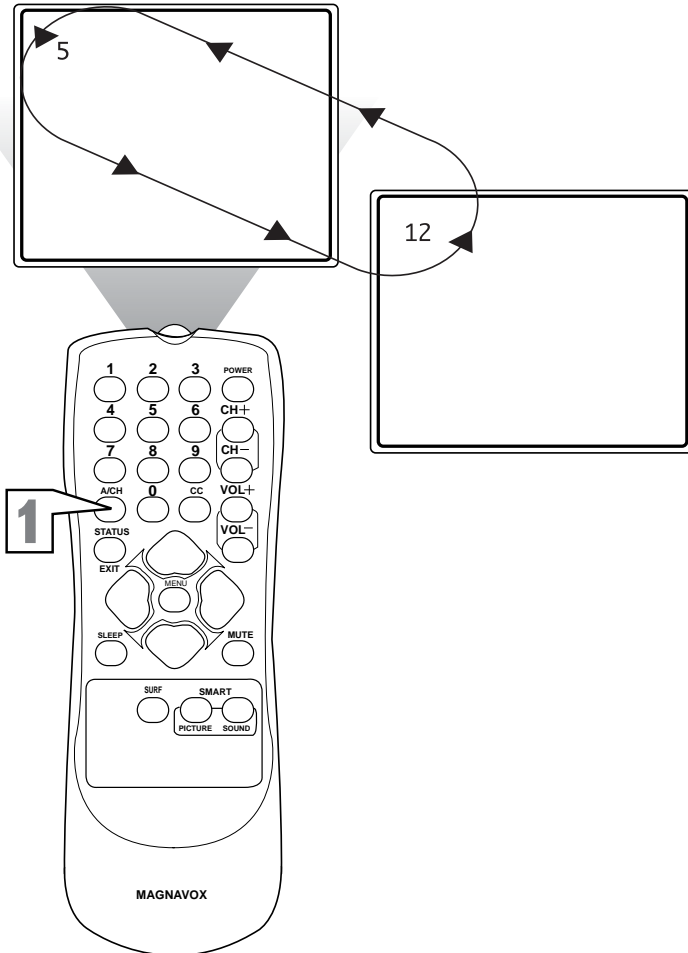



TROUBLESHOOTING

No Power

- Check the TV power cord. Unplug the TV, wait 10 seconds, then reinsert the plug into the outlet and push the POWER button again.
- Check that the outlet is not on a wall switch.
- Be sure the fuse is not blown on the AC power strip, if one is being used.

No Picture

- Check antenna connections. Are they properly secured to the TV's ANT 75Ω plug?
- Check the TUNER MODE control for the correct tuner setting.
- Try running the Auto Program feature to find all available channels.
- Press the AV button on the remote to make sure the correct signal source is selected (FRONT or Current Channel).

No Sound

- Check the VOLUME buttons.
- Check the MUTE button on the remote control.
- If you're attempting to hook up auxiliary equipment, check the audio jack connections located on the front of the TV.

Remote Does Not Work

- Check the batteries. If necessary, replace them with 2 AA Heavy Duty (Zinc Chloride) or Alkaline batteries.
- Clean the remote control and the remote control sensor window on the TV.
- Check the TV power cord. Unplug the TV, wait 10 seconds, then reinsert the plug into the outlet and push the POWER button again.
- Be sure the fuse is not blown on the AC power strip, if one is being used.
- Check to be sure the TV outlet is not on a wall switch.

TV Displays Wrong Channel or No Channels Above 13

- Repeat channel selection.
- Add the desired channel numbers (using the CHANNEL EDIT control) into the TV's memory.
- Check to be sure the TUNER MODES are set to the CABLE option and run the Auto Program feature to find all available channels.



WARNING Concerning Stationary Images on the TV Screen:

Do not leave stationary or letterbox images on screen for extended periods of time. This can cause uneven picture-tube aging.

Normal use of the TV should involve the showing of pictures that contain constantly moving and changing images that fill the screen. Be careful not to leave nonmoving images on screen for extended periods of time, or to display the same images on screen too frequently, because subtle ghost images can be left on the picture tubes. Sources of stationary images may be DVD disks, laser disks, video games, CD-i disks, videotapes, digital television boxes, broadcast channels, cable channels, satellite channels, and others. **Here are some examples of stationary images (this is not an all-inclusive list; you may encounter others in your viewing):**

- **DVD menus**—listings of DVD disk content
- **Letterbox black bars**—shown at the top and bottom of the TV screen when a wide screen (16:9) movie is viewed on a TV with standard (4:3) aspect ratio.
- **Video-game images and scoreboards**
- **Television station logos**—present a problem if they are bright and stationary; moving or low-contrast graphics are less likely to cause uneven aging of the picture tube
- **Stock-market tickers**—presented at the bottom of the TV screen
- **Shopping channel logos and pricing displays**—bright and shown constantly or repeatedly in the same location on the TV screen.

PLACEMENT OF THE TV

- To avoid cabinet warping, cabinet color changes, and increased chance of set failure, do not place the TV where temperatures can become excessively hot; for example, in direct sunlight or near a heating appliance.
- Be sure to allow a free flow of air to and from the perforated back cover of the set.

CLEANING

- To avoid possible shock hazard, be sure the TV is unplugged from the electrical outlet before cleaning.
- Regularly dust the TV with a dry, nonscratching duster to keep the TV clean.
- When cleaning the TV, take care not to scratch or damage the screen surface. Avoid wearing jewelry or using anything abrasive. Do not use household cleaners. Wipe the front screen with a clean cloth dampened with water. Use even, easy, vertical strokes when cleaning.
- Gently wipe the cabinet surfaces with a clean cloth or sponge dampened in a solution of cool, clear water and a mild soap or detergent. Use a clean, dry cloth to dry the wiped surfaces.
- Occasionally vacuum the ventilation holes or slots in the back cover of the set.
- Never use thinners, insecticide sprays, or other chemicals on or near the cabinet, as they might cause permanent marring of the cabinet finish.



GLOSSARY OF TERMS

Auto Programming • The procedure of adding or deleting channel numbers into the Television's memory circuits. In this format the Television "remembers" only the locally available or desired channel numbers and skips over any unwanted channel numbers.

Coaxial Cable • A single solid antenna wire normally matched with a metal plug (F-type) end connector that screws (or pushes) directly onto a 75 Ohm input found on the Television or VCR.

Closed Caption • Broadcast standard which allows you to read the voice content of television programs on the TV screen. Designed to help the hearing impaired this feature uses on-screen "text boxes" to show dialogue and conversations while the TV program is in progress.

Side Audio/Video Inputs • Located on the side of the TV these connectors (phono type plug) are used for the input of audio and video signals. Designed for easy use with VCRs or cameras.

On Screen Displays (OSD) • Refers to the wording or messages generated by the television (or VCR) to help the user with specific feature controls (color adjustment, programming, etc.).

Menu • An on-screen listing of feature controls shown on the Television screen that are made available for user adjustments.

Remote Sensor Window • A window or opening found on the Television control panel through which infrared remote control command signals are received.

Status/Exit • Allows the user to quickly confirm what channel number is currently being viewed. Status can also be used to clear the Television of on screen displays or information (rather than waiting for the displays to "time out" or automatically disappear from the screen).

Surf • The action of scanning specific channel in a limited channel list.

Twin Lead Wire • The more commonly used name for the two strand 300 Ohm antenna wire used with many indoor and outdoor antenna systems. In many cases this type of antenna wire requires an additional adapter (or balun) in order to connect to the 75 Ohm Input terminals designed into the more recent Televisions and VCRs.

Tuner Mode • Feature control settings made by the TV. Designed for first time set up and use. Settings for signal connections (antenna or cable TV), plus channel program memory are held in the TV's memory (even if the set is unplugged and moved to a new location.)

INDEX



Alternate Channel	33	Remote Control Buttons	6
Antenna TV Connection	7	Remote Control Operation (Basic)	5
Audio/Video Inputs	9	S-Video Inputs	10
Audio/Video Outputs	12	Safety Instructions	3
AutoLock (SmartLock)	21-28	Sharpness Control	18
Auto Program Control	16	Side A/V Inputs	13
AVL Control	19	Sleeptimer Control	29
Balance Control	19	SmartLock	
Bass Boost Control	19	Access Code	22
Brightness Control	18	Block All Control	25
Cable Box Connection	8	Block Channels Control	23
Cable TV Connection (Basic Connection)	7	Blocking Options	28
Care and Cleaning	35	Clear All Control	24
Channel Edit Control	17	Explanation of SmartLock	21
Closed Caption Control	30	Movie Rating Control	26
Color Control	18	TV Rating Control	27
Color Temperature Control	18	SmartPicture Control	31
Component Video Inputs	11	SmartSound Control	32
Contrast + Control	18	Table of Contents	4
Dynamic Noise Reduction (DNR) Control	18	Tint Control	18
Factory Service Information	38-39	Troubleshooting Tips	34
Format (Expand 4:3) Control	20	Treble Boost Control	19
Glossary of Terms	36	Tuner Mode Control	15
Index	37	TV Operation (Basic)	5
Language Control	14	Limited Warranty	40
Picture Control	18	Welcome/Registration Information	2



FACTORY SERVICE LOCATIONS

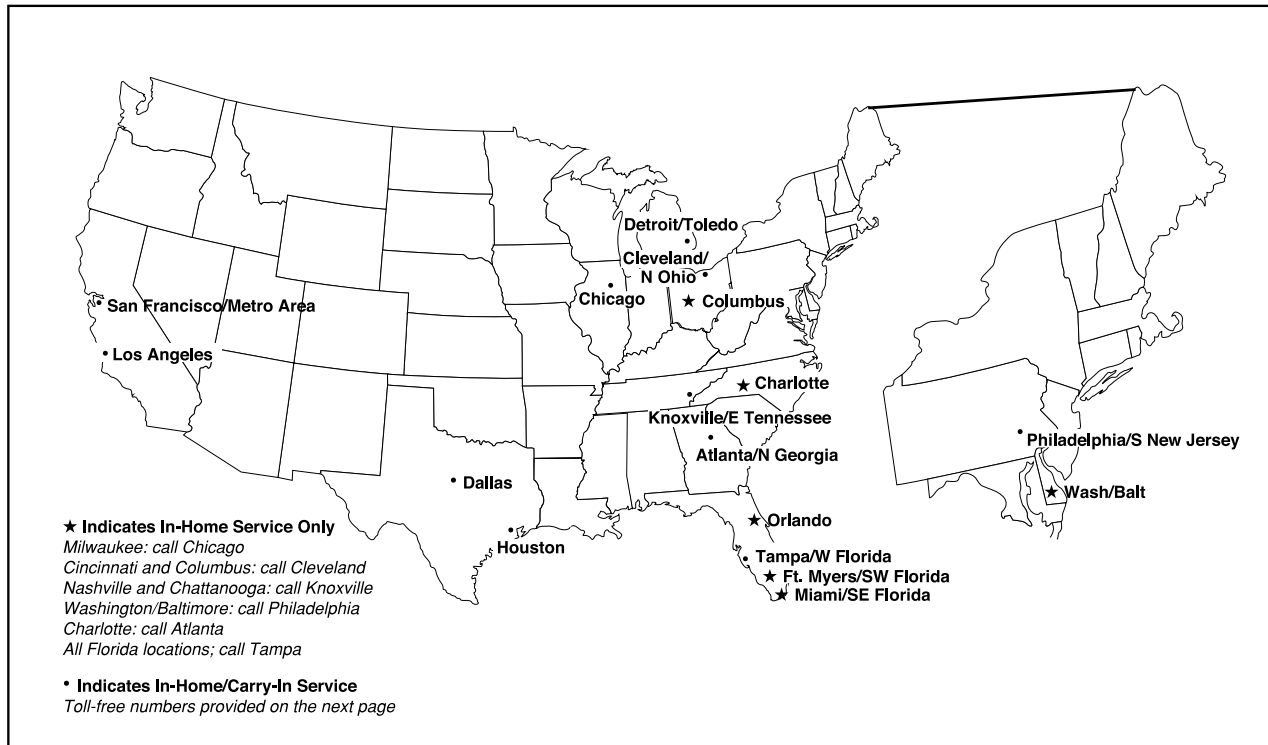

NOTE: If you reside in one of our Philips Factory Service Branch areas (see directory on back), you can contact the nearest Service Branch to obtain efficient and expedient repair for your product. If your product is In-Warranty, you should have proof-of-purchase to ensure No Charge Service. For Out-of-Warranty service, call the location nearest you.

NOTA: Si vous résidez dans une des régions desservies par une succursale de service après vente du fabricant Philips (voir liste ci-dessous), vous pourrez contacter la branche de service après vente la plus près de chez vous pour obtenir un service après vente rapide et efficace. Si le produit est sous garantie, il suffira de présenter une preuve d'achat pour bénéficier d'un service sans frais. Pour les produits non couverts par la garantie, contactez le centre le plus près de chez vous.

NOTA: Si Ud. reside en una de nuestras zonas para sucursales Philips de servicio al de fábrica (ver directorio más abajo), Ud. puede comunicarse con la sucursal de servicio más cercana para obtener una reparación oportuna y eficaz de su producto. Si su producto está todavía bajo garantía, Ud. debe presentar comprobante de compra para no ocasionar ningunos cargos por servicio. Para servicio después del vencimiento de la garantía, llame al lugar más cercano de los abajo indicados.

In Canada

How you can obtain efficient and expedient carry-in, mail-in, or in-home service for your product

Please contact Philips at

1-800-661-6162 (French speaking)

1-800-531-0039 (English or Spanish speaking)

Au Canada

Comment obtenir le service après-vente pour les produits apportés ou envoyés par la poste à notre centre de service ou le service à domicile

Veuillez contacter philips à:

1-800-661-6162 (Francophone)

1-800-531-0039 (Anglais ou Espagnol)

En el Canadá

Cómo recibir servicio eficiente para su producto, en persona, por correo o a domicilio

Favor de comunicarse con Philips al:

1-800-661-6162 (francófono)

1-800-531-0039 (Inglés o Español)

FACTORY SERVICE LOCATIONS



QUALITY SERVICE IS AS CLOSE AS YOUR TELEPHONE! SIMPLY LOOK OVER THE LIST BELOW FOR THE NUMBER OF A FACTORY SERVICE CENTER NEAR YOU. YOUR PRODUCT WILL RECEIVE EFFICIENT AND EXPEDIENT CARRY-IN, MAIL-IN, OR IN-HOME SERVICE, AND YOU WILL RECEIVE PEACE OF MIND, KNOWING YOUR PRODUCT IS BEING GIVEN THE EXPERT ATTENTION OF PHILIPS' FACTORY SERVICE.

COMMENT OBTENIR NOTRE SERVICE APRÈS VENTE RAPIDE ET EFFICACE SOIT PAR COURRIER, À DOMICILE, OU EN SE PRÉSENTANT À UN CENTRE DE SERVICE PHILIPS. PLUS DE 600 CENTRES DE RÉCEPTION DE PRODUITS À RÉPARER À TRAVERS LE PAYS: CONTACTER LE CENTRE DE SERVICE AUX CONSOMMATEURS LE PLUS PROCHE POUR SAVOIR L'EMPLACEMENT DE CES DÉPÔTS DANS UN RAYON DE 50 À 75 MILES (80 KM À 120 KM) DU CENTRE DE SERVICE LOCAL.

CÓMO OBTENER UN SERVICIO OPORTUNO Y EFICIENTE POR CORREO, EN CASA O EN PERSONA PARA SU PRODUCTO A TRAVÉS DE UN CENTRO PHILIPS DE SERVICIO. MAS DE 600 SITIOS POR TODO EL PAIS PARA LA RECEPCION DE PRODUCTOS NECESITADOS DE REPARACIONES: COMUNICARSE CON EL CENTRO DE SERVICIO DE FABRICA MAS CERCAÑO PARA ESTOS LUGARES DENTRO DE UN RADIO DE 80 A 120 KM (50 A 75 MILLAS) DEL CENTRO DE SERVICIO LOCAL.

ATLANTA

Philips Factory Service
550 Franklin Road., Suite F
Marietta, GA 30067
800-273-1501

TAMPA

Philips Factory Service
1911 US Highway 301 North, Suite 100
Tampa, FL 33619
800-442-2027

SAN FRANCISCO

Philips Factory Service
681 East Brokaw Rd.
San Jose, CA 95112
800-300-9013

HOUSTON

Philips Factory Service
1110 N. Post Oak Rd., Suite 100
Houston, TX 77055
800-952-3254

CLEVELAND

Philips Factory Service
950 Keynote Circle
Brooklyn Heights, OH 44131
800-331-7037

DETROIT

Philips Factory Service
25173 Dequindre
Madison Heights, MI 48071
800-438-1398

DALLAS

Philips Factory Service
415 N. Main Street, #107
Euless, TX 76040
800-952-3254

LOS ANGELES

Philips Factory Service
20930 Bonita, Ste. V
Carson, CA 90746
800-300-9013

CHICAGO

Philips Factory Service
1279 W. Hamilton Pkwy.
Itasca, IL 60143
800-531-2922

KNOXVILLE

Philips Factory Service
One Philips Drive
Knoxville, TN 37914
800-821-1767

PHILADELPHIA

Philips Factory Service
352 Dunks Ferry Rd.
Bensalem, PA 19020
800-847-9320



LIMITED WARRANTY

COLOR TELEVISION

90 Days Free Labor

One Year Parts Exchange

This product can be repaired in-home.

WHO IS COVERED?

You must have proof of purchase to receive warranty service. A sales receipt or other document showing that you purchased the product is considered proof of purchase.

WHAT IS COVERED?

Warranty coverage begins the day you buy your product. For 90 days thereafter, all parts will be repaired or replaced free, and labor is free. From 90 days to one year from the day of purchase, all parts will be repaired or replaced free, but you pay for all labor charges. After one year from the day of purchase, you pay for the replacement or repair of all parts, and for all labor charges.

All parts, including repaired and replaced parts, are covered only for the original warranty period. When the warranty on the product expires, the warranty on all replaced and repaired parts also expires.

WHAT IS EXCLUDED?

Your warranty does not cover:

- labor charges for installation or setup of the product, adjustment of customer controls on the product, and installation or repair of antenna systems outside of the product.
- product repair and/or part replacement because of misuse, accident, unauthorized repair or other cause not within the control of Magnavox.
- reception problems caused by signal conditions or cable or antenna systems outside the unit.
- a product that requires modification or adaptation to enable it to operate in any country other than the country for which it was designed, manufactured, approved and/or authorized, or repair of products damaged by these modifications.
- incidental or consequential damages resulting from the product. (Some states do not allow the exclusion of incidental or consequential damages, so the above exclusion may not apply to you. This includes, but is not limited to, prerecorded material, whether copyrighted or not copyrighted.)
- a product used for commercial or institutional purposes.

WHERE IS SERVICE AVAILABLE?

Warranty service is available in all countries where the product is officially distributed by Magnavox. In countries where Magnavox does not distribute the product, the local Magnavox service organization will attempt to provide service (although there may be a delay if the appropriate spare parts and technical manual(s) are not readily available).

MAKE SURE YOU KEEP...

Please keep your sales receipt or other document showing proof of purchase. Attach it to this owner's manual and keep both nearby. Also keep the original box and packing material in case you need to return your product.

BEFORE REQUESTING SERVICE...

Please check your owner's manual before requesting service. Adjustments of the controls discussed there may save you a service call.

TO GET WARRANTY SERVICE IN U.S.A., PUERTO RICO, OR U.S. VIRGIN ISLANDS...

Contact a Magnavox factory service center (see enclosed list) or authorized service center to arrange repair.

(In U.S.A., Puerto Rico, and U.S. Virgin Islands, all implied warranties, including implied warranties of merchantability and fitness for a particular purpose, are limited in duration to the duration of this express warranty. But, because some states do not allow limitations on how long an implied warranty may last, this limitation may not apply to you.)

TO GET WARRANTY SERVICE IN CANADA...

Please contact Magnavox at:

1-800-705-2000

(In Canada, this warranty is given in lieu of all other warranties. No other warranties are expressed or implied, including any implied warranties of merchantability or fitness for a particular purpose. Magnavox is not liable under any circumstances for any direct, indirect, special, incidental or consequential damages, howsoever incurred, even if notified of the possibility of such damages.)

REMEMBER...

Please record below the model and serial numbers found on the product. Also, please fill out and mail your warranty registration card promptly. It will be easier for us to notify you if necessary.

MODEL # _____

SERIAL # _____

This warranty gives you specific legal rights. You may have other rights which vary from state/province to state/province.

Magnavox, P.O. Box 520890, Miami, FL 33152 (402) 536-4171

EL6570E001 / 10-03

Free Manuals Download Website

<http://myh66.com>

<http://usermanuals.us>

<http://www.somanuals.com>

<http://www.4manuals.cc>

<http://www.manual-lib.com>

<http://www.404manual.com>

<http://www.luxmanual.com>

<http://aubethermostatmanual.com>

Golf course search by state

<http://golfingnear.com>

Email search by domain

<http://emailbydomain.com>

Auto manuals search

<http://auto.somanuals.com>

TV manuals search

<http://tv.somanuals.com>