

OWNER'S MANUAL

MAGNAVOX
SMART. VERY SMART.

MVR440MG/17
MVR450MG/17
MVR650MG/17

Video Cassette Recorder



THANK YOU FOR CHOOSING MAGNAVOX.

NEED HELP FAST?

READ YOUR QUICK-USE GUIDE AND/OR OWNER'S MANUAL FIRST FOR QUICK TIPS THAT MAKE USING YOUR MAGNAVOX PRODUCT MORE ENJOYABLE. IF YOU HAVE READ YOUR INSTRUCTIONS AND STILL NEED ASSISTANCE, YOU MAY ACCESS OUR ONLINE HELP AT WWW.MAGNAVOX.COM OR CALL 1-800-705-2000 WHILE WITH YOUR PRODUCT.



IMPORTANT!
*RETURN YOUR WARRANTY REGISTRATION CARD WITHIN 10 DAYS.
SEE WHY INSIDE.*

Return your Warranty Registration card today to ensure you receive all the benefits you're entitled to.

Once your MAGNAVOX purchase is registered, you're eligible to receive all the privileges of owning a MAGNAVOX product. So complete and return the Warranty Registration Card enclosed with your purchase at once. And take advantage of these important benefits.

Warranty Verification	Owner Confirmation	Model Registration
Registering your product within 10 days confirms your right to maximum protection under the terms and conditions of your MAGNAVOX warranty.	Your completed Warranty Registration Card serves as verification of ownership in the event of product theft or loss.	Returning your Warranty Registration Card right away guarantees you'll receive all the information and special offers which you qualify for as the owner of your model.

Congratulations on your purchase, and welcome to the "family!"



Dear MAGNAVOX product owner:

Thank you for your confidence in MAGNAVOX. You've selected one of the best-built, best-backed products available today. And we'll do everything in our power to keep you happy with your purchase for many years to come.

As a member of the MAGNAVOX "family," you're entitled to protection by one of the most comprehensive warranties and outstanding service networks in the industry.

What's more, your purchase guarantees you'll receive all the information and special offers for which you qualify, plus easy access to accessories from our convenient home shopping network.

And most importantly you can count on our uncompromising commitment to your total satisfaction.

All of this is our way of saying welcome-and thanks for investing in a MAGNAVOX product.

P.S. Remember, to get the most from your MAGNAVOX product, you must return your Warranty Registration Card within 10 days. So please mail it to us right now!

Know these **safety** symbols



⚡ This "bolt of lightning" indicates uninsulated material within your unit may cause an electrical shock. For the safety of everyone in your household, please do not remove product covering.

⚠ The "exclamation point" calls attention to features for which you should read the enclosed literature closely to prevent operating and maintenance problems.

WARNING: TO PREVENT FIRE OR SHOCK HAZARD, DO NOT EXPOSE THIS EQUIPMENT TO RAIN OR MOISTURE.

CAUTION: To prevent electric shock, match wide blade of plug to wide slot, fully insert.

ATTENTION: Pour éviter les choc électriques, introduire la lame la plus large de la fiche dans la borne correspondante de la prise et pousser jusqu'au fond.

For Customer Use

Enter below the Serial No. which is located on the rear of the cabinet. Retain this information for future reference.

Model No. _____
Serial No. _____

Visit our World Wide Web Site at <http://www.magnavox.com>

Introduction 3

This manual describes the MVR440MG/17, MVR450MG/17, and MVR650MG/17. The MVR440MG/17 and MVR450MG/17 have a single sound channel, but the MVR650MG/17 has stereo sound (right and left sound channels). Otherwise, these models look and operate the same. This manual illustrates the MVR650MG/17.

Features

- Automatic Channel Setup
- Automatic Head Cleaner
- Automatic Tracking Adjustment
- Hi-Fi Stereo Sound (MVR650MG/17 only)
- MTS (Multi-Channel Television Sound) (MVR650MG/17 only)
- 19 micron head - Improves the picture quality
- On-Screen Displays in English, French and Spanish
- One-Touch Recording
- Real-Time Counter
- Repeat Play
- Search Functions: Index, Time
- Timer Recording

Package contents

The following items are provided with your new VCR.

- Remote Control and two AA batteries
- One RF coaxial cable, 75 ohm
- This Owner's manual and Quick-Use Guide

Safety Precautions

Warning: To prevent fire or shock hazard, do not expose this equipment to rain or moisture.

Federal Communications Commission Warning: Any unauthorized changes or modifications to this equipment void the user's authority to operate it.

This VCR has a High Quality (HQ) system and is compatible with existing Video Home System (VHS) equipment. Magnavox recommends you use only video cassettes that have the **VHS** mark. Using other tapes may result in poor picture quality and excessive deposits on the video heads, which may not be covered by the warranty if damage occurs.

Note to the Cable TV System Installer: This reminder is provided to call the Cable TV system installer's attention to Article 820-40 of the National Electrical Code, which provides guidelines for proper grounding – in particular, specifying that the cable ground shall be connected to the grounding system of the building, as close to the point of cable entry as possible.

Declaration of Conformity

Model Numbers: MVR440MG/17, MVR450MG/17,
MVR650MG/17

Trade Name: Magnavox

Responsible Party: Philips Consumer Electronics
P.O. Box 14810
Knoxville, TN 37914-1810
(865) 521-4316

Copyright 2004 Magnavox. All rights reserved.

Helpful Hints

- *Before doing anything else, record the VCR's model and serial numbers in the spaces provided on page two. These numbers will help us assist you if you ever call for help.*
- *Your new product and its packaging contain materials that can be recycled and reused. Specialized companies can recycle your product to increase the amount of reusable materials and to minimize the amount that needs to be properly disposed.*
Your product uses batteries that should not be thrown away when depleted but should be disposed of as small chemical waste.
Please find out about the local regulations on disposal of your old product, batteries, and packaging whenever you replace existing equipment.

4 Table of Contents

Setting Up Your VCR

Introduction	3
Table of Contents	4
Before Using Your VCR	5
Hookups: No Cable Box/Satellite	6-7
Hookups with Cable Box/Satellite	8-9
Hookups with a Stereo TV	10
Turning on Your VCR	11
Automatic Channel Setup	12-13
Setting the Clock	14-15
Language Selection	16

Description of Controls

On-Screen Status Displays	17
Remote Control	18-19
Display Panel	20
Front Panel	21
Rear Panel	22

Basic Operations

Playing	23
Recording	24

Recording

One-Touch Recording	25
Timer Recording	26-30
Recording One Channel/Watching Another	31
Rerecording (Tape Duplication)	32

Playing

Repeat Play	33
Special Effects Playback	34
Real-Time Counter Memory	35
Time Search	36
Index Search	37
Automatic Playback Features	38

Additional Features

MTS Broadcast Stereo (MVR650MG/17)	39-40
Hi-Fi Stereo (MVR650MG/17)	41

Information You May Need

Helpful Hints	42-43
Glossary	44
Specifications	45
Limited Warranty	46
Index	47

Before Using Your VCR 5

Putting Batteries in the Remote Control

- 1** Remove the **battery compartment lid** on the bottom of the remote by sliding the lid in the direction of the arrow.
- 2** Insert **two AA batteries** inside the battery compartment with their + and – ends aligned as indicated.
- 3** Replace the **battery compartment lid**.

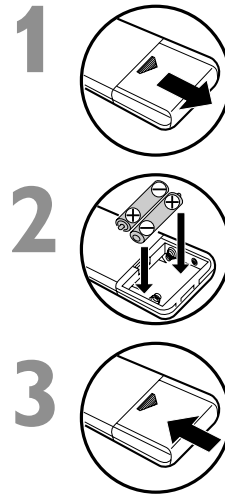

Using the Remote Control

- Point the remote at the VCR's remote sensor (see page 21) when using the remote to operate the VCR.
- Do not put objects between the remote and the VCR.

Recording Prevention

Videotapes have record tabs to ensure that recordings are not erased accidentally.

- 1** To prevent recording, break off the tab with a screwdriver.
- 2** To allow recording, cover the hole with cellophane tape.

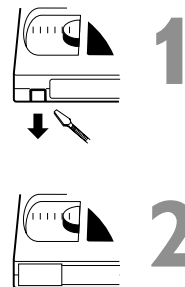

VCR maintenance

- In this VCR, use only tapes with the **VHS** mark.
- Make sure any light adhesive stick-on notes are removed from the videotape before putting the tape in the VCR. Removable labels can jam the VCR.
- Periodic maintenance is required to maintain your VCR's excellent performance. This VCR has a built-in Automatic Head Cleaner. However, the video heads will require replacement eventually. Only an authorized service center should perform this service.

Helpful Hints

- Do not mix alkaline and manganese batteries.
- Do not mix old and new batteries.

6 Hookups: No Cable Box/Satellite

The basic VCR/TV connection – antenna/Cable TV signal to VCR to TV – is shown below. If you have a Cable Box or Satellite Receiver, see pages eight-nine. If you have a Stereo TV, see page 10. After you hook up the VCR, go to page 11 to turn on the VCR.

(The MVR650MG/17 is illustrated here. The MVR440MG/17 and MVR450MG/17 have single AUDIO IN/OUT jacks.)

1 Disconnect the antenna or Cable TV signal from your TV.

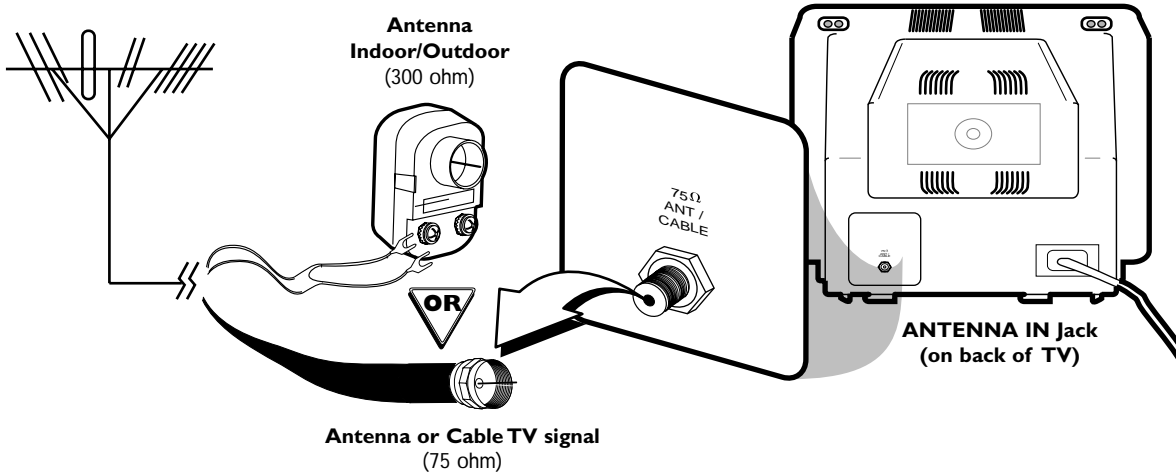

2 Connect the antenna or Cable TV signal to the ANT(enna) IN Jack of your VCR.

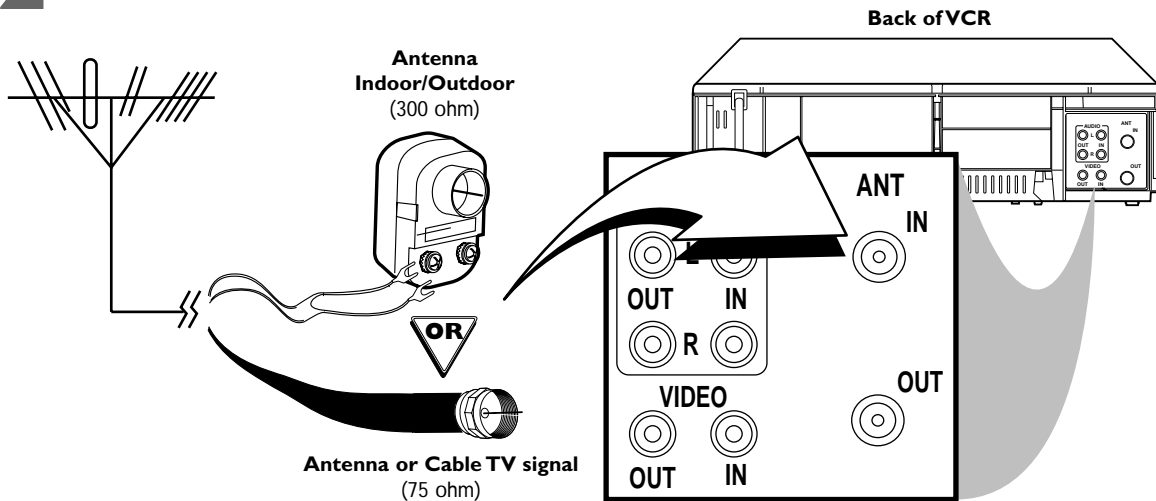

Hookups: No Cable Box/Satellite (cont'd) 7

- 3** Connect the RF coaxial cable (supplied) to the **OUT** Jack on the back of the VCR and to the **Antenna In** jack on the TV. (You may use either a snap-on type (supplied) or screw-on type, whichever you prefer.)

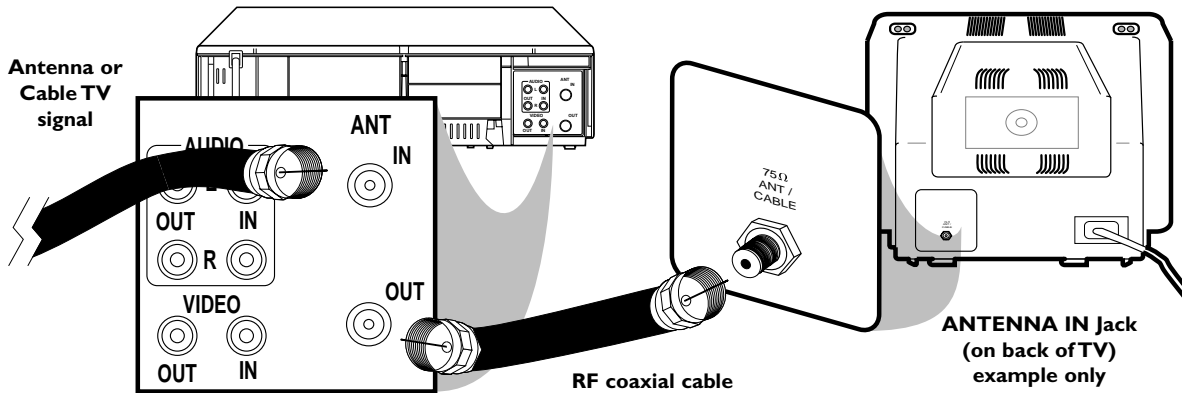

- 4** Plug in the AC power cords of the TV and the VCR.

- 5** Set the TV to channel 3. This is the VCR's preset RF output channel. If you cannot use channel 3 at your TV, use channel 4 instead. To change the VCR's output channel to 4, press and hold PLAY on the VCR for three seconds during tape play. The VCR's RF output channel will alternate between 3 and 4 each time you do this. There is not a channel 3/4 switch on the VCR. You must change the RF output channel as described.

- If the RF output channel does not change, stop tape play, then start play again. Try again to press and hold PLAY on the front of the VCR for three seconds during tape play.
- If the power fails or if you unplug the VCR's power cord for more than 30 seconds, the RF output channel will return to channel 3.

- 6** You are ready to turn on the VCR. Please go to page 11 for directions before turning on the VCR.

8 Hookups with Cable Box/Satellite

There are two ways to connect your Cable Box/Satellite to the VCR. With this connection:

- You may view any channel. Select channels at the Cable Box/Satellite, not at the VCR.
- You may not view a channel other than the one you are recording.
- Do not set up channels at the VCR.
- Program a timer recording for one channel at a time. Set the TV and the VCR to the Cable Box/Satellite output channel (03 or 04); set the RF output channel of the VCR to the same channel (see page seven). Set your Cable Box/Satellite to the channel you want to record. When you enter the channel you want to record in a timer recording, enter 03 or 04 (the Cable Box/Satellite output channel). (This is step 7 on page 28.) Leave the Cable Box/Satellite on for a timer recording.

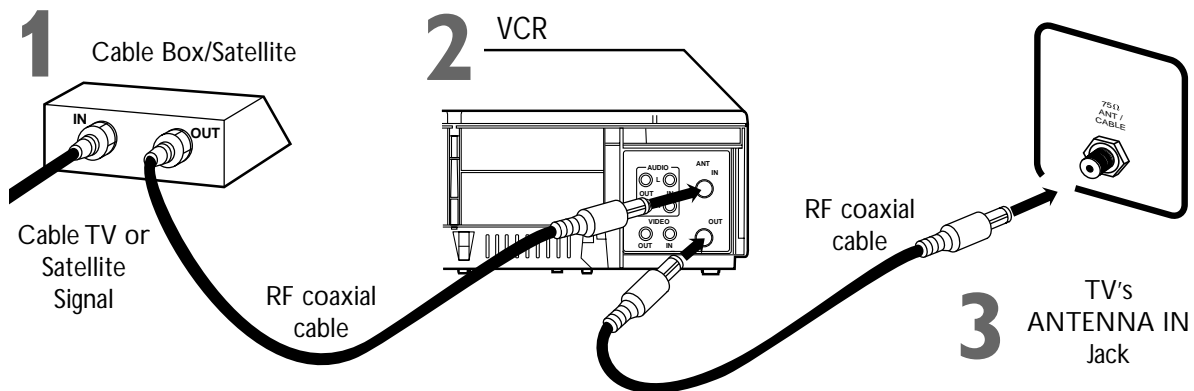

Connections

- 1** Connect a Cable TV or Satellite signal to the IN Jack on the Cable Box/Satellite.
- 2** Use an RF coaxial cable (supplied) to connect the OUT Jack on the Cable Box/Satellite to the ANT(enna) IN Jack on the VCR.
- 3** Use a second RF coaxial cable to connect the OUT Jack on the VCR to the TV's ANTENNA IN jack.

Recording/Viewing Any Channel

- 1** With the VCR on and in VCR position (the green VCR/TV light will appear on the display panel), use **CH \wedge/\vee** to set the VCR to the Cable Box/Satellite output channel (03 or 04).
- 2** Set the VCR's RF output channel to 3 or 4. The default setting is channel 3. See page seven. Set the TV to the same channel.
- 3** Select the channel you want to view/record at the Cable Box/Satellite.

Hookups with Cable Box/Satellite (cont'd) 9

With this connection:

- You may watch one channel while recording another.
- You may not record scrambled channels.

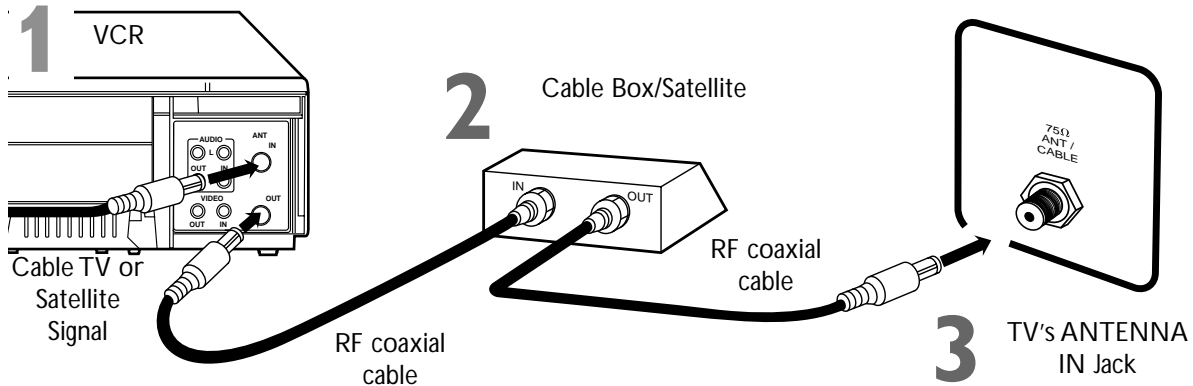

Connections

- 1 Connect a Cable TV or Satellite signal to the VCR's ANT(enna) IN Jack.
- 2 Use an RF coaxial cable (supplied) to connect the OUT Jack on the VCR to the IN Jack on the Cable Box/Satellite.
- 3 Use a second RF coaxial cable to connect the OUT Jack on the Cable Box/Satellite to the ANTENNA IN Jack on the TV.

Recording One Channel/Watching Another

- 1 **Put the Cable Box/Satellite on the same channel as the VCR's RF output channel.** The default is channel 3. See page seven. Set the TV to the Cable Box/Satellite output channel (03 or 04). **Then, with the VCR in VCR position (the green VCR/TV light will appear on the display panel), use CH \wedge/\vee to select the channel you want to record at the VCR. Start the recording.**
- 2 **Press VCR/TV once to put the VCR in TV position.** (The VCR/TV light will disappear.)
- 3 **Select the channel you want to watch at the Cable Box/Satellite.**

Helpful Hint

- When you play a tape, set the Cable Box/Satellite to the same channel as the RF output channel of the VCR. (See page seven.) Set the TV to the Cable Box/Satellite output channel (03 or 04).

10 Hookups with a Stereo TV

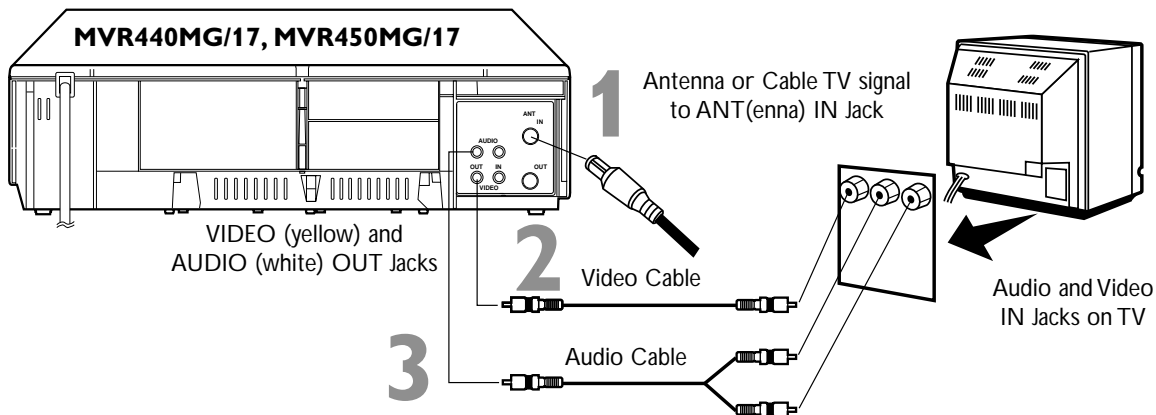
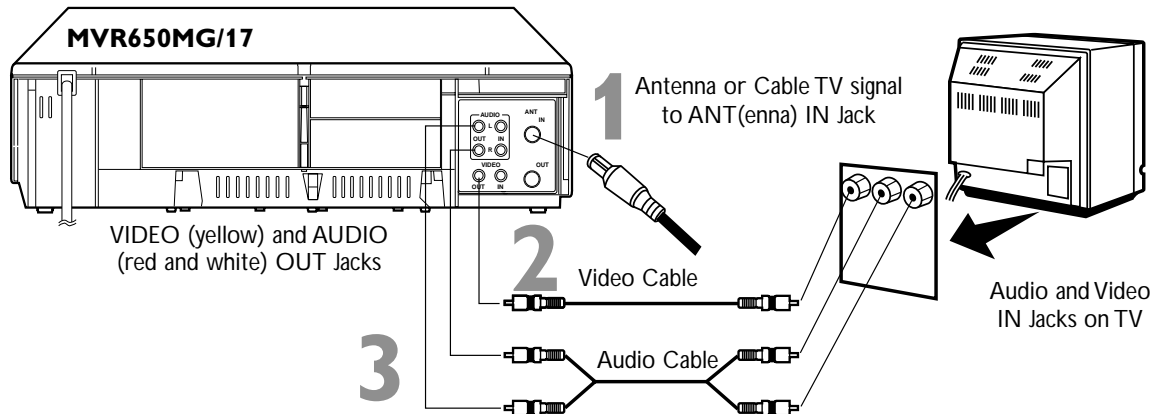

- Audio and Video cables are not supplied.

- 1** Connect the antenna or Cable TV signal to the ANT(enna) IN Jack on the back of the VCR.
- 2** Connect a video cable to the VCR's yellow VIDEO OUT Jack and to the TV's VIDEO IN Jack.
- 3** **MVR650MG/17**
Connect a stereo audio cable to the VCR's red and white AUDIO OUT Jacks and to the TV's AUDIO IN Jacks. Match cable colors to jack colors.

MVR440MG/17, MVR450MG/17

Connect a "Y" splitter audio cable to the VCR's white AUDIO OUT Jack and to the TV's AUDIO IN Jacks.

- 4** Turn on your TV, making sure it is in Line Input or Auxiliary mode. Your TV may refer to this as an Audio/Video In channel, or A/V In, External In, Auxiliary In, etc. Such channels are usually located near channel zero (0). Or, your TV remote may have a button or switch that selects different Video or Auxiliary channels. See your TV manual for details.

Helpful Hint

- If your TV has only one AUDIO IN jack, connect a single audio cable to the white AUDIO OUT jack on the VCR and to the white AUDIO IN jack on the TV. See your TV manual for details of connecting a VCR to the TV.

Turning on Your VCR 11

- Before turning on your VCR, make sure batteries are in the remote and the VCR and TV are connected (see pages 5-10).
- You cannot set up channels if you are using a Cable Box/Satellite.
- The instructions on this page only work when you turn on the VCR for the first time. If there is a power failure or if the VCR is unplugged for more than 30 seconds, repeat this procedure.

1 Press POWER. The POWER light and the VCR/TV light will appear.

2 Turn on the TV. Set it to the same channel as the RF output channel of the VCR (see page seven). If you connected the VCR to a TV using Audio/Video cables, choose the A/V In or Auxiliary In or Line Input channel at the TV. The menu shown below will appear.

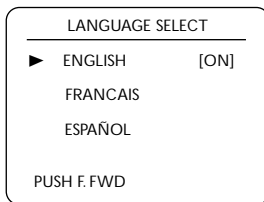

3 Press PLAY or STOP to select ENGLISH, FRANCAIS or ESPAÑOL. [ON] will appear beside your choice.

4 Press F.FWD. AUTO SET UP will appear on the screen.

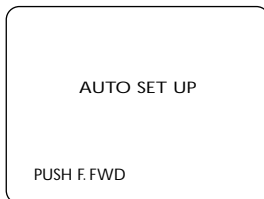

5 Press F.FWD to begin automatic channel setup. AUTO SET UP will flash on the screen and channels will count up on the screen as setup progresses. When channels are set up, the VCR will go to the lowest channel available. The VCR will memorize all available channels, so when you use CH ^/∨ to change TV channels at the VCR, you'll only scan through channels you receive.

2 Turn on the TV.

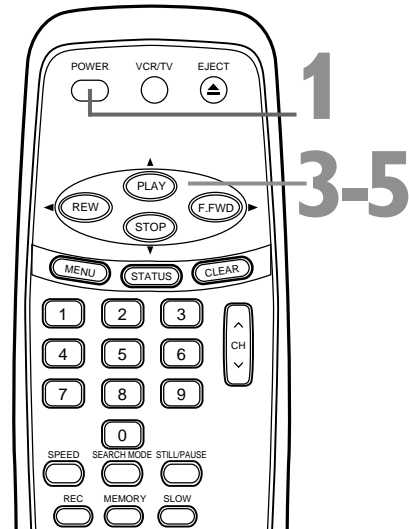

Helpful Hints

- If you do not see any displays when you turn on the VCR, check your hookups, then try again. If you still do not see any displays, follow the steps under "Automatic Channel Setup" on page 12 and "Language Selection" on page 16.
- If you try to set up channels when there is no antenna or cable connected to the VCR, programming will appear to take place. Eventually, AUTO SET UP will appear on the screen steadily, and channel programming will stop. Connect an antenna or cable to the ANT(enna) IN jack of the VCR, then press F.FWD again. Channel programming will begin again.
- To stop channel setup, press CLEAR.

12 Automatic Channel Setup

Although your VCR may set channels when you turn it on the first time, you may set up channels again. Make sure:

- The VCR is on and is in VCR position. (The VCR/TV light will appear on the display panel. If it does not, press VCR/TV once.)
- Your antenna or Cable TV signal is connected to the VCR. See pages six-10.

1 Press **MENU** until **MENU** appears.

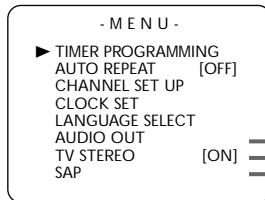

MVR650MG/17 only

2 Press **PLAY** or **STOP** repeatedly to select **CHANNEL SET UP**. Press **F.FWD**.

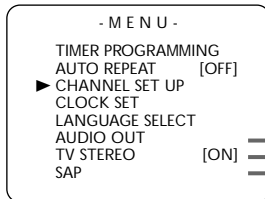

MVR650MG/17 only

3 Press **PLAY** or **STOP** repeatedly to select **AUTO SET UP**.

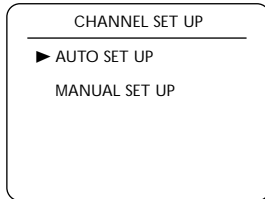

4 Press **F.FWD**. The VCR will memorize all available channels. **AUTO SET UP** will flash and channels will count up as setup progresses. When setup is complete, the lowest channel you receive will appear on the TV screen.

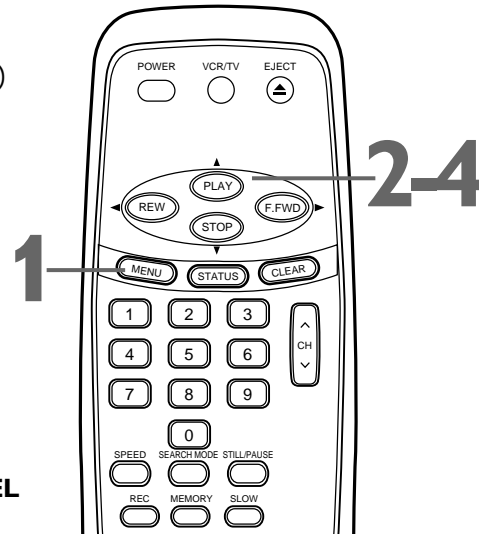

Helpful Hints

- Line Input mode is always channel 001 or 002. Select these channels with the Number buttons or CH \wedge/\vee . Choose L1 if you connected other equipment to the AUDIO and VIDEO IN jacks on the back of the VCR. Choose L2 if you connected other equipment to the AUDIO and VIDEO In jacks on front of the VCR.
- You cannot program channels if you are using a Cable Box/Satellite. See pages eight-nine.
- To stop channel setup, press CLEAR.

Automatic Channel Setup (cont'd) 13

Adding/Deleting Channels

Delete channels you no longer receive or seldom watch from the memory. Or, add new channels. Make sure:

- The VCR is on and in VCR position. (The VCR/TV light will appear. If it does not, press VCR/TV once.)

1 Press **MENU** until **MENU** appears.

2 Press **PLAY** or **STOP** repeatedly to select **CHANNEL SET UP**. Press **F.FWD**.

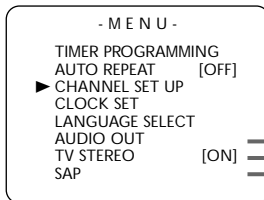

MVR650MG/17 only

3 Press **PLAY** or **STOP** repeatedly to select **MANUAL SET UP**. Press **F.FWD**.

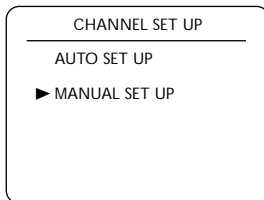

4 Press **PLAY** or **STOP** repeatedly until your desired channel number appears.

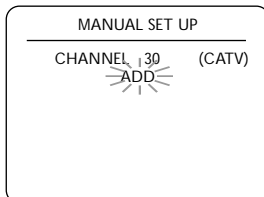

5 Press **F.FWD** or **REW** so **ADD** or **DELETE** flashes on the screen.

6 While your choice is flashing, press **CLEAR**. The channel you added or deleted will appear. The channel will be added or deleted, whichever was flashing on the screen when you exited the menu.

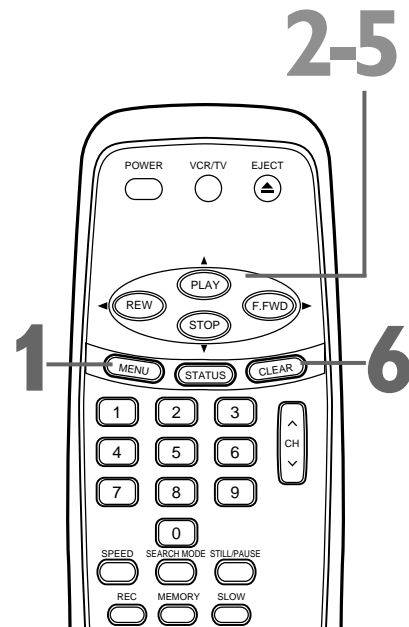

Helpful Hint

- To add or delete more than one channel, repeat steps 4-5 for all the channels. Then press **CLEAR** to save all the settings.

14 Setting the Clock

Follow the steps below to set your VCR's clock. Make sure:

- The VCR is on and in VCR position. (The VCR/TV light will appear. If it does not, press VCR/TV once.)

1 Press **MENU** until **MENU** appears.

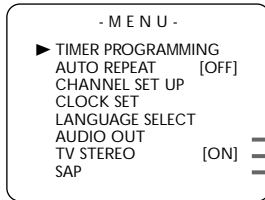

MVR650MG/17 only

2 Press **PLAY** or **STOP** repeatedly to select **CLOCK SET**. Press **F.FWD**.

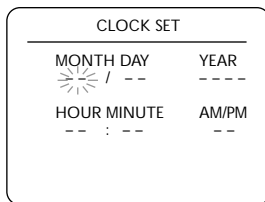

3 While **MONTH** is flashing, press **PLAY** or **STOP** repeatedly until the desired month appears. Press **F.FWD**.

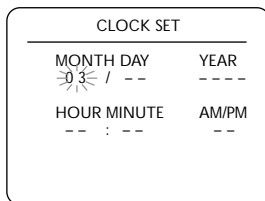

4 While **DAY** is flashing, press **PLAY** or **STOP** repeatedly until the desired day appears. Press **F.FWD**.

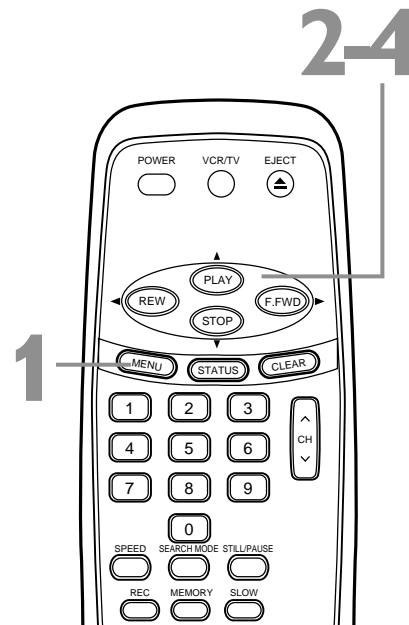
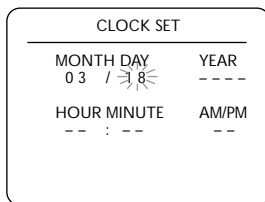

Helpful Hints

- If the clock has never been set, the **CLOCK SET** menu may appear immediately when you press **MENU**. If this happens, follow the instructions from step 3 above.
- To display the time on the TV, press **STATUS** repeatedly.
- Power failures exceeding 30 seconds can erase your clock setting.
- Press **REW** to go back one step.

Setting the Clock (cont'd) 15

- 5** While **YEAR** is flashing, press **PLAY** or **STOP** repeatedly until the desired year appears. Press **F.FWD**. The day of the week will appear automatically.

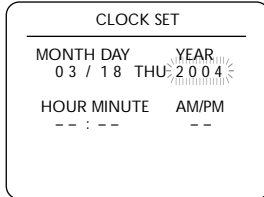

- 6** While **HOUR** is flashing, press **PLAY** or **STOP** repeatedly until the desired hour appears. Press **F.FWD**.

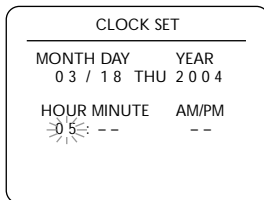

- 7** While **MINUTE** is flashing, press **PLAY** or **STOP** repeatedly until the desired minute appears. Press **F.FWD**.

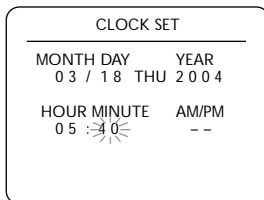

- 8** While **AM/PM** is flashing, press **PLAY** or **STOP** repeatedly to point to **AM** or **PM**. Your selection will flash on the screen in the AM/PM space.

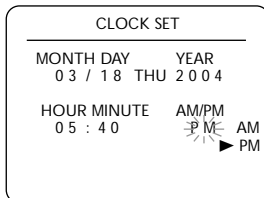

- 9** Press **CLEAR** or **F.FWD** to start the clock.

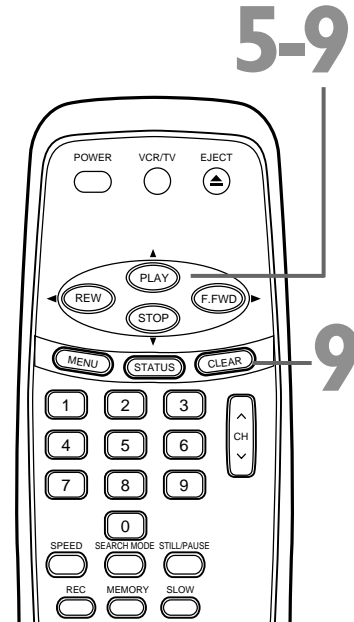

Helpful Hint

- To reset the clock, follow steps 1-2 on page 14. Select information to change using **F.FWD** or **REW**. When the desired information is flashing, use **PLAY** or **STOP** to enter the correct information. Press **CLEAR** to remove the menu.

16 Language Selection

Follow the steps below to change the language of the on-screen menus and displays. Make sure:

- The VCR is on and in VCR position. (The VCR/TV light will appear. If it does not, press VCR/TV once.)

1 Press MENU until MENU appears.

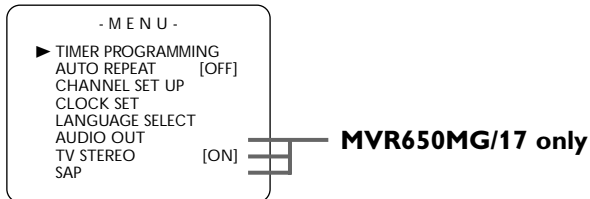

2 Press PLAY or STOP repeatedly to select LANGUAGE SELECT. Press F.FWD.

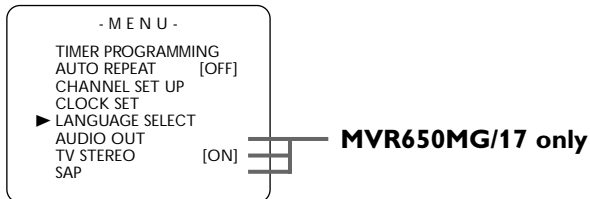

3 Press PLAY or STOP to select ENGLISH, FRANCAIS, or ESPAÑOL. [ON] will appear beside your choice.

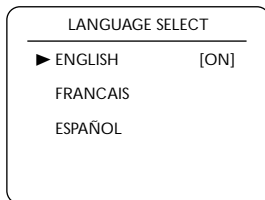

4 Press CLEAR to remove the menu.

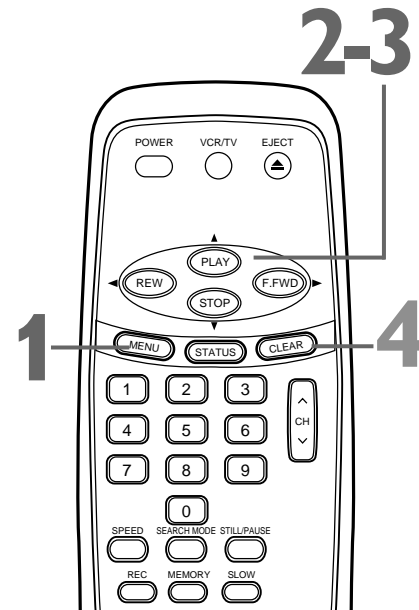

Helpful Hint

- If you accidentally select Spanish or French and need English:
1) Press MENU until MENU appears.
2) Press PLAY or STOP repeatedly to choose SELEC. IDIOMA or SELECTION LANGUE. Press F.FWD.
3) Press PLAY or STOP to select ENGLISH.
4) Press CLEAR to remove the menu.

On-Screen Status Displays 17

You may access on-screen status displays by pressing STATUS repeatedly. Displays may include the current time, channel, and other information.

- Press STATUS once. The COUNT on-screen status display will appear for five seconds. After five seconds, only the real-time counter will appear on the screen. This counter shows you the elapsed playing time of the tape (from the point at which the real-time counter was set to zero).
- Press STATUS once again. The CLOCK on-screen status display will appear for five seconds. After five seconds, only the current time will appear on the screen (the clock must be set). If you are watching TV, the current channel number and the availability of stereo or second audio (MVR650MG/17 only) will also appear on the screen.
- Press STATUS once again. The on-screen status display will disappear.

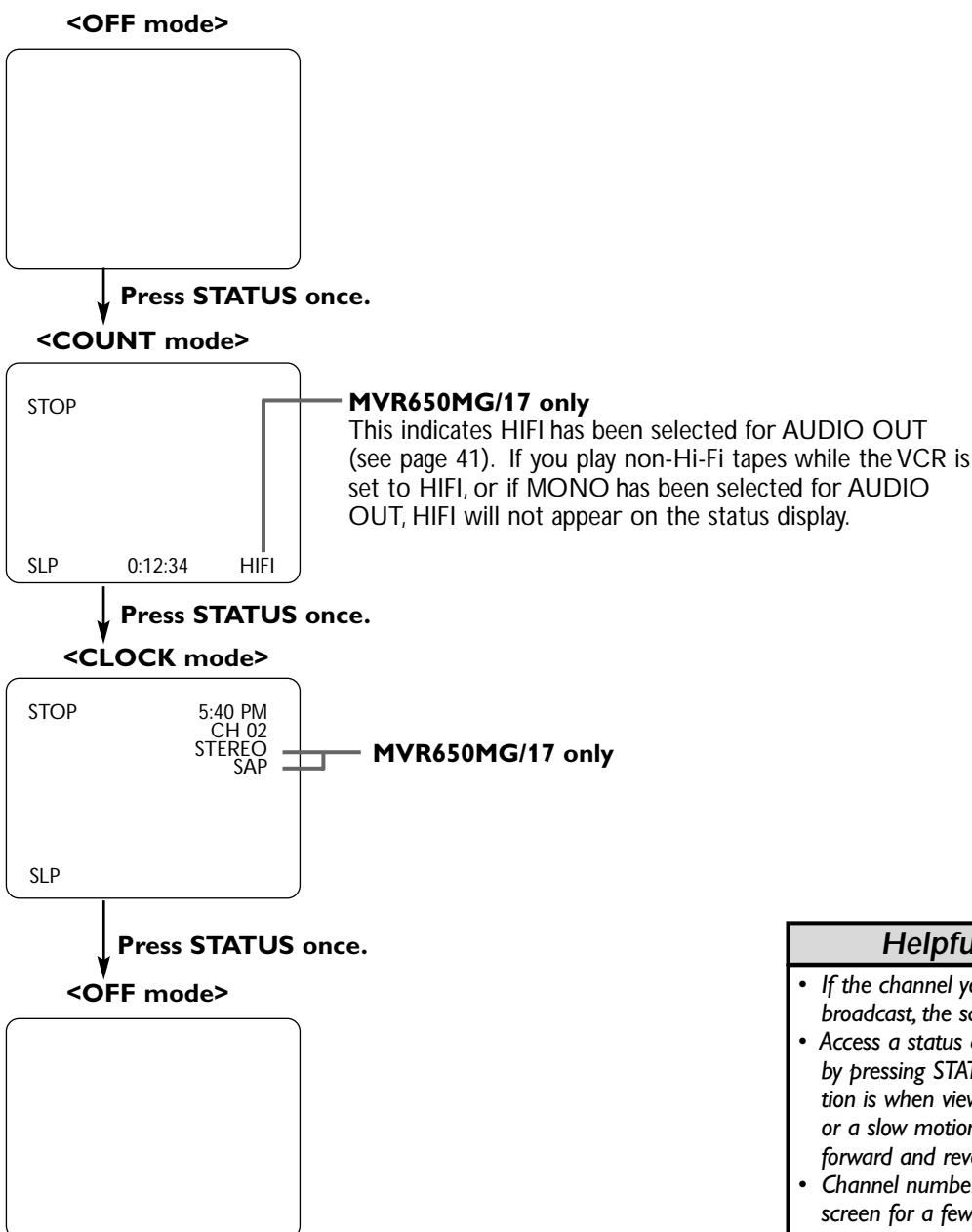

Helpful Hints

- If the channel you select has no broadcast, the screen will be blue.
- Access a status display any time by pressing STATUS. (The exception is when viewing a still picture or a slow motion picture, or during forward and reverse searching.)
- Channel numbers appear on the screen for a few seconds at each channel change.

18 Remote Control

EJECT Button
Press to eject the tape.

VCR/TV Button
Select the signal your TV receives from the VCR.

- **VCR Position**
Watch a tape, watch a program while recording it, or watch TV using CH \wedge/\vee or the Number buttons to change channels at the VCR. The VCR/TV light appears when in VCR position.
- **TV Position**
Watch TV (changing channels at the TV) or watch one program while recording another. See page 31.

POWER Button
Press to turn the VCR on or off.

PLAY Button
Press to play a tape. Also, press to release Slow, Search, or Still mode and return to normal play. See page 34. Use to select an item in the menu or enter information in the menu.

MENU Button
Press repeatedly to access menus or to remove menus.

Number Buttons
Press to select channels at the VCR.
Enter channel numbers as a two-digit number for the quickest results. For example, to select channel 6, press 0,6. If you only press the Number 6 button, channel 6 will appear after a brief delay. (There also may be a brief delay when you select channels 10, 11, and 12.) To select channels 100 and above, enter channel numbers as a three-digit number. For example, to select channel 117, press 1, 1, 7.

REC Button
Press to start a recording or a timed One-Touch Recording. See pages 24-25.

MEMORY Button
Press to memorize a tape position. See page 35.

SLOW Button
Press for slow motion play. See page 34.

CH \wedge/\vee Button
Press to scan through the VCR's available channels. See pages 12-13.
Press to adjust tracking. See page 38.

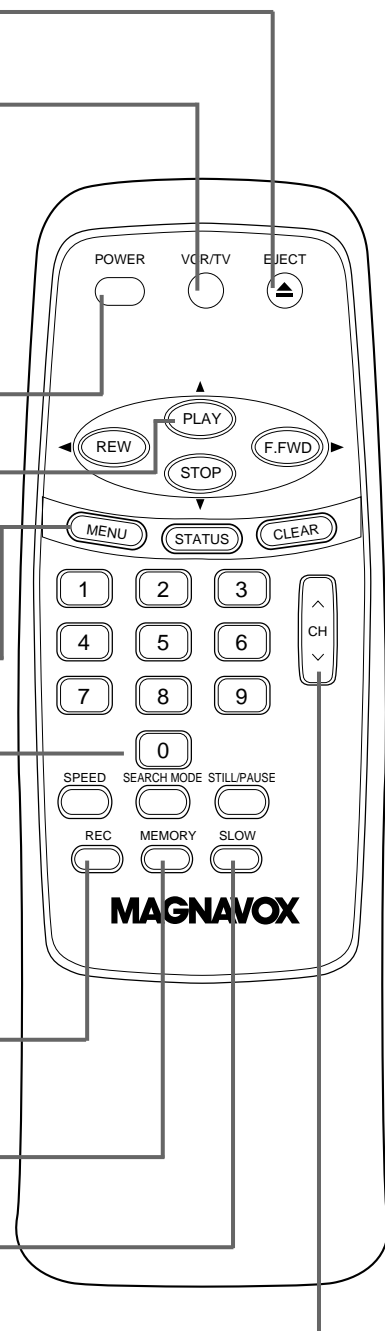

Remote Control (cont'd) 19

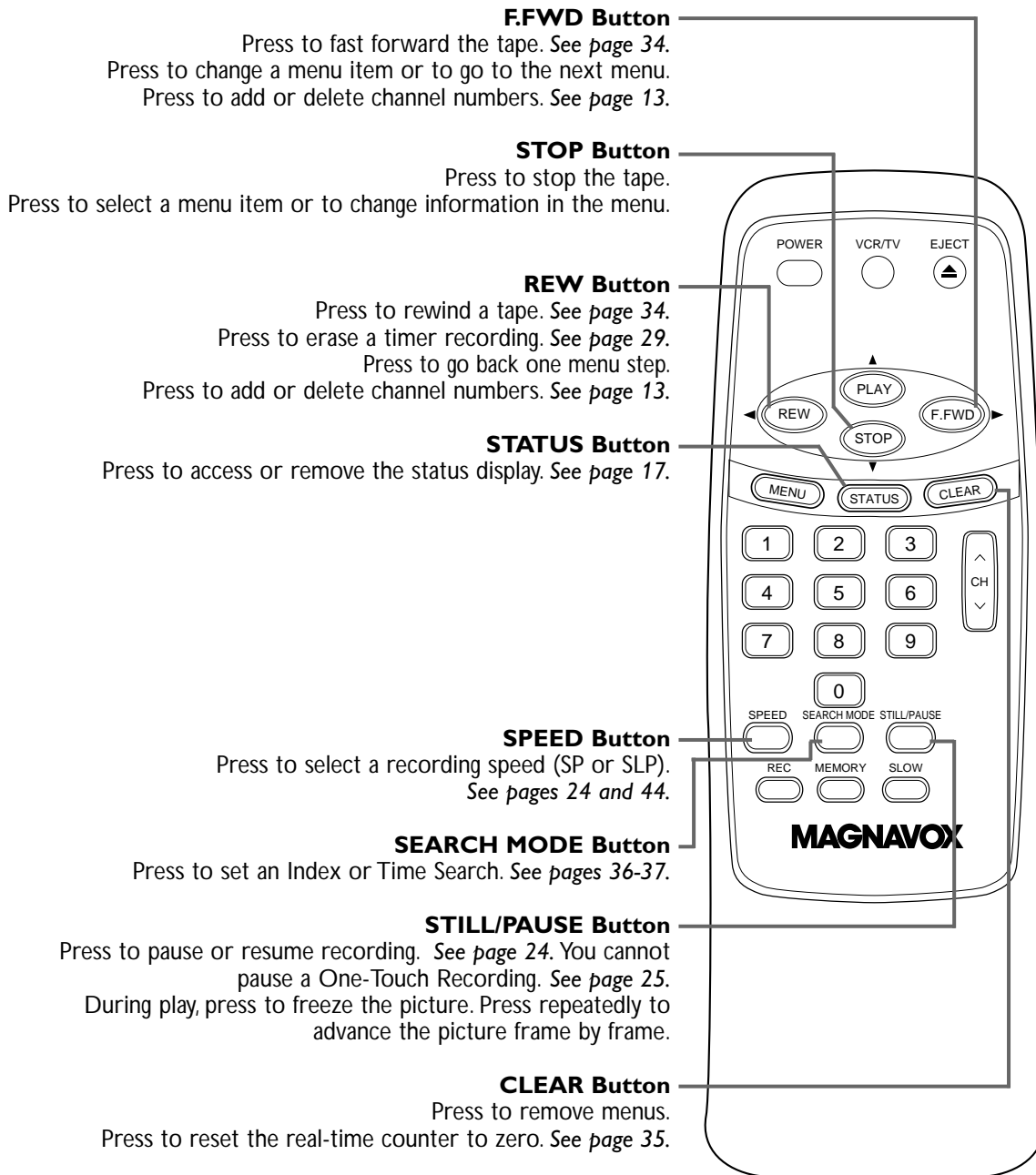

20 Display Panel

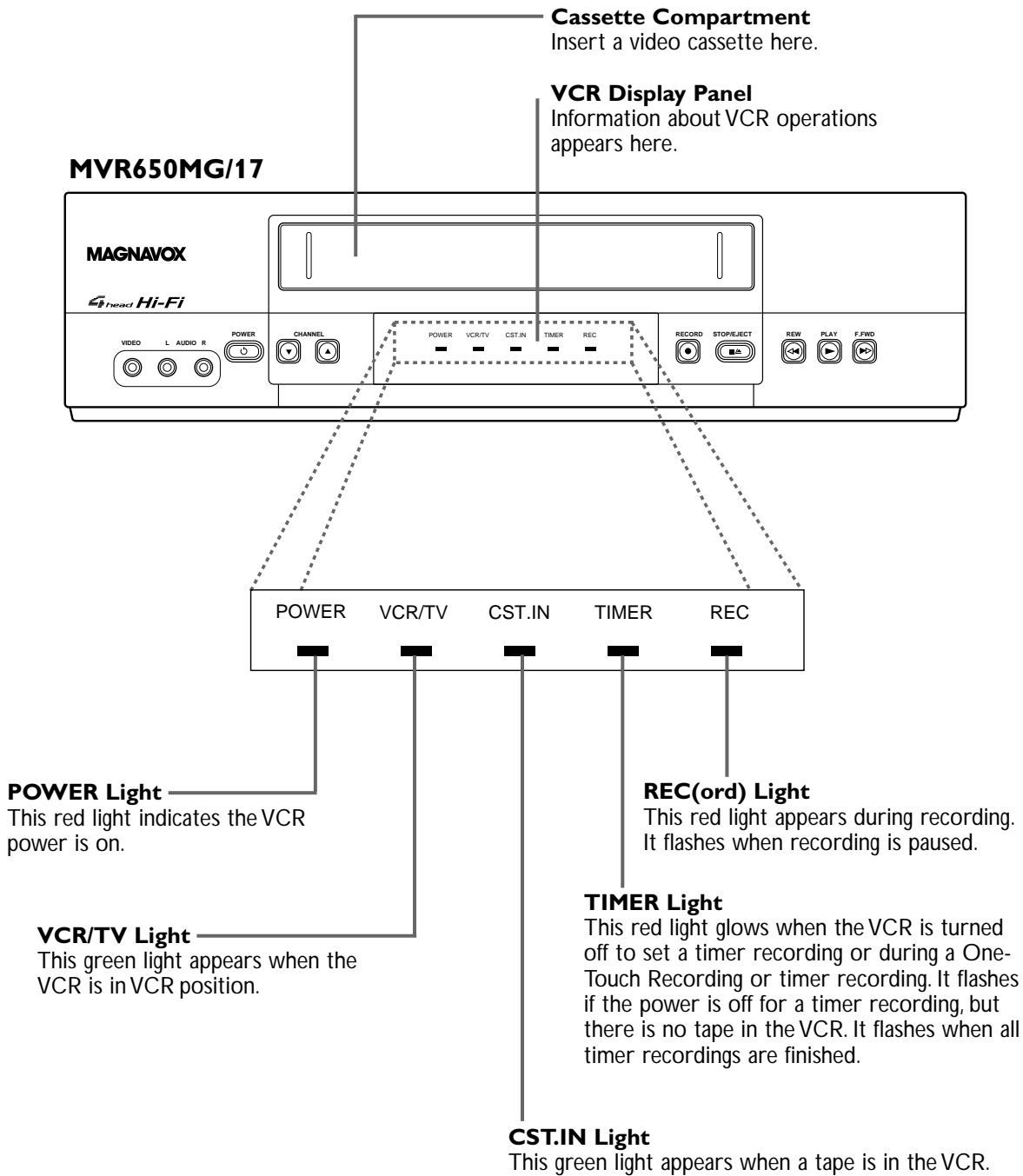

Front Panel 21

Remote Sensor

Receives a signal from your remote so you can operate your VCR from a distance.

CHANNEL ▲/▼ Buttons

Press to scan through the VCR's channels. During normal or slow motion play, press to adjust the tracking. See page 38.

POWER Button

Press to turn the VCR power on and off.

F.FWD (Fast Forward) Button

Press to fast forward a tape. See page 34. Press to select a menu item.

REW(ind) Button

Press to rewind the tape. See page 34. Press to go back one step in some menus.

MVR650MG/17

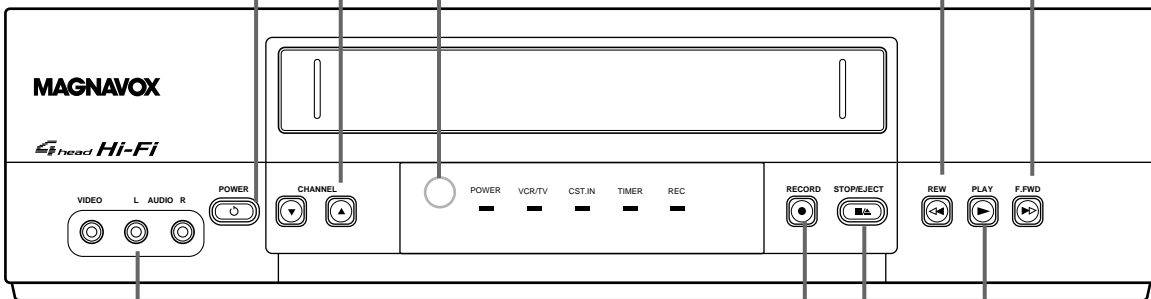

VIDEO/AUDIO In Jacks

Connect video and audio cables coming from the video and audio out jacks of a camcorder, another VCR, or other audio/video equipment here. See page 32. The MVR650MG/17 is shown here. The MVR440MG/17 and MVR450MG/17 have only one AUDIO IN Jack.

RECORD Button

Press once to start a recording. See page 24. Press repeatedly to start a timed One-Touch Recording. See page 25.

STOPEJECT Button

Press once to stop the tape. When play is stopped, press to eject the tape. Press to select an item in the VCR menu.

PLAY Button

Press to play a tape. Also, press to release Slow, Search, or Still mode and return to normal play. See page 34. Press to select an item in the VCR menu.

22 Rear Panel

ANT(enna) IN Jack

Connect your antenna or Cable TV signal here. See pages 6-10.

AUDIO IN Jacks

Connect the audio cables coming from the audio out jacks of a camcorder, another VCR, or an audio source here. See page 32.
The MVR650MG/17 is shown here. The MVR440MG/17 and MVR450MG/17 have only one AUDIO IN Jack.

AUDIO OUT Jacks

Connect the audio cables going to the audio in jacks of a camcorder, another VCR, a stereo amplifier, a TV, or an audio system here. See pages 10, 32, and 39.
The MVR650MG/17 is shown here. The MVR440MG/17 and MVR450MG/17 have only one AUDIO OUT Jack.

MVR650MG/17

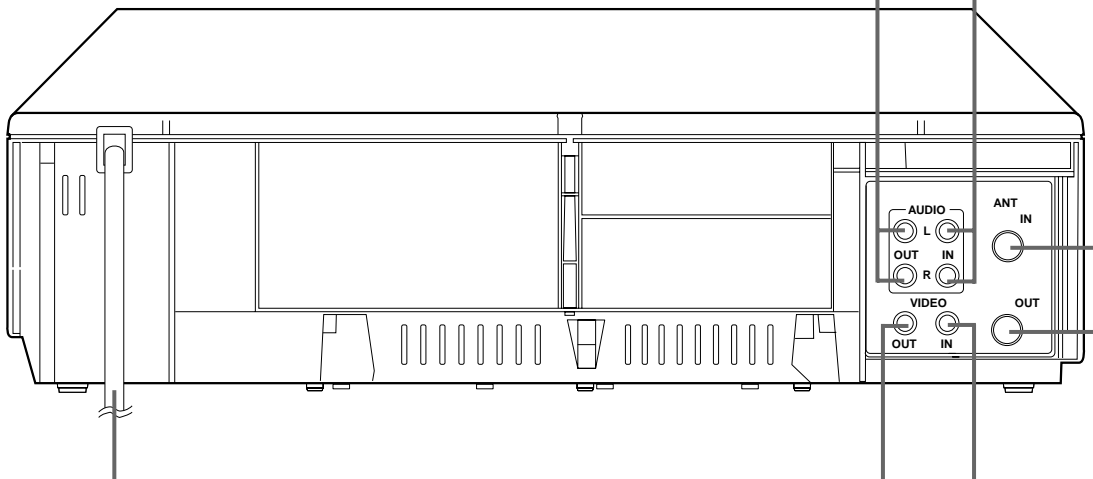

AC Power Cord

Connect to a standard AC outlet to supply power to the VCR.

VIDEO OUT Jack

Connect a video cable going to the video in jack of a camcorder, another VCR, a TV, or an audio-visual system (laser disc player, video disc player, etc.) here. See pages 10, 32, and 39.

VIDEO IN Jack

Connect a video cable coming from the video out jack of a camcorder, another VCR, or an audio-visual source (laser disc player, video disc player, etc.) here. See page 32.

OUT Jack

Use the supplied RF coaxial cable to connect this jack to the Antenna In Jack on your TV or Cable Box/Satellite. See pages six-nine.

Playing 23

Read and follow the steps below to play a tape.

- 1 Turn on the TV and set it to channel 3 or 4** (the VCR's RF output channel). (Press and hold PLAY during tape play for three seconds to switch the VCR's RF output channel to 3 or 4. Channel 3 is the default setting.)
- 2 Insert a tape in the VCR.** The POWER, VCR/TV, and CST.IN lights will appear. If the tape's record tab has been removed, play will begin automatically.
- 3 If play does not start automatically, press PLAY.**
- 4 Press STOP to stop play.**
- 5 Press REW to rewind the tape.**
- 6 Press EJECT to remove the tape.**

1 Turn on the TV.

2 Insert a tape.

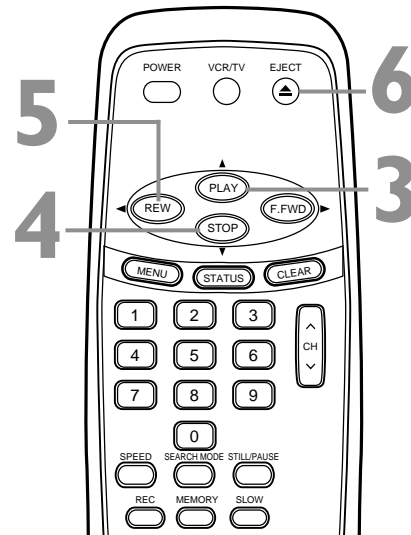

Helpful Hints

- If the tape you want to play is in the VCR, make sure the VCR power is on and the VCR is in VCR position. (Press VCR/TV so the VCR/TV light appears.) Press PLAY.
- Other playback options and features are on pages 33-41.
- If AUTO REPEAT is ON, play will begin automatically, even when the record tab is intact. See page 33.
- If you used audio and video cables to connect the VCR to the TV as shown on page 10, set the TV to its Video In or Auxiliary In channel instead. See your TV manual for details.

24 Recording

Read and follow the steps below to record a television program.

- 1 Turn on the TV; set it to channel 3 or 4** (the VCR's RF output channel). (Press and hold PLAY during tape play for three seconds to switch the VCR's RF output channel to 3 or 4. Channel 3 is the default setting.)
- 2 Insert a tape with its record tab intact (see page five) in the VCR.** The POWER, VCR/TV, and CST.IN lights will appear. If the VCR/TV light does not appear, press VCR/TV so the VCR/TV light appears.
- 3 Press SPEED until the desired tape speed (SP or SLP) appears on the screen.** The tape speed will disappear after about five seconds. You can change the tape speed while the VCR is recording, but some distortion may appear on the tape. See page 44.
- 4 Use CH \wedge/\vee or the Number buttons to select a channel to record.**
- 5 Press REC once to start recording.** The red REC(ord) light will appear. If the tape is missing the record tab, the VCR will eject the tape.
- 6 To pause recording (for example, during commercials), press STILL/PAUSE once.** The REC(ord) light will flash.
To resume recording, press REC or STILL/PAUSE again. The REC(ord) light will stay on.
- 7 Press STOP to stop recording.**

- 1 Turn on the TV.
- 2 Insert a tape.

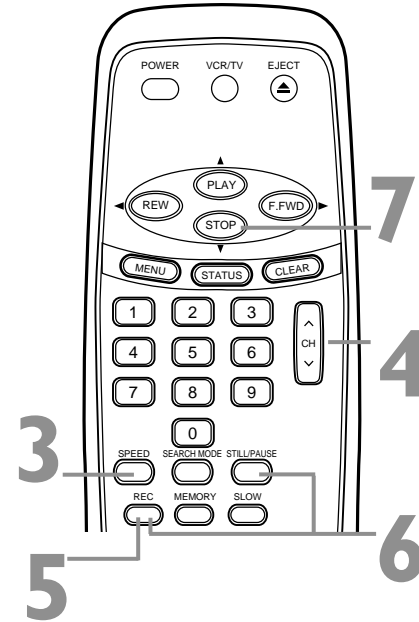

Helpful Hints

- Other recording options are on pages 25-32.
- The VCR will record in a preset volume.
- Pause will switch to Stop after five minutes to protect the VCR and the tape from damage. Review the pause time remaining with the ■ marks on the screen. Each ■ mark equals one minute. During the last minute of paused recording, the ■ mark will flash.
- You cannot start a recording if a VCR menu is on the TV screen.
- If you used audio and video cables to connect the VCR to the TV as shown on page 10, set the TV to its Video In or Auxiliary In channel instead. See your TV manual for details.

One-Touch Recording 25

One-Touch Recording lets you program an immediate timed recording 30 minutes to eight hours long. Make sure:

- Channels are set.
- The desired recording speed (SP, SLP) has been selected with SPEED.
- There is a tape in the VCR. Make sure the tape's record tab is intact and the tape is long enough to record the program(s).
- The VCR is in VCR position. (The VCR/TV light will appear. If it does not, press VCR/TV once.)

1 Use CH \wedge/\vee or the Number buttons to select the channel you want to record.

2 Press REC (or RECORD on the VCR) repeatedly until the desired recording length (30 minutes to eight hours) appears in the upper left corner of the screen. Recording will begin immediately. The TIMER and REC(ord) lights will appear on front of the VCR.

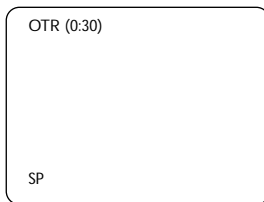

3 To stop an OTR before recording is finished, press STOP on the remote or STOP/EJECT on the VCR. To cancel the OTR but continue recording, press REC or RECORD repeatedly until REC appears in the upper left corner of the screen. When the OTR is finished, the VCR will eject the tape and turn itself off.

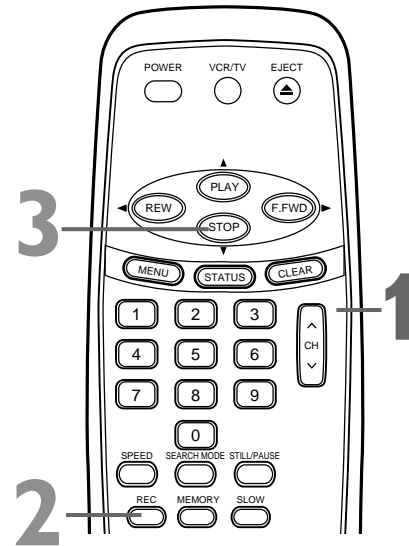

Helpful Hints

- To change the recording length while an OTR is in progress, press REC or RECORD repeatedly until the desired length appears on the screen.
- You cannot pause OTR recording.
- If the preset time for a timer recording comes up during an OTR, the OTR has priority. The timer recording will not occur.
- To show the time remaining for an OTR, press STATUS repeatedly until OTR and the time remaining appear on the screen.
- If the end of the tape is reached during an OTR, the VCR will stop recording, eject the tape, and turn itself off.

26 Timer Recording

Your VCR can record TV programs while you're away. You can program up to eight timer recordings. For each one, the VCR will turn itself on, record, and turn itself off. Make sure:

- Channels are set.
- The clock is set.
- There is a tape in the VCR. Make sure the tape's record tab is intact and the tape is long enough to record the program(s).
- The VCR is in VCR position. The VCR/TV light will appear. If it does not, press VCR/TV once.

- 1 Press MENU until MENU appears. Press PLAY or STOP to select TIMER PROGRAMMING. Press F.FWD.** Available program numbers will flash.

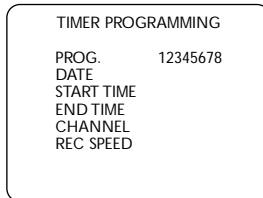

- 2 Press PLAY or STOP repeatedly to select a program number. Press F.FWD.** (If you select a program number that already has a timer recording stored, information about that program will appear. Press PLAY or STOP to select another program number.)

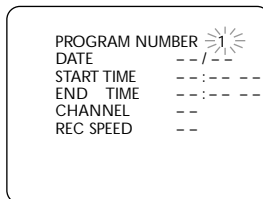

- 3 Press PLAY or STOP repeatedly to select a ONCE, DAILY, or WEEKLY recording. When the arrow is beside your choice, press F.FWD.**

- ONCE - The VCR will record a TV program on any day you choose, up to 12 months away.
- DAILY - The VCR will record a TV program at the same time on the same channel every day, Monday through Friday.
- WEEKLY - The VCR will record a TV program at the same time on the same channel every week, for example, every Monday.

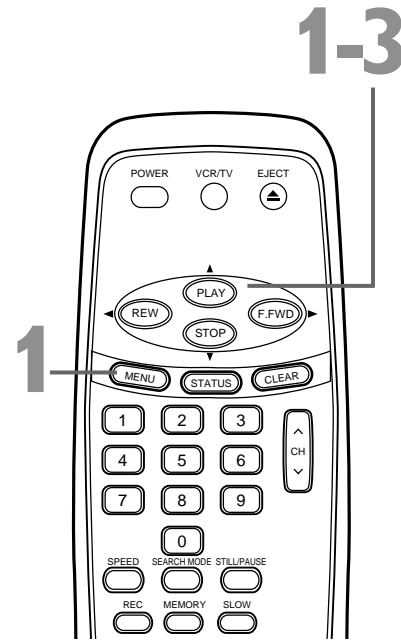
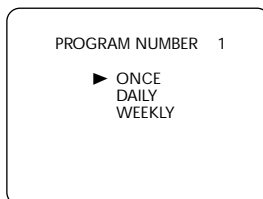

Helpful Hint

- Only programs that air Monday-Friday can be recorded on a DAILY basis. If you select DAILY at step 3, then enter a Saturday or Sunday DATE at step 4, the correct program will not record. The VCR will alter the recording date and record a different program than you intended.

Timer Recording (cont'd) 27

- 4** Enter the date of the recording. Press **PLAY** or **STOP** repeatedly until the desired month appears. Press **F.FWD**.
Next, press **PLAY** or **STOP** repeatedly until the desired day appears. Press **F.FWD**. The day of the week will appear. You cannot program the VCR to record more than one year in advance.

```

ONE TIME PROGRAM
PROGRAM NUMBER 1
DATE 05/04 TUE
START TIME --:--:--
END TIME --:--:--
CHANNEL --
REC SPEED --
    
```

- 5** Enter the recording's start time. Press **PLAY** or **STOP** repeatedly until the desired hour appears. Press **F.FWD**. Press **PLAY** or **STOP** repeatedly until the desired minute appears. Press **F.FWD**. Finally, press **PLAY** or **STOP** to point to **AM** or **PM**. **AM** or **PM** will flash beside the start time. Press **F.FWD**.

```

ONE TIME PROGRAM
PROGRAM NUMBER 1
DATE 05/04 TUE
START TIME 07:30 PM
END TIME --:--:--
CHANNEL --
REC SPEED --
                AM
                PM
    
```

- 6** Repeat the procedure in step 5 to set the recording's end time.

```

ONE TIME PROGRAM
PROGRAM NUMBER 1
DATE 05/04 TUE
START TIME 07:30 PM
END TIME 08:30 PM
CHANNEL --
REC SPEED --
                AM
                PM
    
```

4-6



Helpful Hints

- You cannot access the **TIMER PROGRAMMING** menu at step 1 if the clock is not set. The **CLOCK SET** menu will appear. See pages 14-15 to set the clock.
- Enter information while the space is flashing.
- Press **REW** to go back one step.
- To stop a started timer recording, press **STOP/EJECT** on the VCR. More Helpful Hints are on pages 42-43.

Instructions continue on page 28.

28 Timer Recording (cont'd)

- 7** Select the channel you want to record. **Press PLAY or STOP repeatedly until the desired channel number appears. Press F.FWD.**
- If you are using a standard antenna/Cable TV hookup (as shown on pages six-seven), select the channel of the TV program you want to record.
 - If you are recording from line input, select L1 (LineIn Rear) or L2 (LineIn Front). See the Helpful Hint below.
 - If you are using a Cable Box/Satellite, select the Cable Box/Satellite output channel (03 or 04). Then, at the Cable Box/Satellite, select the channel you want to record. Leave the Cable Box/Satellite on for the recording. See page eight.

```

ONE TIME PROGRAM
PROGRAM NUMBER  1
DATE            05 / 04 TUE
START TIME     07 :30 P M
END TIME       08 :30 P M
CHANNEL        16
REC SPEED      --
    
```

- 8** Press **PLAY or STOP** repeatedly to select a tape speed. The arrow will appear beside your choice. The selected tape speed will flash beside REC SPEED. See page 44.

```

ONE TIME PROGRAM
PROGRAM NUMBER  1
DATE            05 / 04 TUE
START TIME     07 :30 P M
END TIME       08 :30 P M
CHANNEL        16
REC SPEED      SP
    
```

- 9** Press **CLEAR** to save the timer recording.

- 10** Press **POWER** to turn off the VCR. The red TIMER light will appear. (It will flash if there is not a tape in the VCR.)

If the recording is several hours or days away, you may use the VCR until time for the recording. Just turn off the VCR about five minutes before the scheduled start time. The VCR will not remind you of upcoming recordings.

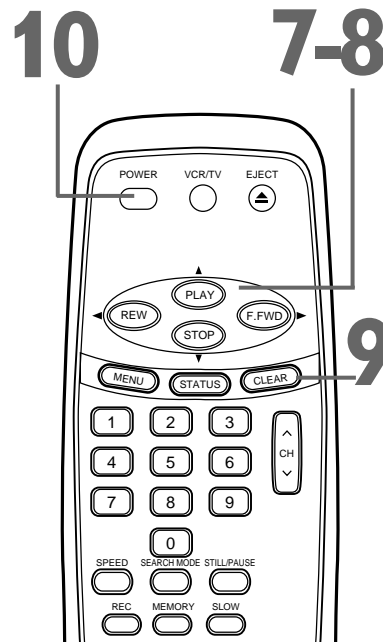

**Turn off the VCR for the recording.
Insert a tape in the VCR.
Leave the Cable Box/Satellite on
(if applicable).**

Helpful Hint

- When recording from line input (other equipment connected to the VCR), connect audio/video cables to the audio/video in jacks on the VCR. If you use the AUDIO/VIDEO In jacks on the front of the VCR, choose L2. If you use the AUDIO IN and VIDEO IN jacks on the back of the VCR, choose L1. (For example, see illustration on page 32.)

Timer Recording (cont'd) 29

..... Cancelling a Timer Recording

- 1** First, press **MENU** until **MENU** appears.
Press **PLAY** or **STOP** repeatedly to select **TIMER PROGRAMMING**. Press **F.FWD**.

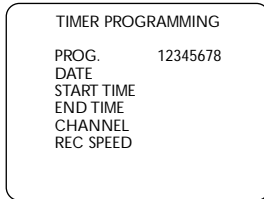

- 2** Press **PLAY** or **STOP** repeatedly to select the program you want to cancel.

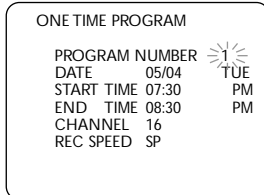

- 3** While the program number is flashing, press **REW** to cancel the timer recording.

- 4** Press **CLEAR** to remove the menu.

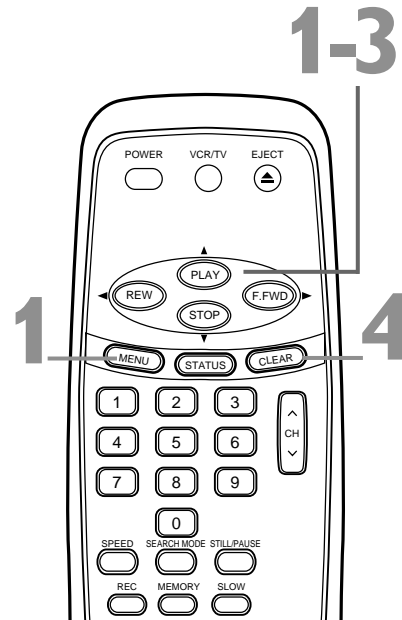

30 Timer Recording (cont'd)

Correcting a Timer Recording

You can correct a timer recording after you have finished setting it. Make sure the VCR is on and in VCR position. (The VCR/TV light will appear. If it does not, press VCR/TV once.)

1 First, press **MENU** until **MENU** appears. Press **PLAY** or **STOP** repeatedly to select **TIMER PROGRAMMING**. Press **F.FWD**.

2 Press **PLAY** or **STOP** repeatedly to select the timer recording you want to correct.

ONE TIME PROGRAM		
PROGRAM NUMBER	1	TUE
DATE	05/04	
START TIME	07:30	PM
END TIME	08:30	PM
CHANNEL	16	
REC SPEED	SP	

3 Select the information you want to change by repeatedly pressing **F.FWD**. Press **REW** to go back one step. (There is an exception. Do not press **REW** while the program number is flashing. This will cancel the timer recording completely.)

4 While the information is flashing, enter the correct information by pressing **PLAY** or **STOP**.

5 When all the information is correct, press **CLEAR** to save the timer recording. Turn off the VCR before the timer recording.

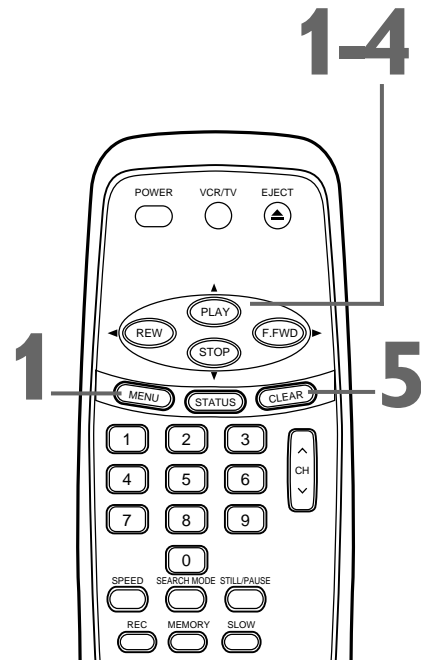

Recording One Channel/Watching Another 31

- 1 Press REC to start recording the current channel.**
See page 24.
- 2 Press VCR/TV to put the VCR in TV position.** The VCR/TV light will disappear.
- 3 Use the TV remote control to select the channel you want to watch at the TV.**
- 4 To return to the channel being recorded, use the TV remote control to select channel 3 or 4, whichever channel the RF output channel of the VCR is set to.** Choose the channel it was on before you changed it at step 3.
- 5 Press VCR/TV on the VCR's remote to put the VCR back in VCR position.** The green VCR/TV light will reappear. The channel being recorded will appear on the screen.
- 6 To stop recording, press STOP.**

- 3** Select the channel you want to watch at the TV.
- 4** Set the TV to channel 3 or 4.

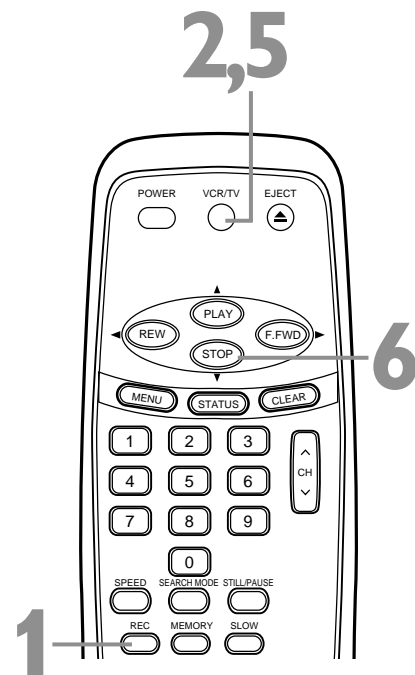

Helpful Hint

- If you use a Cable Box/Satellite, you may not be able to watch one channel while recording another. See pages eight-nine.

32 Rerecording (Tape Duplication)

These instructions show you how to copy tapes using two MVR650MG/17 VCRs. Different VCRs may operate differently.

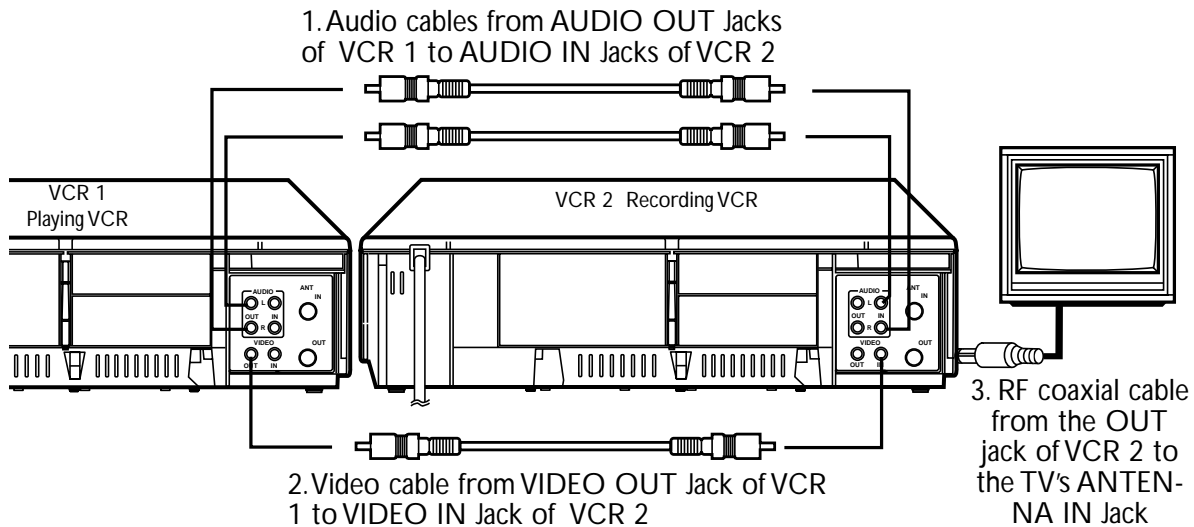

- 1 Make the connections shown above.**
- 2 VCR 1 will play your tape. Insert a prerecorded tape in VCR 1.** If the tape does not have a record tab, play begins. If this happens, press STOP/EJECT on VCR 1 once.
- 3 VCR 2 will record your tape. Insert a blank tape in VCR 2.** Make sure the record tab is intact (see page five). Make sure VCR 2 is on and in VCR position. (The green VCR/TV light will appear. If it does not, press VCR/TV once.)
- 4 Turn on the TV and set it to channel 3 or 4** (the RF output channel of VCR 2). See page seven.
- 5 Point the remote at VCR 2. Press 0, 0, 1 or 0, 0, 2.** (See Helpful Hints at right.)
- 6 Point the remote at VCR 2. Use SPEED to select SP or SLP.**
- 7 Press PLAY on VCR 1 and RECORD on VCR 2 at the same time.**
- 8 To stop recording, press STOP/EJECT on VCR 2 once, then stop the tape on VCR 1.**

Helpful Hints

- If you connected another VCR to the AUDIO/VIDEO IN jacks on the back of VCR 2, press 0, 0, 1 at step 5. L1 will appear on the TV.
- If you connected another VCR to the AUDIO/VIDEO In jacks on front of VCR 2, press 0, 0, 2 at step 5. L2 will appear on the TV.
- When the VCR is set to L1 or L2, the screen is blue.
- Unauthorized recording of copyrighted TV programs, video tapes, or other materials may infringe on the rights of copyright owners and violate copyright laws. A copy-protected program will not record clearly.
- Audio and video cables are not supplied.
- If you have the MVR440MG/17 or MVR450MG/17, connect one audio cable to the AUDIO OUT jack on VCR1 and to the AUDIO IN jack on VCR2.

Repeat Play 33

Follow the steps below to program the VCR to play a tape over and over. Make sure:

- The VCR is on and is in VCR position. The VCR/TV light will appear on the front panel. If it does not, press VCR/TV once.
- There is a tape in the VCR.

1 Press MENU until MENU appears.

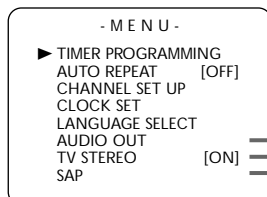

MVR650MG/17 only

2 Press PLAY or STOP repeatedly to select AUTO REPEAT.

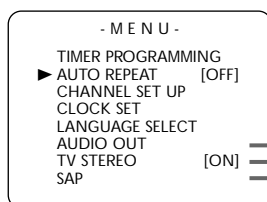

MVR650MG/17 only

3 Press F.FWD so [ON] appears beside AUTO REPEAT.

Tape play will begin immediately. AUTO REPEAT ▶ will appear on the screen briefly.
(If you are fast forwarding or rewinding the tape, you must first press CLEAR to remove the menu, then press PLAY to play the tape.)

The VCR will play the tape to the end, rewind it, then play it again. (TV programming will appear on the screen while the tape is rewinding.)

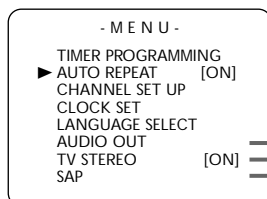

MVR650MG/17 only

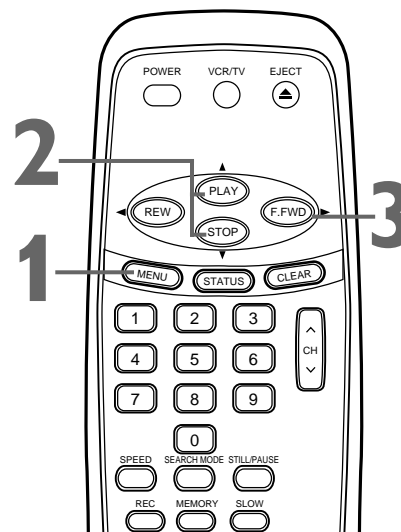

Helpful Hints

- To cancel AUTO REPEAT, follow steps 1-2 above. At step 3, press F.FWD so [OFF] appears beside AUTO REPEAT. Press CLEAR to remove the menu.
- MEMORY does not function if AUTO REPEAT is [ON].
- The real-time counter memory is cancelled if AUTO REPEAT is [ON].

34 Special Effects Playback

Forward and Reverse Searching

- 1 During tape play, press and release F.FWD or REW.** A fast forward or reverse picture search will begin.
- 2 Press F.FWD or REW again.** The VCR will search in super high speed. (This is possible only for tapes recorded in LP or SLP speeds.) Each press of F.FWD or REW alternates the search speed.
- 3 To return to play, press PLAY.**

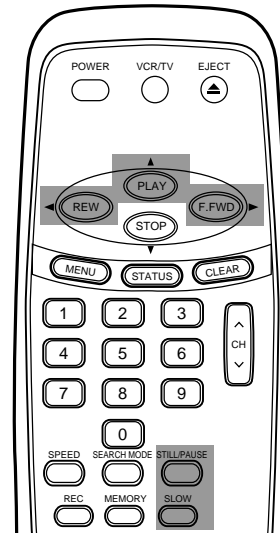

Viewing a Still Picture

- 1 During play, press STILL/PAUSE** to freeze the picture. Advance the still picture one frame at a time by pressing STILL/PAUSE repeatedly.
- 2 To release the still picture and return to normal play, press PLAY.**

Viewing a Slow Motion Picture

- 1 During tape play, press SLOW.** The tape will play in slow motion.
- 2 To release Slow mode and return to normal play, press PLAY.**

Helpful Hint

- *Slow and Still modes will automatically switch to Stop mode after five minutes to protect the VCR and the tape from damage.*

Real-Time Counter Memory 35

You can reset the real-time counter to zero at a tape location you want to refer to later. Make sure:

- The VCR is on and is in VCR position. The VCR/TV light will appear. If it does not, press VCR/TV once.
- There is a tape in the VCR.

1 Play, fast forward, or rewind a tape to the location that you would like to refer to later. **Press STOP to stop the tape.**

2 Press **CLEAR** (repeatedly if necessary) to reset the real-time counter to zero.

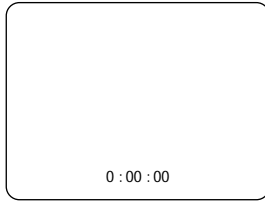

3 Press **MEMORY** so **M** appears on the screen beside the real-time counter.

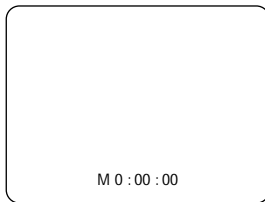

4 To go to a tape location where the counter was reset to zero, press **REW** or **F.FWD** when play is stopped. When the tape reaches zero, it will stop. **Press PLAY** to watch the tape.

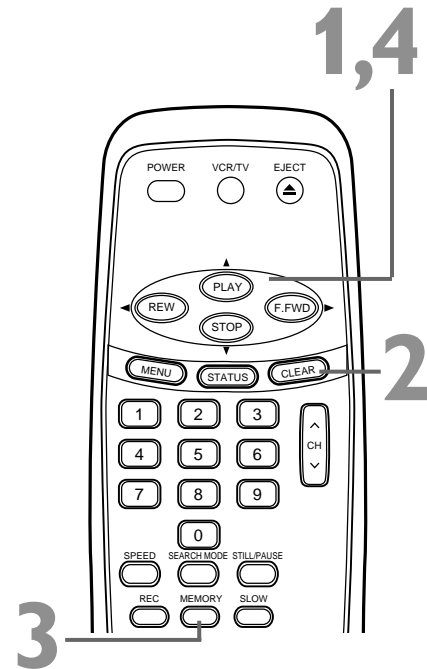

Helpful Hints

- Set the counter memory at one location at a time. Setting the counter to zero at a second location will erase the previous setting.
- To erase the counter memory, press **MEMORY** repeatedly so the **M** disappears from the screen.
- **MEMORY** does not function if **AUTO REPEAT** is [ON]. See page 33.

36 Time Search

Time Search lets you go to a specific point on a tape. Enter the amount of time you wish to skip in order to reach the specified point. Make sure:

- The VCR is on and is in VCR position. (The VCR/TV light will appear. If it does not, press VCR/TV once.)
- There is a tape in the VCR.

- 1 Press SEARCH MODE until TIME SEARCH appears.**

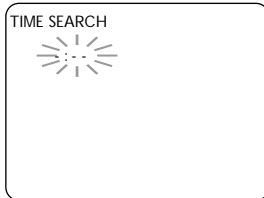

- 2 Within 30 seconds, press PLAY or STOP repeatedly until your desired length of time appears. Or, press and hold PLAY or STOP until you reach the length of time.**

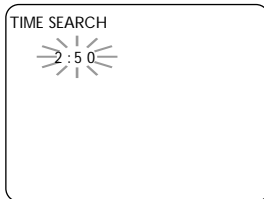

- 3 Within 30 seconds, press REW or F.FWD.** The VCR begins rewinding or fast forwarding to the specified point. The time counts down on the screen beneath TIME SEARCH as the searching progresses. When the tape finishes rewinding or fast forwarding, the VCR will start play automatically.

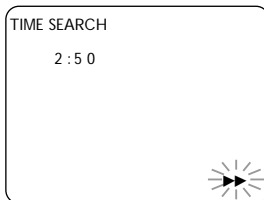

2-3

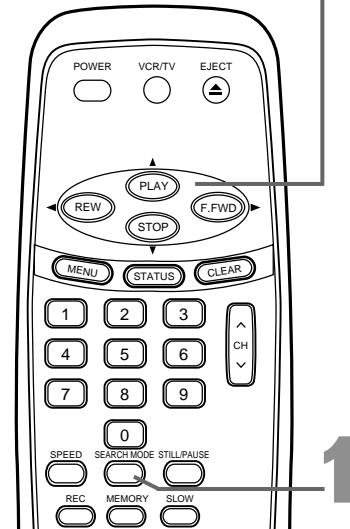

Helpful Hints

- You can set a Time Search for up to 9 hours, 59 minutes (9:59).
- Time Search is not available during recording.
- To exit Time Search mode, press CLEAR.
- To cancel a Time Search in progress, press STOP.
- If the end of the tape is reached during a Time Search, the VCR will cancel the search and rewind the tape. See page 38.

Index Search 37

When you make a recording, the VCR places an index mark at the beginning of the recording. Essentially, an index mark is a type of "bookmark" for your tape. This feature is useful if you have several different programs recorded on a single tape. Skip over programs by following the steps below. Before you begin, make sure:

- The VCR is on and is in VCR position. (The VCR/TV light will appear. If it does not, press VCR/TV once.)
- There is a tape in the VCR.

1 Press SEARCH MODE until INDEX SEARCH appears.



2 Within 30 seconds, press PLAY or STOP repeatedly until the number of programs that you want to skip appears beneath INDEX SEARCH.

This number should include the current program. For example, if you are currently viewing program 2 and you want to skip to program 5, select 03 to skip three programs (2, 3, and 4). Playback will begin at program 5. If you want to skip to program 1, select 02 to skip two programs (2 and 1). Playback will begin at program 1.

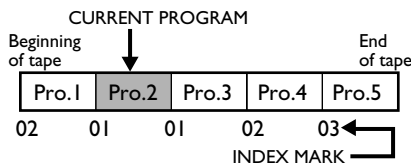
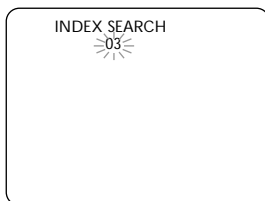

3 Within 30 seconds, press REW or F.FWD. The VCR rewinds or fast forwards to the beginning of the program. When the program is reached, play will begin.

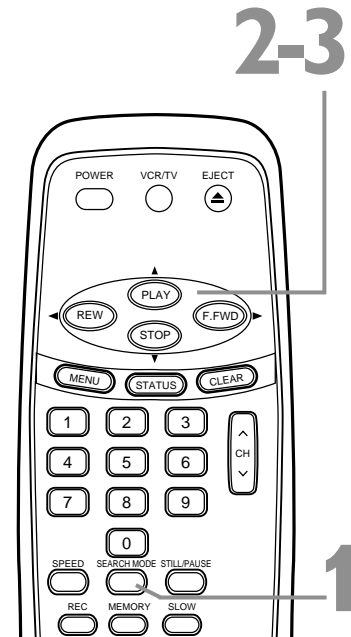
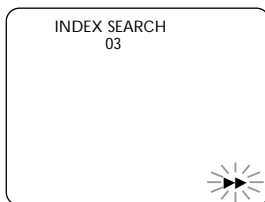

Helpful Hints

- When an index mark is passed during rewinding or fast forwarding, the number of programs beneath INDEX SEARCH decreases by one.
- Up to 20 index marks may be searched.
- This function is not available during recording.
- Press STOP to stop the search.
- To exit Index Search, press CLEAR.
- The time gap between index marks should be greater than 1 minute for SP recording, 2 minutes for LP recording, and 3 minutes for SLP recording.
- If the end of the tape is reached during an Index Search, the VCR will cancel the search and rewind the tape. See page 38.

38 Automatic Playback Features

Automatic Playback

When you put a tape in the VCR, the power will come on automatically. If the tape's record tab is missing, play will begin. (If a timer recording is set, you may have to press POWER to turn on the VCR. Turn off the VCR for the timer recording later. If you insert a tape without a record tab when a timer recording is set, the VCR will eject the tape.)

Automatic Rewind, Eject, Off

When a tape is played, fast forwarded, or recorded to its end, the VCR will rewind the tape to the beginning, eject the tape, and turn itself off.

If the real-time counter memory is set, the VCR will only rewind the tape to the point at which the counter is set to zero, then stop. The VCR will not eject the tape or shut itself off.

Tape Eject

A tape can be ejected with the VCR power on or off (but the VCR must be plugged in). If a Timer Recording is programmed, a tape can only be ejected with the power on. Be sure to insert a tape for the Timer Recording, then turn off the VCR power.

Tracking

The VCR automatically adjusts tracking to give you the best possible picture quality during normal play. With some recordings, you may get a better picture using manual tracking.

To adjust the tracking manually, press CH \wedge/\vee on the remote or CHANNEL $\blacktriangle/\blacktriangledown$ on the VCR during normal or slow motion play.

NOTES:

- Tracking returns to automatic tracking adjustment when you insert a tape or stop play.
- Use CHANNEL $\blacktriangle/\blacktriangledown$ on the VCR or CH \wedge/\vee on the remote to remove vertical jitter in a Still picture.

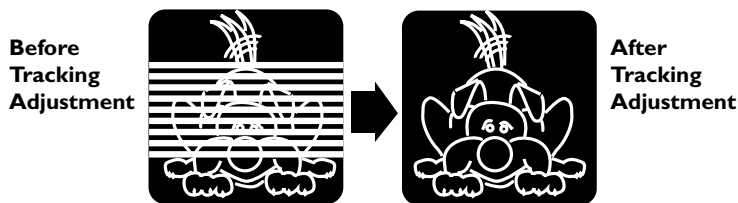

MTS Broadcast Stereo (MVR650MG/17) 39

Your VCR can play recordings broadcast in Hi-Fi (high fidelity) stereo, which produces a crisp, clear sound from two sources. Your VCR also can play tapes recorded in a second audio (usually, that means your program is recorded in a second language). Of course, your VCR will play tapes recorded in monaural (single-source) sound as well.

Your VCR also will record in Hi-Fi stereo or in second audio, so when you play back that tape on the VCR, it will be in stereo or second audio.

Read the directions on this page to familiarize yourself with your VCR's stereo and second audio setups. Then follow the directions on page 40 to record in stereo or second audio and the directions on page 41 to play back tapes recorded in Hi-Fi stereo.

Understanding On-Screen Displays

When you receive a signal from a channel you're watching, portions of the on-screen display shown below will appear when you press STATUS on the remote.

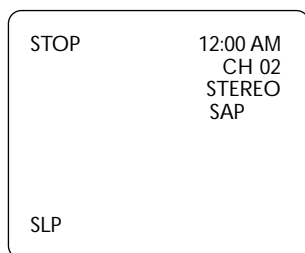

The indication SAP or STEREO that appears on the status display tells you if the program you're watching is available in second audio or stereo. Even though a program is available in second audio or stereo, you still must program the VCR to receive or record the program. Follow the directions on page 40. This indication is not available during tape play.

To record and play back programs broadcast in stereo, even if you have a Single Speaker TV, just use one of the connections shown, then follow the steps on pages 40-41.

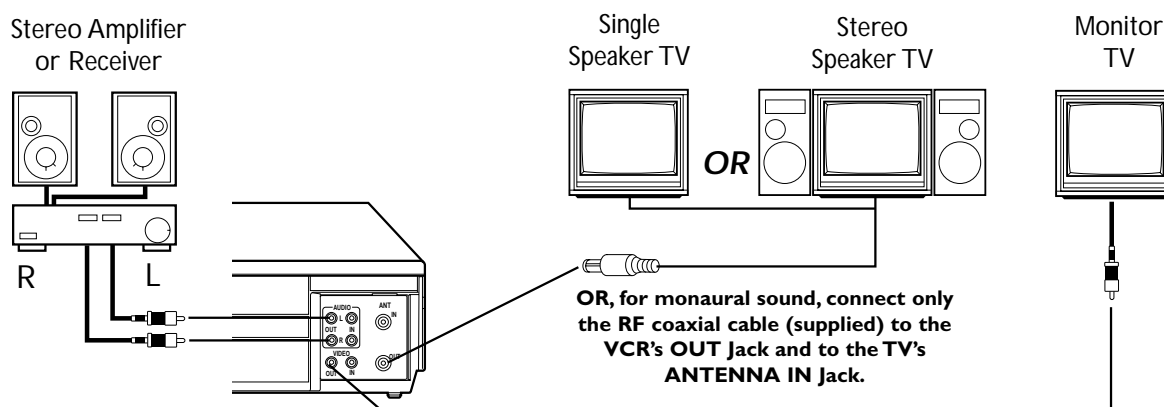

For stereo sound, connect the audio cables to the AUDIO OUT Jacks on the VCR and to the AUDIO IN Jacks on the Stereo Amplifier or Receiver. Then, connect the video cable to the VIDEO OUT Jack of the VCR and to the VIDEO IN Jack of a monitor TV.

40 MTS Broadcast Stereo (MVR650MG/17) (cont'd)

Make sure:

- The VCR is on and is in VCR position. The VCR/TV light will appear. If it does not, press VCR/TV once.

1 Press MENU until MENU appears.

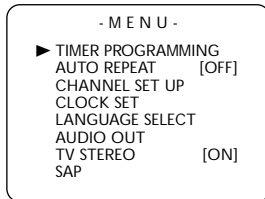

2 Press PLAY or STOP repeatedly to select TV STEREO or SAP. Press F.FWD, then [ON] will appear beside your selection.

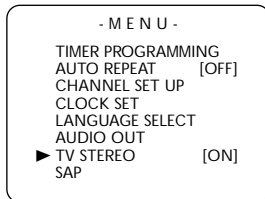

3 Press CLEAR to remove the menu.

4 To play a tape, press PLAY. To record, use CH ^/v to select a channel, then press REC.

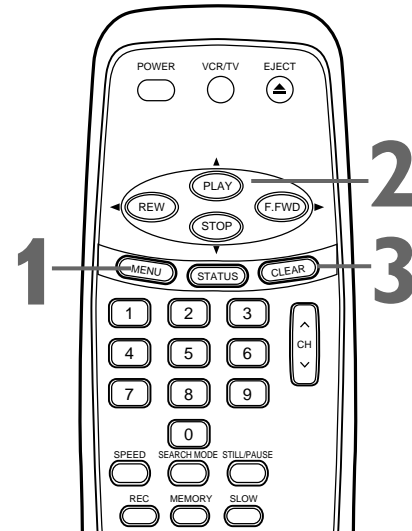

Helpful Hints

- You can only receive and record stereo or second audio if included by the program. You can only play in stereo or second audio tapes that were recorded that way. See page 39 to determine if the program is broadcast in stereo or second audio.
- If you select second audio when it is not available, the VCR will record normal audio.

Hi-Fi Stereo (MVR650MG/17) 41

Multi-Channel Television Sound records in Hi-Fi stereo. To play tapes in Hi-Fi stereo, follow these steps. Make sure:

- The VCR is on and is in VCR position. The VCR/TV light will appear. If it does not, press VCR/TV once.

1 Press MENU until MENU appears.

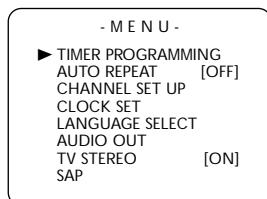

2 Press PLAY or STOP repeatedly to select AUDIO OUT. Press F.FWD.

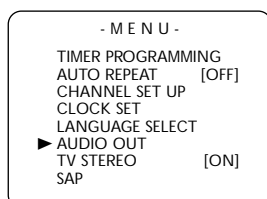

3 Press PLAY or STOP repeatedly to select HIFI. [ON] will appear beside HIFI.

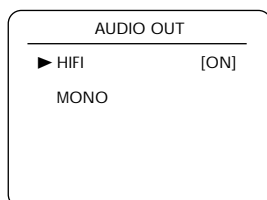

4 Press CLEAR to remove the menu.

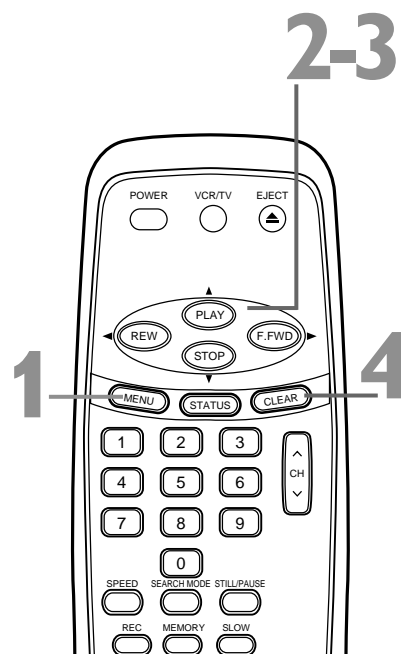

Helpful Hints

- All programs record in both Hi-Fi stereo and monaural sound.
- The audio level of a tape recorded in Hi-Fi stereo will differ from the audio level of a tape not recorded in Hi-Fi stereo.
- You can set AUDIO OUT to MONO if you want monaural audio playback. Follow steps 1-2 above. At step 3, press PLAY or STOP repeatedly to select MONO. Press CLEAR to remove the menu.
- If you play non-Hi-Fi tapes while AUDIO OUT is set to HIFI, HIFI will not appear on the status display. The tape will play in monaural sound.

For more hints, see page 43.

42 Helpful Hints

If you are having problems with your product, check this list of problems and possible solutions before requesting service. You may be able to solve the problem yourself.

If you need to call a customer service representative, please know the model number and serial number of your product before you call. This information is displayed on the back of the product.

The VCR has no power.

- Make sure the power plug is connected to an AC (alternating current) outlet.
- Make sure the power is on.

A power failure occurred.

- See *page 11* to select a language and set up channels. See *pages 14-15* to reset the clock.
- Timer recordings are lost if a power failure exceeds 30 seconds. Reset the recordings. See *pages 26-30*.

The remote will not operate the VCR.

- Aim the remote directly at the VCR's remote sensor. See *page 21*.
- Remove all obstacles between the remote and the VCR.
- Inspect and/or replace the batteries in the remote control. See *page five*.

The VCR does not respond normally to the remote.

- Install new batteries (preferably alkaline) in the remote control.

The motor (cylinder) rotates even when the VCR is in Stop mode.

- To enable quick play, the cylinder will rotate for about five minutes. This is normal.

A TV program cannot be recorded.

- Check the connections between the VCR, TV, antenna/Cable TV signal, and Cable Box/Satellite. See *pages 6-10*.
- Make sure the tape has a record tab. See *page five*.

The VCR will not perform a timer recording.

- Make sure the start and end times are correct. See *pages 26-30*.
- Make sure a tape is in the VCR and the tape has a record tab. See *page five*.
- Make sure the VCR power is off. The VCR will not remind you of an upcoming timer recording if the VCR power is on.
- Make sure the clock is set. See *pages 14-15*.
- The VCR may not complete a timer recording if the power fails for more than 30 seconds before or during the recording, even if the power is restored. Set up channels and reset the clock before resetting the recording(s).
- Finish programming a timer recording at least five minutes before it is scheduled to begin.
- If, after programming a timer recording, you turn off the VCR without inserting a tape, the red TIMER light will blink. Insert a tape with the record tab intact. If a tape without a record tab is inserted (when the power is off for a timer recording), the VCR will eject the tape. The TIMER light will blink.
- Noon is 12 p.m. Midnight is 12 a.m.
- If the tape runs out before the recording ends, the VCR will stop, eject the tape, and turn itself off. The red TIMER light will blink.
- If the preset time for a timer recording comes up during a One-Touch Recording, the OTR has priority.
- When two timer recordings overlap, the recording with the earliest start time has priority. When the earliest program finishes recording, the next program will record (only the time remaining).

Tape cannot be removed.

- Make sure the power plug is connected to an AC (alternating current) outlet.
- If a timer recording is set, turn on the VCR and eject the tape. Insert a tape and turn off the VCR again for your timer recording.

Helpful Hints (cont'd) 43

Tape cannot be inserted.

- Insert the tape, window side up, with the record tab facing you and on the left.
- Make sure a tape isn't already in the VCR by pressing STOP/EJECT on the VCR or EJECT on the remote.
- Gently push on the center of the tape when putting it in the VCR. Never force the tape into the VCR.
- If a timer recording is set and the VCR power is off, the VCR will not accept a tape that does not have a record tab. You may only insert a tape with the record tab intact.

The tape ejects if you press REC or turn off the VCR for a timer recording.

- Make sure the tape has a record tab. See *page five*.

There is no picture or the picture is noisy or contains streaks.

- Set the TV to channel 3 or 4. See *page seven*. Adjust channel 3 or 4 at the TV.
- If you used audio and video cables to connect the VCR to the TV as shown on page 10, select the Video In channel at the TV.
- Set the VCR to VCR position. (The green VCR/TV light will appear. If it does not, press VCR/TV once.)
- Adjust the tracking. See *page 38*.
- TVs placed too close to the VCR can cause interference during play. Move the VCR away from the TV.

TV programs cannot be watched normally.

- Press VCR/TV to put the VCR in TV position. (The VCR/TV light will disappear.)
- Check the connections between the VCR, TV, antenna/Cable TV signal, and Cable Box/Satellite. See *pages 6-10*.

The reception on all channels is poor.

- You may need to tune your TV again.

Line Input

- If you accidentally enter Line Input mode (LineIn Rear (L1) or LineIn Front (L2)) will appear on your TV briefly, use CH \wedge / \vee or the Number buttons to select another channel.

The picture is too dim, too bright, or fluctuates in brightness.

- Some programs may be broadcast with copyright protection technology in order to protect the rights of copyright owners. This technology is used on programs that are recorded on video tapes or Digital Video Discs (DVDs), as well as some programs broadcast by antenna/cable/satellite television channels. Programs broadcast with copyright protection technology may not record clearly. Likewise, if you play a tape that is a recording of a copyright protected program, the picture may not be clear. Tapes of copyright protected programs may have a picture that is dark or dim, or the brightness of the picture may fluctuate. Therefore, you should avoid recording or playing copies of copyright protected programs.
This VCR incorporates copyright protection technology that is protected by method claims of certain U.S. patents and other intellectual property rights owned by Macrovision Corporation and other rights owners. Use of this copyright protection technology must be authorized by Macrovision Corporation and is intended for home and other limited viewing uses only, unless otherwise authorized by Macrovision Corporation. Reverse engineering or disassembly is prohibited.

Hi-Fi Stereo Sound (MVR650MG/17 only)

- During play, Hi-Fi audio may temporarily revert to normal audio when you adjust tracking. This is normal.
- When connecting the VCR to a stereo TV, you only get stereo sound if you use audio cables to connect the VCR's AUDIO OUT jacks to the TV's AUDIO IN jacks. Put the TV in Line Input mode. Your TV may refer to this as an Audio/Video In channel, or A/V In, External In, Auxiliary In, etc. Such channels are usually located near channel zero (0). Or, your TV remote may have a button or switch that selects different Video or Auxiliary channels. See your TV manual for details.
When you make this connection, the stereo light on the TV might not glow. But, if the VCR status display indicates you are receiving a stereo signal, you are. This is normal.
- Only tapes recorded in Hi-Fi audio will play in Hi-Fi audio. Tapes recorded in normal audio will play in monaural audio.

44 Glossary

AUDIO IN/OUT Jacks: jacks on the front and back of the VCR that record audio from another source (IN) or send audio to another system (OUT).

The MVR440MG/17 and MVR450MG/17 have a single AUDIO IN jack on the front and back of the VCR and a single AUDIO OUT jack on the back of the VCR. The MVR650MG/17 has Right and Left AUDIO IN jacks on the front and back of the VCR and Right and Left AUDIO OUT jacks on the back of the VCR.

Automatic Channel Setup: process in which the VCR scans all available channels and places the ones you receive in its memory. When you use CH \wedge/\vee , you only scan channels you receive.

Bands: settings that allow you to tune channels.

- **Antenna** – VHF (very high frequency; channels 2-13) and UHF (ultra high frequency; channels 14-69).
- **Cable** – Standard channels 1-125 can be received without a Cable Box/Satellite.

Cable Box/Satellite Output Channel: Channel 3 or 4.

Dubbing: copying a tape using a second VCR.

Frame: a single still picture.

HQ: high quality; a feature in the VCR circuitry which provides enhanced picture detail.

Line Input: The channel to which you set your VCR during dubbing. If you use the AUDIO and VIDEO In jacks on the front of the VCR, select channel 002 (LineIn Front (L2)).

If you use the AUDIO and VIDEO IN jacks on the back of the VCR, select channel 001 (LineIn Rear (L1)).

If you accidentally enter Line Input mode, press CH \wedge/\vee or the Number buttons to select another channel.

OTR: One-Touch Recording; a timed recording that starts immediately and records for 30 minutes to eight hours, whichever you specify.

Remote Control: the small electronic unit that came with your VCR; allows you to operate your VCR from a distance.

RF coaxial cable: The cable supplied with your VCR. Use it to connect your VCR to your TV (or Cable Box/Satellite, if applicable). The supplied cable is a snap-on type. However, you may also use a screw-on type if you prefer.

Special Effects: forward and reverse searching; a still picture; slow motion play.

Tape Speeds: how fast the tape travels during a recording or during play.

- SP (standard play) – fastest tape speed (recording time for a T120 tape is approximately two hours); best picture quality.
- LP (long play) – average tape speed; play only.
- SLP (super long play) – slowest tape speed (recording time for a T120 tape is approximately six hours). Allows the most recording time per tape.

VIDEO IN/OUT Jacks: jacks on the front and back of the VCR which record video from another source (IN) or send video to another system (OUT).

Specifications 45

Video Heads

Four heads – Hi-Fi (MVR650MG/17)
Four heads (MVR440MG/17 and MVR450MG/17)

Video Signal

EIA standards; NTSC color

Antenna

VHF/UHF – 75 ohm external antenna terminal

VHF Output Signal

Channel 3 or 4 (switchable)
75 ohms unbalanced

Power Requirement

120V AC; 60Hz

Power Consumption

14W

Operating Temperature

41°F (5°C) to 104°F (40°C)

Relative Humidity

10% to 80%

Weight

4.18 lbs. (1.9 kg.)

Dimensions

14.2" (W) x 3.6" (H) x 8.5" (D)
(360mm x 92mm x 216mm)

Tuner Broadcast Channels

VHF 2-13, UHF 14-69

Cable TV Channels

1-125

NOTE: Designs and specifications are subject to change without notice.

MAGNAVOX LIMITED WARRANTY

Ninety (90) Days Free Product Exchange

MAGNAVOX warrants this product against defect in material or workmanship, subject to any conditions set forth as follows:

PROOF OF PURCHASE:

You must have proof of the date of purchase to exchange the product. A sales receipt or other document showing the product and the date that you purchased the product as well as the authorized retailer included, is considered such proof.

COVERAGE:

Warranty coverage begins the day you buy the product. For a period of ninety (90) days from the date of purchase, if the product is determined to be defective, Magnavox will exchange the defective product with a new or renewed product, at its option, at no charge. The replacement product is covered only for the warranty period of the original product. When the warranty on the original product expires, the warranty on all replaced products also expires. When it is necessary for you to ship the product to Magnavox for exchange, you will pay the shipping cost for shipment to Magnavox. Magnavox will pay the shipping costs when returning a product to you.

Note: The exchange model supplied will be the most comparable one in Magnavox current inventory. Shipping of your product to Magnavox implies intent to follow the specified requirements of the warranty and exchange program. Product received by Magnavox cannot be returned. Replacement product can only be sent if all warranty requirements are met. Failure to follow all requirements can result in delay of exchange process.

EXCLUDED FROM WARRANTY COVERAGE

Your warranty does not cover:

- Shipping charges to return defective product.
- Labor charges for installation or setup of the product, adjustment of customer controls on the product, and installation or repair of antenna systems outside of the product.
- Product repair and/or part replacement because of improper installation, connections to improper voltage supply, abuse, neglect, misuse, accident, unauthorized repair or other cause not within the control of Magnavox.
- A product that requires modification or adaptation to enable it to operate in any country other than the country for which it was designed, manufactured, approved and/or authorized, or repair of products damaged by these modifications.
- Damage occurring to product during shipping when improperly packaged or cost associated with packaging.
- Product lost in shipment and no signature verification of receipt can be provided.
- A product used for commercial or institutional purposes (including but not limited to rental purposes).
- Product sold AS IS or RENEWED.

WHERE WARRANTY EXCHANGE IS AVAILABLE:

Exchange is available in all countries where Magnavox officially distributes the product. In countries where Magnavox does not distribute the product, the local Magnavox organization will attempt to exchange the product, although there may be a delay if the appropriate product is not readily available or special customs processes are implied.

FOR EXCHANGE IN THE U.S.A., PUERTO RICO, OR U.S. VIRGIN ISLANDS...

Contact Magnavox Customer Care Center at:
1-800-705-2000

FOR EXCHANGE IN CANADA...

1-800-661-6162 (French Speaking)
1-800-705-2000 (English or Spanish Speaking)

REPLACEMENT AS PROVIDED UNDER THIS WARRANTY IS THE EXCLUSIVE REMEDY FOR THE CONSUMER. MAGNAVOX SHALL NOT BE LIABLE FOR ANY INCIDENTAL OR CONSEQUENTIAL DAMAGES FOR BREACH OF ANY EXPRESS OR IMPLIED WARRANTY ON THIS PRODUCT. EXCEPT TO THE EXTENT PROHIBITED BY APPLICABLE LAW, ANY IMPLIED WARRANTY OF MERCHANTABILITY OR FITNESS FOR A PARTICULAR PURPOSE ON THIS PRODUCT IS LIMITED IN DURATION TO THE DURATION OF THIS WARRANTY.

Some states do not allow the exclusions or limitation of incidental or consequential damages, or allow limitations on how long an implied warranty lasts, so the above limitations or exclusions may not apply to you. In addition, if you enter into a service contract agreement with the MAGNAVOX partnership within ninety (90) days of the date of sale, the limitation on how long an implied warranty lasts does not apply.

This warranty gives you specific legal rights. You may have other rights which vary from state/province to state/province.

Magnavox, P.O. Box 671539, Marietta, GA. 30006-0026

(Warranty: 4835 710 27750)

47 Index

- ac power cord7, 22
- accessories3
- ant(enna) in jack6-10, 22
- audio in/out jacks
 -10, 21, 22, 32, 39, 44
- automatic
 - playback38
 - rewind, eject, off38
- batteries5
- cassette compartment20
- ch ^/v button18
- channel
 - adding13
 - deleting13
 - setup11, 12
 - ^/v button18
 - ▲▼ buttons21
- clear button19, 35
- clock on-screen display17
- clock (setting)14-15
- connections6-10, 32, 39
- controls
 - remote5, 18-19
 - vcr20-21
- copyright protection32, 43
- count on-screen display17
- cst. in light20
- display panel20
- duplication32
- eject button18
- f.fwd button19, 21
- front panel21
- glossary44
- helpful hints42-43
- hi-fi stereo sound41
- hookups
 - for tape duplication32
 - with a cable box/satellite8-9
 - with a stereo39
 - with a stereo tv10, 39
 - without a cable box/satellite 6-7
- index search37
- language selection11, 16
- line input mode12, 32, 43
- long play44
- lp44
- memory button18, 35
- menu (front panel access)21
- menu button18
- number buttons18
- on-screen status displays17
- one-touch recording25
- out jack7-9, 22, 32
- play button18, 21, 23, 34
- playing a tape23
- power
 - button18, 21
 - cord7, 22
 - light20
- rear panel22
- rec button18
- rec(ord) light20
- record button21
- record tab5
- recording
 - basic24
 - one channel/watching another ..31
 - prevention5
 - timer26-30
- remote control
 - buttons18-19
 - sensor5, 21
 - using5
- repeat play33
- rerecording32
- rew button19, 21
- rf coaxial cable3, 7-9, 32, 39
- safety precautions3
- search mode button19, 36-37
- searching
 - forward/reverse34
 - index37
 - time36
- second audio broadcast
 - receiving39-40
 - recording39-40
- sensor (remote)5, 21
- slow
 - button18, 34
 - motion34
- slp24, 44
- sp24, 44
- speed button19, 24
- standard play24, 44
- status button17, 19
- status display17
- stereo
 - broadcast
 - receiving39-40
 - recording39-40
 - hookups39
- still/pause button19, 24, 34
- still picture34
- stop button19
- stop/eject button21
- super long play24, 44
- table of contents4
- tape
 - duplication32
 - eject38
 - speed24, 44
- time search36
- time (setting)14-15
- timer
 - light20
 - recording
 - cancelling29
 - correcting30
 - setting26-28
- tracking38
- tv
 - hookups6-10, 32, 39
 - position18, 31, 43
- vcr position18, 20, 31
- vcr/tv button18
- vcr/tv light20
- video in/out jacks
 -10, 21, 22, 32, 39, 44
- warranty46



This owner's manual is made of recyclable materials.
Remember to recycle!

IB8465E002
Printed In China
0VMN04005/ HF3P0UD, HF3P1UD, HF4P0UD * * * * *

Free Manuals Download Website

<http://myh66.com>

<http://usermanuals.us>

<http://www.somanuals.com>

<http://www.4manuals.cc>

<http://www.manual-lib.com>

<http://www.404manual.com>

<http://www.luxmanual.com>

<http://aubethermostatmanual.com>

Golf course search by state

<http://golfingnear.com>

Email search by domain

<http://emailbydomain.com>

Auto manuals search

<http://auto.somanuals.com>

TV manuals search

<http://tv.somanuals.com>