

MAGNAVOX

Smart. Very smart.®

Video Cassette Recorder

VRU344AT

Owner's Manual

IMPORTANT!

Return Your Warranty Registration Card
Within 10 Days. See Why Inside.

MAGNAVOX

Congratulations on your purchase, and welcome to the "family!"

MAGNAVOX
Smart. Very smart.®



Dear MAGNAVOX product owner:

Thank you for your confidence in MAGNAVOX. You've selected one of the best-built, best-backed products available today. And we'll do everything in our power to keep you happy with your purchase for many years to come.

As a member of the MAGNAVOX "family," you're entitled to protection by one of the most comprehensive warranties and outstanding service networks in the industry.

What's more, your purchase guarantees you'll receive all the information and special offers for which you qualify, plus easy access to accessories from our convenient home shopping network.

And most importantly you can count on our uncompromising commitment to your total satisfaction.

All of this is our way of saying welcome—and thanks for investing in a MAGNAVOX product.

Sincerely,

Robert Minkhorst
President and Chief Executive Officer

P.S. Remember, to get the most from your MAGNAVOX product, you must return your Warranty Registration Card within 10 days. So please mail it to us right now!

For Customer Use

Enter below the Serial No. which is located on the rear of the cabinet. Retain this information for future reference.

Model No. _____ Serial No. _____

Know these
safety symbols



This "bolt of lightning" indicates uninsulated material within your unit may cause a electrical shock. For the safety of everyone in your household, please do not remove product covering.

The "exclamation point" calls attention to features for which you should read the enclosed literature closely to prevent operating and maintenance problems.

WARNING: TO PREVENT FIRE OR SHOCK HAZARD, DO NOT EXPOSE EQUIPMENT TO RAIN OR MOISTURE.

CAUTION: To prevent electric shock, match wide blade of plug to wide slot, and fully insert.

ATTENTION: Pour éviter les chocs électriques, introduire la lame la plus large de la fiche dans la borne correspondante de la prise et pousser jusqu'au fond.

Introduction

Features

- HQ (High Quality) System
- Frequency Synthesizer Tuning with Auto Set Feature
- On-Screen Displays in English or Spanish
- Display Panel
- Auto Tracking
- One Touch Recording
- Unattended (Timer) Recording
- Special Effects Playback: Forward and Reverse Searching; Still; Variable Slow; Frame Advance
- Wireless Remote Control with TV and Cable Converter Box Control Possibility
- Repeat Playback
- Auto Operation Features
- Real Time Counter
- Daylight-Saving Time
- VCR Plus+ Function
- Time Search Function
- Skip Search Function
- Jog & Shuttle Control
- Automatic Head Cleaner
- Automatic Clock Setting

Safety Precautions

Warning: To prevent fire or shock hazard, do not expose this equipment to rain or moisture.

FCC Warning: Any unauthorized changes or modifications to this equipment void the user's authority to operate it.

This VCR, equipped with a HQ (High Quality) system, is compatible with existing VHS (video home system) equipment.

Philips Consumer Electronics Company recommends that you use only video cassette tapes that have been tested and inspected for use in two, four, six and eight hour VCRs, and which are labeled with the **VHS** mark. The use of tapes that have not been inspected for use in two, four, six and eight hour VCRs may result in poor picture quality and excessive deposits on the video heads, which may not be covered by the warranty if damage occurs.

Note to the CATV System Installer: This reminder is provided to call the CATV system installer's attention to Article 820-40 of the National Electrical Code, which provides guidelines for proper grounding – in particular, specifying that the cable ground shall be connected to the grounding system of the building, as close to the point of cable entry as possible.

Welcome to your VCR owner's manual. This manual was designed for you. When looking through it, it will help you to keep several things in mind.

One, this manual is divided into four sections. The *Getting Started* section guides you through the initial setup and simple operations of your VCR. The *Operating Your VCR* section shows you all of the controls of the VCR and remote control and explains on-screen displays. The *Doing More* section guides you through the more advanced features of your VCR. Finally, the *Information You May Need* section provides information you may or may not need – other hookups, for example, and trouble checks.

Two, the instructions follow a simple format. Detailed steps explaining operations are on the outside edges of pages. Illustrations accompanied by brief steps explaining operations are on the inside edges of pages. Additional information can be found in boxes labeled NOTES along the lower edges of pages.

Finally, never be afraid to try a feature! **You cannot hurt your VCR by trying any of the features in this manual!**

So read on – and relax.

Before doing anything else, record the VCR's model and serial numbers in the spaces provided on page two. These numbers will help us assist you if you ever call for help.

4

Table of Contents

Getting Started

Introduction	3
Table of Contents	4
Before Using Your VCR	5
Hooking Up Your VCR	6
Turning on Your VCR	7
Playing	8
Recording	9
Setting the Clock	10

Operating Your VCR

On-Screen Displays	12
Display Panel	13
Remote Control Buttons	14
Front Panel	16
Rear Panel	17

Doing More

Recording One Channel/Watching Another	18
One Touch Recording	19
Timer Recording	20
Setting Up VCR Plus+	22
Timer Recording With VCR Plus+	25
Rerecording (Tape Duplication)	26
Channel Memory	27
Language Selection	28
Playback Options	29
Playback Features	32
TV Code Setting	33
Cable Converter Box Code Setting	34

Information You May Need

Specifications/Notes	35
Other Hookups	36
Before Requesting Service	40
Glossary	41
Warranty	42
Index	44
Accessories	44

Before Using Your VCR

Putting Batteries in the Remote Control

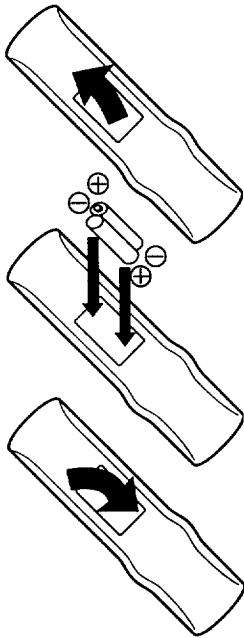

- 1** Remove the battery compartment lid on the bottom of the remote control by pressing in the tab, then lifting the lid.
- 2** Place two AAA batteries inside the battery compartment with their polarities (+ and - ends) aligned as indicated.
- 3** Replace the battery compartment lid.

- The remote control and its batteries are supplied.
- Do not mix alkaline and manganese batteries.
- Do not mix old and new batteries.

Using the Remote Control

Point the remote control at the VCR's remote sensor, making sure to stay within the angle shown.

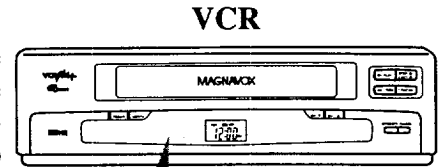

VCR Button

To select channels 100 - 125 using the number buttons, first press the 100 button, then press the last two digits of the desired channel. For example, for channel 117, press the 100 button, 1, 7. **The 100 button will work only when selecting cable channels and when CABLE TV has been selected at the Tuner Setup menu.**

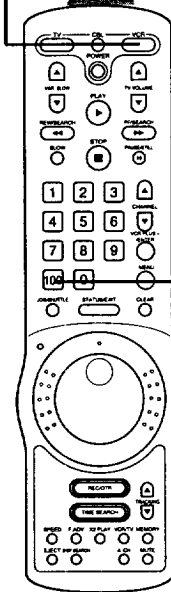

Do not put objects between the remote control and the VCR. To select channels 1 - 9 using the number buttons, first press 0, then press the desired channel number. For example, for channel 6, press 0, 6.

100 Button

Press the VCR button on the remote control before pressing other VCR operation buttons on the remote control.

Remote Control

Erase Protection

Video cassette tapes have record tabs to ensure that recordings are not accidentally erased.

To prevent accidental erasure, break off the tab with a screwdriver.

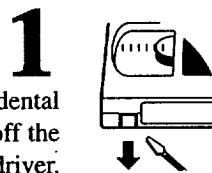

To record again, cover the hole with cellophane tape.

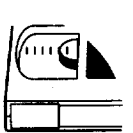

Types of Video Cassette Tapes and Tape Speeds

Tape Speed	Maximum Record/Playback Time			
	Type	T160	T120	T60
SP (Standard Play)		2 hrs. 40 mins.	2 hrs.	1 hr.
LP (Long Play)		5 hrs. 20 mins.	4 hrs.	2 hrs.
SLP (Super Long Play)		8 hrs.	6 hrs.	3 hrs.

- In this VCR, use only tapes with the **VHS** mark.
- The chart at the left shows the recording/playback time for three types of video cassettes (T160, T120, T60). There are three playback speeds: SP, LP, and SLP. During playback, the VCR selects the tape speed automatically. When recording, you can change the speed using the (Tape) **SPEED** button (see page 9).
- Make sure any light adhesive stick-on notes are removed from the video cassette tape before putting it in the VCR. Removable labels like these can jam the VCR.

6

Hooking Up Your VCR

The basic VCR/TV connection – antenna/cable to VCR to TV – is shown below. For other hookups, including those that use cable converter /descrambler boxes, see pages 36 - 39.

1
Disconnect the antenna or cable from your TV.

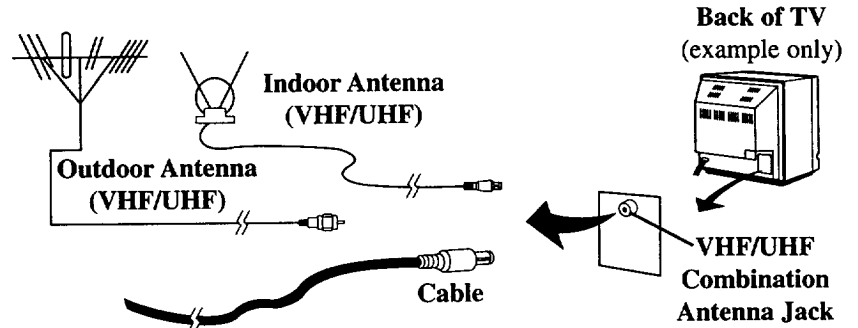

2
Connect the antenna/cable to your VCR.

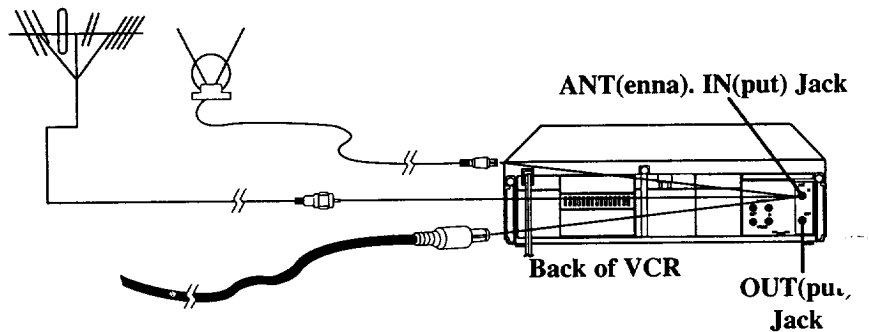

3
Connect your VCR to your TV using the black RF coaxial cable (supplied). Make sure both the TV and the VCR are plugged in.

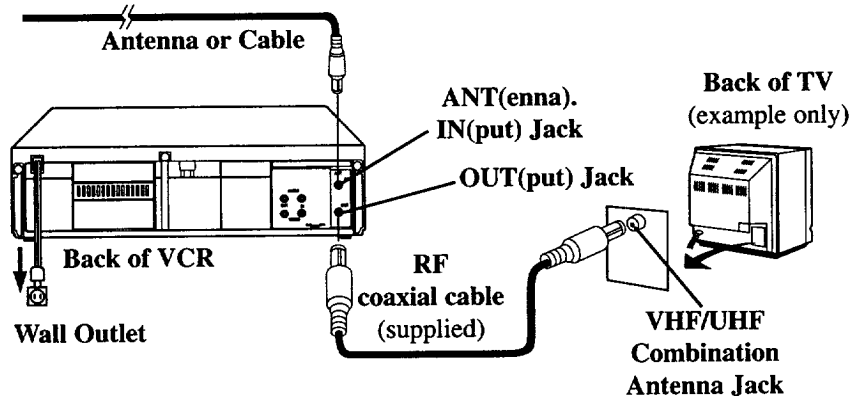

4
Select channel 3 or 4.

Set the CH3/CH4 switch on the back of the VCR to CH3 or CH4, whichever channel is not used or least used in your area. To operate your VCR with your TV, set the TV to the same channel. For example, when playing a tape, if the CH3/CH4 switch is set to CH3, the TV should be on channel 3.

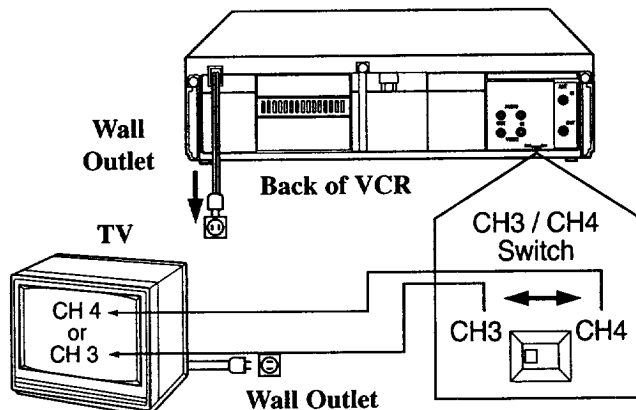

Turning on Your VCR

TV and VCR

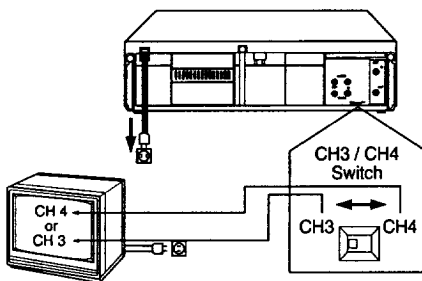

1 Set the TV to channel 3 or 4, whichever channel the CH3/CH4 switch on the back of the VCR is set to.

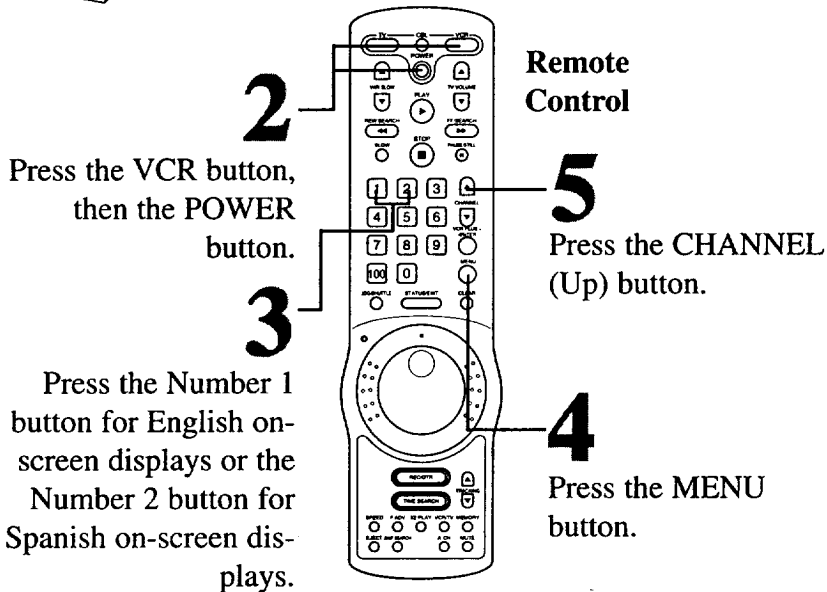

2 Press the VCR button, then the POWER button.

3 Press the Number 1 button for English on-screen displays or the Number 2 button for Spanish on-screen displays.

Remote Control

5 Press the CHANNEL (Up) button.

4 Press the MENU button.

Before turning on your VCR, make sure there are batteries in the remote control and the VCR and TV are connected (see pages five and six).

1

Turn the TV on. Set it to the same channel as the CH3/CH4 switch on the back of the VCR.

2

Press the VCR button, then the POWER button. The VCR will come on and the language select display screen shown below will appear.

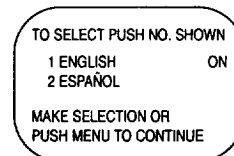

3

Press the Number 1 button to select English on-screen displays or the Number 2 button to select Spanish on-screen displays.

4

Press the MENU button. The channel program display shown below will appear. The display will disappear after about 60 seconds if you do not press any buttons.

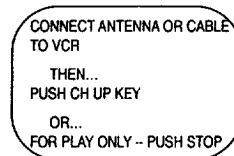

5

Press the CHANNEL (Up) button to begin automatic channel programming. AUTO SET PROCEEDING PLEASE WAIT will appear on-screen. The VCR will place all of the channels you receive into its memory, so when you scan through channels using the CHANNEL (Up/Down) buttons, you'll only scan through channels that you receive. When all channels are programmed, AUTO SET COMPLETED will appear on-screen briefly. Then the TV will go to the lowest channel programmed.

- If you do not see any on-screen displays when you turn on the VCR, repeat the steps under "Hooking Up Your VCR" on page six, then try again. If you still do not see any on-screen displays, follow the steps under "Channel Memory" on page 27 and "Language Selection" on page 28.
- To skip this feature and play a tape immediately, insert a tape with its record tab removed. Playback will start immediately. Or, to skip step 3, press the MENU button. All on-screen displays will be in English. To skip step 5, press the STOP button. Channels will not be programmed, and TUNER NOT SET will appear on-screen.
- To program channels or to change the language at a later time, follow the steps on pages 27 and 28.
- If you try to program channels when there is no antenna or cable connected to the VCR, programming will appear to take place, but eventually NO TV SIGNALS will appear on-screen. Connect an antenna or cable to the VCR and try again. You may need to follow the steps on page 27.
- You cannot program channels if a cable converter box is connected to a VCR that is connected to a TV. If you have this kind of connection, see pages 36-39 for details.
- Follow the steps on this page only when you plug the VCR power cord into the wall outlet for the first time.
- The VCR distinguishes between standard TV channels and cable channels. If you change to TV or CABLE TV mode, follow the steps under "Channel Memory" on page 27.

8

Playing

Read and follow the steps below to play a tape.

1

Turn the TV on and set it to channel 3 or 4, whichever the CH3/CH4 switch on the back of the VCR is set to.

2

Insert a tape in the VCR. The power will come on. The VCR will place itself in VCR position automatically (the VCR light and the Cassette-Inside light on the display panel of the VCR will appear). If the tape's record tab has been removed, playback will start automatically.

3

If playback does not start automatically, press the PLAY button to start playback.

4

Press the STOP button on the remote control or the STOP/EJECT button on the VCR once to stop playback.

5

Press the REW(ind)/SEARCH button on the remote control or the REW(ind) button on the VCR to rewind the tape.

6

Press the EJECT button on the remote control or the STOP/EJECT button on the VCR again to remove the tape.

TV and VCR

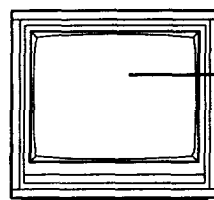

1

Turn the TV on and set it to channel 3 or 4.

2

Insert a tape.

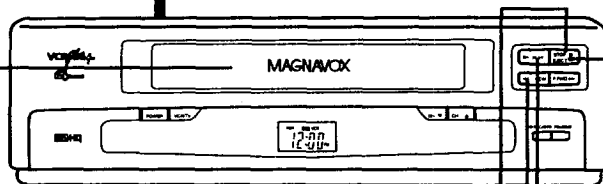

5

Press the REW(ind)/SEARCH button or the REW(ind) button to rewind the tape.

6

Press the EJECT button once or the STOP/EJECT button again to remove the tape.

3

To start playback, press the PLAY button.

4

To stop playback, press the STOP button or the STOP/EJECT button once.

Remote Control

- If the tape you want to play is already in the VCR, make sure the VCR power is on, then press the PLAY button.

Recording

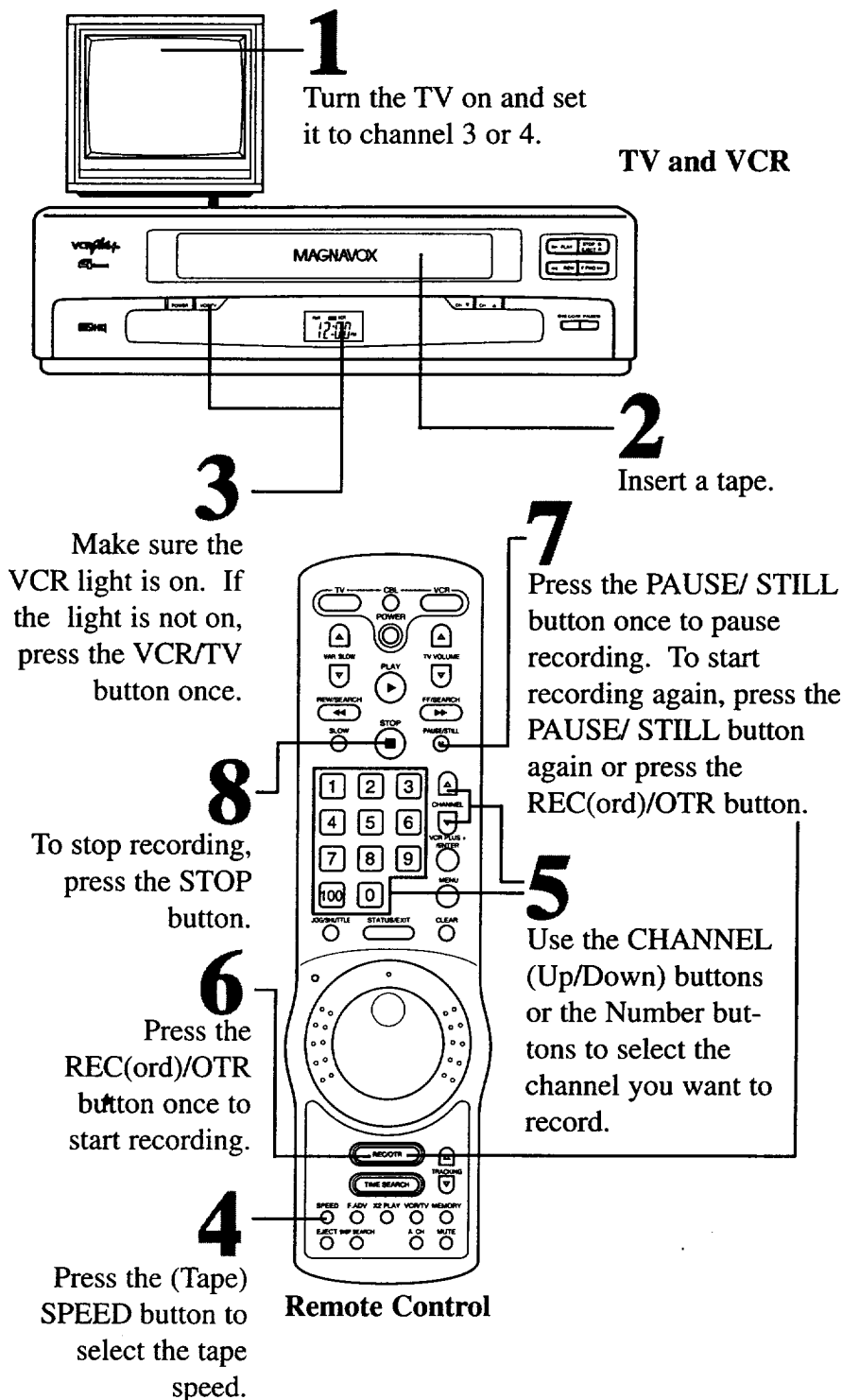

Read and follow the steps below to record a television program.

1

Turn the TV on and set it to channel 3 or 4, whichever the CH3/CH4 switch on the back of the VCR is set to.

2

Insert a tape with its record tab intact (see page five) in the VCR. The power will come on, and the Cassette-Inside light will appear.

3

If the VCR light on the display panel of the VCR appears, go to step 4. If the VCR light does not appear, press the VCR/TV button once.

4

Press the (Tape) SPEED button on the remote control until the desired tape speed (see page five) appears on the TV screen. The tape speed will disappear from the screen after about five seconds.

5

Use the CHANNEL (Up/Down) buttons or the Number buttons to select the channel to be recorded.

6

Press the REC(ord)/OTR button once to start recording. The REC light will appear.

7

To pause the recording (for example, during commercials), press the PAUSE/ STILL button once. The REC light will flash.

To start recording again, press the REC(ord)/OTR button or the PAUSE/ STILL button again. The REC light will appear again.

8

To stop recording, press the STOP button.

- If the REC(ord)/OTR button is pressed while a tape without a record tab is in the VCR, the VCR will eject the tape and PROTECTED CASSETTE CANNOT RECORD will flash on-screen.
- Other recording options are on pages 18 - 26.
- You can change the tape speed while the VCR is recording, but some distortion will appear on the tape.

Setting the Clock

There are two ways to set the clock. With **manual clock setting**, you tell the VCR the current time. The VCR then adjusts the time accordingly. With **automatic clock setting**, the VCR gets the current time from your local PBS station. It keeps track of the time by constantly referring to the time broadcasted by your PBS station.

Follow the instructions under either **manual clock setting** or **automatic clock setting** (page 11) to set the VCR's clock.

Make sure:

- The VCR is hooked up and turned on, and channels are programmed into the VCR's memory.
- The VCR is in VCR position (see pages 13, 15-16).
- You make each entry within 60 seconds of the previous entry (otherwise, the VCR will exit Clock Set mode and you will have to start over).
- You have correctly chosen TV or CABLE TV at the TUNER SET UP menu.

Manual Clock Setting

1

Press the MENU button to bring up the main menu display.

TO SELECT PUSH NO. SHOWN
1 PROGRAM
2 VCR SET UP
3 TUNER SET UP
4 SET CLOCK

TO END PUSH EXIT

2

Press the Number 4 button to select SET CLOCK.

SET CLOCK
1 AUTO CLOCK [OFF]
2 SET MANUAL CLOCK
3 DAYLIGHT SVG TIME [OFF]
CABLE BOX USERS
SET CLOCK MANUALLY

TO SELECT PUSH NO. SHOWN
TO END PUSH EXIT

3

If ON appears to the right of AUTO CLOCK, press the Number 1 button. OFF will appear to the right of AUTO CLOCK.

4

Press the Number 2 button to select SET MANUAL CLOCK.

TIME ---
DATE ---/---/---

TO END PUSH EXIT

5

Press two Number buttons for the hour(s) and two Number buttons for the minute(s). Then press 1 for AM or 2 for PM. For example, for 2:15 PM, press 02, 15, 2.

- Enter a 0 before a single digit number.
- Entries that do not match the VCR's internal calendar will cause a question mark (?) to appear on-screen.
- To make corrections, press the CLEAR button until the space for the number you want to correct is flashing. Then enter the correct number.

TIME 02:15 PM
MONTH ---/---

TO CORRECT PUSH CLEAR
TO END PUSH EXIT

6

Press two Number buttons for the month, two Number buttons for the day, and two Number buttons for the year. For example, for July 1, 1996, press 07, 01, 96. The day of the week will appear automatically.

TIME 02:15 PM
DATE 07 / 01 / 96
MON.

TO CORRECT PUSH CLEAR
TO END PUSH EXIT

7

Press the STATUS/EXIT button to start the clock. The screen will return to the program you were watching.

Daylight-Saving Time Selection

Follow the steps below to program the VCR so its clock will automatically move forward one hour in April and turn back one hour in October.

1

Press the MENU button to bring up the main menu display.

TO SELECT PUSH NO. SHOWN
1 PROGRAM
2 VCR SET UP
3 TUNER SET UP
4 SET CLOCK

TO END PUSH EXIT

2

Press the Number 4 button to select SET CLOCK.

SET CLOCK
1 AUTO CLOCK [OFF]
2 SET MANUAL CLOCK
3 DAYLIGHT SVG TIME [OFF]
CABLE BOX USERS
SET CLOCK MANUALLY

TO SELECT PUSH NO. SHOWN
TO END PUSH EXIT

3

Press the Number 3 button so that ON appears to the right of DAYLIGHT SVG TIME.

SET CLOCK
1 AUTO CLOCK [OFF]
2 SET MANUAL CLOCK
3 DAYLIGHT SVG TIME [ON]
CABLE BOX USERS
SET CLOCK MANUALLY

TO SELECT PUSH NO. SHOWN
TO END PUSH EXIT

4

Press the STATUS/EXIT button to exit.

Setting the Clock (cont'd)

Automatic Clock Setting

1

Press the MENU button to bring up the main menu display.

2

Press the Number 4 button to select SET CLOCK.

3

If OFF appears to the right of AUTO CLOCK, press the Number 1 button once. A new display screen will appear. If ON appears to the right of AUTO CLOCK, press the Number 1 button twice. A new display screen will appear.

4

- If you want the VCR to locate a local PBS station from which to take the time, press the Number 1 button to select SET PBS CH. AUTO. If the current time appears on-screen, you're finished. Press the STATUS/EXIT button to exit.
NOTE: CANNOT FIND PBS CLOCK DATA may flash on-screen. In this case, tell the VCR the PBS station from which to take the time.
- If you want to tell the VCR the PBS station from which to take the time, press the Number 2 button to select SET PBS CH. MANUAL, then use the Number buttons to select the channel number of the desired PBS station. If the current time appears on-screen, you're finished. Press the STATUS/EXIT button to exit.
NOTE: CANNOT FIND PBS CLOCK DATA may flash on-screen. In this case, press the Number 1 button to choose SELECT NEW PBS CH., then use the Number buttons to select the channel number of another PBS station. Or, press the Number 2 button to select SET PBS CH. AUTO, then go to step 5.

5

Turn the VCR power off, and leave it off for several minutes. When you can

Remote Control

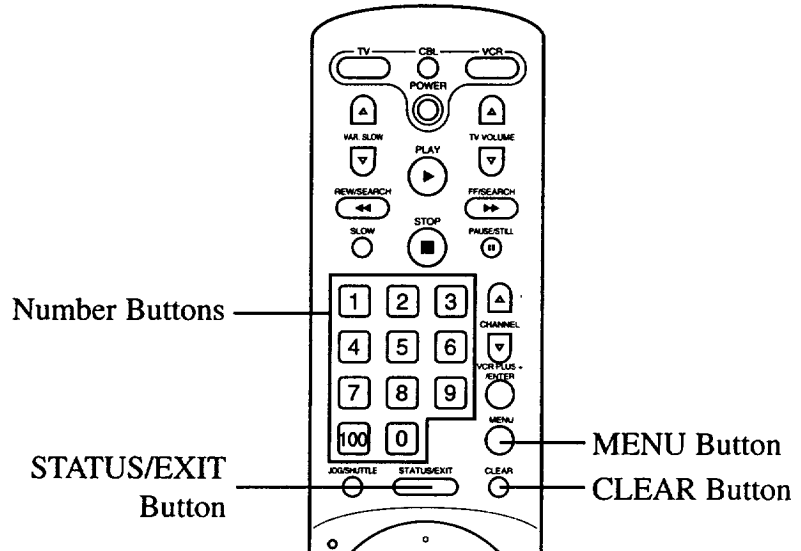

- To reset the clock, follow the steps on page 10 or page 11.
- To display the time, press the STATUS/EXIT button. A status display, which includes the time, will appear on the TV screen for about five seconds. For details, see "On-Screen Displays" on page 12.
- If you press the STATUS/EXIT button while you are setting the clock, the TV screen will return to the program you were watching. If this happens, start over.
- To cancel the Daylight-Saving Time, follow steps 1 - 2 under "Daylight-Saving Time Selection" on page 10. At step 3, press the Number 3 button so that OFF appears to the right of DAYLIGHT SVG TIME. Press the STATUS/EXIT button to exit.

For Manual Clock Setting

- To make corrections while you are setting the clock manually, press the CLEAR button until the space for the number you want to correct is flashing. Then enter the correct number.
- If the numbers entered do not match the VCR's internal calendar, the entry will be rejected and a question mark (?) will appear on the TV screen.
- Power failures that last for more than one minute can cause you to lose your clock setting when you use the VCR with the auto clock function set to OFF. If this happens, follow the steps on page 10.

For Automatic Clock Setting

- If TV has been selected at the TUNER SET UP menu, you can select channels 2 - 69 at step 4 under "Automatic Clock Setting." If CABLE TV has been selected from the TUNER SET UP menu, you can select channels 1 - 125 at step 4 under "Automatic Clock Setting." See page 27 for details.
- If you select SET PBS CH. AUTO at the AUTO CLOCK menu, you cannot manually select the PBS channel from which you want the VCR to take the time.
- If the clock still is not set when you turn the VCR back on at step 5 under "Automatic Clock Setting," set the clock manually.
- The clock cannot be set automatically if you don't receive a channel that carries a time signal in your area. If this is the case, set the clock manually.
- If there are only a few channels in your area that carry time signals, setting the clock automatically may take several minutes. If nothing happens even after you wait several minutes, set the clock manually.

On-Screen Displays

VCR Status Display

A status display, which includes the current time, channel, and other information (see illustration of the status display at right), will appear when you press the STATUS/EXIT button or certain function buttons.

The contents of the status display may vary.

ON SCREEN ON:

- Whenever you press the STOP button or the PLAY button, the status display will appear for five seconds.

COUNTER ONLY:

- Whenever you press the STOP button or the PLAY button, the status display will appear for five seconds. After five seconds, only the counter will remain on-screen. You must press the STATUS/EXIT button to remove it.

ON SCREEN OFF:

- The status display will not appear when you press function buttons.
- You must press the STATUS/EXIT button to see the status display.

To choose the status display mode:

1

Press the MENU button to bring up the main menu display.

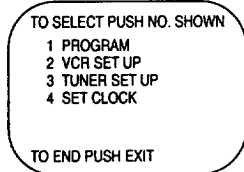

2

Press the Number 2 button to select VCR SET UP.

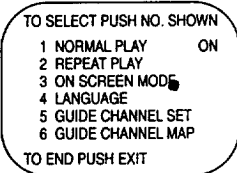

3

Press the Number 3 button to select ON SCREEN MODE.

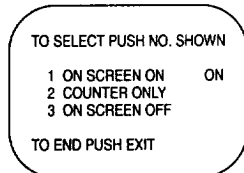

4

Press the Number 1 button to select ON SCREEN ON, the Number 2 button to select COUNTER ONLY, or the Number 3 button to select ON SCREEN OFF. ON will appear beside the selected status display mode.

5

Press the STATUS/EXIT button to exit

VCR Status Display Screen

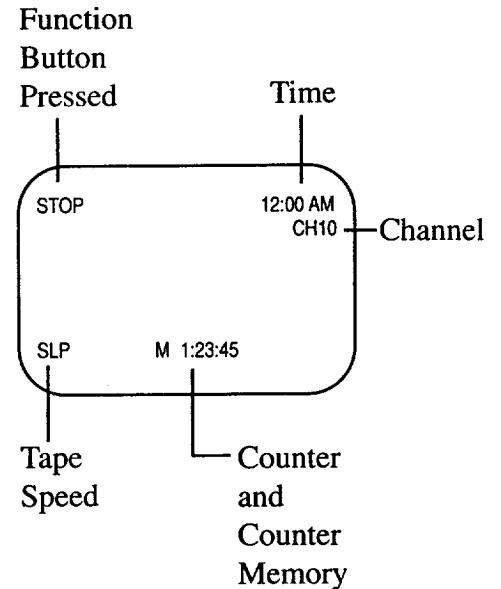

- If the channel you select has no broadcast, the screen will become a solid blue field. The screen will remain blue until you select an active channel.
- You may bring up the status display at any time by pressing the STATUS/EXIT button.
(The exception is when viewing a still picture or a slow motion picture, or when FF/SEARCH or REW(ind)/SEARCH is pressed during playback.)
- Channel numbers (when tuned) are displayed for a few seconds.

13 Display Panel

VCR Display Panel
Information about VCR operations is displayed here.

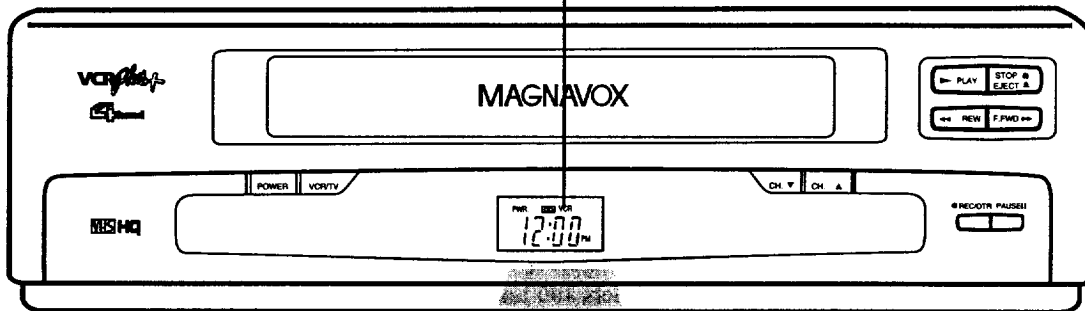

Timer Light
This light glows when a timer recording or a one touch recording has been set. It flashes when the power is off if a timer recording has been set but a tape has not been placed in the VCR. It also flashes when a timer recording has finished (unless another timer recording is programmed, in which case it glows).

Cassette-Inside Light
This light appears when there is a tape in the VCR.

VCR Light
This light appears when the VCR is in VCR position.

PWR(power). Light
This light indicates that the power is turned on.

REC(ord) Light
This light indicates that a recording is in progress. It flashes when a recording has been paused.

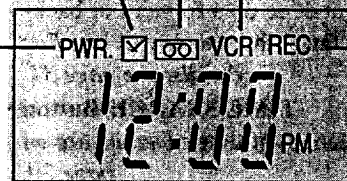

Clock/Feature Display
This display tells you the current time (when the clock is set), and briefly displays which feature the VCR is currently performing.

PLAY	: Playback
FF	: Fast forward
REW	: Rewind
STOP	: Stop
REC	: Recording

Remote Control Buttons

TV Button
Press to operate the TV.
Details are on page 33.

CBL Button
Press to operate the cable converter box.
Details are on page 34.

POWER Button
Press to turn the TV, VCR or cable converter box on or off.

SLOW and VAR(iable). SLOW Buttons
Press the SLOW button to view the picture in slow motion. Press again to return to normal playback. Then vary the speed from 1/6 to 1/30 of normal speed using the VAR(iable). SLOW buttons. *Details are on page 31.*

REW(ind)/SEARCH Button
When in Stop mode, press to rewind the tape at high speed. When in Play mode, press to rewind the tape while the picture stays on-screen.

Number Buttons
Use to select channels and on-screen menus, and to program VCR functions (such as setting the clock).

Channels 1 - 9 ●
To select, press 0, then the channel you want. For example, to select channel 7, press 0, 7.

Channels 100 and above ●
To select, press the 100 button, then press the last two digits of the channel you want. For example, to select channel 117, press the 100 button, 1, 7.

JOG/SHUTTLE Button
Press to use the Jog Dial or the Shuttle Ring. *For details, see page 31.*

Jog/Shuttle Light
Lights up when the JOG/SHUTTLE button is pressed.

Jog Dial
When you turn this dial in either direction while in the Play or Still mode, the tape moves forward or backward frame-by-frame at a speed that corresponds to the speed at which the dial is turned. *For details, see page 31.*

Shuttle Ring
Turn and hold this ring while in the Play or Still mode to do a forward or backward search. The more the ring is rotated, the faster the search will be. *For details, see page 31.*

TIME SEARCH Button
Press to fast forward or rewind the tape a specific length of time. *Details are on page 29.*

(Tape) SPEED Button
Press to select the recording speed (SP, LP or SLP).

EJECT Button
Press to eject the tape.

F(rame). ADV(ance) Button
Press when in Still mode to advance the picture one frame at a time. *Details are on page 31.*

SKIP SEARCH Button
Press during tape playback to skip forward 30 seconds at a time.

X2 PLAY Button
When in Play mode, press to watch a tape at two times the normal playback speed. *Details are on page 31.*

NOTES

Shaded boxes indicate TV and cable converter box control buttons. They may or may not operate your TV or cable converter box. See pages 33-34 for details.

- Press the VCR button on the remote control before pressing other VCR operation buttons on the remote control.
- Press the TV button on the remote control before pressing other TV operation buttons on the remote control.
- Press the CBL button on the remote control before pressing other cable converter box operation buttons on the remote control.

Remote Control Buttons (cont'd)

STOP Button

Press to stop the tape.

VCR Button
Press to operate the VCR.

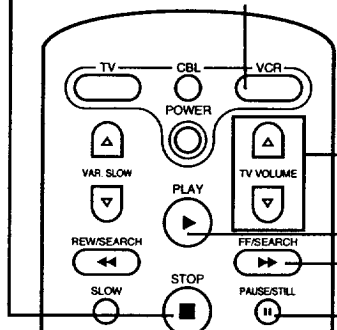

TRACKING (Up/Down) Buttons
Press to increase or decrease the TV's volume.

PLAY Button

Press to play a tape. Also, press to release Search, Slow or Still mode and to return to normal playback (see page 31 for details).

FF/SEARCH Button

When in Stop mode, press to fast forward the tape at high speed. When in Play mode, press to fast forward while the picture stays on-screen.

PAUSE/STILL Button

In Record mode, press to temporarily stop the recording (pause). You can not pause a one touch recording that is set for a specific length of time. In Play mode, press to freeze the picture (still). Press a second time to resume normal recording or playback. Details are on pages nine and 31.

CHANNEL (Up/Down) Buttons
Press to scan through the TV, cable converter box or VCR's channels after the channels have been programmed. Details are on page 27.

VCR PLUS+/ENTER Button

Press to set a Timer Recording with VCR Plus+. Details are on pages 22-25.

MENU Button

Press to bring up the main menu display. Or, if you have a Magnavox TV, press when in TV position to display the Magnavox TV menu.

CLEAR Button

Press to erase incorrect data when programming VCR functions. Also, press to reset the time counter (0:00:00 will appear on-screen).

STATUS/EXIT Button

Press to see the status display or to make status displays disappear. Details are on page 12. Press to exit on-screen menus.

REC(ord)/OTR Button

Press once to start a recording (see page nine for details). Or, press three to 10 times to start a one touch recording (an immediate timed recording, 30 minutes to four hours long) of the channel you are watching (see page 19 for details).

TRACKING (Up/Down) Buttons

When in Play or Slow mode, press to adjust the tracking. Details are on page 32.

MEMORY Button

Press to memorize a tape position at which the time counter was set to 0:00:00. Details are on page 30.

SOUND Buttons
Press to mute the TV's sound. Press again to return to the previous volume level.

VCR/TV Button

Use to select the signal that your TV receives.

- **VCR Position**

Use to watch a tape, to watch a program while recording it, or to watch a TV broadcast using the CHANNEL (Up/Down) or Number buttons.

- **TV Position**

Use to watch TV or to watch one program while recording another. Detail are on page 18.



NOTES

Shaded boxes indicate TV and cable converter box control buttons. They may or may not operate your TV or cable converter box. See pages 33-34 for details.

- Press the VCR button on the remote control before pressing other VCR operation buttons on the remote control.
- Press the TV button on the remote control before pressing other TV operation buttons on the remote control.
- Press the CBL button on the remote control before pressing other cable converter box operation buttons on the remote control.

Front Panel

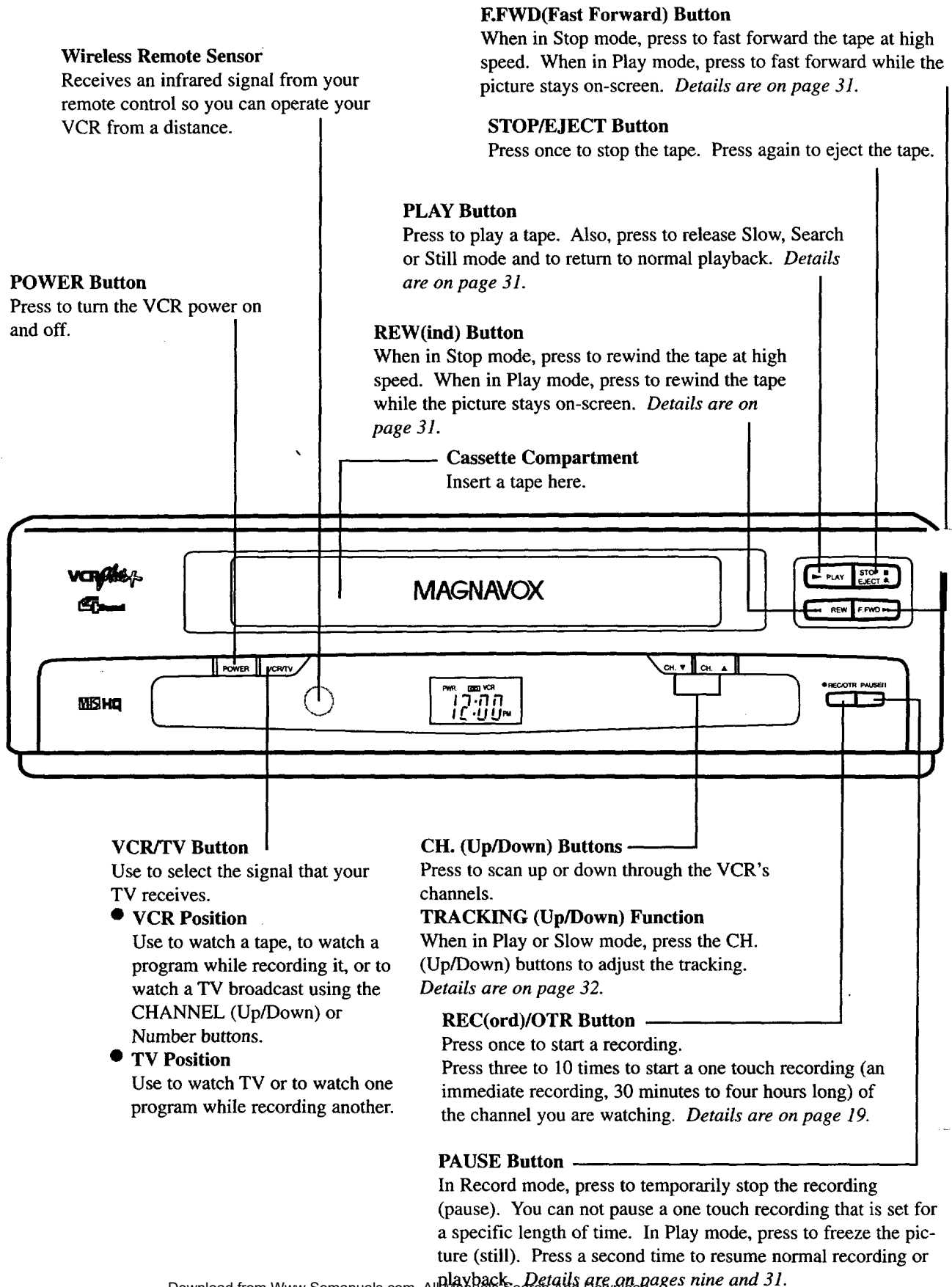

Wireless Remote Sensor

Receives an infrared signal from your remote control so you can operate your VCR from a distance.

POWER Button

Press to turn the VCR power on and off.

PLAY Button

Press to play a tape. Also, press to release Slow, Search or Still mode and to return to normal playback. *Details are on page 31.*

REW(ind) Button

When in Stop mode, press to rewind the tape at high speed. When in Play mode, press to rewind the tape while the picture stays on-screen. *Details are on page 31.*

Cassette Compartment

Insert a tape here.

F.FWD(Fast Forward) Button

When in Stop mode, press to fast forward the tape at high speed. When in Play mode, press to fast forward while the picture stays on-screen. *Details are on page 31.*

STOP/EJECT Button

Press once to stop the tape. Press again to eject the tape.

VCR/TV Button

Use to select the signal that your TV receives.

● VCR Position

Use to watch a tape, to watch a program while recording it, or to watch a TV broadcast using the CHANNEL (Up/Down) or Number buttons.

● TV Position

Use to watch TV or to watch one program while recording another.

CH. (Up/Down) Buttons

Press to scan up or down through the VCR's channels.

TRACKING (Up/Down) Function

When in Play or Slow mode, press the CH. (Up/Down) buttons to adjust the tracking. *Details are on page 32.*

REC(ord)/OTR Button

Press once to start a recording.

Press three to 10 times to start a one touch recording (an immediate recording, 30 minutes to four hours long) of the channel you are watching. *Details are on page 19.*

PAUSE Button

In Record mode, press to temporarily stop the recording (pause). You can not pause a one touch recording that is set for a specific length of time. In Play mode, press to freeze the picture (still). Press a second time to resume normal recording or playback. *Details are on pages nine and 31.*

Rear Panel

ANT(enna). IN(put) Jack
 Connect your antenna or cable here. *Details are on page six.*

AUDIO IN(put) Jack
 Connect a cable coming from the audio output jack of a camcorder, another VCR, or an audio source here. *Details are on page 26.*

AUDIO OUT(put) Jack
 Connect a cable coming from the audio input jack of a camcorder, another VCR, or an audio source here. *Details are on page 26.*

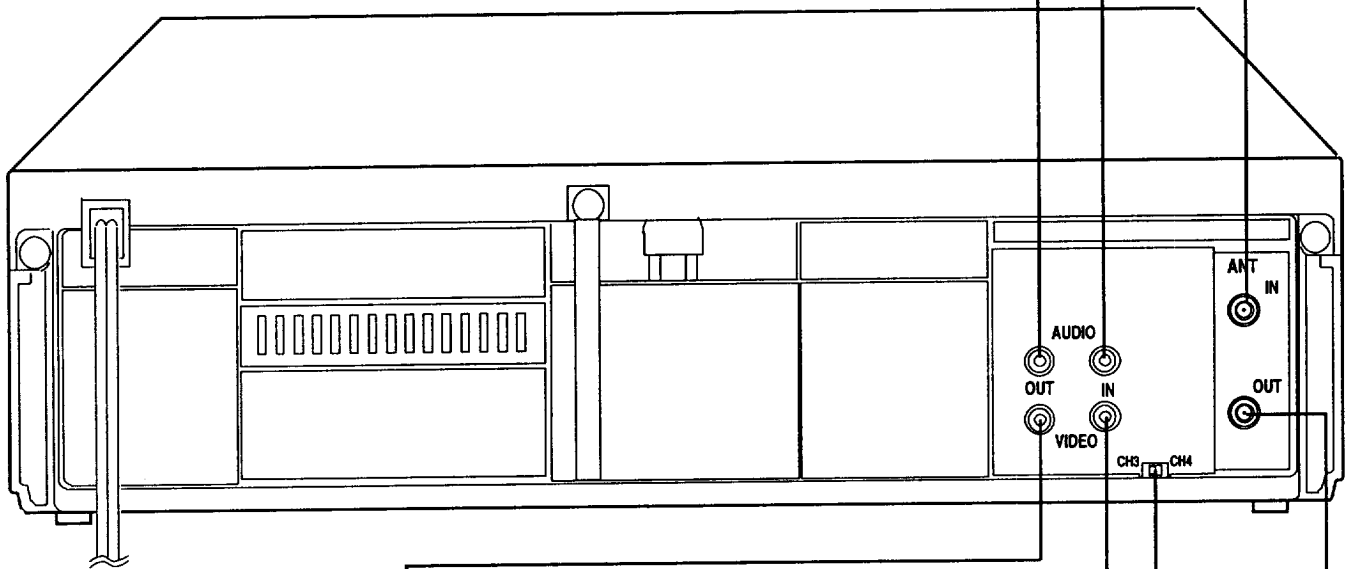

VIDEO OUT(put) Jack
 Connect a cable coming from the video input jack of a camcorder, another VCR, or an audio-visual source (laser disc, video disc player, etc.) here. *Details are on page 26.*

VIDEO IN(put) Jack
 Connect a cable coming from the video output jack of a camcorder, another VCR, or an audio-visual source (laser disc, video disc player, etc.) here. *Details are on page 26.*

AC Power Cord
 Connect to a standard AC outlet to supply power to the VCR.

CH3/CH4 Switch
 Set to channel 3 or 4 to use your TV with your VCR. *Details are on page six.*

OUT(put) Jack
 Use the supplied RF coaxial cable to connect this jack to the VHF/UHF jack on your TV. *Details are on page six.*

Recording One Channel/Watching Another

1

Start a recording (see page nine).

2

Press the VCR/TV button to put the VCR in TV position. The VCR light will disappear from the VCR's display panel.

3

Use the TV controls to select the channel you want to watch.

4

To return to the channel being recorded, use the TV controls to select channel 3 or 4 (see page six for details). Press the VCR/TV button to put the VCR in VCR position. The channel being recorded will appear on-screen.

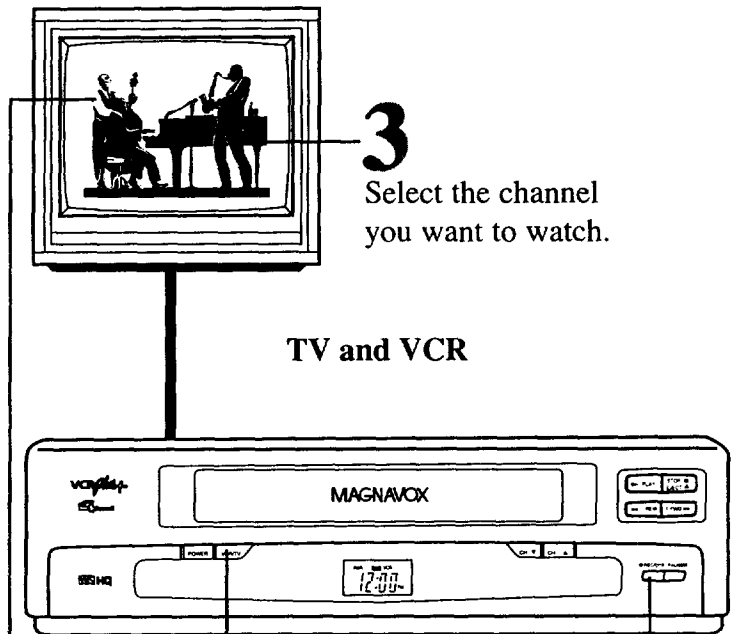

TV and VCR

4

To return to the channel being recorded, set the TV to channel 3 or 4. Then, press the VCR/TV button to put the VCR in VCR position.

2

Press the VCR/TV button to put the VCR in TV position.

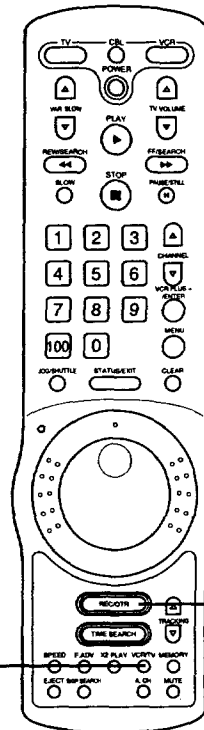

Remote Control

1

Start a recording.

- If you use a cable converter box or satellite system hookup, you may not be able to watch one channel while recording another. See pages 35, 38-39 for details.
- If you don't receive channels, please repeat the steps on page six, then follow the instructions above carefully.

One Touch Recording

Remote Control

1 Use the CHANNEL (Up/Down) buttons or the Number buttons to select the channel you want to record.

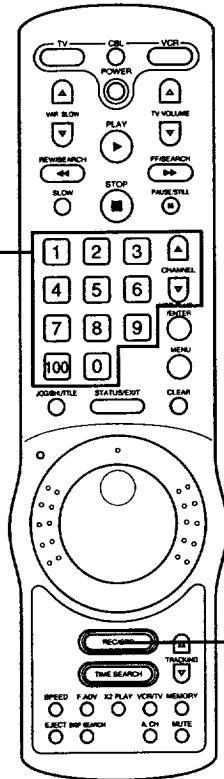

2 Press the REC(ord)/OTR button repeatedly until the desired recording length appears in the upper left corner of the screen.

The one touch recording (OTR) function allows you to program an immediate timed recording 30 minutes to four hours long without setting the timer. Before you begin, make sure:

- Channels have been programmed.
- The desired recording speed (SP, LP, SLP) has been selected with the (Tape) SPEED button.
- There is a tape in the VCR. Make sure the tape's record tab is intact and the tape is long enough to record the program(s).
- The VCR is in VCR position.

Starting an OTR

1 Use the CHANNEL (Up/Down) buttons or the Number buttons to select the channel you want to record.

2 Press the REC(ord)/OTR button repeatedly until the desired recording length (30 minutes to four hours) appears in the upper left corner of the screen. Recording will begin immediately.

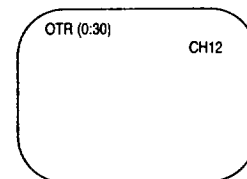

Stopping an OTR

To stop an OTR before recording is finished, press the STOP button or the POWER button. To cancel the OTR but continue recording, press the REC(ord)/OTR button until REC appears in the upper left corner of the screen.

- To check the time remaining for an OTR after the OTR has been set, press the STATUS/EXIT button.
- To change the recording length while an OTR is in progress, press the REC(ord)/OTR button until the desired length appears on-screen.
- If you begin an OTR when a recording is paused, the OTR will begin.
- You can not pause recording (for example, during commercials) during an OTR.
- If the preset time for a time recording comes up during an OTR, the OTR has priority.

Timer Recording

Follow the steps below to program your VCR to record TV programs while you're away from home. You can program up to eight timer recordings. For each one, the VCR will turn itself on, record, and turn itself off automatically. Before you begin make sure:

- Channels have been programmed.
- The clock has been set.
- There is a tape in the VCR. Make sure the tape's record tab is intact and the tape is long enough to record the program(s).
- The VCR is in VCR position.

You must do each step within 60 seconds of completing the previous step. If you don't, you will have to start again at step 1.

1

Press the MENU button to bring up the main menu display.

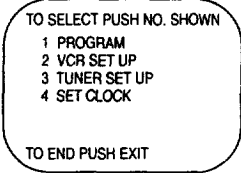

2

Press the Number 1 button on the remote control to select PROGRAM.

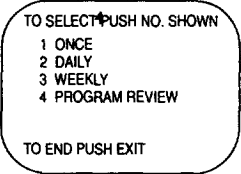

3

Select a once, daily or weekly recording.

- Press the Number 1 button to select ONCE. The VCR will record a TV program on any day you choose, up to 12 months away.
- Press the Number 2 button to select DAILY. The VCR will record from Monday to Friday – starting at the same time and for the same length of time.
- Press the Number 3 button to select WEEKLY. The VCR will record on the same day, at the same time, and for the same length of time every week.

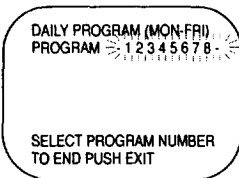

Daily Recording Menu Screen

4

Use the Number buttons (1 - 8) to select a position in which to store the timer recording. Flashing numbers indicate an open position (one in which a timer recording has not yet been stored).

NOTE: If you select a number that has already been used to store a timer recording, PREVIOUSLY SET PROGRAM will appear on-screen for a few seconds. Then information about the program in that position will be displayed on-screen. If this happens, press the STATUS/EXIT button twice. Then start again at step 1.

5

- If you are using a standard antenna to VCR to TV hookup, enter the channel of the TV program you want to record (you must enter a 0 before all single digit channels).
- If you are recording from line input, press 0, 0. A/V IN will appear on-screen.
- If you are recording using a cable converter box (channel 3 or 4), see pages 38 - 39.

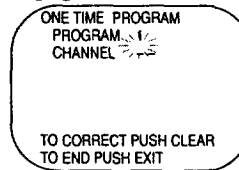

6

Press two Number buttons for the hour(s) you want the recording to begin. Press two number buttons for the minute(s) you want the recording to begin. Press 1 for AM or 2 for PM. For example, for 9:30 PM, press 09, 30, 2.

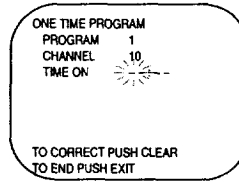

7

Follow the instructions in step 6 to set the recording's stop time (AM or PM will be set automatically).

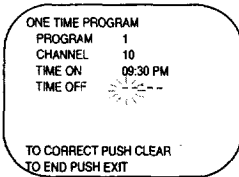

Checking or Clearing Timer Recordings

1. With the VCR on and in VCR position, press the MENU button.
2. Press the Number 1 button to select PROGRAM.
3. Press the Number 4 button to select PROGRAM REVIEW. The timer recording information for the position will appear on-screen. If there are no timer recordings set, nothing will happen when you press the Number 4 button.
4. Press the Number 1 button repeatedly to review all programmed timer recordings. If you don't press the Number 1 button in 10 seconds, the

- VCR will automatically display information about the next programmed timer recording. This will continue until all filled positions have been displayed. Then the menu will disappear.
5. To cancel the timer recording displayed, press the CLEAR button.
6. Repeat steps 1 - 5 to make sure you have cleared the correct timer recording.

Timer Recording (cont'd)

8

Press the Number 1 button to record in SP speed, press the Number 2 button to record in LP speed, or press the Number 3 button to record in SLP speed. For details, see page five. You cannot use the (Tape) SPEED button at this time.

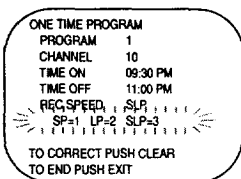

9

Press two Number buttons for the month and the day you want to record the program. For example, for July 10, 1996, press 07, 10. The day of the week and the year will be displayed automatically (you cannot program the VCR to record more than one year in advance).

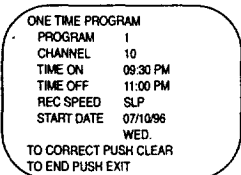

10

Press the STATUS/EXIT button. PROGRAM WAS COMPLETED PLEASE TURN OFF VCR FOR TIMER RECORDING will appear on-screen (if PROGRAM NOT COMPLETED appears, try again from step 1). In three seconds the on-screen display will disappear. Now, go to steps 11 and 12.

Making Corrections

1. While the screen you want to change is displayed, press the CLEAR button until the cursor is flashing on the item you want to change. Then enter the correct information.
2. Continue to do this until all information is correct.
3. Press the STATUS/EXIT button to exit.

11

If you want to program another timer recording, press the MENU button. Repeat steps 2 - 10. If you don't want to program another timer recording, go to step 12.

12

Turn off the VCR power. The Timer light will appear. The VCR must be turned off for a timer recording to take place. If you forget to turn the VCR off, PLEASE TURN OFF VCR FOR TIMER RECORDING flashes on your TV screen two minutes before a timer recording starts. You can remove it by pressing the CLEAR button.

**The VCR
must be off for a
timer recording
to take place!
Make sure there
is a tape in the
VCR.**

Note: You can exit the Program review at any time by pressing the STATUS/EXIT button.

VCR

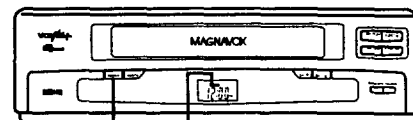

POWER Button

Timer Light

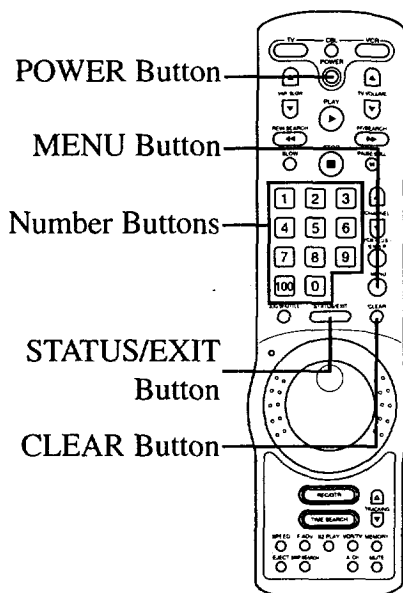

POWER Button

MENU Button

Number Buttons

STATUS/EXIT Button

CLEAR Button

Remote Control

- CLASH may flash on the screen when you finish setting a timer recording. This means that the timer recording you just programmed and another timer recording overlap, and thus the current timer recording will not be carried out. In this case, cancel one of the overlapping timer recordings.
- If the preset time for a timer recording comes up during an OTR, the OTR has priority.
- To stop a started timer recording, press the STOP/EJECT button on the VCR.
- If the power fails for more than one minute, programmed timer recordings will be lost. When you use the VCR with the auto clock function set to OFF, repeat the steps on page 10 before re-programming the timer recordings.

Please see page 35 for more notes.

Setting Up VCR Plus+ (cont'd)

2

Now, compare the channel numbers you have written in the GUIDE CH. and USER CH. columns. You'll notice that some stations have guide and user channel numbers that are the same, and other stations have channel numbers that do not match. Where the channel numbers DO NOT match, you must tell the VCR the guide and user channel numbers according to the following steps.

- Make each entry within 60 seconds of the previous entry.



3

Press the MENU button, then press the Number 2 button to select VCR SET UP.

TO SELECT PUSH NO. SHOWN
 1 NORMAL PLAY ON
 2 REPEAT PLAY
 3 ON SCREEN MODE
 4 LANGUAGE
 5 GUIDE CHANNEL SET
 6 GUIDE CHANNEL MAP
 TO END PUSH EXIT

4

Press the Number 5 button to select GUIDE CHANNEL SET.

GUIDE CHANNEL SET
 SELECT GUIDE CH. NO.
 GUIDE CH. 
 USER CH. 

TO END PUSH EXIT

5

Look at the boxes you filled in on pages 22-23. For stations whose guide channels and user channels are not the same, press two Number buttons for the guide channel and two Number buttons for the user channel.

- Always enter a "0" before single digit channels.
- To select line input for the user channel, press 0, 0. AUX will appear on-screen.

GUIDE CHANNEL SET
 SELECT USER CH. NO.
 GUIDE CH. 28
 USER CH. 

TO CORRECT PUSH CLEAR
 TO END PUSH EXIT

6

Press the Number 1 button so your VCR will memorize the guide channel and user channel numbers you have selected. Or, press the Number 2 button to quit and select another pair of numbers.

GUIDE CHANNEL SET
 TO SELECT PUSH NUMBER
 GUIDE CH. 28
 USER CH. 04
 1 MEMORIZE
 2 SELECT ANOTHER CH.
 TO CORRECT PUSH CLEAR
 TO END PUSH EXIT

7

Repeat steps 5 and 6 for all the stations on your list which have different guide channel and user channel numbers.

8

Press the STATUS/EXIT button to exit.

9

To confirm the guide channel and user channel numbers you have selected, press the MENU button to bring up the main menu display. Then press the Number 2 button to select VCR SET UP. Finally, press the Number 6 button to select GUIDE CHANNEL MAP. A list of guide channel and user channel numbers memorized by the VCR will appear on-screen. If there are more than 10 pairs of numbers, press the Number 1 button to view another screen of numbers. Make sure these numbers correspond to the boxes you filled in in step 1. Then press the STATUS/EXIT button to exit.

GUIDE CHANNEL MAP
 GUIDE : USER GUIDE : USER
 1 : AUX 2 : 2
 3 : 3 4 : 4
 6 : 6 7 : 7
 9 : 9 10 : 10
 23 : 5 91 : 8
 TO CANCEL PUSH CLEAR
 NEXT=1 END=EXIT

Remote Control

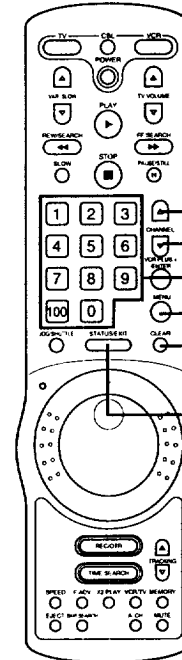

- CHANNEL (Up/Down) Buttons
- Number Buttons
- MENU Button
- CLEAR Button
- STATUS/EXIT Button

- **To correct a guide channel number:**
 1. Repeat steps 3 – 4 on this page.
 2. At step 5, enter the incorrect guide channel number for both the guide channel and the user channel. Press the Number 1 button. Press the STATUS/EXIT button to exit.
 3. Repeat steps 3 – 6 again, this time entering the correct guide channel and user channel. Press the STATUS/EXIT button to exit.
- **To correct a user channel number:**
 1. Repeat steps 3 – 4 on this page.
 2. At step 5, enter the correct guide channel and user channel numbers. Press the Number 1 button. Press the STATUS/EXIT button to exit.
- **To cancel a pair of numbers:**
 1. Follow step 9 to display the guide channel map.
 2. Press the CLEAR button. A pair of numbers will flash.
 3. Press the CHANNEL (Up/Down) buttons until the pair of numbers you wish to cancel is flashing.
 4. Press the CLEAR button again. The pair of numbers that was flashing will disappear.
 5. Press the STATUS/EXIT button to exit.

Timer Recording With VCR Plus+

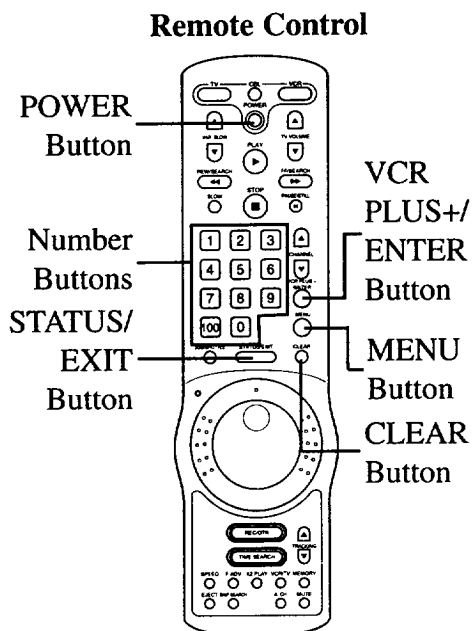

- If you make a mistake while you are entering the VCR Plus+ number of a program, press the CLEAR button until the cursor is flashing on the item you want to correct. Then enter the correct number.
 - If CODE ERROR flashes after you enter the VCR Plus+ number and press the VCR PLUS+/ENTER button, the number you entered was incorrect (for example, too short). If this happens, enter the correct number.
 - CLASH may flash on the screen at step 2. This means that the timer recording you just programmed and another timer recording overlap, and thus the current timer recording will not be carried out.
 - To quit VCR Plus+ programming at any time, press the STATUS/EXIT button. The display will disappear from the TV screen.
 - If the preset time for a timer recording comes up during an OTR, the OTR has priority.
 - To stop a started timer recording, press the STOP/EJECT button on the VCR.
 - If the power fails for more than one minute, programmed timer recordings will be lost. When you use the VCR with the auto clock function turned OFF, repeat the steps on page 10 before re-programming the timer recordings.
 - To cancel a Timer Recording with VCR Plus+, follow the steps for Checking or Clearing Timer Recordings on page 20.
- See page 35 for more notes.

Follow the steps below to program a timer recording using VCR Plus+ numbers. Before you begin, make sure:

- Channels have been programmed.
- The clock has been set.
- There is a tape in the VCR. Make sure the tape's record tab is intact and the tape is long enough to record the program(s).
- The VCR is in VCR position.
- You have selected CABLE TV or TV at the TUNER SET UP menu.
- You have completed the steps on pages 22-24.

You must do each step within 60 seconds of completing the previous step. If you don't, you will have to start again at step 1.

1

Press the VCR PLUS+/ENTER button on the remote control. The on-screen display shown below will appear.

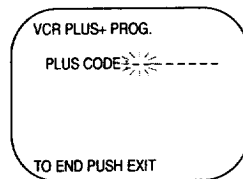

2

Use the Number buttons to enter the VCR Plus+ number of the program you wish to record (this number is different for every program, and it can be four to eight digits long). Finally, press the VCR PLUS+/ENTER button.

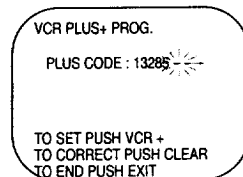

3

To record the program once, press the Number 1 button to select ONCE. To record the same program every day from Monday through Friday, press the Number 2 button to select DAILY. To record the same program every week on the same day (such as every Saturday), press the Number 3 button to select

4

Press the Number 1 button to record in SP speed, press the Number 2 button to record in LP speed, or press the Number 3 button to record in SLP speed. For details, see page five. You cannot use the (Tape) SPEED button at this time.

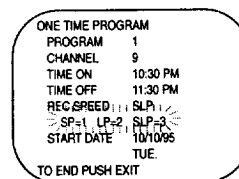

5

Press the STATUS/EXIT button. PROGRAM WAS COMPLETED / PLEASE TURN OFF VCR FOR TIMER RECORDING should appear on the screen. After three seconds, the on-screen display will disappear.

6

To program additional timer recordings with VCR Plus+, press the VCR PLUS+/ENTER button and repeat steps 2-5. When you are finished, go to step 7.

7

Turn off the VCR power. The Timer light will appear. The Timer light will flash if there is not a tape in the VCR. **The VCR must be turned off for a timer recording to take place.** If you forget to turn the VCR off, PLEASE TURN OFF VCR FOR TIMER RECORDING flashes on your TV screen two minutes before a timer recording starts. You can remove it by pressing the CLEAR button.

**The VCR
must be off for a
timer recording
to take place!
Make sure there
is a tape in the**

Rerecording (Tape Duplication)

The instructions on this page show you how to copy tapes. The illustration uses two VCRs just like yours. Different VCRs may operate differently.

NOTE: Unauthorized recording of copyrighted television programs, video tapes, or other materials may infringe on the rights of copyright owners and violate copyright laws.

1 VCR 1 will play your tape. Insert a prerecorded tape in VCR 1. If the tape does not have a record tab, playback begins. If this happens, press the STOP/EJECT button on VCR 1 once.

2 VCR 2 will record your tape. Insert a blank tape in VCR 2. Make sure the VCR 2 power is on and VCR 2 is in VCR position.

3 Turn the TV on and set it to channel 3 or 4, whichever channel the CH3/CH4 switch on VCR 2 is set to.

4 Point the remote control at VCR 2. Press the Number buttons 0, 0. A/V IN will appear on-screen.

5 Point the remote control at VCR 2. Use the (Tape) SPEED button to select SP, LP or SLP.

6 Press the PLAY button on VCR 1 and the REC(ord)/OTR button on VCR 2 at the same time.

Connections

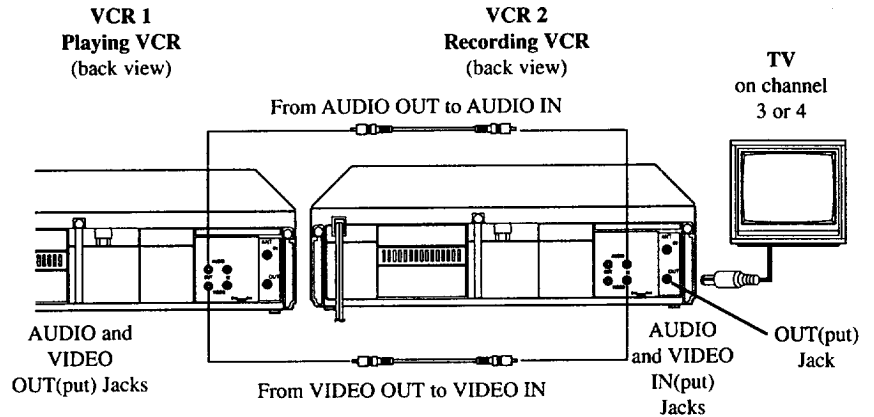

Audio and video cables are not included.

Operation

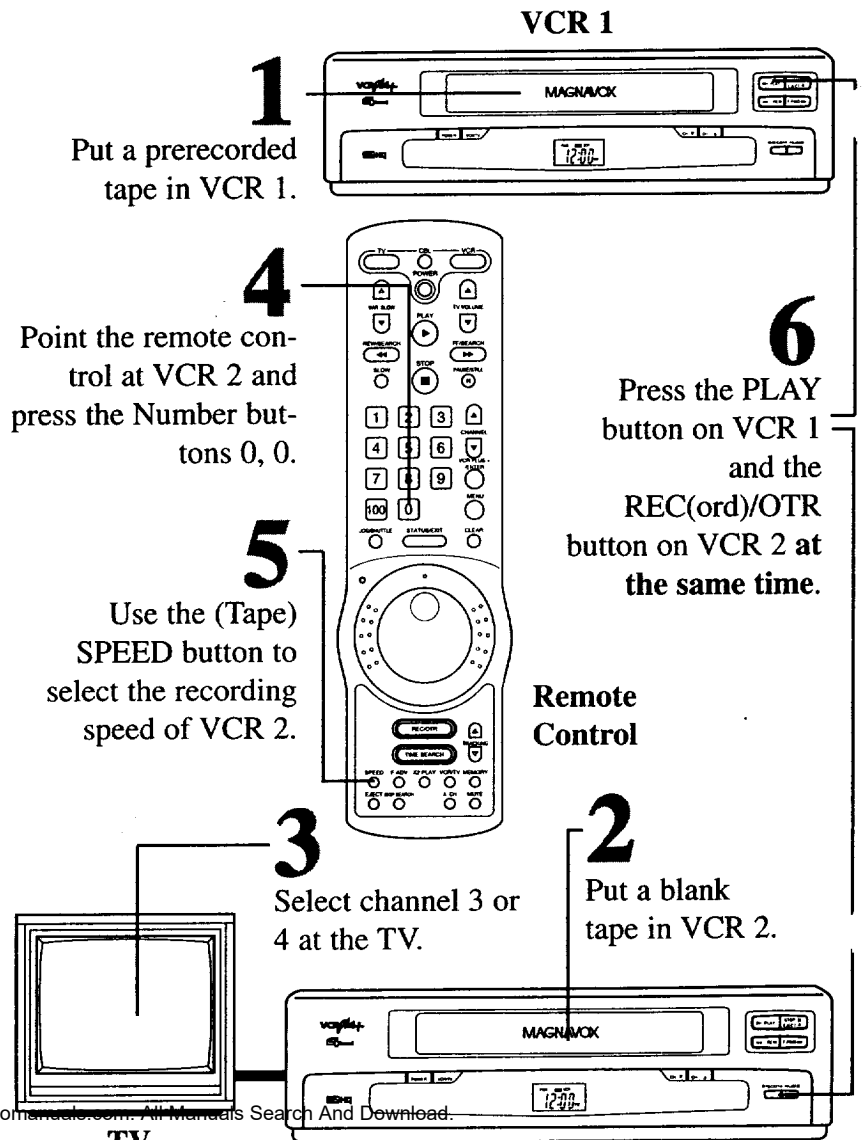

Channel Memor.

Remote Control

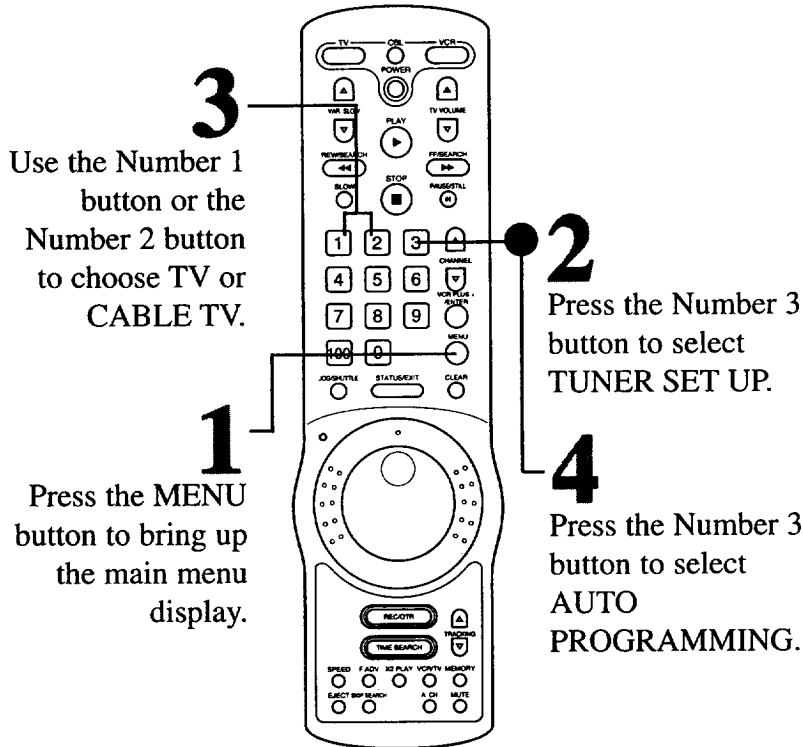

Programming Channels

Although your VCR may automatically memorize the channels you receive when you turn it on for the first time, this function lets you reprogram channels.

1

Press the MENU button to bring up the main menu display.

TO SELECT PUSH NO. SHOWN

1	PROGRAM
2	VCR SET UP
3	TUNER SET UP
4	SET CLOCK

TO END PUSH EXIT

2

Press the Number 3 button to select TUNER SET UP.

TO SELECT PUSH NO. SHOWN

1	TV	ON
2	CABLE TV	
3	AUTO PROGRAMMING	
4	ADD/DELETE CH	
5	CH MEMORY REVIEW	

TO END PUSH EXIT

3

Press the Number 1 button to select TV (if you have an antenna) or the Number 2 button to select CABLE TV (if you have a cable connection).

4

Press the Number 3 button to select AUTO PROGRAMMING. MEMORIZED CHANNEL / PLEASE WAIT will appear on-screen. The VCR will place all the channels you receive into its memory.

5

Wait for a few minutes while the VCR programs channels. When programming is complete, AUTO SET COMPLETED will appear on-screen. Then the programming of the lowest channel number placed in the VCR's memory will appear on-screen. Now when you press the CHANNEL (Up/Down) buttons, you will scan only through channels you receive.

- Line Input mode will always be stored in the VCR's memory as channel 00. When you select channel 00 with the CHANNEL (Up/Down) buttons or the Number buttons, A/V IN will appear on the screen.
- You cannot program channels if a cable converter box is connected to a VCR that is connected to a TV. If you have this kind of connection, see pages 38-39 for details.
- To change TV or CABLE TV selection, repeat the steps on this page.

Channel Memory (cont'd)

Adding/Deleting Channels

1

Press the MENU button, then press the Number 3 button to select TUNER SET UP.

2

Press the Number 4 button to select ADD/DELETE CH.

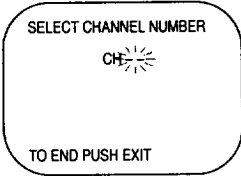

3

Enter the desired channel number (see "Number Buttons" on page 14).

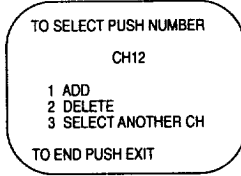

4

Press the Number 1 button to add that channel or the Number 2 button to delete that channel. Press the Number 3 button to leave that channel unchanged and select another channel. If you do not make a choice within five seconds, you will return to the previous menu display.

5

Press the STATUS/EXIT button to exit. The programming of the channel you added or deleted will appear.

Remote Control

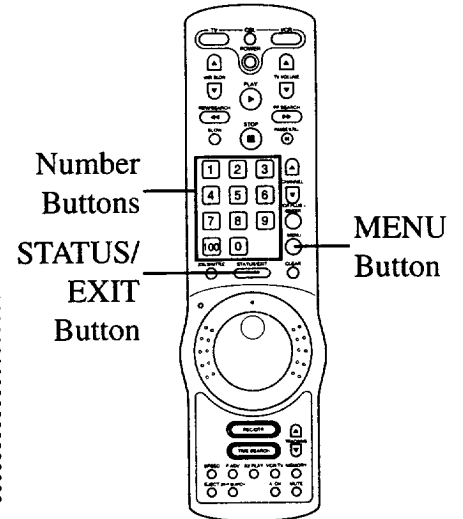

Reviewing Programmed Channels

1. Press the MENU button to bring up the main menu display.
2. Press the Number 3 button to select TUNER SET UP.
3. Press the Number 5 button to select CH MEMORY REVIEW. A list of programmed channels will appear on-screen.
 - If all the programmed channels don't fit on the screen, press the Number 1 button to see the remaining channels. Then press the Number 2 button to return to the first screen of channels.
 - If you do not press any buttons within 10 seconds, you will return to the previous menu display.
4. Press the STATUS/EXIT button twice to exit.

Language Selection

Follow the steps below to change the language of the on-screen displays.

1

Press the MENU button, then press the Number 2 button to select VCR SET UP. Press the Number 4 button to select LANGUAGE.

2

Press the Number 1 button if you want the on-screen displays in English. ON will appear to the right of ENGLISH on-screen. Press the Number 2 button if you want the on-screen displays in Spanish. SI will appear to the right of ESPAÑOL on-screen.

3

Press the MENU button to exit

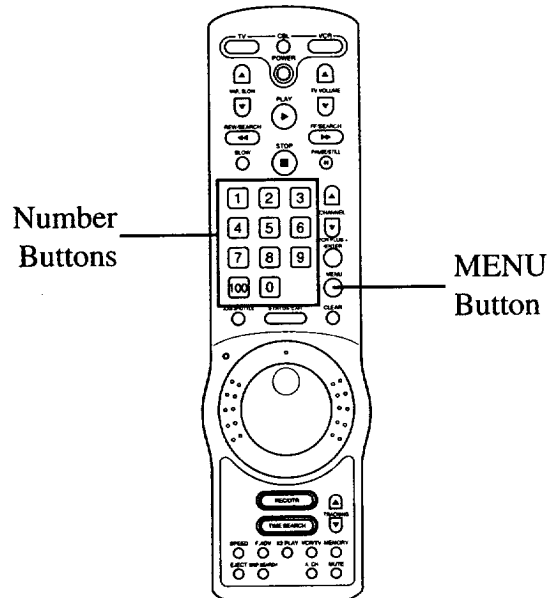

Playback Options

Repeat Playback

1 Press the MENU button, then press the Number 2 button to select VCR SET UP.

2 Press the Number 2 button to select REPEAT PLAY.

3 Press the STATUS/EXIT button to exit.

Remote Control

Time Search

1 In Stop mode, press the TIME SEARCH button to bring up the time search display.

2 Use the Number buttons to enter the desired length of time.

3 Press the FF/SEARCH button or the REW(ind)/SEARCH button to skip forward or backward.

Remote Control

Repeat Playback

Follow the steps below to program the VCR to play a tape over and over.

- 1** Press the MENU button, then press the Number 2 button to select VCR SET UP.
- 2** Press the Number 2 button to select REPEAT PLAY. ON will appear to the right of REPEAT PLAY on-screen.
- 3** Press the STATUS/EXIT button to exit. Now, when a tape has finished playing, the VCR will rewind it and start playback again. (TV programming will appear while the tape is rewinding.)

Time Search

Follow the steps below to program the VCR to search forward or backward a specific length of time.

- 1** While in Stop mode, press the TIME SEARCH button to bring up the time search display.
- 2** Use the Number buttons to enter the desired length of time you want to skip forward or backward. For example, for 1 hour, 25 minutes, press the Number buttons 1, 2, 5. Or, for five minutes, press the Number buttons 0, 0, 5. (You must make an entry within 10 seconds of pressing the TIME SEARCH button. Otherwise, the VCR will cancel Time Search mode.)
- 3** Press the FF/SEARCH button or the REW(ind)/SEARCH button to skip forward or backward. The VCR will skip over the specified length of time, then begin playback.

- The VCR will stay in Repeat Play mode until you cancel Repeat Play mode. To do this, follow step 1 under "Repeat Playback." At step 2, press the Number 1 button to select NORMAL PLAY. Press the STATUS/EXIT button to exit.
- The time counter memory does not function when the VCR is in Repeat Play mode.
- You can exit Time Search mode by pressing the TIME SEARCH button again.
- To cancel Time Search mode when the VCR is fast forwarding or rewinding, press the STOP button.

Playback Options (cont'd)

Time Counter Memory

Follow the steps below to reset the time counter to zero at a tape location you want to refer to later.

1

Play, fast forward, or rewind a tape to the location that you would like to refer to later. Press the STOP button or the STOP/EJECT button to stop the tape.

2

Press the STATUS/EXIT button. The status display will appear on-screen for about five seconds.

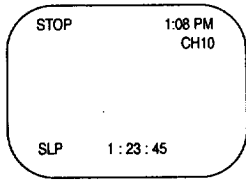

3

While the status display is still on-screen, press the CLEAR button to reset the time counter to zero.

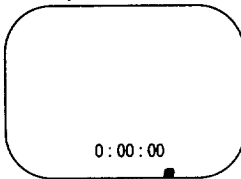

4

While the time counter is still on-screen, press the MEMORY button to set the time counter memory. M will appear to the left of the time counter on-screen.

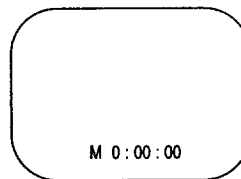

5

To go to a tape location where the time counter was reset to zero, press the REW(ind)/SEARCH button or the FF/SEARCH button when in Stop mode. When the tape reaches the point at which the time counter was reset to zero, the tape will stop. Press the PLAY button to watch the

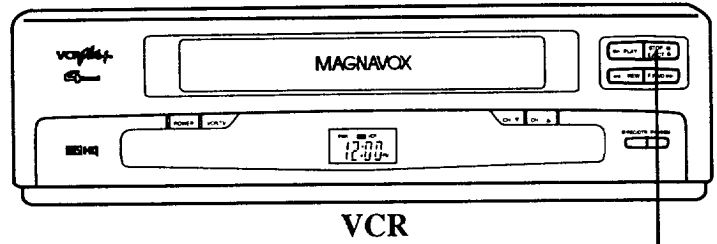

VCR

1

Play, fast forward, or rewind a tape to the location that you would like to refer to later. Press the STOP button or the STOP/EJECT button to stop the tape.

5

When in Stop mode, press the REW(ind)/SEARCH button or the FF/SEARCH button to go to a tape location where the time counter was reset to zero.

2

Press the STATUS/EXIT button to bring up the status display.

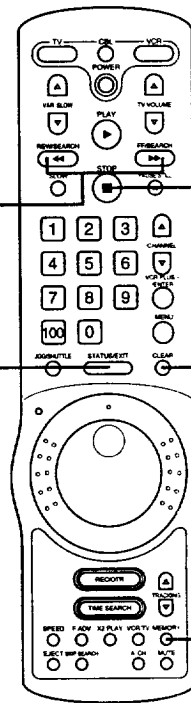

Remote Control

3

Press the CLEAR button to reset the time counter to zero.

4

Press the MEMORY button to set the time counter memory.

- The MEMORY button does not function during Repeat Playback.
- The VCR must be in Normal Play mode before you can set the Time Counter Memory. See Notes on page 29 for details on putting the VCR in Normal Play mode.
- To erase a Time Counter Memory, press the MEMORY button twice. The M will disappear from the screen.
- You may only set the time counter to zero at one location at a time. If you try to set the time counter to zero at a second location, the previous time counter to zero setting will be erased.

Playback Options (cont'd)

Forward and Reverse Searching (SP/LP/SLP)

- 1 When in Play mode, press and release the FF/SEARCH button or the REW(ind)/SEARCH button. A fast forward or reverse picture search will begin.
- 2 To return to playback, press the PLAY button.

Super High Speed Searching (LP/SLP)

- 1 When in Play mode, press and release the FF/SEARCH button or the REW(ind)/SEARCH button, then press again. The VCR will now search in super high speed.
- 2 To return to normal playback, press the PLAY button.

Playing a Tape at Double Speed

- 1 When in Play mode, press the X2 PLAY button. The picture will run at twice normal playback speed.
- 2 To return to normal playback, press the X2 PLAY button again or press the PLAY button.

Viewing a Still Picture

- 1 When in Play mode, press the PAUSE/STILL button. A still picture (frozen image) will appear on-screen.
- 2 To advance the still picture frame-by-frame, press the F(rame). ADV(ance) button.
- 3 To release the still picture and return to normal playback, press the PLAY button or press the PAUSE/STILL button again.

Viewing a Slow Motion Picture

- 1 When in Play mode, press the SLOW button. The tape will play in slow motion.
NOTE: You can control the speed of slow motion playback by pressing the VAR(iable). SLOW buttons.
- 2 To release Slow mode and return to normal playback, press the SLOW button again or press the PLAY button.

Viewing a Picture in Slow to Fast Motion

- 1 Press the JOG/SHUTTLE button while in the Play or Still mode. The Jog/Shuttle Light comes on. If you do not operate the Jog Dial or Shuttle Ring within 30 seconds, the Jog/Shuttle light will go off.
- 2 Turn the Shuttle Ring in either direction and hold it. The more the ring is rotated, the faster the search speed will be. Releasing the ring stops the picture in the Still mode.
- 3 Turn the Jog dial in either direction for frame-by-frame control. The faster the dial is rotated, the faster the search will be. Releasing the dial stops the picture in the Still mode.
- 4 Press the PLAY button to release the Still mode.

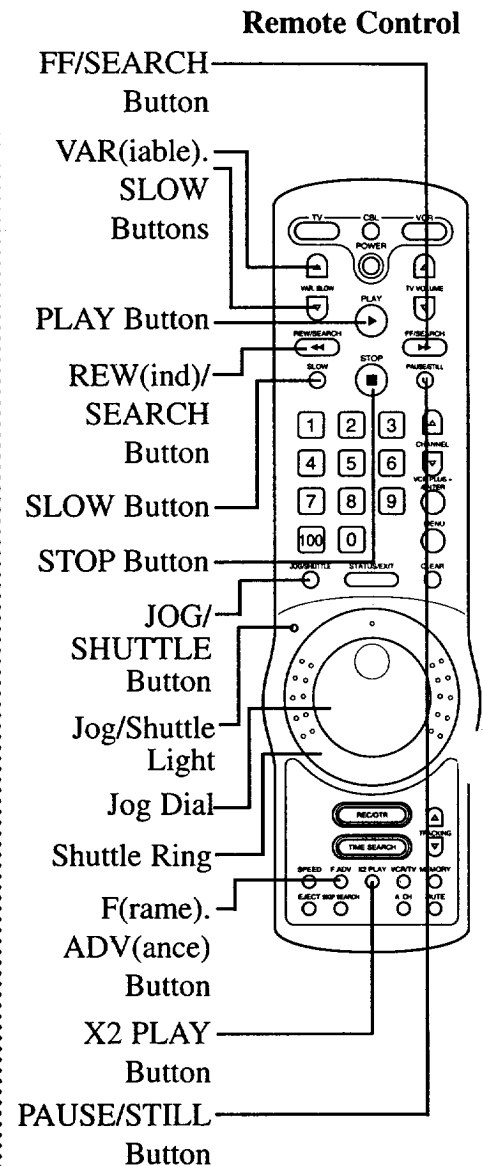

- Still and Slow modes will automatically switch to Stop mode after five minutes to protect the VCR and the tape from damage.
- SP/LP/SLP means this feature will work with tapes recorded in Standard Play, Long Play, or Super Long Play. For details on tape speed, see page five.
- LP/SLP means this feature will work with tapes recorded in Long Play and Super Long Play. For details on tape speed, page five.
- If a still picture vibrates vertically, stabilize it by pressing the TRACKING (Up/Down) buttons (any other vertical jitter should be removed with your TV's vertical hold control, if your TV has one).

Playback Features

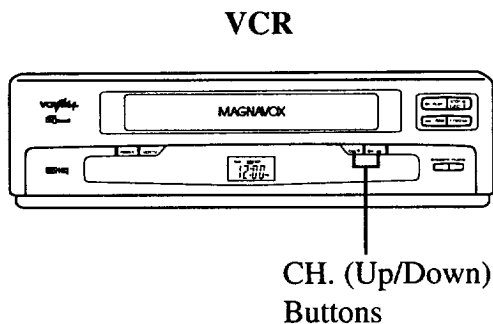

Remote Control

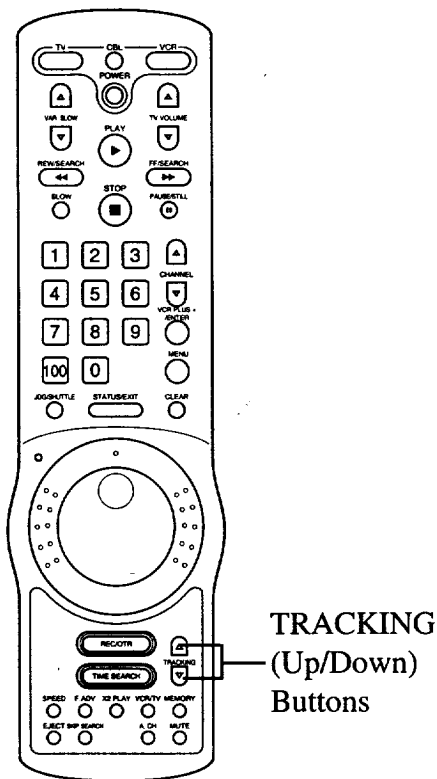

The following playback features will always operate:

Automatic Playback

When you put a tape in the VCR, the power will come on automatically. If the tape's record tab is missing, playback will begin.

Automatic Rewind, Eject, Off

When a tape is played, fast forwarded, or recorded to its end, the VCR will rewind the tape, go into the Stop mode, eject the tape, then turn itself off. If the time counter memory is set, the VCR will only rewind to the point at which the counter is set to zero, then stop. The VCR will not eject the tape automatically or shut itself off.

Tape Eject

A tape can be ejected with the VCR power on or off (but the VCR must be plugged in). If a Timer Recording is programmed, a tape can only be ejected with the power on. Make sure you insert a tape for the Timer Recording.

Auto Tracking

The VCR has automatic tracking, which continually adjusts tracking to give you the best possible picture quality. With some recordings, however, you may get a better picture using the manual tracking controls (see below).

Manual Tracking

To adjust the tracking manually, press the TRACKING (Up/Down) buttons on the remote control.

NOTES:

- To return tracking to the position it was in when the VCR was shipped from the factory, press the CH. (Up) and CH. (Down) buttons **on the VCR** at the same time. This function is controlled only by the buttons **on the VCR**. The CHANNEL (Up/Down) buttons on the remote control will not adjust tracking.
- Tracking is returned to auto tracking when a tape is inserted, or when the STOP button is pressed to halt playback.
- The CH. (Up/Down) buttons **on the VCR** also adjust tracking when the VCR is in Play mode.
- When the VCR is in Slow mode, auto tracking will not work. Instead, use the TRACKING (Up/Down) buttons or the CH. (Up/Down) buttons **on the VCR** to reduce noise lines in slow motion playback.
- Manual tracking will not operate when the VCR is in Still mode. If you want to reduce noise lines in a still picture, place the VCR in Slow mode. Use the TRACKING (Up/Down) buttons to remove the noise lines. Then return to Still mode.

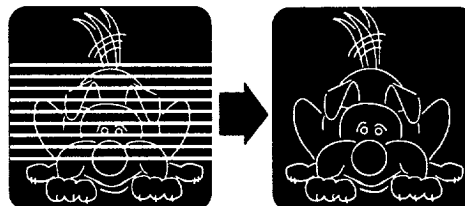

TV Code Setting

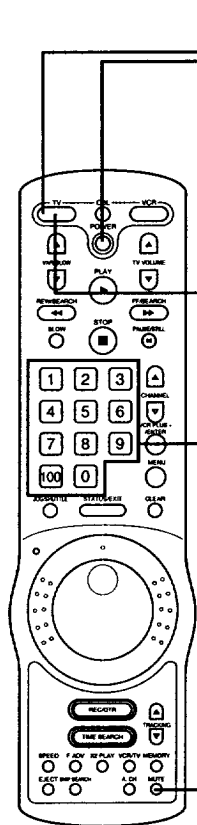

Remote Control

1 Press the TV button, then the POWER button, to see if the remote control operates your TV. If it doesn't, go to step 2.

4 Press and release the TV button.

5 Use the Number buttons to enter your TV's code (from the list below).

3 Press and release the MUTE button.

6 Try step 1 again. If the remote control works your TV, you're finished. If the remote control still doesn't work your TV, repeat steps 2 - 5 using another code.

2 Find the brand of your TV on this list.

TV CODES	
MAGNAVOX01
GE04
GOLDSTAR15
GOLDSTAR16
GOLDSTAR17
HITACHI12
JVC11
MITSUBISHI13
PANASONIC02
PANASONIC03
PHILCO01
PHILIPS01
RCA04
SAMSUNG14
SANYO10
SHARP06
SHARP07
SONY08
SYLVANIA01
TOSHIBA09
ZENITH05

Your VCR remote control may be able to operate your TV. If the remote control doesn't operate your TV now, find your brand of TV on the list at the left, then follow the steps below to program your remote control accordingly.

1 Point the remote control at your TV and press the TV button. Then, press the POWER button. If your TV comes on, try the other TV buttons (see pages 14 - 15 for details). If your TV doesn't come on, or if the other buttons don't work, go to step 2.

2 Find the brand of your TV on the list at the left, and remember the two-digit number to the right of it.

3 Press and release the MUTE button.

4 Within 30 seconds after releasing the MUTE button, press and release the TV button.

5 Within 30 seconds after releasing the TV button, use the Number buttons to enter the code for your TV brand. For example, if you have a Zenith TV, press Number buttons 0, 5.

6 Try step 1 again. If the remote control works your TV, you're finished. If the remote control still doesn't work your TV, repeat steps 2 - 5, using another code.

- Although the remote control that comes with your VCR will work most Magnavox TVs, as well as many TVs sold under other brand names, it is possible that the remote control will not operate your TV.
- If you had to program the remote control to operate your TV here, whenever you replace the batteries in the remote control, you will have to program the remote control again.

There is no guarantee that the remote control will work your TV.

Cable Converter Box Code Setting

Your VCR remote control may be able to operate your cable converter box. If the remote control doesn't operate your cable converter box now, find your brand of cable converter box on the list at the right, then follow the steps below to program your remote control accordingly.

1

Point the remote control at your cable converter box and press the CBL button. Then, press the POWER button. If your cable converter box comes on, try the other cable converter box buttons (see pages 14 - 15 for details). If your cable converter box doesn't come on, or if the other buttons don't work, go to step 2.

2

Find the brand of your cable converter box on the list at the right, and remember the two-digit number to the right of it.

3

Press and release the MUTE button.

4

Within 30 seconds after releasing the MUTE button, press and release the CBL button.

5

Within 30 seconds after releasing the CBL button, use the Number buttons to enter the code for your cable converter box. For example, if you have a Zenith cable converter box, press Number buttons 1, 3.

6

Try step 1 again. If the remote control works your cable converter box, you're finished. If the remote control still doesn't work your cable converter box, repeat steps 2 - 5, using another code.

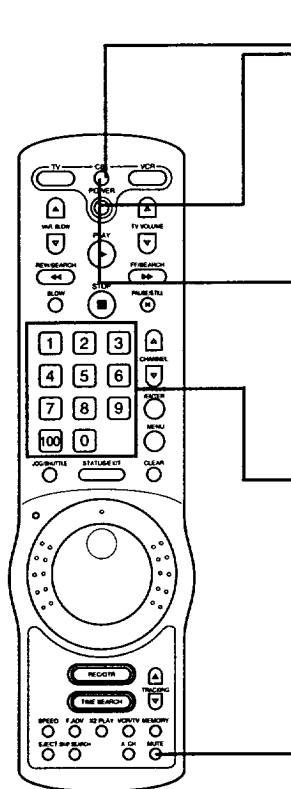

Remote Control

1 Press the CBL button, then the POWER button, to see if the remote control operates your cable converter box. If it doesn't, go to step 2.

4 Press and release the CBL button.

5 Use the Number buttons to enter your cable converter box's code (from the list below).

3 Press and release the MUTE button.

6 Try step 1 again. If the remote control works your cable converter box, you're finished. If the remote control still doesn't work your cable converter box, repeat steps 2 - 5 using another code.

2 Find the brand of your cable converter box on this list.

CABLE CONVERTER BC CODES	
JERROLD	.01
JERROLD	.02
JERROLD	.03
JERROLD	.04
JERROLD	.05
JERROLD	.06
JERROLD	.07
HAMLIN	.21
HAMLIN	.22
OAK	.16
OAK	.17
OAK	.18
PANASONIC	.19
PANASONIC	.20
PIONEER	.11
PIONEER	.12
SCIENTIFIC ATLANTA	.08
SCIENTIFIC ATLANTA	.09
SCIENTIFIC ATLANTA	.10
TOCOM	.23
TOCOM	.24
TOCOM	.25
ZENITH	.13
ZENITH	.14
ZENITH	.15

There is no guarantee that the remote control will work your cable converter box.

- Although the remote control that comes with your VCR will work most cable converter boxes, it is possible that the remote control will not operate your cable converter box.
- If you had to program the remote control to operate your cable converter box here, whenever you replace the batteries in the remote control, you will have to program the remote control again.

Specifications

Video Heads
Four heads

Video Signal
EIA standards: NTSC color

Antenna
VHF/UHF - 75 ohm external antenna terminal

VHF Input Signal
Channel 3 or 4 (switchable)
75 ohm impedance

Power Requirements
120V AC, 60Hz

Power Consumption
17W

Operating Temperature
40°F (5°C) to 104°F (40°C)

Relative Humidity
10% to 80%

Weight
7.7 lbs (3.5 kg)

Dimensions
14 3/16" (W) x 8 1/2" (D) x 11" (H)
(360 mm x 215 mm x 280 mm)

Tuner Broadcast Channels
VHF 2, 3, UHF 13-53

CATV Channels
Midband A-31
Superband L-3W
Highband A-3
Special Channel 5A
UltraBand 07-12, 14, 15, 16, 17

NOTE: Designs and specifications are subject to change without notice.

Hooking Up Your VCR

If the reception on all channels is poor, you may need to tune your TV set again.

Timer Recording

- It is best to finish programming a timer recording at least five minutes before the recording is scheduled to begin.
- If, after programming a timer recording, you turn the VCR power off without putting a tape in the VCR, the Timer light will blink.
- If the record tab on a tape is missing, the VCR will eject the tape. The Timer light will blink.
- 12 PM is noon; 12 AM is midnight.

Power Failure

Timer recordings may be lost if the power fails for more than one minute. When you use the VCR with the auto clock function set to OFF, the clock setting may be lost. Follow the steps on page 10.

Satellite Hookups

- Watching one TV channel while recording another may not be possible if you have a satellite hookup.
- You may have to set your TV to channel 3 or 4, then make your channel selections at the satellite converter box.
- With many satellite hookups, if you use accessory audio and video cables to connect your VCR to your TV, you will have to put your VCR in Line Input mode. To enter Line Input mode, press 0, 0. A/V IN will appear on your TV screen briefly.

Line Input

If you accidentally enter Line Input mode (A/V IN will appear on your TV screen briefly), press the CHANNEL (Up/Down) buttons or use the Number buttons to select another channel.

Daylight-Saving Time

When automatic Daylight-Saving Time is set, the clock time will change automatically as follows: on the first Sunday in April, from 2:00 AM to 3:00 AM; on the last Sunday in October, from 2:00 AM to 1:00 AM.

- During the April time change, a timer recording programmed to start between 2:00 AM and 2:59 AM will not record. A timer recording programmed to end between 2:00 AM and 2:59 AM will end when the clock moves forward (2:00 AM).
- During the October time change, a recording cannot be started between the second 1:00 AM and 1:59 AM.

Other Hookups

Antenna/Cable to VCR to TV Hookups

1 Disconnect the antenna or cable from your TV (to avoid confusion, label all cable ends and jacks on the TV before disconnecting anything).

2 Connect the antenna or cable to your VCR.

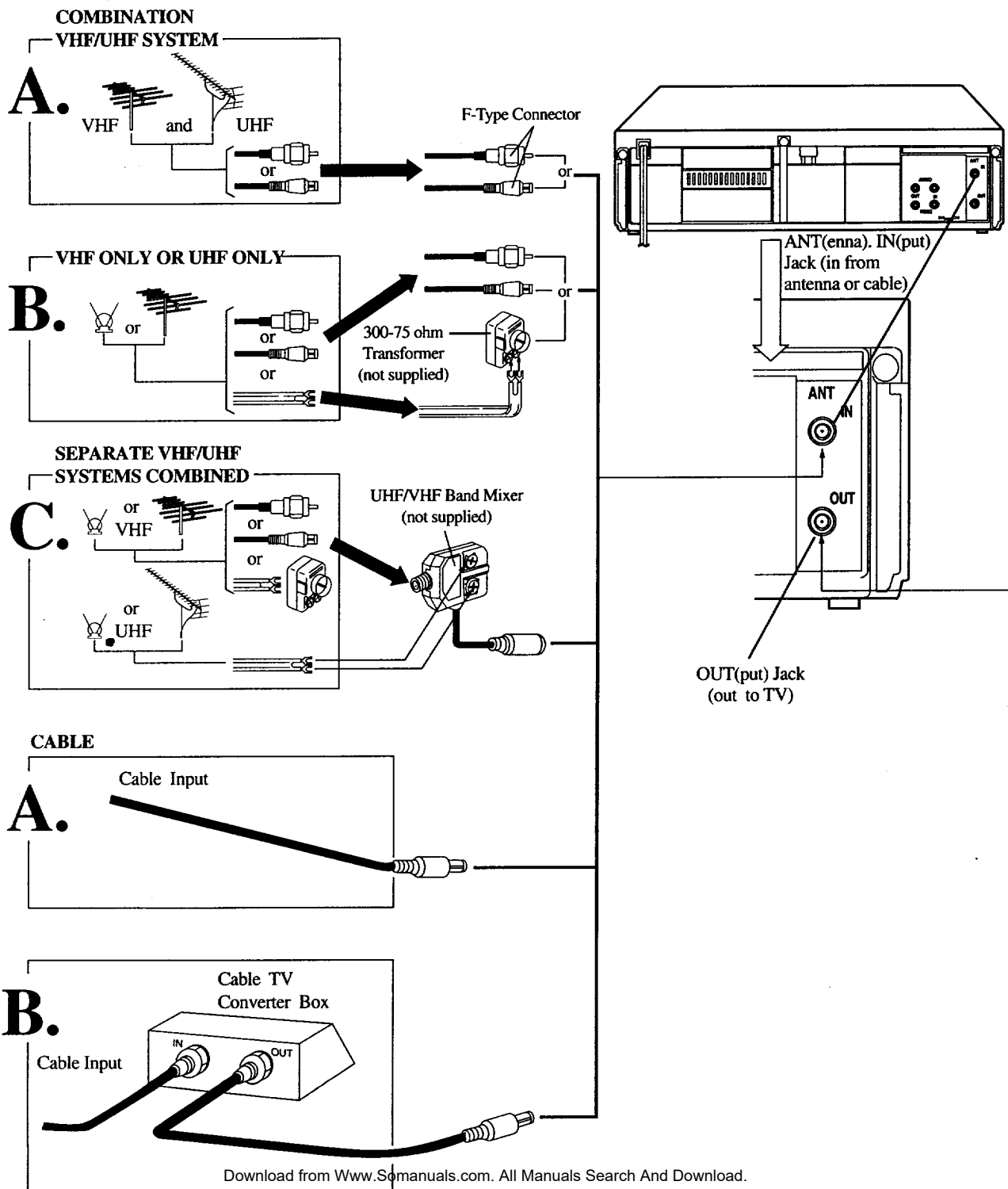

Other Hookups (cont'd)

3 Connect your VCR to your TV, using only one of the connections shown below.

4 Select channel 3 or 4 at the back of the VCR.

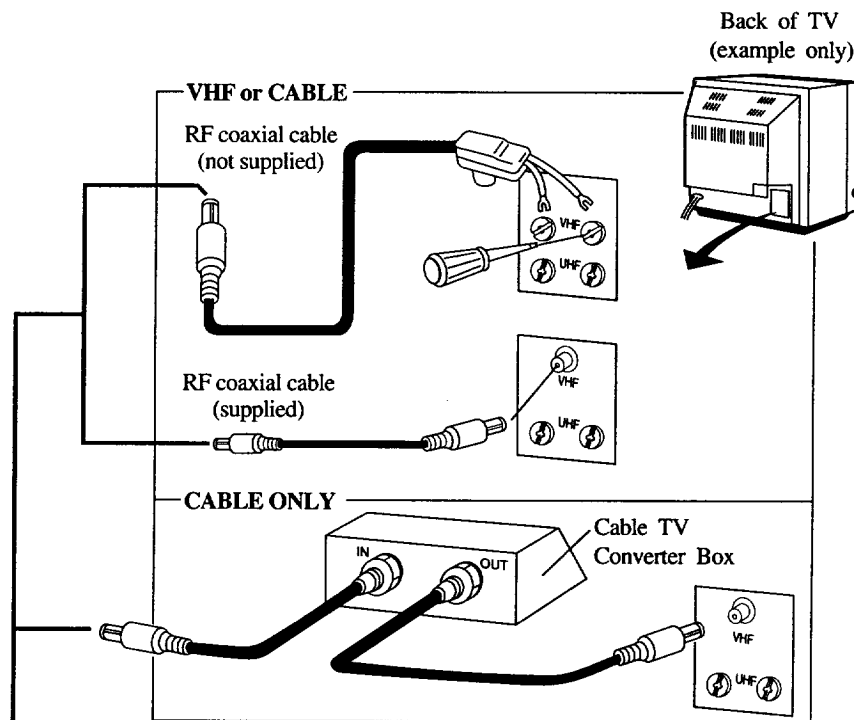

If you have a UHF-only antenna system: Even if you only plan to play tapes and view/record UHF channels, you still need to make one of the combination UHF/VHF connections shown. This is because when your VCR operates, it sends VHF signals to the TV across the RF coaxial cable. You may connect the cable TV converter box two different ways. See pages 38-39 before you choose how to connect the cable TV converter box.

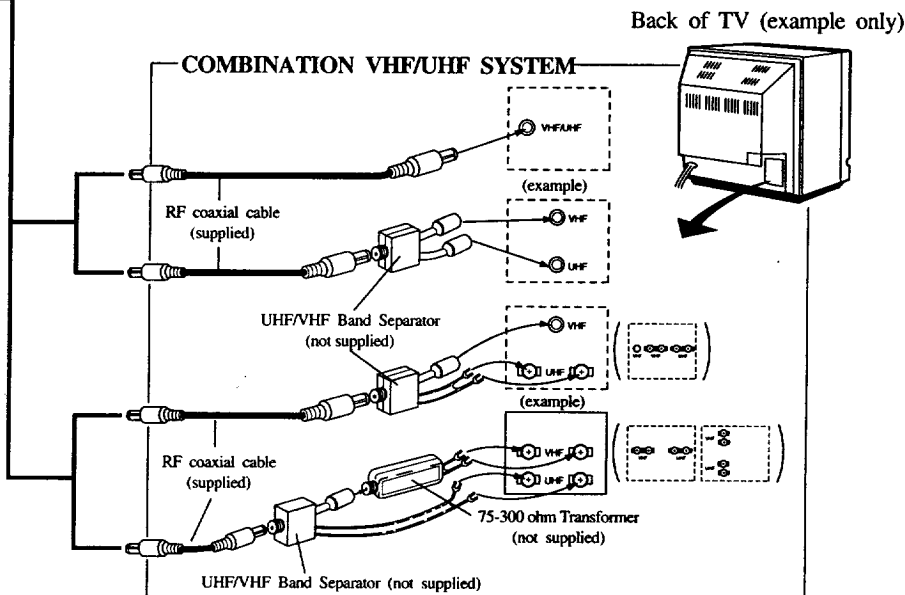

Other Hookups (cont'd)

With a Converter/Descrambler Box

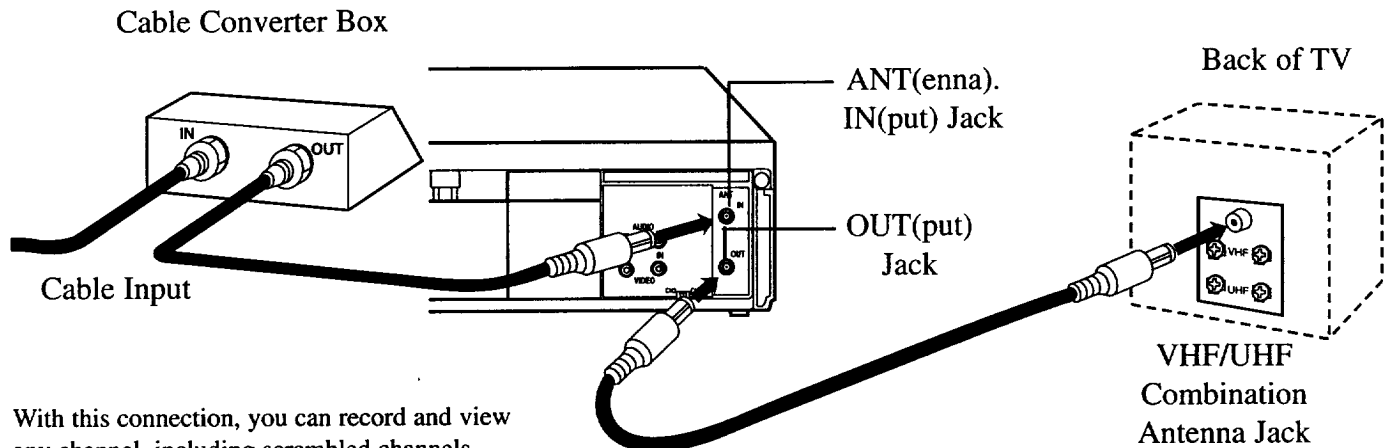

With this connection, you can record and view any channel, including scrambled channels. However, channel selections must be made at the cable converter box. This means that:

- You can record any channel by using your remote control to select channels at the cable converter box (see "Cable Converter Box Code Setting" on page 34).
- Timer recordings are programmed differently than shown on pages 20 - 25.
 - You can only program a timer recording for one channel at a time.
 - When you are prompted to enter the channel you want to record, select channel 3 or 4 (whichever is the output channel of your cable converter box).
 - Set your cable converter box to the channel you want to record.
 - Leave the cable converter box on while you are recording.
- You cannot view a channel other than the one you are recording (the instructions on page 18 do not work with this hookup).
- You cannot program channels with this hookup (as discussed on pages 7 and 27).

Recording and Viewing a Scrambled or Unscrambled Channel

1

With the VCR on and in VCR position, use the CHANNEL (Up/Down) buttons to set the VCR to the output channel of the cable converter box (channel 3 or 4).

2

Set the TV to the same channel to which you set the VCR.

3

Select the channel you want to record at the cable converter box.

Watching TV With the VCR Off

1

Use the TV channel selector to set the TV to the same channel as the output channel of the cable converter box.

2

Use the cable converter box channel selector to select the channel you want to watch.

- To program a timer recording with this hookup, see "Timer recordings are programmed differently..." above left.
- The cable converter box must be on during recording.

Other Hookups (cont'd)

With a (VCR to TV) Converter/Descrambler Box

This is an alternative to the connection shown on page 38. It allows you to program an unattended recording of more than one unscrambled channel and to watch one channel while recording another.

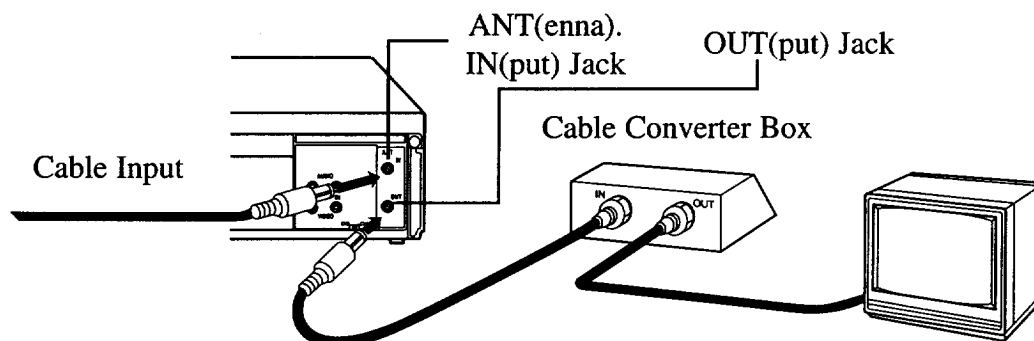

Recording One Channel/ Watching Another

1

With the VCR in VCR position, use the CHANNEL (Up/Down) buttons to select the channel you want to record. Start the recording.

2

Use the VCR/TV button to put the VCR in TV position.

3

Use the TV channel selector to put the TV on the same channel as the output channel of the cable converter box.

4

Select the channel you want to watch at the cable converter box.

Playing a Tape

1

Put the VCR in VCR position.

2

Use the TV channel selector to put the TV on the same channel as the output channel of the cable converter box.

3

Make sure the cable converter box is on the same channel as the VCR CH3/CH4 switch.

You cannot record scrambled channels with this connection.

VCR to Stereo TV Hookups

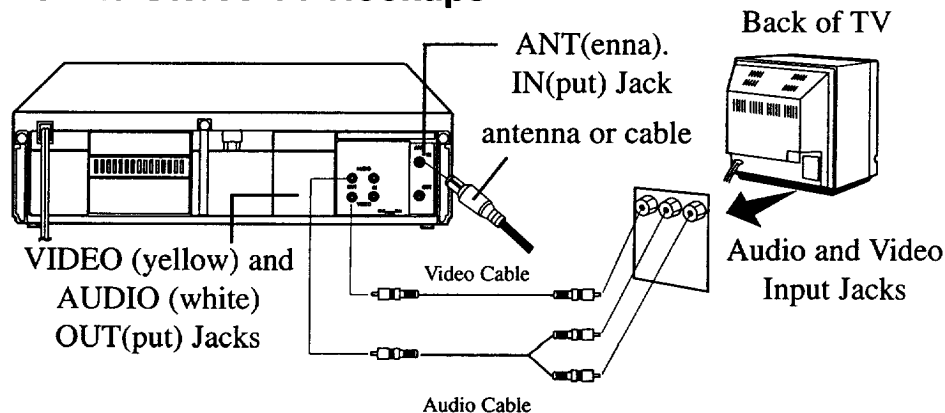

- A "Y" splitter audio cable (not supplied) is used here to deliver audio to the TV's left and right channels.
- Cables are not supplied.
- The TV must be in Line Input mode. Please refer to your TV owner's manual.
- This hookup will not give you stereo sound. To get stereo sound, use the connections on page six and select the channel to be viewed at the TV (with the VCR turned off).

Before Requesting Service

.....

If you are having problems with your VCR, check the following list of problems and possible solutions before requesting service. You may be able to solve the problem yourself.

Power

No power

- Make sure the power plug is completely connected to an AC (alternating current) outlet.
- Make sure the power is turned on.

Power failure

- When you use the VCR with auto clock function OFF, follow the steps on page 10 to reset the clock.

Recording/Playback

A TV program cannot be recorded.

- Check the connections between the VCR, TV, and antenna/cable (page six).
- Make sure the band selected (VHF/UHF) matches your antenna/cable system.
- Make sure the tape has a record tab (page five).

The VCR will not perform a timer recording.

- Make sure the recording start and stop times are set correctly (pages 20-25).
- Make sure a tape is in the VCR and the tape has a record tab (page five).
- Make sure the VCR power is off.
- Make sure the clock is set (pages 10-11).
- The VCR may not perform or continue a timer recording if a power interruption of more than one minute occurs during the timer recording, even if the power comes back on afterward.

There is no playback picture, or the playback picture is noisy or contains streaks.

- Make sure the TV is on the same channel as the VCR's CH3/CH4 switch (page six).
- Make sure the VCR is in VCR position (pages 13, 15-16).
- Make sure channel 3 or 4 is properly adjusted.
- Adjust the tracking (page 32).

During special effects playback, the picture is noisy or contains vertical jitter when using a TV with an automatic vertical hold control.

- Set the TV's vertical hold control to manual, then adjust (see notes on page 31).

The top of the playback picture waves back and forth excessively.

- Because the VCR playback signal is not as stable as an off-the-air TV signal, the top of the TV screen may waver during playback. To stop this, slowly turn the horizontal hold control on the TV. If the TV does not have a horizontal hold control, or if adjusting the control does not help, contact your TV service center.

Remote Control

The VCR cannot be controlled with the remote control.

- Press the VCR button on the remote control, then try again.
- Aim the remote control directly at the VCR's remote sensor (page five).
- Remove all obstacles between the remote control and the VCR (page five).
- Inspect and/or replace the batteries in the remote control (page five).

The Number buttons won't work for channels above 69.

- Select CABLE TV from the tuner set up display (page 27), then let the VCR program the channels.

(continued on page 41)

Periodic maintenance is required to maintain your VCR's continued excellent performance. Your VCR has an automatic head cleaning system that helps prevent clogging of the video heads. Cleaning is performed each time you insert or remove a video cassette. However, this feature is preventative only. If the video heads are very clogged, take your VCR to an authorized service center.

(continued from page 40)

Miscellaneous

TV programs cannot be watched normally.

Tape cannot be inserted.

Tape cannot be removed.

VCR ejects the tape when the REC(ord)/OTR button is pressed or when the VCR power is turned off to set a timer recording.

The motor (cylinder) rotates even when the VCR is in Stop mode.

Channels above 13 cannot be received.

- Put the VCR in TV position (pages 13, 15-16).
- Check the connections between the VCR, your TV, and the antenna/cable (page six).
- Insert the tape, window side up, with the record tab facing you.
- Make sure a tape isn't already in the VCR by pressing the STOP/EJECT button on the VCR or the EJECT button on the remote control.
- Gently push on the center of the tape when putting it in the VCR. Never force the tape into the VCR.
- Make sure the power plug is completely connected to an AC (alternating current) outlet.
- You have set a timer recording. Turn the VCR power on, then eject the tape. Be sure to insert a tape for your timer recording.
- Make sure the tape has a record tab (page five).
- To enable the quick play mechanism, the cylinder will rotate for about five minutes. This is normal.
- Select CABLE TV from the tuner set up display (page 27), then let the VCR program the channels.

Glossary

AUDIO IN(put)/OUT(put) Jacks: jacks located on the back of the VCR which are used to record audio from another source (input) or to send audio to another source (output).

Auto Programming: process in which the VCR scans all available channels and places the ones you receive in its memory. Then, when you push the CHANNEL (Up/Down) buttons, you only scan through channels you receive.

Bands: settings that allow you to tune channels.

- **Antenna** – VHF (very high frequency; channels 2 - 13) and UHF (ultra high frequency; channels 14 - 69).
- **Cable** – all standard channels can be received without a cable converter box.

Dubbing: copying a tape using a second VCR.

Frame: a single still picture.

HQ: high quality; a feature in the VCR circuitry which provides enhanced picture detail.

Matching Transformer: an adapter, used primarily on non-cable TVs, which has a "screw on" connector on one end and two flat prongs on the other end.

OTR: one touch recording; programming a timed recording that starts immediately and records for 30 minutes to four hours, whichever you specify.

Remote Control: the small electronic unit that came with your VCR; allows you to operate your VCR from a distance.

Special Effects: forward and reverse searching, viewing a still picture.

Separator: an adapter used to separate VHF and UHF signals when connecting the TV to the VCR.

Tape Speeds: how fast the tape travels during a recording.

- **SP** (standard play) – fastest tape speed (recording time for a T120 tape is approximately two hours); best picture quality.
- **LP** (long play) – average tape speed (recording time for a T120 tape is approximately four hours).
- **SLP** (super long play) – slowest tape speed (recording time for a T120 tape is approximately six hours).

VCR: video cassette recorder.

VIDEO IN(put)/OUT(put) Jacks: jacks located on the back of the VCR which are used to record video from another source (input) or send video to another source (output).

LIMITED WARRANTY

VIDEO CASSETTE RECORDER

90 Days Free Labor

One Year Exchange Warranty on Parts

This product must be carried in for repair.

WHO IS COVERED?

You must have proof of purchase to receive warranty service. A sales receipt or other document showing that you purchased the product is considered proof of purchase.

WHAT IS COVERED?

Warranty coverage begins the day you buy your product. *For 90 days thereafter*, all parts will be repaired or replaced, and labor is free. *From 90 days to one year from the day of purchase*, all parts will be repaired or replaced, but you pay for all labor charges. *After one year from the day of purchase*, you pay for the replacement or repair of all parts, and for all labor charges.

All parts, including repaired and replaced parts, are covered only for the original warranty period. When the warranty on the product expires, the warranty on all replaced and repaired parts also expires.

WHAT IS EXCLUDED?

Your warranty does not cover:

- labor charges for installation or setup of the product, adjustment of customer controls on the product, and installation or repair of antenna systems outside of the product.
- product repair and/or part replacement because of misuse, accident, unauthorized repair or other cause not within the control of Philips Consumer Electronics Company.
- reception problems caused by signal conditions or cable or antenna systems outside the unit.
- a product that requires modification or adaptation to enable it to operate in any country other than the country for which it was designed, manufactured, approved and/or authorized, or repair of products damaged by these modifications.
- incidental or consequential damages resulting from the product. (Some states do not allow the exclusion of incidental or consequential damages, so the above exclusion may not apply to you. This includes, but is not limited to, prerecorded material, whether copyrighted or not copyrighted.)
- damage caused by the use of non-VHS tapes or tapes that have not been tested and labeled for use in two, four, six and eight hour VHS recorders.
- a product that is used for commercial or institutional purposes (including but not limited to rental purposes).

WHERE IS SERVICE AVAILABLE?

Warranty service is available in all countries where the product is officially distributed by Philips Consumer Electronics Company. In countries where Philips Consumer Electronics Company does not distribute the product, the local Philips service organization will attempt to provide service (although there may be a delay if the appropriate spare parts and technical manual(s) are not readily available).

MAKE SURE YOU KEEP...

Please keep your sales receipt or other document showing proof of purchase. Attach it to this owner's manual and keep both nearby. Also keep the original box and packing material in case you need to return your product.

BEFORE REQUESTING SERVICE...

Please check your owner's manual before requesting service. Adjustments of the controls discussed there may save you a service call.

TO GET WARRANTY SERVICE IN U.S.A., PUERTO RICO OR U.S. VIRGIN ISLANDS...

Take the product to a Philips factory service center (see enclosed list) or authorized service center for repair. When the product has been repaired, you must pick up the unit at the center. Centers may keep defective parts.

(In U.S.A., Puerto Rico and U.S. Virgin Islands, all implied warranties, including implied warranties of merchantability and fitness for a particular purpose, are limited in duration to the duration of this express warranty. But, because some states do not allow limitations on how long an implied warranty may last, this limitation may not apply to you.)

TO GET WARRANTY SERVICE IN CANADA...

Take the product to a Philips consumer service center (listed below), self-servicing dealer or authorized service depot.

Philips Electronics Ltd.

601 Milner Avenue, Scarborough, Ontario, M1B 1M8

(416) 292-5161

4977 Levy Street, St. Laurent, Québec, H4R 2N9

(514) 956-0120

1741 Boundary Road, Vancouver, B.C., V5M 3Y7

(604) 294-3441

(In Canada, this warranty is given in lieu of all other warranties. No other warranties are expressed or implied, including any implied warranties of merchantability or fitness for a particular purpose. Philips is not liable under any circumstances for any direct, indirect, special, incidental or consequential damages, howsoever incurred, even if notified of the possibility of such damages.)

REMEMBER...

Please record the model and serial numbers found on the product below. Also, please fill out and mail your warranty registration card promptly. It will be easier for us to notify you if necessary.

MODEL # _____

SERIAL # _____

-
- a. ch button15
 - ac power cord17
 - accessories44
 - antenna input jack17
 - audio input/output jacks17
 - automatic
 - clock setting11
 - playback32
 - rewind, eject, off32
 - batteries5
 - before requesting service40-41
 - cassette-inside light13
 - cassette (also see *tape*)
 - compartment16
 - cbl button14
 - ch3/ch4 switch6, 17
 - ch. up/down buttons16
 - channel
 - above 1005
 - adding28
 - deleting28
 - memory27-28
 - programming7, 27
 - reviewing28
 - up/down buttons15
 - clear button15
 - clock setting10-11
 - clock/feature display13
 - connections6, 36-39
 - contents, table of4
 - controls
 - remote5, 14-15
 - vcr13, 16-17
 - counter only mode12
 - daylight-saving time10, 35
 - display panel13
 - duplication26
 - eject button14
 - erase protection5
 - f. adv button14
 - f.fwd button16
 - ff/search31
 - ff/search button15
 - front panel16
 - glossary41
 - hookups
 - basic6
 - notes35
 - other36-39
 - input selection
 - antenna/cable6
 - line35
 - jog/shuttle
 - button14
 - light14
 - jog dial14
 - language selection7, 28
 - line input mode35
 - long play5
 - lp5
 - manual clock setting10
 - memory button15
 - menu button15
 - mute button15
 - notes35
 - number buttons14
 - on screen displays12
 - on screen off mode12
 - on screen on mode12
 - one touch recording
 - programming19
 - stopping19
 - output jack17
 - pause button16
 - pause/still button15
 - play button15-16
 - playback
 - features32
 - options29-31
 - playing8
 - power
 - button14, 16
 - cord17
 - pwr light13
 - rear panel17
 - rec/otr button15-16
 - rec light13
 - recording
 - basic9
 - one channel/watching another18
 - timer20-21
 - vcr plus+25
 - remote
 - control
 - buttons14-15
 - using5
 - sensor5
 - repeat playback29
 - rerecording26
 - rew button16
 - rew/search button14
 - rf coaxial cable6, 36-39
 - safety precautions3
 - satellite hookups35
 - searching31
 - sensor (remote)5
 - shuttle ring14
 - skip search button14
 - slow
 - button14
 - motion31
 - slp.5
 - sp5
 - speed button14
 - standard play5
 - status display12
 - status/exit button15
 - stereo tv hookups39
 - still picture31
 - stop button15
 - stop/eject button16
 - super high speed searching31
 - super long play5
 - table of contents4
 - tape
 - duplication26
 - eject32
 - speed5
 - time
 - counter memory30
 - search button14
 - (setting)10-11
 - timer
 - light13
 - recording
 - checking20
 - clearing20
 - notes35
 - setting20-21
 - tracking
 - (adjustment)32
 - buttons15
 - tv
 - button14
 - controls14-15
 - hookup6
 - position15-16
 - volume up/down buttons15
 - var. slow buttons14
 - vcr
 - button15
 - light13
 - plus+22-25
 - plus+/enter button15
 - position15-16
 - vcr/tv button15-16
 - vertical jitter31
 - video
 - input/output jacks17
 - tapes (see *tape*)
 - warranty42
 - wireless remote sensor5, 16
 - x2 play
 - button14
 - playback31

SUPPLIED ACCESSORIES

Check to be sure the items on this page are packed with your VCR. These accessories are provided to help you use or set up your VCR.

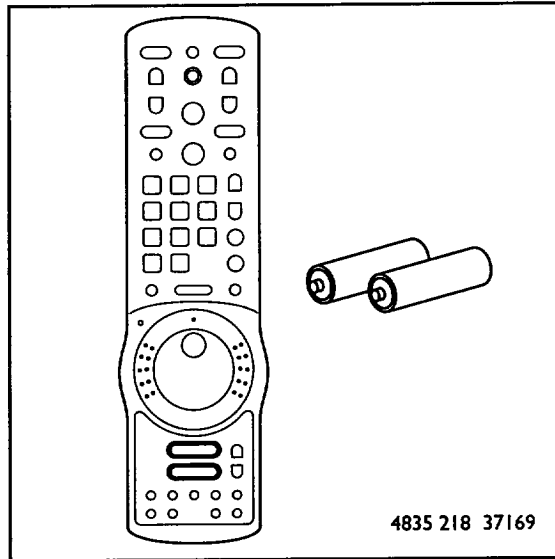

**One-Piece Wireless Remote Control
With 2 "AAA" Batteries (4835 138 17001)**

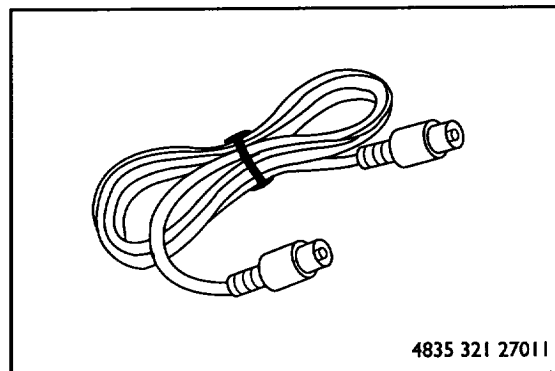

One-Piece RF Coaxial Cable, 75 ohm

If any of these items are not included, or if you need to replace an item, contact Philips Service Company at the address below.

**Philips Service Company
P.O. Box 967
Greenville, TN 37744-0967**

Or, call 1-800-851-8885.

Free Manuals Download Website

<http://myh66.com>

<http://usermanuals.us>

<http://www.somanuals.com>

<http://www.4manuals.cc>

<http://www.manual-lib.com>

<http://www.404manual.com>

<http://www.luxmanual.com>

<http://aubethermostatmanual.com>

Golf course search by state

<http://golfingnear.com>

Email search by domain

<http://emailbydomain.com>

Auto manuals search

<http://auto.somanuals.com>

TV manuals search

<http://tv.somanuals.com>