

MAGNAVOX

Smart. *Very smart.*[®]

Video Cassette Recorder

VRU442AT

Owner's Manual

IMPORTANT!

Return Your Warranty Registration Card
Within 10 Days. See Why Inside.

MAGNAVOX

Return your Warranty Registration Card today to ensure you receive all the benefits you're entitled to.

Once your MAGNAVOX purchase is registered, you're eligible to receive all the privileges of owning a MAGNAVOX product. So complete and return the Warranty Registration Card enclosed with your purchase at once. And take advantage of these important benefits.

Warranty Verification

Registering your product within 10 days confirms your right to maximum protection under the terms and conditions of your MAGNAVOX warranty.

Owner Confirmation

Your completed Warranty Registration Card serves as verification of ownership in the event of product theft or loss.

Model Registration

Returning your Warranty Registration Card right away guarantees you'll receive all the information and special offers which you qualify for as the owner of your model.

Congratulations on your purchase, and welcome to the "family!"

Dear MAGNAVOX product owner:

Thank you for your confidence in MAGNAVOX. You've selected one of the best-built, best-backed products available today. And we'll do everything in our power to keep you happy with your purchase for many years to come.

As a member of the MAGNAVOX "family," you're entitled to protection by one of the most comprehensive warranties and outstanding service networks in the industry.

What's more, your purchase guarantees you'll receive all the information and special offers for which you qualify, plus easy access to accessories from our convenient home shopping network.

And most importantly you can count on our uncompromising commitment to your total satisfaction.

All of this is our way of saying welcome—and thanks for investing in a MAGNAVOX product.

Sincerely,



Robert Minkhorst
President and Chief Executive Officer

MAGNAVOX
Smart. Very smart.®



P.S. Remember, to get the most from your MAGNAVOX product, you must return your Warranty Registration Card within 10 days. So please mail it to us right now!

For Customer Use

Enter below the Serial No. which is located on the rear of the cabinet. Retain this information for future reference.

Model No. _____ Serial No. _____

Know these safety symbols



▲ This "bolt of lightning" indicates uninsulated material within your unit may cause an electrical shock. For the safety of everyone in your household, please do not remove product covering.

▲ The "exclamation point" calls attention to features for which you should read the enclosed literature closely to prevent operating and maintenance problems.

WARNING: TO PREVENT FIRE OR SHOCK HAZARD, DO NOT EXPOSE THIS EQUIPMENT TO RAIN OR MOISTURE.

CAUTION: To prevent electric shock, match wide blade of plug to wide slot, and fully insert.

ATTENTION: Pour éviter les chocs électriques, introduire la lame la plus large de la fiche dans la borne correspondante de la prise et pousser jusqu'au fond.

MAGNAVOX Visit our World Wide Web Site at <http://www.magnavox.com>

Introduction

Features

- HQ (High Quality) System
- Frequency Synthesizer Tuning with Auto Set Feature
- On-Screen Displays in English or Spanish
- Indicator Panel
- Auto Clock Setting
- Auto Tracking
- One Touch Recording
- Unattended (Timer) Recording
- VCR Plus+ programming
- Special Effects Playback: Forward and Reverse Searching; Still; Variable Slow; Frame Advance
- Wireless Remote Control With TV and Cable Converter Box Control Possibility
- Repeat Playback
- Auto Operation Features
- Real Time Counter
- Daylight-Saving Time

Safety Precautions

FCC Warning: Any unauthorized changes or modifications to this equipment void the user's authority to operate it.

This VCR, equipped with a HQ (high quality) system, is compatible with existing VHS (video home system) equipment.

Philips Consumer Electronics Company recommends that you use only video cassette tapes that have been tested and inspected for use in two, four, six and eight hour VCRs, and which are labeled with the **VHS** mark. The use of tapes that have not been inspected for use in two, four, six and eight hour VCRs may result in poor picture quality and excessive deposits on the video heads, which may not be covered by the warranty if damage occurs.

Note to the CATV System Installer: This reminder is provided to call the CATV system installer's attention to Article 820-40 of the National Electrical Code, which provides guidelines for proper grounding – in particular, specifying that the cable ground shall be connected to the grounding system of the building, as close to the point of cable entry as possible.



VCR Plus+ and Plus Code are trademarks of Gemstar Development Corporation. The VCR Plus+ system is manufactured under license from Gemstar Development Corporation.

Copyright 1996 Philips Consumer Electronics Company. All rights reserved.

Welcome to your VCR owner's manual. This manual was designed for you. When looking through it, it will help you to keep several things in mind.

One, this manual is divided into four sections. The *Getting Started* section guides you through the initial setup and simple operations of your VCR. The *Operating Your VCR* section shows you all of the controls of the VCR and remote control and explains on-screen displays. The *Doing More* section guides you through the features of your VCR. Finally, the *Information You May Need* section provides information you may or may not need – other hookups, for example, and trouble checks.

Two, the instructions follow a simple format. Detailed steps explaining operations are on the outside edges of pages. Illustrations accompanied by brief steps explaining operations are on the inside edges of pages. Additional information can be found in boxes labeled NOTES along the lower edges of pages.

Finally, never be afraid to try a feature! **You cannot hurt your VCR by trying any of the features in this manual!**

So read on – and relax.

NOTES

Before doing anything else, record the VCR's model and serial numbers in the spaces provided on page two. These numbers will help us assist you if you ever call for help.

4

Table of Contents

Getting Started

Introduction	3
Table of Contents	4
Before Using Your VCR	5
Hooking Up Your VCR	6
Turning On Your VCR	7
Playing	8
Recording	9
Setting the Clock	10-12

Operating Your VCR

On-Screen Displays	13
Remote Control Buttons	14-15
Display Panel	16-17
Front Panel	18
Rear Panel	19

Doing More

Recording One Channel/Watching Another	20
One Touch Recording	21
Timer Recording	22-23
Rerecording (Tape Duplication)	24
Setting Up VCR Plus+	25-26
Timer Recording With VCR Plus+	27
Channel Memory	28-29
Language/Daylight-Saving Time Selection	30
Playback Options	31-34
Playback Features	35
TV Code Setting	36
Cable Converter Box Code Setting	37

Information You May Need

Specifications/Notes	38-39
Other Hookups	40-43
Before Requesting Service	44-45
Glossary	45
Warranty	46
Index	47
Accessories	48

Before Using Your VCR

Putting Batteries in the Remote Control

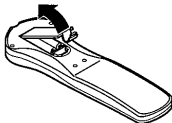

1

To remove the battery compartment lid, push in the tab, then pull up the lid.

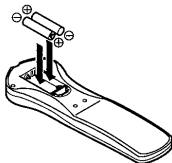

2

Place two AAA batteries inside the battery compartment with their polarities (+ and - ends) aligned as indicated.

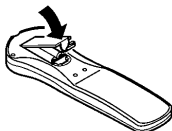

3

Replace the battery compartment lid.

- The remote control and its batteries are supplied.
- Do not mix alkaline and manganese batteries.
- Do not mix old and new batteries.

Using the Remote Control

Point the remote control at the VCR's remote sensor, making sure to stay within the angle shown.

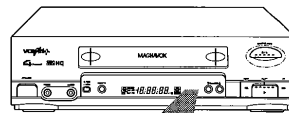

Do not put objects between the remote control and the VCR.

To select channels 100 - 125 using the number buttons, first press the 100 button, then press the last two digits of the desired channel. For example, for channel 117, press the 100 button, 1, 7.

The 100 button will work only when selecting cable channels and when CABLE TV has been selected at the Tuner Setup menu.

See page 28 for details.

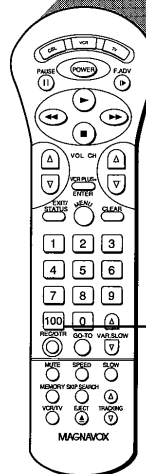

To select channels 1 - 9 using the number buttons, first press 0, then press the desired channel number. For example, for channel 6, press 0, 6.

100 Button

Erase Protection

Video cassette tapes have record tabs to ensure that recordings are not accidentally erased.

1

To prevent accidental erasure, break off the tab with a screwdriver.

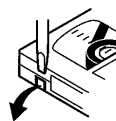

2

To record again, cover the hole with cellophane tape.

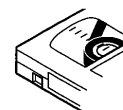

Types of Video Cassette Tapes and Tape Speeds

Tape Speed	Maximum Record/Playback Time			
	Type	T160	T120	T60
SP (Standard Play)		2 hrs. 40 mins.	2 hrs.	1 hr.
LP (Long Play)		5 hrs. 20 mins.	4 hrs.	2 hrs.
SLP (Super Long Play)		8 hrs.	6 hrs.	3 hrs.

NOTES

- In this VCR, use only tapes with the **VHS** mark.
- The chart at the left shows the recording/playback time for three types of video cassettes (T160, T120, T60). There are two recording speeds: SP and SLP. There are three playback speeds: SP, LP, and SLP. During playback, the VCR selects the tape speed automatically. When recording, you can change the speed using the (Tape) SPEED button (see page 15).
- Make sure any light adhesive stick-on notes are removed from the video cassette tape before putting it in the VCR. Removable labels like these can jam the VCR.

6

Hooking Up Your VCR

The basic VCR/TV connection – antenna/cable to VCR to TV – is shown below. For other hookups, including those that use cable converter /descrambler boxes, see pages 40-43.

- 1**
Disconnect the antenna or cable from your TV.

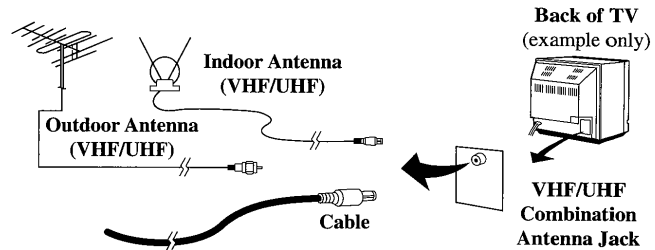

- 2**
Connect the antenna/cable to your VCR.

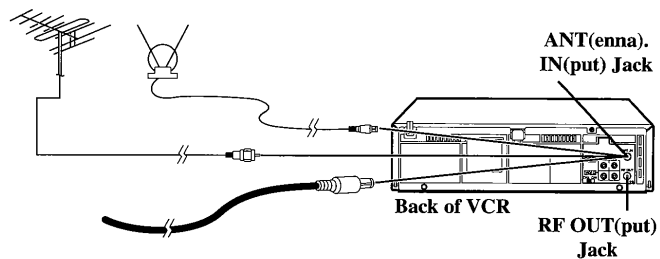

- 3**
Connect your VCR to your TV using the black RF coaxial cable (supplied). Make sure both the TV and the VCR are plugged in.

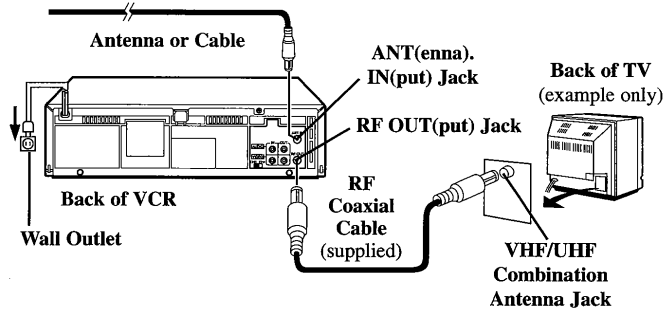

- 4**
Select channel 3 or 4.

Set the CH3/CH4 switch on the back of the VCR to CH3 or CH4, whichever channel is not used or least used in your area. To operate your VCR with your TV, set the TV to the same channel. For example, when playing a tape, if the CH3/CH4 switch is set to CH3, the TV should be on channel 3.

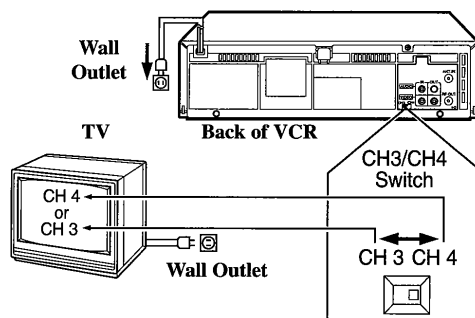

Turning on Your VCR

TV and VCR

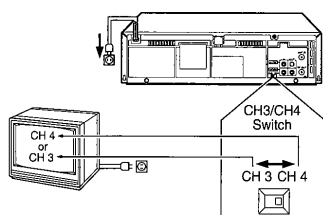

- 1 Set the TV to channel 3 or 4, whichever channel the CH3/CH4 switch on the back of the VCR is set to.

Remote Control

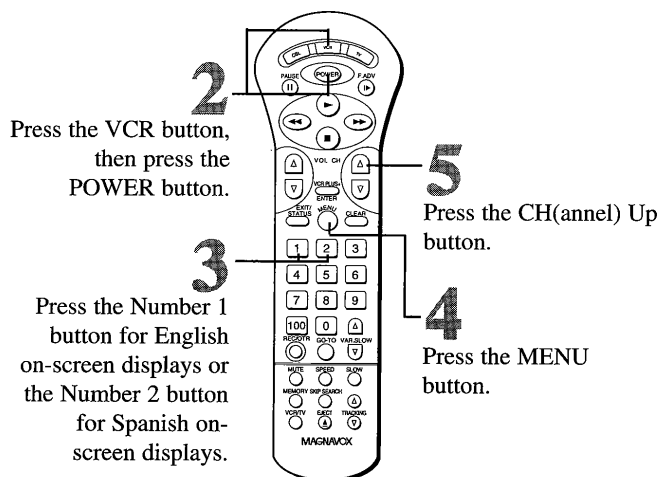

2 Press the VCR button, then press the POWER button.

3 Press the Number 1 button for English on-screen displays or the Number 2 button for Spanish on-screen displays.

5 Press the CH(annel) Up button.

4 Press the MENU button.

Before turning on your VCR, make sure there are batteries in the remote control and the VCR and TV are connected (see pages five and six).

- 1 Turn the TV on. Set it to the same channel as the CH3/CH4 switch on the back of the VCR.

- 2 Press the VCR button, then press the POWER button. The VCR will come on and the language select display screen shown below will appear.

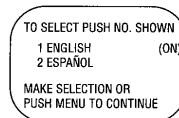

- 3 Press the Number 1 button to select English on-screen displays or the Number 2 button to select Spanish on-screen displays.

- 4 Press the MENU button. The channel program display shown below will appear.

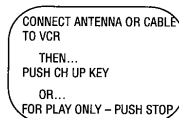

- 5 Press the CH(annel) Up button to begin automatic channel programming. AUTO SET PROCEEDING / PLEASE WAIT will appear on-screen. The VCR will place all of the channels you receive into its memory, so when you scan through channels using the CH(annel) Up/Down buttons, you'll only scan through channels that you receive. When channels are programmed, AUTO SET COMPLETED will appear on-screen briefly. Then the TV will go to the lowest channel programmed.

NOTES

- If you do not see any on-screen displays when you turn on the VCR, repeat the steps under "Hooking Up Your VCR" on page six, then try again. If you still do not see any on-screen displays, follow the steps under "Channel Memory" on page 28 and "Language Selection" on page 30.
- To skip this feature and play a tape immediately, insert a tape with its record tab removed. Playback will start immediately. Or, to skip step 3, press the MENU button. All on-screen displays will be in English. To skip step 5, press the STOP button. Channels will not be programmed.
- To program channels or change the language at a later time, follow the steps on pages 28 and 30.
- If you try to program channels when there is no antenna or cable connected to the VCR, AUTO SET PROCEEDING / PLEASE WAIT will appear on-screen for a few moments. Then, NO TV SIGNALS will appear on-screen. Connect an antenna or cable to the VCR and try again. You may need to follow the steps on page 28.
- You cannot program channels if a cable converter box is connected to the VCR, which is connected to a TV. If you have this kind of connection, see page 40-43 for details.
- The instructions on this page only work when you turn on the VCR for the first time.

8 Playing

Read and follow the steps below to play a tape.

1

Turn the TV on and set it to channel 3 or 4, whichever the CH3/CH4 switch on the back of the VCR is set to.

2

Insert a tape in the VCR. The power will come on. The VCR will place itself in VCR position automatically (the VCR light on the display panel of the VCR will appear). If the VCR light does not appear, press the VCR/TV button once. If the tape's record tab has been removed, playback will start automatically.

3

If playback does not start automatically, press the PLAY button to start playback. PLAY will appear on the display panel of the VCR.

4

Press the STOP button on the remote control or the STOP/EJECT button on the VCR once to stop playback.

5

Press the REWIND/SEARCH button to rewind the tape.

6

Press the EJECT button on the remote control or the STOP/EJECT button on the VCR again to remove the tape.

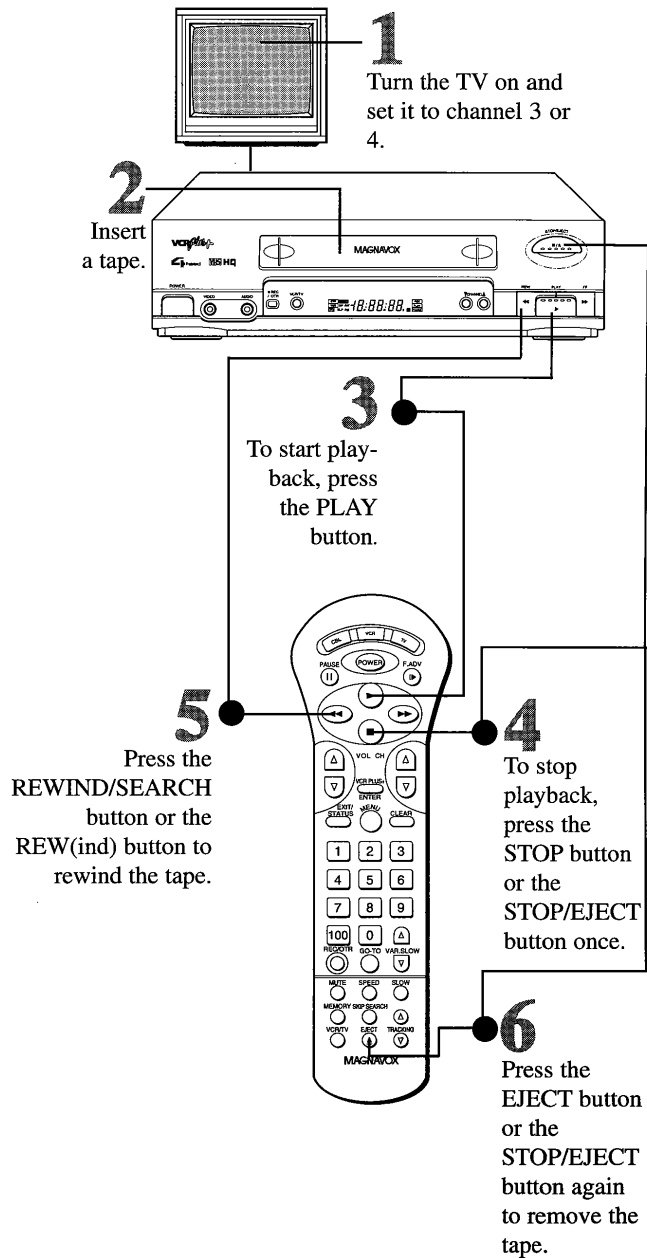

• Playback options and features – slow motion playback, for example – are discussed on pages 31 - 35.

Recording

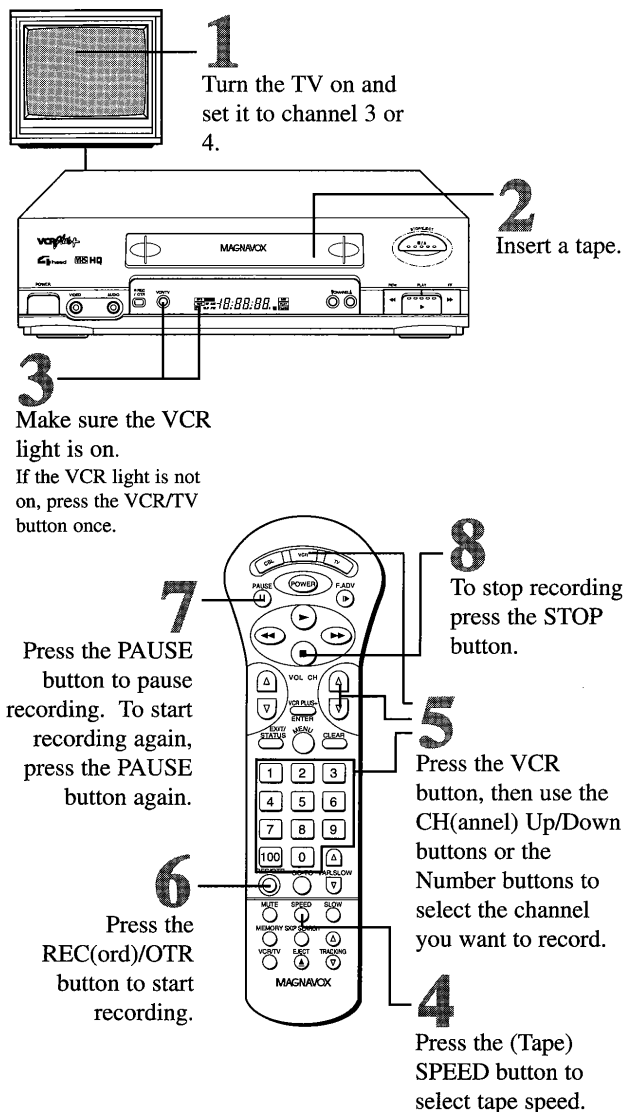

Read and follow the steps below to record a television program.

1

Turn the TV on and set it to channel 3 or 4, whichever the CH3/CH4 switch on the back of the VCR is set to.

2

Insert a tape with its record tab intact (see page five) in the VCR. The power will come on.

3

If the VCR light on the display panel of the VCR comes on, go to step 4. If the VCR light does not come on, press the VCR/TV button once.

4

Press the (Tape) SPEED button on the remote control until the desired tape speed (see page five) appears on the TV screen.

5

Press the VCR button, then use the CH(annel) Up/Down buttons or the Number buttons to select the channel to be recorded.

6

Press the REC(ord)/OTR button to start recording.

7

To pause the recording (for example, during commercials), press the PAUSE button. To start recording again, press the PAUSE button again.

8

To stop recording, press the STOP button.

NOTES

- If the REC(ord)/OTR button is pressed while a tape without a record tab is in the VCR, PROTECTED CASSETTE CANNOT RECORD will appear on-screen, then the VCR will eject the tape.
- If the REC(ord)/OTR button is pressed while no cassette is in the VCR, NO CASSETTE will appear on-screen.
- You can change the tape speed while the VCR is recording, but some distortion will appear on the tape.
- Press the EXIT/STATUS button to see the tape counter (see pages 13 and 32).
- Recording options are on pages 20 - 27.

10

Setting the Clock

Before you begin, make sure:

- The VCR is on and in VCR position (see pages 15, 16 and 18).
- You make each entry within 10 seconds of the previous entry (otherwise, the VCR will exit Set Clock mode and you will have to start over).
- You have correctly chosen TV or CABLE TV at the TUNER SET UP menu.

When the power plug is connected to an AC outlet, the correct time will appear on the display panel of the VCR (when the power is Off).

- When -- : -- appears on the display panel, you can not use the AUTO CLOCK feature. You must set the clock manually (see page 12).
- To change an incorrect time, follow the steps under Time Zone Selection or PBS Channel Selection (see page 11).

During AUTO CLOCK SETTING, the display panel shows as below:

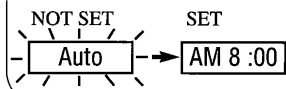

Time Zone Selection

1

Press the MENU button to bring up the main menu display.

TO SELECT PUSH NO. SHOWN
1 PROGRAM
2 VCR SET UP
3 TUNER SET UP
4 INPUT SELECT
5 SET CLOCK
TO END PUSH EXIT

2

Press the Number 5 button to select SET CLOCK. (IF AUTO CLOCK is set to OFF, SET TIME ZONE will not be available in the menu. Follow the steps under PBS Channel Selection to select AUTO CLOCK, then start again at step 1.)

SET CLOCK
1 AUTO CLOCK (ON)
2 DAYLIGHT SAV TIME (ON)
3 SET MANUAL CLOCK (OFF)
4 SET TIME ZONE (AUTO)
TO SELECT PUSH NO. SHOWN
TO END PUSH EXIT

3

Press the Number 4 button to select SET TIME ZONE.

TO SELECT PUSH NO. SHOWN
1 AUTO (ON)
2 ATLANTIC
3 EASTERN
4 CENTRAL
5 MOUNTAIN
6 PACIFIC
7 ALASKA
8 HAWAII
PUSH MENU TO CONTINUE

4

Use the Number buttons to select your TIME ZONE. If you live near the boundary of an adjacent time zone, or if you receive cable TV channels, your PBS channel may come from a different time zone. In this case, select the correct time zone manually.

5

Press the MENU button, then press the EXIT/STATUS button. Press the POWER button to turn off the VCR. Make sure that the VCR is off until the next hour so that the clock can be set. (The clock is automatically adjusted on the hour except at 11:00 PM, midnight, 1:00 AM and 2:00 AM.)

Remote Control

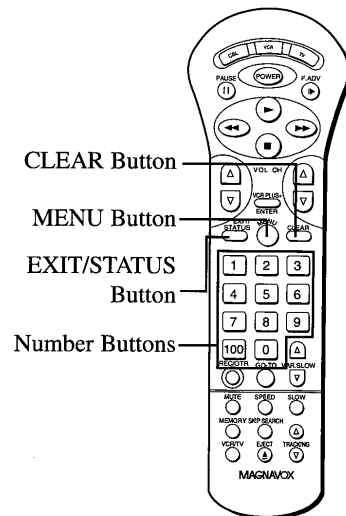

Setting the Clock (cont'd)

Remote Control

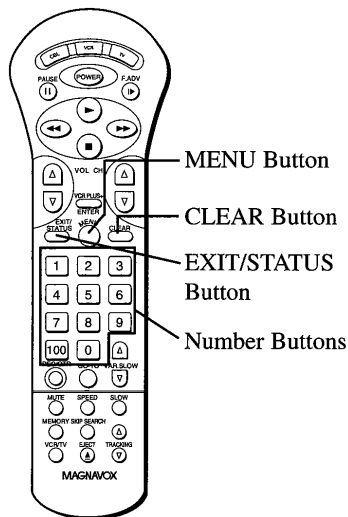

PBS Channel Selection

1

Press the MENU button to bring up the main menu display.

TO SELECT PUSH NO. SHOWN
 1 PROGRAM
 2 VCR SET UP
 3 TUNER SET UP
 4 INPUT SELECT
 5 SET CLOCK
 TO END PUSH EXIT

2

Press the Number 5 button to select SET CLOCK.

SET CLOCK
 1 AUTO CLOCK (ON)
 2 DAYLIGHT SAV TIME (ON)
 3 SET MANUAL CLOCK (OFF)
 4 SET TIME ZONE (AUTO)
 TO SELECT PUSH NO. SHOWN
 TO END PUSH EXIT

3

If (ON) appears to the right of AUTO CLOCK, press the Number 1 button twice. If (OFF) appears to the right of AUTO CLOCK, press the Number 1 button once.

AUTO CLOCK
 AUTO CLOCK USES
 PBS CHANNEL DATA
 1 SET PBS CH. AUTO
 2 SET PBS CH. MANUAL
 TO SELECT PUSH NO. SHOWN
 TO END PUSH EXIT

4

- To tell the VCR the PBS channel from which to take the time, press the Number 2 button to select SET PBS CH. MANUAL. Use the Number buttons to enter your PBS channel number. (If you make a mistake, press the CLEAR button.) Press the EXIT/STATUS button. You will be prompted to turn off the VCR. Press the EXIT/STATUS button, then go to step 5.
- To have the VCR find the PBS channel from which to take the time, press the Number 1 button to select SET PBS CH. AUTO. You will be prompted to turn off the VCR. Press the EXIT/STATUS button, then go to step 5.

SET AUTO CLOCK(PBS)CH
 CH 12
 TO CORRECT PUSH CLEAR
 TO END PUSH EXIT

5

Press the POWER button to turn off the VCR. Make sure that the VCR is off until the next hour so that the clock can be set. (The clock is automatically adjusted on the hour except at 11:00 PM, midnight, 1:00 AM and 2:00 AM.)

12

Setting the Clock (cont'd)

Follow the steps below to manually set your VCR's clock. Make sure:

- The VCR is on and in VCR position (see pages 15, 16 and 18).
- You make each entry within 10 seconds of the previous entry (otherwise, the VCR will exit Set Clock mode and you will have to start over).
- You have correctly chosen TV or CABLE TV at the TUNER SET UP menu.

1

Press the MENU button to bring up the main menu display.

TO SELECT PUSH NO. SHOWN
1 PROGRAM
2 VCR SET UP
3 TUNER SET UP
4 INPUT SELECT
5 SET CLOCK
TO END PUSH EXIT

2

Press the Number 5 button to select SET CLOCK.

SET CLOCK
1 AUTO CLOCK (ON)
2 DAYLIGHT SAV TIME (ON)
3 SET MANUAL CLOCK (OFF)
4 SET TIME ZONE (AUTO)
TO SELECT PUSH NO. SHOWN
TO END PUSH EXIT

3

Press the Number 3 button to select SET MANUAL CLOCK.

TIME ----
TO END PUSH EXIT

4

Within 10 seconds, press two Number buttons for the hour and two Number buttons for the minute(s). Then press 1 for AM or 2 for PM. For example, for 2:15 PM, press 02, 15, 2.

- Enter a 0 before single digit numbers.
- Entries that do not match the VCR's internal calendar will cause a question mark (?) to appear on-screen.
- To make corrections, press the CLEAR button until the space for the number you want to correct is flashing. Then enter the correct number.

TIME 02:15 PM
MONTH --/--
TO CORRECT PUSH CLEAR
TO END PUSH EXIT

5

Press two Number buttons for the month, two Number buttons for the day, and two Number buttons for the year. For example, for July 1, 1996, press 07, 01, 96. The day of the week will appear automatically.

TIME 02:15 PM
DATE 07/01/96
MON.
TO CORRECT PUSH CLEAR
TO END PUSH EXIT

6

Press the EXIT/STATUS button to start the clock. The screen will return to the program you were watching.

Remote Control

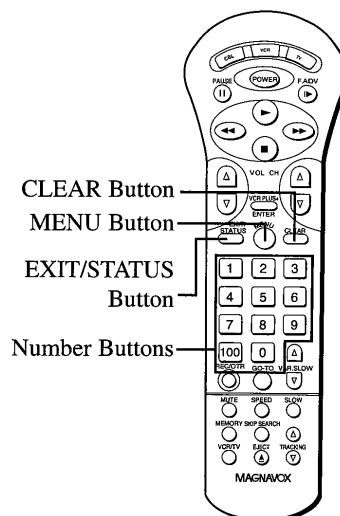

NOTES

- To reset the clock, follow the steps above.
- To display the time, press the EXIT/STATUS button. A status display, which includes the time, will appear on the TV screen. For details, see "VCR Status Display" on page 13.
- Power failures can cause you to lose your clock setting as well as programmed channels. If this happens, follow the steps on pages 7 and 10 - 12.
- If the numbers entered do not match the VCR's internal calendar, the entry will be rejected and a question mark (?) will appear on-screen.
- If you press the EXIT/STATUS button while you are setting the clock, the TV screen will return to the program you were watching. If this happens, start over.
- To program the VCR so its clock will automatically move forward one hour in April and turn back one hour in October, follow the steps under Daylight-Saving Time selection on page 30.

13

On-Screen Displays

VCR Status Display Screen

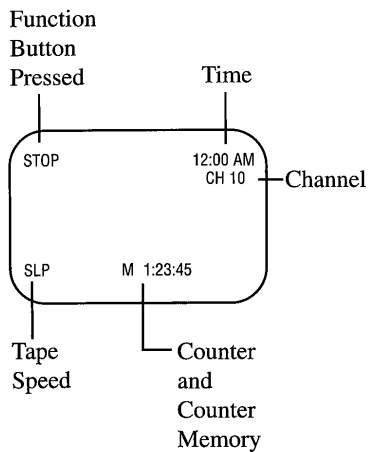

VCR Status Display

A status display, which includes the current time, channel, and other information (see illustration of the status display at left), will appear when you press the EXIT/STATUS button or certain function buttons. The contents of the Status Display may vary.

ON SCREEN ON:

- Whenever you press the PLAY button or the STOP button, some of the contents of the Status Display will appear for five seconds.

COUNTER ONLY:

- The tape counter will appear on-screen at all times. Whenever you press the PLAY button or the STOP button, some of the contents of the Status Display will appear for five seconds. After five seconds, only the counter will remain on the screen.

ON SCREEN OFF:

- No Status Display will appear when you press function buttons or the EXIT/STATUS button.

To select one of the status display modes, follow the steps below.

1

Press the MENU button to bring up the main menu display.

2

Press the Number 2 button to select VCR SET UP.

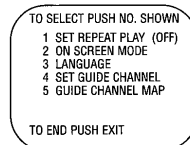

3

Press the Number 2 button to select ON SCREEN MODE.

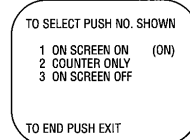

4

Press the Number 1 button to select ON SCREEN ON, the Number 2 button to select COUNTER ONLY, or the Number 3 button to select ON SCREEN OFF. ON will appear beside the selected status display mode.

5

Press the EXIT/STATUS button to exit.

NOTES

- In On Screen On and Counter Only modes:**
 - You may bring up the status display at any time by pressing the EXIT/STATUS button.
 - Channel numbers (when tuned) will be displayed for a few seconds.
 - If the channel you select has no broadcast, the screen will become a solid blue field. The screen will remain blue until you select an active channel.
 - Press the EXIT/STATUS button at any time to change the display on the display panel to show the time, counter information, or channel number.

14

Remote Control Buttons

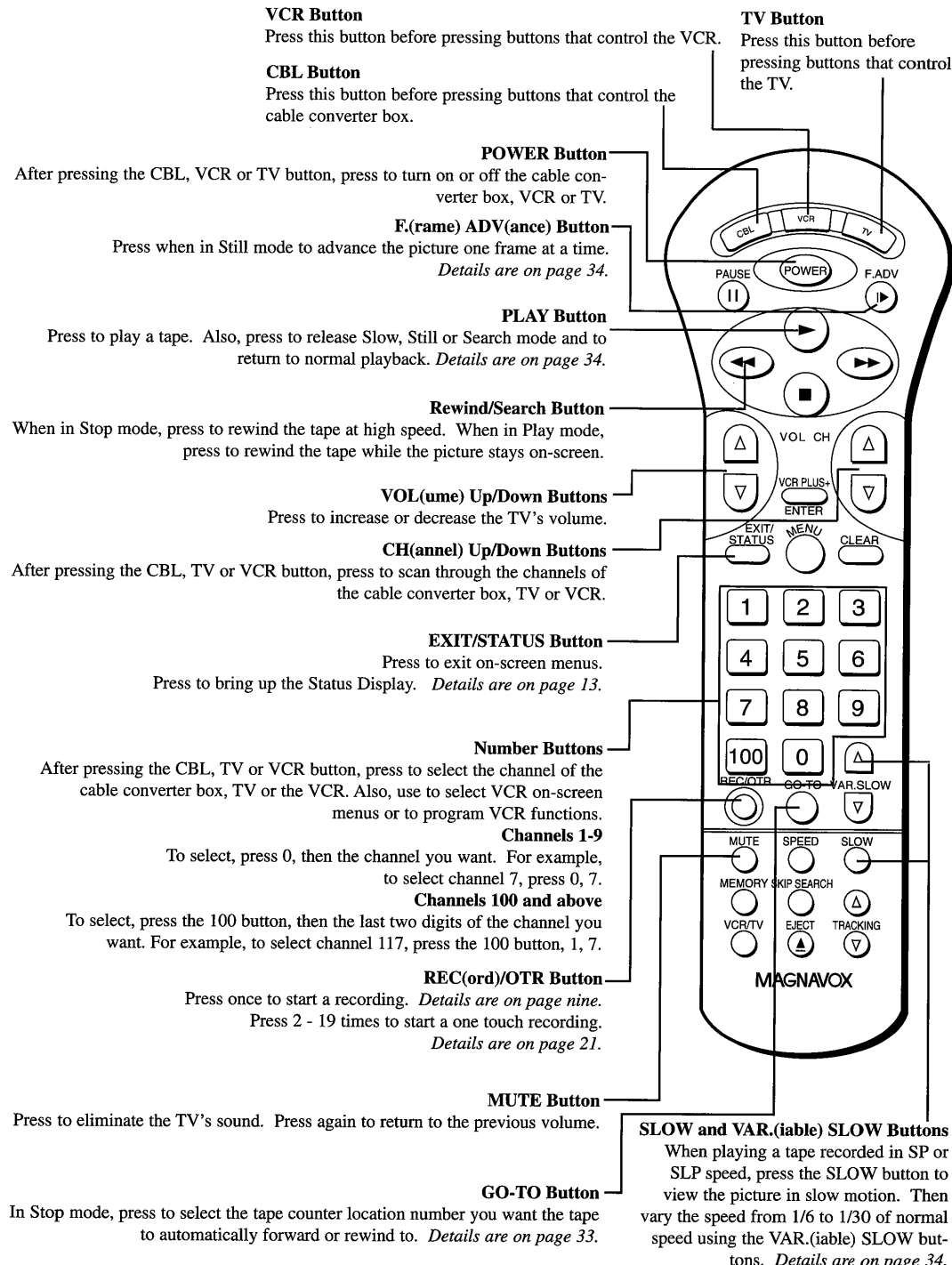

Remote Control Buttons (cont'd)

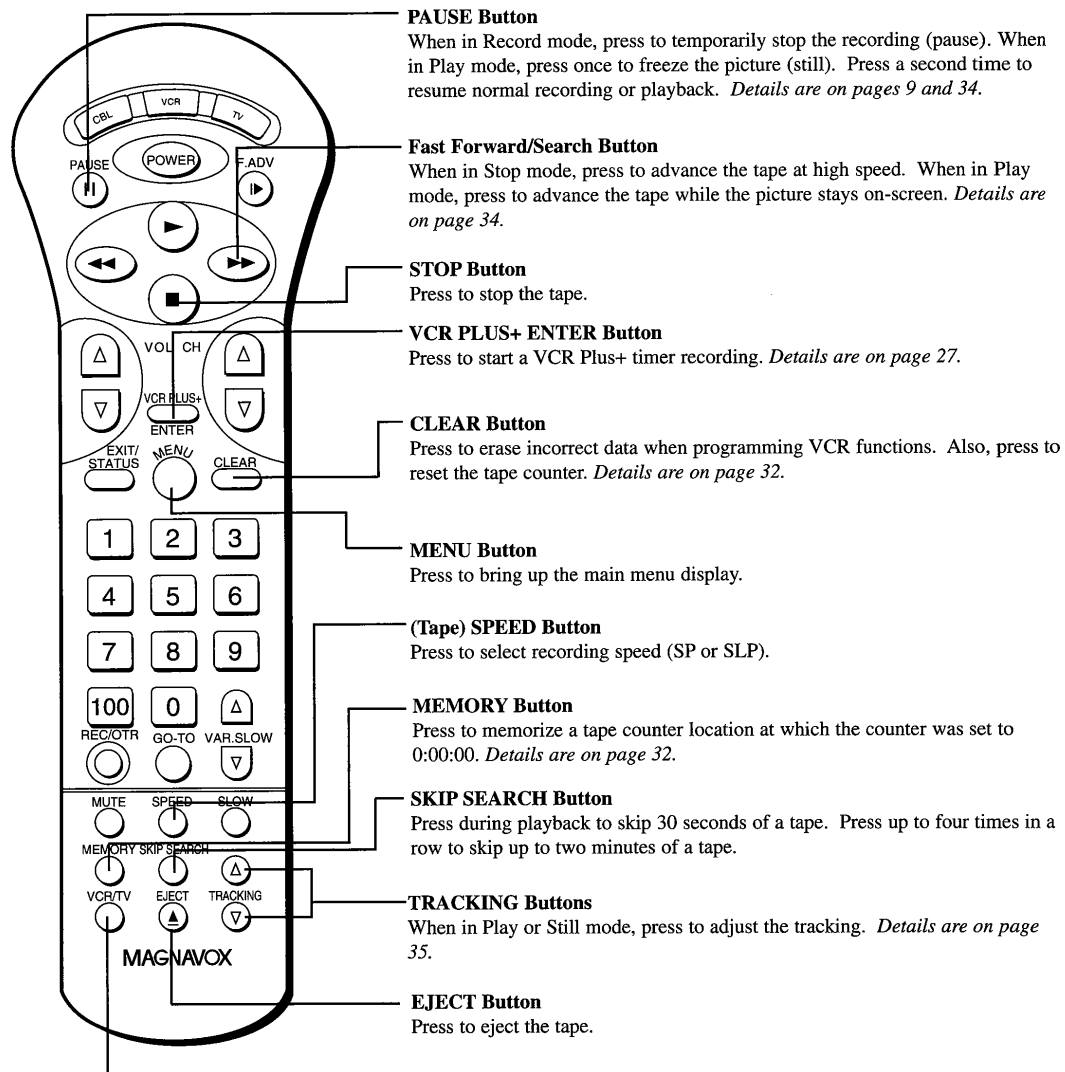

VCR/TV Button

Use to select the signal that your TV receives.

● VCR Position

Use to watch a tape, to watch a program while recording it, or to watch a TV broadcast using the CH(annel) Up/Down or Number buttons.

● TV Position

Use to watch TV or to watch one program while recording another. *Details are on page 20.*

NOTES

This remote control may or may not operate your TV or cable converter box. See "TV Code Setting" on page 36 and "Cable Converter Box Code Setting" on page 37.

16

Display Panel

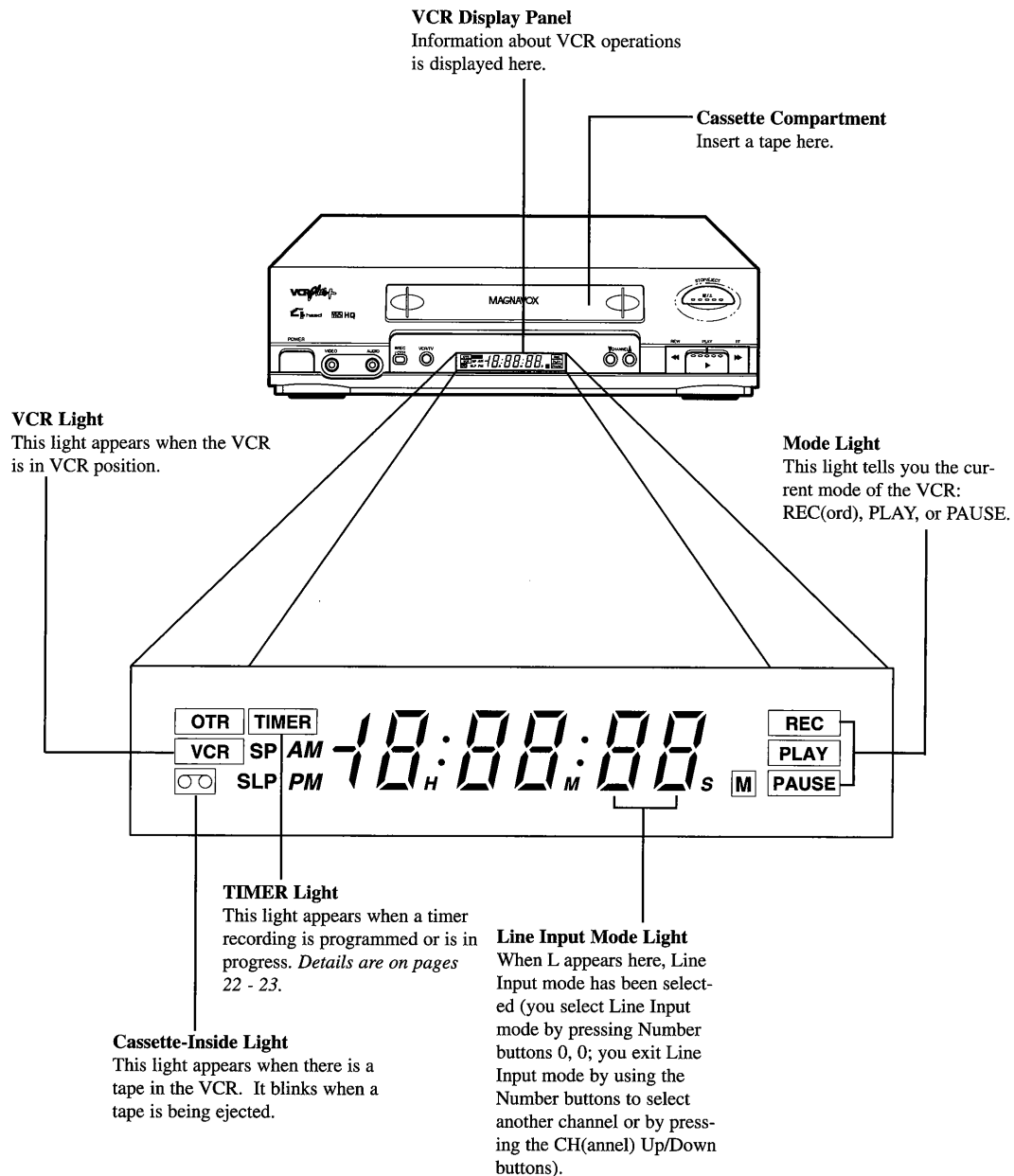

Display Panel (cont'd)

OTR Light

This light flashes when a one touch recording is in progress. Details are on page 21.

Wireless Remote Sensor

Receives an infrared signal from your remote control so you can operate your VCR from a distance.

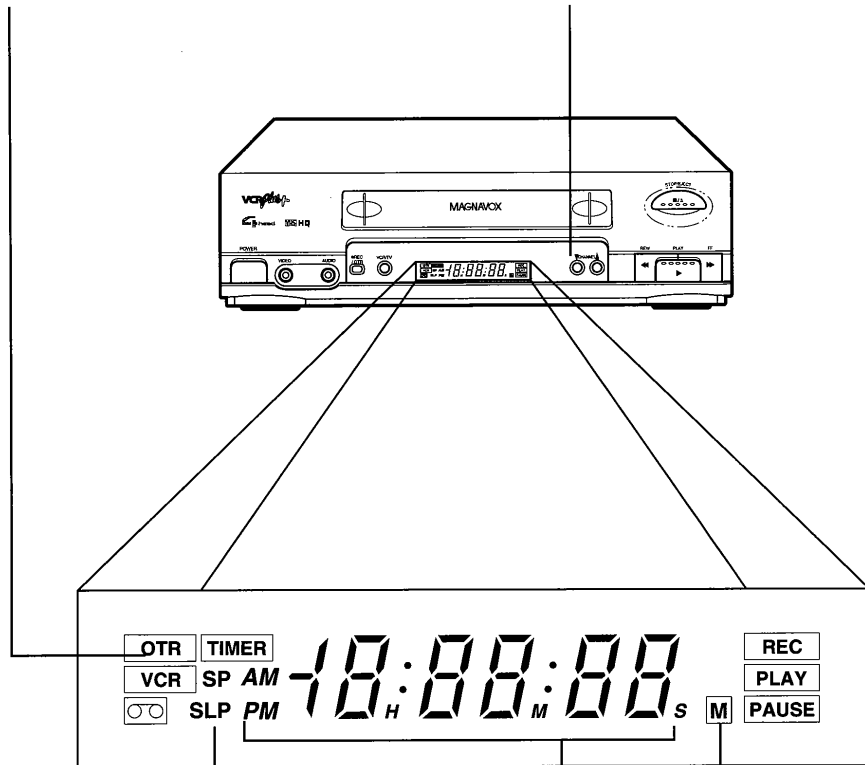

Tape Speed Light

This light displays the tape speed during recording and playback. *NOTE: Although this VCR will play tapes recorded in LP speed, LP will not appear on the display panel.*

Memory Light

This light appears when a tape location has been memorized. Details are on page 32.

Clock/Counter/Channel Display

Each time you press the EXIT/STATUS button on the remote control, the VCR display panel will change. It will rotate between the following three displays: the current time (when the clock is set); the tape counter; and the channel number.

18

Front Panel

FF (Fast Forward) Button

When in Stop mode, press to fast forward the tape at high speed. When in Play mode, press to fast forward the tape while the picture stays on-screen. *Details are on page 34.*

PLAY Button

Press to play a tape. Also, press to release Slow, Still or Search mode and return to normal playback (*see page 34 for details*).

STOP/EJECT Button

Press once to stop the tape. Press again to eject the tape.

POWER Button

Press to turn the VCR power on and off.

REW (ind) Button

When in Stop mode, press to rewind the tape at high speed. When in Play mode, press to rewind the tape while the picture stays on-screen. *Details are on page 34.*

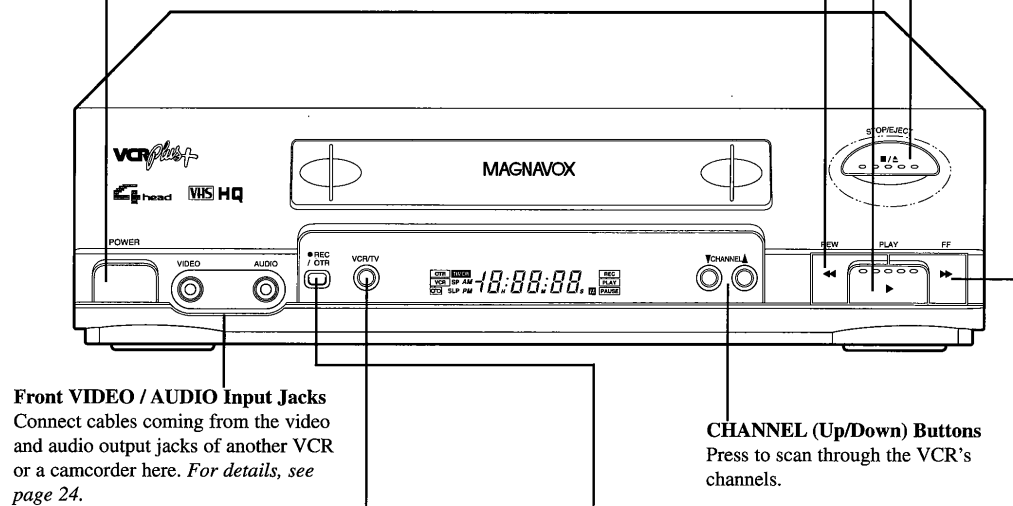

Front VIDEO / AUDIO Input Jacks

Connect cables coming from the video and audio output jacks of another VCR or a camcorder here. *For details, see page 24.*

CHANNEL (Up/Down) Buttons

Press to scan through the VCR's channels.

VCR/TV Button

Use to select the signal that your TV receives.

● VCR Position

Use to watch a tape, to watch a program while recording it, or to watch a TV broadcast using the CH(annel) Up/Down or Number buttons.

● TV Position

Use to watch TV or to watch one program while recording another.

REC(ord)/OTR Button

Press once to record. Press 2 - 19 times to start a One Touch Recording 30 minutes to nine hours long. (*See page 21 for details.*)

19

Rear Panel

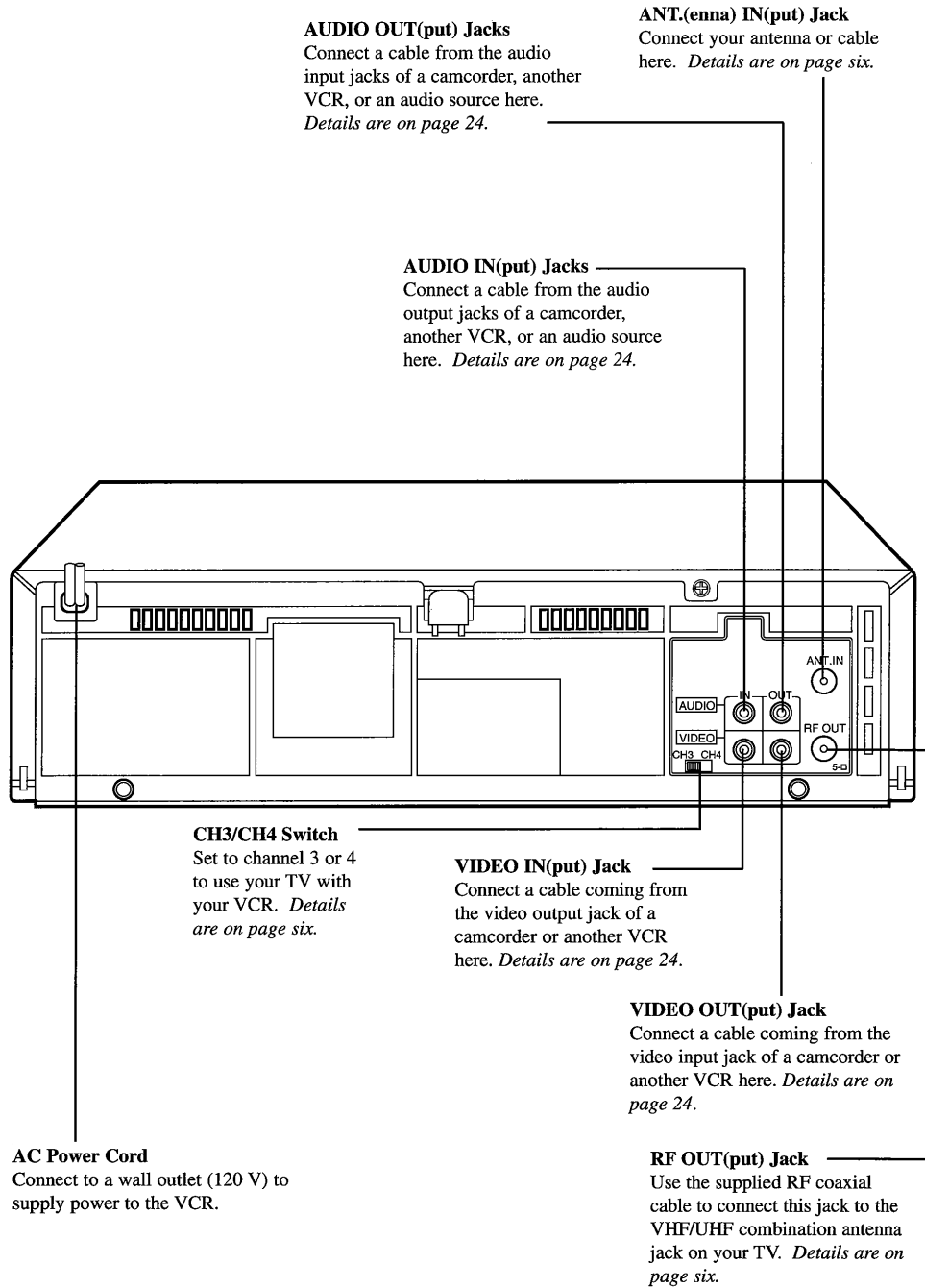

Recording One Channel/Watching Another

1

Start a recording (see page nine).

2

Press the VCR/TV button to put the VCR in TV position. The VCR light will disappear from the display panel.

3

Use the TV remote control or the TV controls to select the channel you want to watch. The channel selected with the TV controls will appear on-screen while the channel you previously selected to record is being recorded.

4

To return to the channel being recorded, use the TV remote control or the TV controls to select channel 3 or 4 (see page six for details). Press the VCR button. Then press the VCR/TV button to put the VCR in VCR position. The channel being recorded will appear on-screen.



3

Select the channel you want to watch.

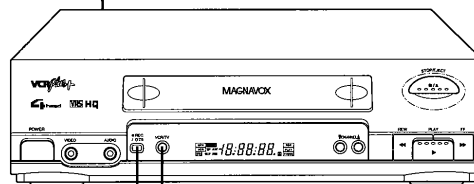

1

Start a recording.

4

To return to the channel being recorded, select channel 3 or 4 at the TV. Press the VCR button. Then press the VCR/TV button to put the VCR in VCR position.

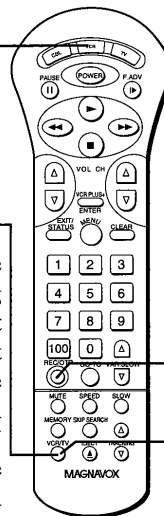

Remote Control

2

Put the VCR in TV position.

NOTES

- If you use a cable converter box or satellite system hookup, you may not be able to watch one channel while recording another. See pages 40 - 43 for details.
- If your VCR remote control operates your TV, press the TV button, then use the CH(annel) Up/Down buttons or the Number buttons on the VCR remote control to select TV channels. See page 36 for details.
- If you don't receive channels, repeat the steps on page six, then follow the instructions above carefully.

One Touch Recording

Remote Control

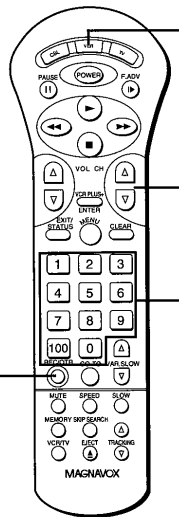

2 Press the REC(ord)/OTR button 2 - 19 times to select a recording length and start an OTR.

1 Press the VCR button, then use the CH(annel) Up/Down buttons or the Number buttons to select the channel you want to record.

The one touch recording (OTR) function allows you to program an immediate timed recording 30 minutes to nine hours long without setting the timer. Before you begin, make sure:

- Channels have been programmed.
- The desired recording speed (SP or SLP) has been selected with the (Tape) SPEED button.
- There is a tape in the VCR. Make sure the tape's record tab is intact and the tape is long enough to record the program(s).
- The VCR is in VCR position.

Starting an OTR

1

Press the VCR button, then use the CH(annel) Up/Down buttons or the Number buttons to select the channel you want to record.

2

Press the REC(ord)/OTR button 2 - 19 times, until the desired recording length (30 minutes to nine hours) appears in the upper left corner of the screen and on the display panel briefly. OTR will flash on the display panel of the VCR and REC will appear on the display panel.

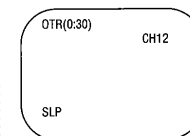

Stopping an OTR

To stop an OTR before recording is finished, press the STOP button. To cancel the OTR but continue recording, press the REC(ord)/OTR button until OTR changes to REC on-screen. REC will remain on the display panel.

NOTES

- To check the time remaining for an OTR after the OTR has been set, press the EXIT/STATUS button.
- To change the recording length while an OTR is in progress, press the REC(ord)/OTR button until the desired length is displayed on-screen.
- If the preset time for a timer recording comes up during an OTR, the OTR has priority.

Timer Recording

Follow the steps below to program your VCR to record TV programs while you're away from home. You can program up to eight timer recordings. For each one, the VCR will turn itself on, record, and turn itself off automatically. Before you begin make sure:

- Channels have been programmed.
- The clock has been set.
- There is a tape in the VCR. Make sure the tape's record tab is intact and the tape is long enough to record the program(s).
- The VCR is in VCR position.

You must do each step within 60 seconds of completing the previous step. If you don't, you will have to start again at step 1.

1

Press the MENU button to bring up the main menu display.

TO SELECT PUSH NO. SHOWN
 1 PROGRAM
 2 VCR SET UP
 3 TUNER SET UP
 4 INPUT SELECT
 5 SET CLOCK
 TO END PUSH EXIT

2

Press the Number 1 button on the remote control to select PROGRAM.

TO SELECT PUSH NO. SHOWN
 1 ONCE
 2 DAILY
 3 WEEKLY
 4 PROGRAM REVIEW
 TO END PUSH EXIT

3

Select a once, daily or weekly recording.

- Press the Number 1 button to select ONCE. The VCR will record a TV program on any day you choose, up to 12 months away.
- Press the Number 2 button to select DAILY. The VCR will record every Monday through Friday, starting at the same time and recording for the same length of time.
- Press the Number 3 button to select WEEKLY. The VCR will record on the same day, at the same time, and for the same length of time every week.

DAILY PROGRAM (MON-FRI)
 PROGRAM - 12345678 -

SELECT PROGRAM NUMBER
 TO END PUSH EXIT

**Daily
 Recording
 Menu
 Screen**

4

Use the Number buttons (1 - 8) to select a position in which to store the timer recording. Flashing numbers indicate an open position (one in which a timer recording has not yet been stored).

NOTE: If you select a number that has already been used to store a timer recording, PREVIOUSLY SET PROGRAM will appear on-screen for a few seconds. Then information about the program in that position will be displayed on-screen. If this happens, press the EXIT/STATUS button twice. Then start again at step 1.

5

- If you are using a standard antenna to VCR to TV hookup, enter the channel of the TV program you want to record.
- If you are recording from line input, press 0, 0. A/V IN will appear on-screen.
- If you are recording using a cable converter box, see pages 40 - 43.

ONE TIME PROGRAM
 PROGRAM 1
 CHANNEL --
 TO CORRECT PUSH CLEAR
 TO END PUSH EXIT

6

Press two Number buttons for the hour you want the recording to begin. Press two number buttons for the minute(s) you want the recording to begin. Press 1 for AM or 2 for PM. For example, for 9:30 PM, press 09, 30, 2.

ONE TIME PROGRAM
 PROGRAM 1
 CHANNEL 10
 TIME ON ---:---
 TO CORRECT PUSH CLEAR
 TO END PUSH EXIT

7

Follow the instructions in step 6 to set the recording's stop time.

ONE TIME PROGRAM
 PROGRAM 1
 CHANNEL 10
 TIME ON 09:30 PM
 TIME OFF ---:---
 TO CORRECT PUSH CLEAR
 TO END PUSH EXIT

Checking or Clearing Timer Recordings

1. With the VCR on and in VCR position, press the MENU button.
2. Press the Number 1 button to select PROGRAM.
3. Press the Number 4 button to select PROGRAM REVIEW. The timer recording information for the program with the lowest numbered position will appear on-screen.

4. Press the Number 1 button repeatedly to review all programmed timer recordings. If you don't press the Number 1 button in 10 seconds, the VCR will automatically display

- information about the next programmed timer recording. This will continue until all filled positions have been displayed. Then the previous on-screen menu will appear.
5. To cancel the timer recording displayed, press the CLEAR button. You will return to the previous menu. Press the EXIT/STATUS button to exit.
 6. Repeat steps 1 - 5 to make sure you have cleared the correct timer recording.

Timer Recording (cont'd)

8

Press 1 to record in SP speed. Press 2 to record in SLP speed. You cannot use the (Tape) SPEED button at this time.

ONE TIME PROGRAM
PROGRAM 1
CHANNEL 10
TIME ON 09:30 PM
TIME OFF 11:00 PM
REC SPEED SLP
SP=1 SLP=2
TO CORRECT PUSH CLEAR
TO END PUSH EXIT

9

Press two Number buttons for the month and the day you want the program to record. For example, for July 10, press 07, 10. The day of the week and the year will be displayed automatically (you cannot program the VCR to record more than one year in advance).

ONE TIME PROGRAM
PROGRAM 1
CHANNEL 10
TIME ON 09:30 PM
TIME OFF 11:00 PM
REC SPEED SLP
START DATE 07/10/96
WED.
TO CORRECT PUSH CLEAR
TO END PUSH EXIT

10

Press the EXIT / STATUS button. PROGRAM WAS COMPLETED / PLEASE TURN OFF VCR FOR TIMER RECORDING will appear on-screen (if PROGRAM NOT COMPLETED appears, try again from step 1). In three seconds the on-screen display will disappear. Now, go to steps 11 and 12.

Making Corrections

1. While the screen you want to change is displayed, press the CLEAR button until the cursor is flashing on the item you want to change. Then enter the correct information.
2. Continue to do this until all information is correct.

11

If you want to program another timer recording, repeat steps 1 - 10. If you don't want to program another timer recording, go to step 12.

12

Turn off the VCR power. The TIMER light will come on. The VCR must be turned off for a timer recording to take place. If you forget to turn the VCR off, PLEASE TURN OFF VCR FOR TIMER RECORDING flashes on your TV screen two minutes before a timer recording starts. You can remove it by pressing the CLEAR button.

**The VCR
must be off for a
timer recording
to take place!
Make sure there
is a tape in the
VCR.**

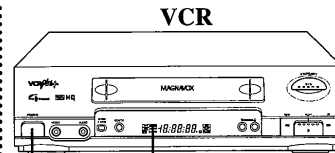

POWER Button
TIMER Light

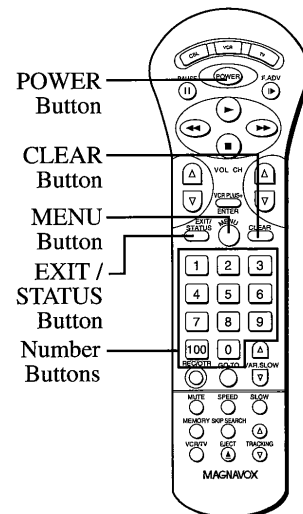

Remote Control

NOTES

- If you leave the VCR on past the scheduled start time of a timer recording, you will **not** be prompted by the VCR again to turn the VCR off. When you turn the VCR off, the timer recording will **not** take place.
- If the preset time for a timer recording comes up during an OTR, the OTR has priority.
- To stop a started timer recording, press the POWER button on the VCR or the remote control.
- The VCR will turn itself off automatically after a timer recording has finished.

Please see page 38 for more notes.

Rerecording (Tape Duplication)

The instructions on this page show you how to copy tapes. The illustration uses two VCRs just like yours. Different VCRs may operate differently. *NOTE: Unauthorized recording of copyrighted television programs, video tapes, or other materials may infringe on the rights of copyright owners and violate copyright laws.*

1

VCR 1 will play your tape. Insert a prerecorded tape in VCR 1. If the tape does not have a record tab, playback begins. If this happens, press the STOP/EJECT button on VCR 1.

2

VCR 2 will record your tape. Insert a blank tape in VCR 2. Make sure the VCR power is on and the VCR is in VCR position.

3

Turn the TV on and put it on channel 3 or 4, whichever channel the CH3/CH4 switch on VCR 2 is set to (see page six).

4

Point the remote control at VCR 2. Press the VCR button, then press the Number buttons 0, 0. L will appear on the display panel.

5

Point the remote control at VCR 2. Use the (Tape) SPEED button to select SP or SLP.

6

Press the PLAY button on VCR 1 and the REC(ord)/OTR button on VCR 2 **at the same time**.

NOTES

If connections are made at the front AUDIO and VIDEO jacks, they will automatically have priority over the rear AUDIO and VIDEO IN(put) jacks. Disconnect the cables from the front AUDIO and VIDEO jacks before recording using the rear AUDIO and VIDEO IN(put) jacks.

Connections

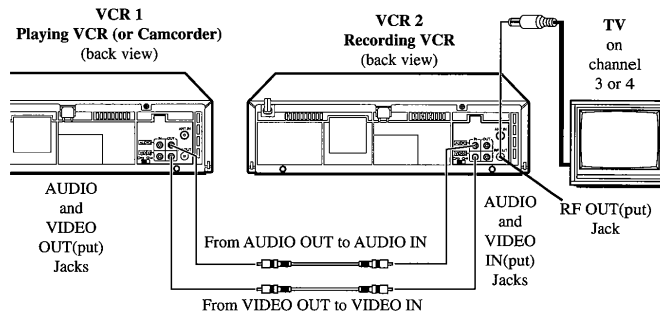

- You can also connect audio and video cables to the AUDIO and VIDEO input jacks on the front of VCR 2.
- Audio and video cables are not included.

Operation

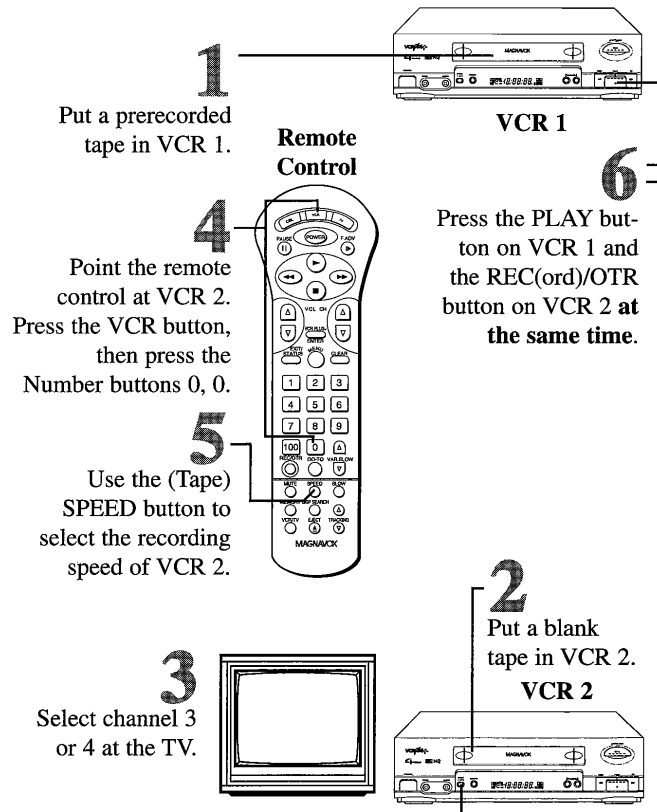

Setting Up VCR Plus+

VCR Plus+ allows you to program timer recordings. When you enter a program's VCR Plus+ number (found in your TV guide), the VCR automatically records that program. Follow the steps below to set up VCR Plus+.

1 First, fill in the boxes on this page. It will only take a few minutes, and you must do it if you want VCR Plus+ to work properly.

Since the channel numbers of the stations you receive may not be the same as the station numbers, and since channel numbers differ from area to area, you must program the VCR with your local channel information. To fill in the boxes, you will need 1) a cable channel line-up list, if applicable (you can request one from your cable company), and 2) a chart that lists VCR Plus+ guide channel numbers, which you can find in your TV guide or the TV listings of your local newspaper.

TV Channels		
Local TV Stations (call letters)	VCR Plus+ Guide Channel Number (GUIDE CH.)	Local Channel Number (USER CH.)

Cable Channels		
Cable Stations (call letters)	VCR Plus+ Guide Channel Number (GUIDE CH.)	Cable Channel Number (USER CH.)

Setting Up VCR Plus+ (cont'd)

2

Now, compare the channel numbers you have written into the GUIDE CH. and USER CH. columns. You'll notice that some stations have guide and user channel numbers that are the same, and other stations have channel numbers that do not match. Where the channel numbers DO NOT match, you must tell the VCR the guide and user channel numbers according to the following steps.

3

Press the VCR button, then press the MENU button. Finally, press the Number 2 button to select VCR SET UP.

TO SELECT PUSH NO. SHOWN

- 1 PROGRAM
- 2 VCR SET UP
- 3 TUNER SET UP
- 4 INPUT SELECT
- 5 SET CLOCK

TO END PUSH EXIT

4

Press the Number 4 button to select SET GUIDE CHANNEL.

TO SELECT PUSH NO. SHOWN

- 1 SET REPEAT PLAY (OFF)
- 2 ON SCREEN MODE
- 3 LANGUAGE
- 4 SET GUIDE CHANNEL
- 5 GUIDE CHANNEL MAP

TO END PUSH EXIT

5

Look at the boxes you filled in on page 25. For stations whose guide channels and user channels are not the same, press two Number buttons for the guide channel and two Number buttons for the user channel.

SET GUIDE CHANNEL

SELECT GUIDE CH. NO.

 GUIDE CH. 
 USER CH. 

TO END PUSH EXIT

6

Press the Number 1 button so your VCR will memorize the guide channel and user channel numbers you have entered. Or, press the Number 2 button to quit and select another pair of numbers.

SET GUIDE CHANNEL
TO SELECT PUSH NUMBER

GUIDE CH. 28

USER CH. 04

1 MEMORIZE

2 SELECT ANOTHER CH.

TO END PUSH EXIT

7

Repeat steps 5 and 6 for all the stations on your list which have different guide channel and user channel numbers.

8

Press the EXIT/STATUS button to exit.

9

To confirm the guide channel and user channel numbers you have selected, press the MENU button to bring up the main menu display. Then press the Number 2 button to select VCR SET UP. Finally, press the Number 5 button to select GUIDE CHANNEL MAP. A list of guide channel and user channel numbers memorized by the VCR will appear on-screen. If there are more than 10 pairs of numbers, press the Number 1 button to view another screen of numbers. Make sure these numbers correspond to the boxes you filled in in step 1. Then press the EXIT/STATUS button twice to exit.

GUIDE CHANNEL MAP

GUIDE : USER GUIDE : USER

01 : 01 02 : 02

03 : 03 04 : 04

05 : 23 06 : 06

07 : 07 08 : 91

09 : 09 10 : 10

NEXT=1 END=EXIT

Remote Control

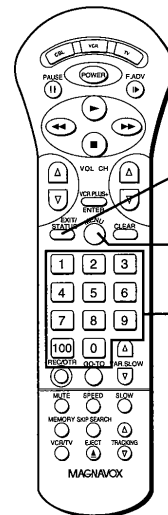
EXIT/STATUS
Button

MENU Button

Number
Buttons

NOTES

To correct a guide channel number:

- Repeat steps 3 – 4 on this page.
- At step 5, enter the incorrect guide channel number for both the guide channel and the user channel. Press the Number 1 button, then press the EXIT/STATUS button to exit. This will make the guide channel and user channel the same, as they were when you received your VCR.
- Repeat steps 3 – 6, this time entering the correct guide channel and user channel. Press the EXIT/STATUS button to exit.

To correct a user channel number:

- Repeat steps 3 – 6 on this page using the correct channel number. Press the EXIT/STATUS button to exit.

Timer Recording With VCR Plus+

Remote Control

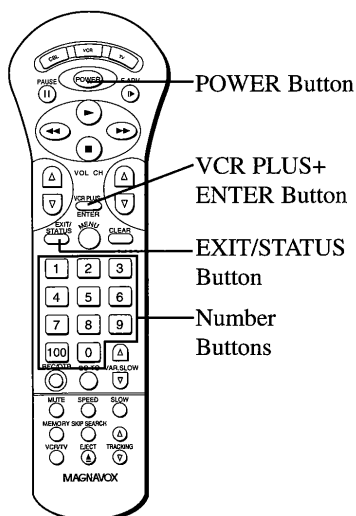

Follow the steps below to program a timer recording using VCR Plus+ numbers. Before you begin make sure:

- Channels have been programmed.
- The clock has been set.
- There is a tape in the VCR. Make sure the tape's record tab is intact and the tape is long enough to record the program(s).
- The VCR is in VCR position.
- You have selected CABLE TV or TV at the TUNER SET UP menu.

You must do each step within 60 seconds of completing the previous step. If you don't, you will have to start again at step 1.

1

Press the VCR PLUS+ ENTER button on the remote control. The on-screen display shown below will appear.

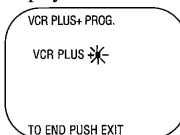

2

Use the Number buttons to enter the VCR Plus+ number of the program you wish to record (this number is different for every program, and it can be four to eight digits long). Finally, press the VCR PLUS+ ENTER button.

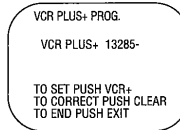

**The VCR
must be turned off
for a timer
recording to take
place.
Make sure there is
a tape in the
VCR.**

3

To record the program once, press the Number 1 button to select ONCE. To record the same program every day from Monday through Friday, press the Number 2 button to select DAILY. To record the same program every week on the same day (such as every Saturday), press the Number 3 button to select WEEKLY.

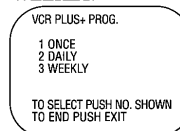

4

Press the Number 1 button or the Number 2 button to select SP (Standard Play) or SLP (Super Long Play). You cannot use the (Tape) SPEED button at this time.

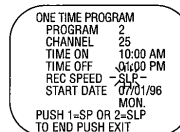

5

Press the EXIT/STATUS button. PROGRAM WAS COMPLETED / PLEASE TURN OFF VCR FOR TIMER RECORDING should appear on the screen (but if PROGRAM NOT COMPLETED appears, begin again from step 1). After five seconds, the on-screen display will disappear.

6

To program additional timer recordings with VCR Plus+, press the VCR PLUS+ ENTER button and repeat steps 2 to 5. **When you are finished, go to step 7.**

7

When you have finished, press the POWER button to turn the VCR off. The VCR must be turned off for a timer recording to take place. The TIMER light will appear on the display panel of the VCR when you turn off the VCR. The TIMER light will flash if there is not a tape in the VCR.

NOTES

- If you enter an incorrect VCR Plus+ number in STEP 2, ERROR appears for 4 seconds, then the on-screen display will go back to STEP 1. Re-check the VCR Plus+ number and enter it again.
- If ERROR appears at step 3 when you select DAILY with the Number 2 button, this means the VCR Plus+ number you have selected is for a program that is broadcast on Saturday or Sunday. The program cannot be recorded repeatedly from Monday through Friday.
- To quit VCR Plus+ programming at any step, press the EXIT/STATUS button. The on-screen display will disappear from the TV screen.
- See other NOTES about timer recording on pages 22 - 23 and 38.

Channel Memory

Programming Channels

Although your VCR may automatically memorize the channels you receive when you turn it on for the first time, this function lets you reprogram channels.

1

Press the VCR button, then press the MENU button to bring up the main menu display.

TO SELECT PUSH NO. SHOWN
 1 PROGRAM
 2 VCR SET UP
 3 TUNER SET UP
 4 INPUT SELECT
 5 SET CLOCK
 TO END PUSH EXIT

2

Press the Number 3 button to select TUNER SET UP.

TO SELECT PUSH NO. SHOWN
 1 TV
 2 CABLE TV (ON)
 3 AUTO PROGRAMMING
 4 ADD/DELETE CH
 5 CH MEMORY REVIEW
 TO END PUSH EXIT

3

Press the Number 1 button to select TV (if you have an antenna) or the Number 2 button to select CABLE TV (if you have a cable connection).

4

Press the Number 3 button to select AUTO PROGRAMMING. AUTO SET PROCEEDING / PLEASE WAIT will appear on-screen. The VCR will place all the channels you receive into its memory.

5

Wait for a few minutes while the VCR programs channels. When programming is complete, AUTO SET COMPLETED will appear on-screen. Then the programming of the lowest channel number placed in the VCR's memory will appear on-screen. Now when you press the CH(annel) Up/Down buttons you will scan only through channels you receive.

Remote Control

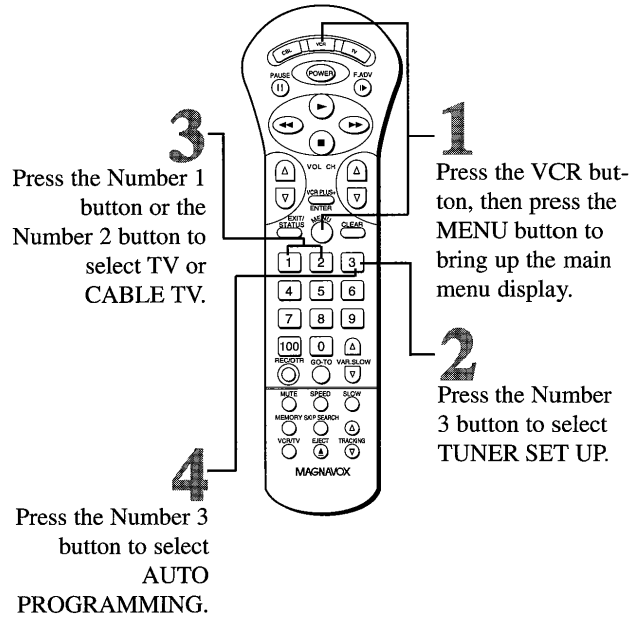

NOTES

Line Input mode will always be stored in the VCR's memory as channel 00 (although 00 will not appear on-screen when you press Number buttons 0, 0). When you select channel 00 with the CH(annel) Up/Down buttons or the Number buttons, L will appear on the display panel of the VCR.

Channel Memory (cont'd)

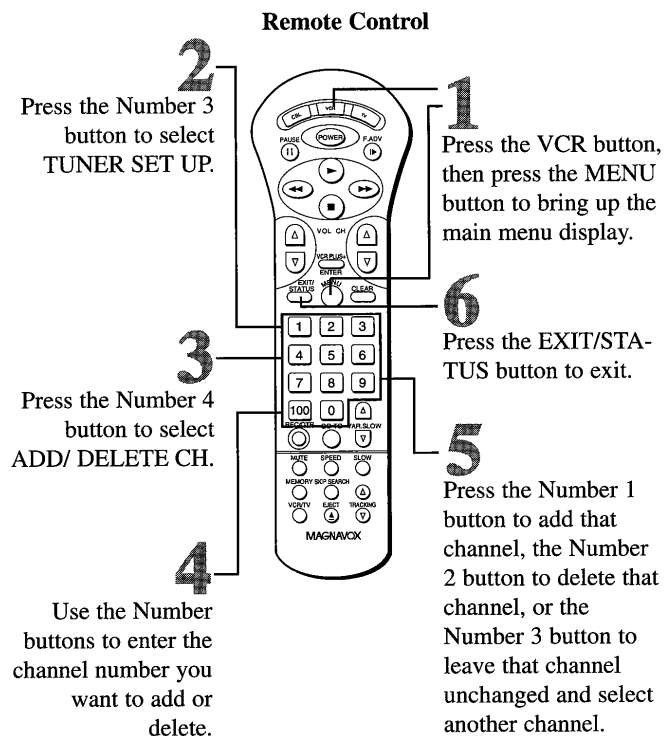

Adding/Deleting Channels

1 Press the VCR button, then press the MENU button to bring up the main menu display.

2 Press the Number 3 button to select TUNER SET UP.

3 Press the Number 4 button to select ADD/ DELETE CH.

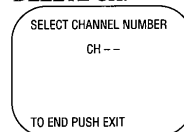

4 Enter the desired channel number with the Number buttons.

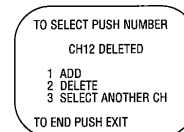

5 Press the Number 1 button to add that channel. Press the Number 2 button to delete that channel. Press the Number 3 button to cancel that entry and select another channel.

6 Press the EXIT/STATUS button to exit. The channel you added or deleted will appear on-screen.

Reviewing Programmed Channels

1. Press the MENU button to bring up the main menu display.
2. Press the Number 3 button to select TUNER SET UP.
3. Press the Number 5 button to select CH MEMORY REVIEW. A list of programmed channels will appear on-screen.
4. If all the programmed channels don't fit on the screen, press the Number 1 button to see the remaining channels. Then press the Number 2 button to return to the first screen of channels.
5. Press the EXIT/STATUS button twice to exit.

Language/Daylight-Saving Time Selection

Language Selection

Follow the steps below to change the language of the on-screen displays.

1

Press the VCR button, then press the MENU button to bring up the main menu display.

2

Press the Number 2 button to select VCR SET UP.

3

Press the Number 3 button to select LANGUAGE.

4

Press the Number 1 button if you want the on-screen displays in English. (ON) will appear to the right of ENGLISH on-screen. Press the Number 2 button if you want the on-screen displays in Spanish. (SI) will appear to the right of SPANISH on-screen.

5

Press the EXIT/STATUS button to exit.

Daylight-Saving Time Selection

Follow the steps below to program the VCR so its clock will automatically move forward one hour in April and turn back one hour in October.

1

Press the VCR button, then press the MENU button to bring up the main menu display.

2

Press the Number 5 button to select SET CLOCK.

3

Press the Number 2 button so that (ON) appears to the right of DAYLIGHT SAV TIME. Each time you press the Number 2 button, you turn DAYLIGHT SAV TIME ON or OFF.

4

Press the EXIT/STATUS button to exit.

Language Selection

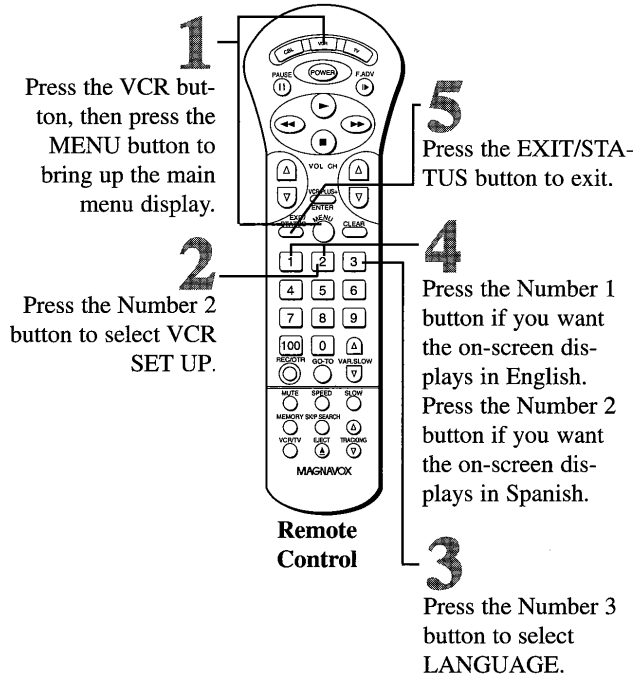

Daylight-Saving Time Selection

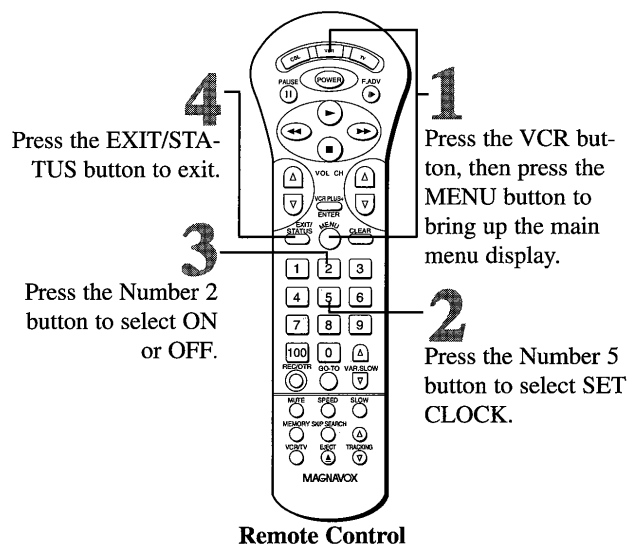

Playback Options

Remote Control

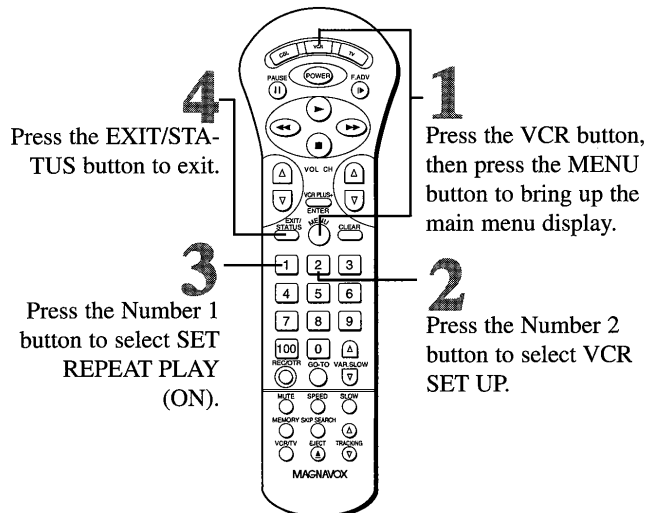

Repeat Playback

Follow the steps below to program the VCR to play a tape over and over.

1

Press the VCR button, then press the MENU button to bring up the main menu display.

TO SELECT PUSH NO. SHOWN

- 1 PROGRAM
- 2 VCR SET UP
- 3 TUNER SET UP
- 4 INPUT SELECT
- 5 SET CLOCK

TO END PUSH EXIT

2

Press the Number 2 button to select VCR SET UP.

TO SELECT PUSH NO. SHOWN

- 1 SET REPEAT PLAY (OFF)
- 2 ON SCREEN MODE
- 3 LANGUAGE
- 4 SET GUIDE CHANNEL
- 5 GUIDE CHANNEL MAP

TO END PUSH EXIT

3

Press the Number 1 button. (ON) will appear to the right of SET REPEAT PLAY.

Each time you press the Number 1 button, you turn SET REPEAT PLAY ON or OFF.

TO SELECT PUSH NO. SHOWN

- 1 SET REPEAT PLAY (ON)
- 2 ON SCREEN MODE
- 3 LANGUAGE
- 4 SET GUIDE CHANNEL
- 5 GUIDE CHANNEL MAP

TO END PUSH EXIT

4

Press the EXIT/STATUS button to exit. Now, when a tape has finished playing, the VCR will rewind it and start playback again. This will happen until you press the STOP button or until the tape has played 20 times. The Mode Light on the display panel will flash PLAY the entire time (even when the tape is rewinding). TV programming will appear while the tape is rewinding.

- The VCR will stay in Repeat Play mode until you cancel Repeat Play mode. To do this, follow steps 1 - 2 above. At step 3, press the Number 1 button to select SET REPEAT PLAY (OFF). Press the EXIT/STATUS button to exit.
- The tape counter will not operate when the VCR is in Repeat Play mode.

Playback Options (cont'd)

Using the Tape Counter

Follow the steps below to reset the tape counter to zero at a tape location you want to refer to later.

1

Play, fast forward or rewind a tape to the location that you would like to refer to later. Stop the tape.

2

Press the EXIT/STATUS button. The status display, which includes the tape counter, will appear on-screen.

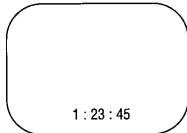

3

While the tape counter is still on-screen, press the CLEAR button to reset the tape counter to zero.

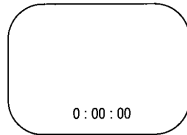

4

While the tape counter is still on-screen, press the MEMORY button to memorize the tape location. The Memory Light will appear on the display panel.

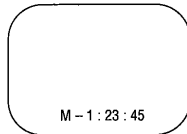

5

To return to the previous point at which the tape counter was reset to zero: when in Stop mode, press the REWIND/SEARCH button. To return to the next point at which the tape counter was reset to zero: when in Stop mode, press the FAST FORWARD/SEARCH button. The tape will go to the point at which the tape counter is set to zero, then stop. Press the PLAY button to watch the tape.

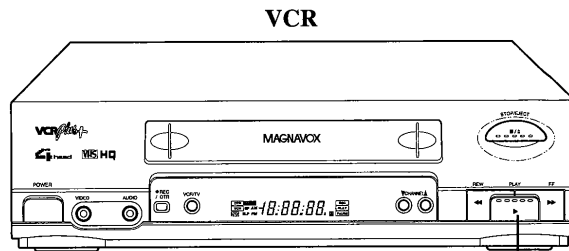

1

Play, fast forward, or rewind a tape to the location that you would like to refer to later. Stop the tape.

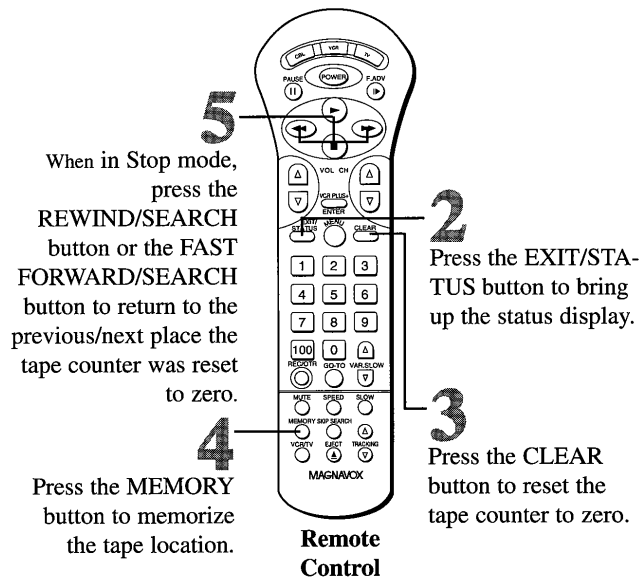

NOTES

- You may only set the tape counter to zero at one location at a time. If you try to set a second tape counter location to zero, the previous tape counter to zero setting will be erased.
- To erase the tape counter memory, press the MEMORY button. The Memory Light will disappear from the display panel.
- The tape counter memory does not operate if SET REPEAT PLAY is turned ON.

Playback Options (cont'd)

Remote Control

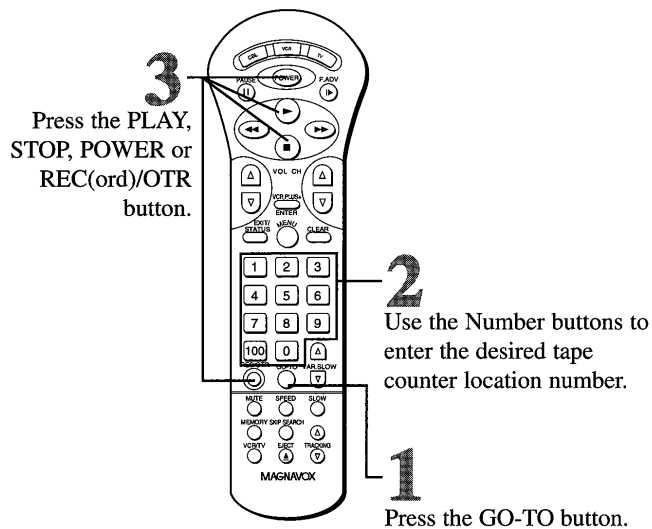

Using the Go-To Feature

Follow the steps below to program the VCR to go to a place on a tape with a specified tape counter location number.

1

While in Stop mode, press the GO-TO button to bring up the display shown below.

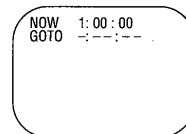

2

Within 10 seconds, use the Number buttons to enter the desired tape counter location number. For example, to go to tape counter location number 1:20:00, press Number buttons 1, 20, 00. *NOTE: If the desired tape counter number has a minus (-) before it, enter the minus by pressing the CH(annel) Down button. Press the CH(annel) Up button to remove the minus.*

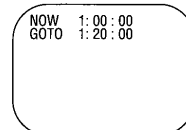

3

Press the PLAY, STOP, POWER or REC(ord)/OTR button. The VCR will fast forward or rewind the tape to the selected tape counter location. Then, depending on which button you pressed, it will either begin playback, stop, turn itself off, or start recording.

Button Pressed	VCR Action
PLAY	Begin playback
STOP	Stop
POWER	Turn off
REC(ord)/OTR	Begin recording

Playback Options (cont'd)

Forward and Reverse Searching

1

- When in play mode, press and release the FAST FORWARD/SEARCH button or the REWIND/SEARCH button. A fast forward or reverse picture search will begin. In SP, search speed is seven times the normal playback speed. In SLP, search speed is 21 times the normal playback speed. To return to playback, press the PLAY button.
- Or, press and hold the FAST FORWARD/SEARCH button or the REWIND/SEARCH button. In SP, search speed is seven times the normal playback speed. In SLP, search speed is 15 times the normal playback speed. When you release the button, normal playback will resume.

Viewing a Still Picture

1

When in Play mode, press the PAUSE button. A still picture (frozen image) will appear on-screen.

2

To advance the still picture frame-by-frame, press the F.(rame) ADV.(ance) button.

3

To release the still picture and return to normal playback, press the PAUSE button again or the PLAY button.

Viewing a Slow Motion Picture

1

When in Play mode, press the SLOW button. The tape will play in slow motion.

2

The speed of slow motion playback can be changed using the VAR.(iable) SLOW buttons.

3

To release Slow mode and return to normal playback, press the PLAY button.

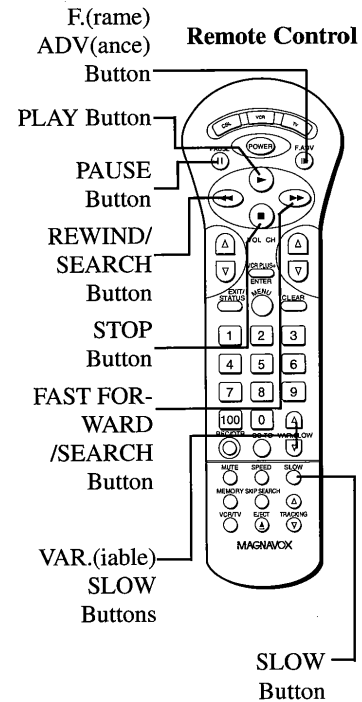

NOTES

- During Search, Slow and Still modes, there will be no sound.
- Slow and Still modes automatically switch to Stop mode after five minutes to protect the VCR and the tape from damage.
- In Search mode, noise bars will appear on-screen.

Playback Features

Remote Control

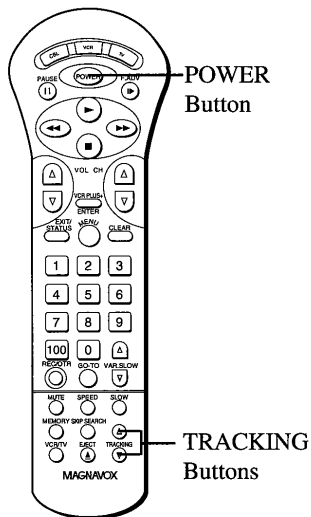

The following playback features will always operate:

Automatic Playback

When you put a tape in the VCR, the power will come on automatically. If the tape's record tab is missing, playback will begin.

Automatic Rewind

When a tape is played, fast forwarded, or recorded to its end, the VCR will rewind the tape, then go into Stop mode. If the Memory Light appears on the front display panel, the tape will stop at 0H00M00S on the counter.

Memory Rewind, Power Off

When the POWER button is pressed while the VCR is rewinding a tape, REWIND→POWER OFF will appear on-screen. When the tape has finished rewinding, the VCR will turn itself off. If the Memory Light appears on the front display panel, the tape will stop at 0H00M00S on the counter and the VCR will turn itself off.

Tape Eject

A tape can be ejected with the VCR power on or off (but the VCR must be plugged in).

Auto Tracking

The VCR has automatic tracking, which continually adjusts tracking to give you the best possible picture quality. With some recordings, however, you may get a better picture using the manual tracking controls (see below).

Manual Tracking

To adjust the tracking manually, press the TRACKING buttons on the remote control.

NOTES:

- You can adjust tracking manually during normal and slow motion playback.
- You can use the TRACKING buttons to remove jitter in a still picture.
- You can return to the Auto Tracking by pressing the CHANNEL Up/Down buttons on the VCR at the same time.
- Tracking is returned to the Auto Tracking whenever a tape is inserted.

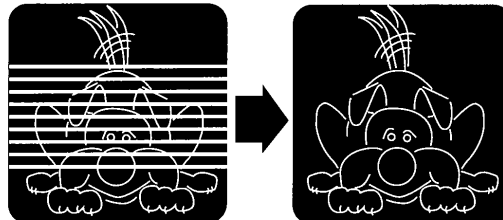

TV Code Setting

Your VCR remote control may operate your TV.

1

Point the remote control at your TV. Press the TV button, then press the POWER button, CH(annel) Up/Down buttons, and VOL(ume) buttons to see if the remote control operates your TV. If it does, stop. If it doesn't, go to step 2. If your TV does work, you're finished.

2

Find the brand of your TV on the list at the right and remember the two-digit number to the right of it.

3

Press the MUTE button, then press the TV button. Then use the Number buttons to enter the code for your TV. For example, if you have a Zenith TV, press Number buttons 1, 5.

4

Try step 1 again. If the remote control works your TV, you're finished. If the remote control still doesn't work your TV, try another code.

There is no guarantee that the remote control will work your TV.

Remote Control

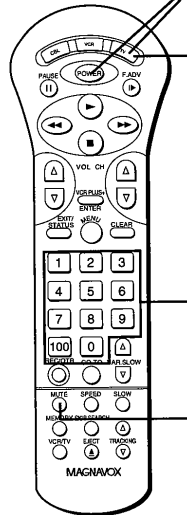

1

Press the TV button, then press the POWER button, CH(annel) Up/Down buttons, and VOL(ume) buttons to see if the remote control operates your TV. If it does, stop. If it doesn't, go to step 2.

3

Press the MUTE button, then press the TV button. Then use the Number buttons to enter the code for your TV.

2

Find the brand of your TV on this list and remember the two-digit number to the right of it.

TV CODES

MAGNAVOX . . .	01
MAGNAVOX . . .	02
MAGNAVOX . . .	03
EMERSON	14
GOLDSTAR	04
HITACHI	12
JVC	05
MITSUBISHI . . .	13
PANASONIC . . .	07
PANASONIC . . .	17
PHILIPS	01
RCA	10
SAMSUNG	18
SANYO	11
SHARP	16
SONY	09
TOSHIBA	08
ZENITH	06
ZENITH	15

NOTES

- Although the remote control that comes with your VCR will work most Magnavox TVs, as well as many TVs sold under other brand names, it is possible that the remote control will not operate your TV.
- If you had to program the remote control to operate your TV, whenever you replace the batteries in the remote control, you will have to program the remote control again.
- If you have a PHILIPS TV (TV code 01), you can use the remote control to operate other TV functions. Refer to the table at the right or read your TV owner's manual.

TV functions	Remote control
TV MENU	MENU button
MENU UP	PLAY button
MENU DOWN	STOP button
PLUS(+)	Fast Forward button
MINUS(-)	Rewind button
EXIT/STATUS	EXIT/STATUS button
100	100 button

Cable Converter Box Code Setting

Your VCR remote control may operate your cable converter box.

1

Point the remote control at your cable converter box. Press the CBL button, then the POWER button. If your cable converter box comes on, try the CH(annel) Up/Down buttons. If your cable converter box does not come on, or if the CH(annel) Up/Down buttons don't work, go to step 2.

2

Find the brand of your cable converter box on the list at the right and remember the two-digit number to the right of it.

3

Press the MUTE button, then press the CBL button. Then use the Number buttons to enter one of the codes for your cable converter box. For example, if you have a Zenith cable converter box, press Number buttons 1, 3.

4

Try step 1 again. If the remote control works your cable converter box, you're finished. If the remote control still doesn't work your cable converter box, try another code.

There is no guarantee that the remote control will work your cable converter box.

Remote Control

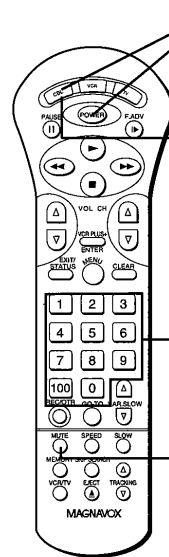

1

Press the CBL button, then press the POWER button and the CH(annel) Up/Down buttons to see if the remote control operates your cable converter box. If it does, stop. If it doesn't, go to step 2.

3

Press the MUTE button, then press the CBL button. Then use the Number buttons to enter the code for your cable converter box.

2

Find the brand of your cable converter box on this list and remember the two-digit number to the right of it.

CABLE CONVERTER BOX CODES

HAMLIN	.21
HAMLIN	.22
JERROLD	.01
JERROLD	.02
JERROLD	.03
JERROLD	.04
JERROLD	.05
JERROLD	.06
JERROLD	.07
OAK	.16
OAK	.17
OAK	.18
PANASONIC	.19
PANASONIC	.20
PIONEER	.11
PIONEER	.12
SCIENTIFIC ATLANTA	.08
SCIENTIFIC ATLANTA	.09
SCIENTIFIC ATLANTA	.10
TOCOM	.23
TOCOM	.24
TOCOM	.25
TOCOM	.26
ZENITH	.13
ZENITH	.14
ZENITH	.15

NOTES

- It is possible that the remote control will not operate your cable converter box.
- If you had to program the remote control to operate your cable converter box, whenever you replace the batteries in the remote control, you will have to program the remote control again.

Specifications

Video Heads

Four-heads

Video Signal

EIA standards; NTSC color

Antenna

VHF/UHF – 75 ohm external antenna terminal

VHF Output Signal

Channel 3 or 4 (switchable)
75 ohms unbalanced

Power Requirement

120V AC; 60 Hz

Power Consumption

19W

Operating Temperature

41°F (5°C) to 104°F (40°C)

Relative Humidity

10% to 80%

Weight

7.3 lbs. (3.3 kg.)

Dimensions

14-3/16" (W) x 3-3/4" (H) x 10-11/16" (D)
(360 mm x 94 mm x 271 mm)

Tuner Broadcast Channels

VHF 2-13, UHF 14-69

CATV Channels

Midband: A – 1

Superband: J – W

Hyperband: A-5 – A-1

Special Channel: 5A

Ultraband: 37 – 94, 100 – 125

NOTE: Designs and specifications are subject to change without notice.

Hooking Up Your VCR

If the reception on all channels is poor, you may need to tune your TV set again.

Timer Recording

- If the power fails, programmed timer recordings may be lost. If programmed timer recordings are lost, -- : -- should appear on the display panel. But, even if you do not see this indication, and the VCR appears to operate normally, check programmed timer recordings.
- It is best to finish programming a timer recording at least five minutes before the recording is scheduled to begin.
- If two timer recordings overlap, the program with the earliest start time will have priority. The next program will start only after the first program has been recorded.
- If the VCR power is turned off and there isn't a tape in the VCR, the TIMER and Cassette-Inside lights will blink.
- If the record tab on a tape is missing, the VCR will eject the tape. The TIMER and Cassette-Inside lights will blink.
- 12 PM is noon; 12 AM is midnight.

Satellite Hookups

- Watching one TV channel while recording another may not be possible if you have a satellite hookup.
- You may have to set your TV to channel 3 or 4, then make your channel selections at the satellite converter box.

Line Input

If you accidentally enter Line Input mode, use the CH(annel) Up/Down buttons or the Number buttons to select another channel.

Daylight-Saving Time

When automatic Daylight-Saving Time is set, the clock will change automatically as follows: on the first Sunday in April, from 2:00 AM to 3:00 AM; on the last Sunday in October, from 2:00 AM to 1:00 AM.

- During the April time change, a timer recording programmed to start between 2:00 AM and 2:59 AM will not record. A timer recording programmed to end between 2:00 AM and 2:59 AM will end when the clock moves forward (2:00 AM).
- During the October time change, a timer recording cannot be started between the second 1:00 AM and 1:59 AM.

Specifications/Notes (cont'd)

Other Hookups

Antenna/Cable to VCR to TV Hookups

- 1 Disconnect the antenna or cable from your TV (to avoid confusion, label all cable ends and jacks on the TV before disconnecting anything).
- 2 Connect the antenna or cable to your VCR.

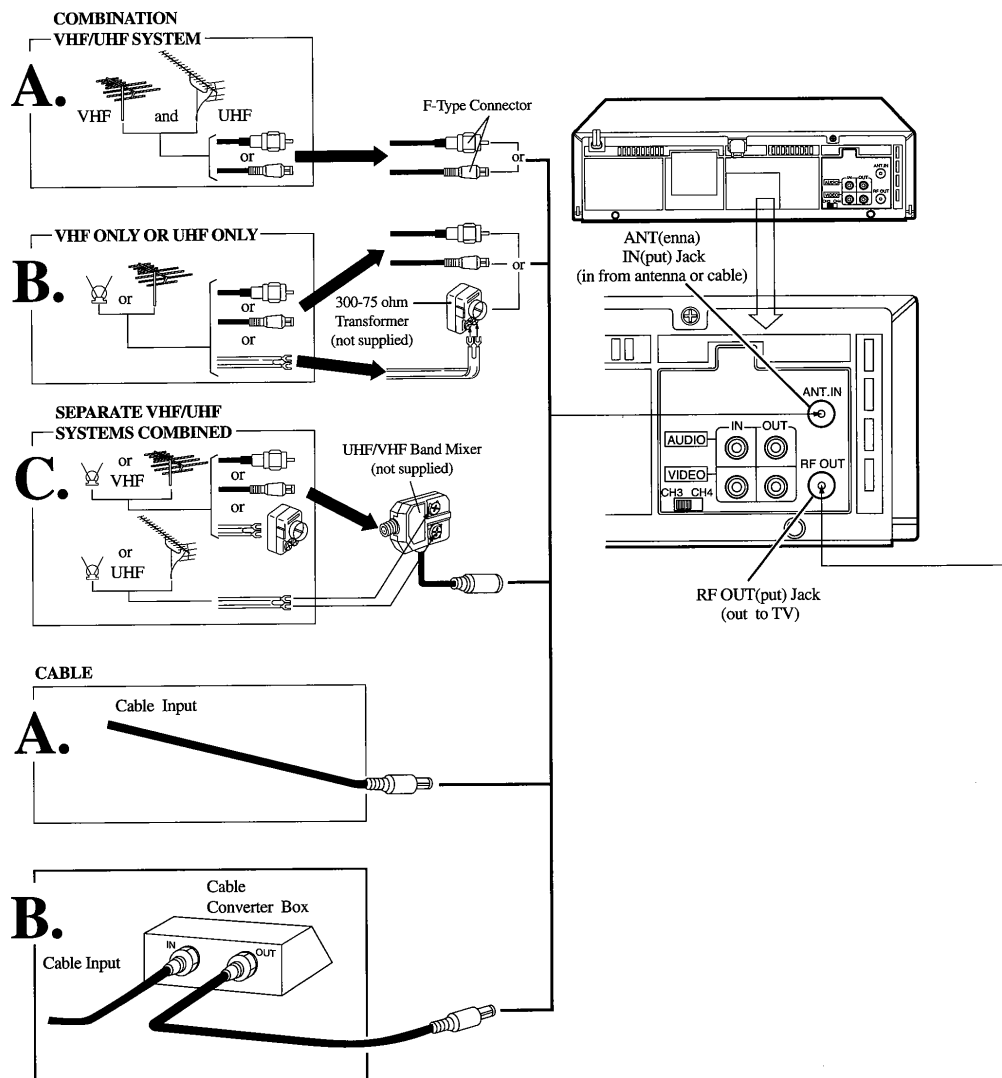

Other Hookups (cont'd)

3 Connect your VCR to your TV, using only one of the connections shown below.

4 Select channel 3 or 4 at the back of the VCR.

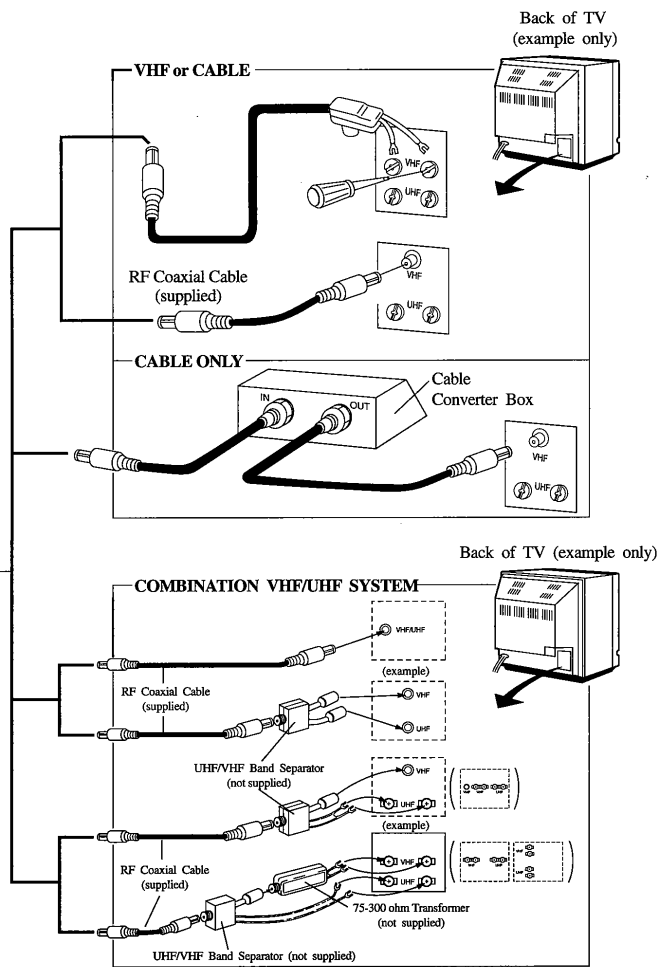

NOTES

If you have a UHF-only antenna system: Even if you only plan to play tapes and view/record UHF channels, you still need to make one of the combination UHF/VHF connections shown. This is because when your VCR operates, it sends VHF signals to the TV across the RF coaxial cable.

You may connect the cable converter box two different ways. See pages 42-43 before choosing how to connect the cable converter box.

Other Hookups (cont'd)

With a Converter/Descrambler Box

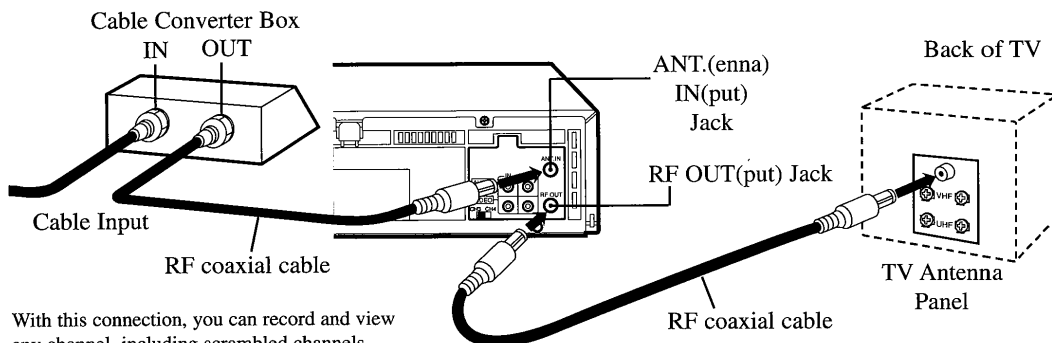

With this connection, you can record and view any channel, including scrambled channels. However, channel selections must be made at the cable converter box. This means that:

- Timer recordings are programmed differently than shown on pages 22 - 23.
 - You can only program a timer recording for one channel at a time.
 - When you are prompted to enter the channel you want to record, select channel 3 or 4 (whichever is the output channel of your cable converter box).
 - Set your cable converter box to the channel you want to record.
 - Leave the cable converter box on while you are recording.
- You cannot view a channel other than the one you are recording (the instructions on page 20 do not work with this hookup).
- You cannot program channels with this hookup (as discussed on pages 7 and 28).

Recording and Viewing a Scrambled or Unscrambled Channel

1

With the VCR on and in VCR position, use the CH(annel) Up/Down buttons to set the VCR to the output channel of the cable converter box (channel 3 or 4). Adjust the CH3/CH4 switch on the back of the VCR accordingly.

2

Set the TV to the same channel to which you set the VCR.

3

Select the channel you want to record at the cable converter box.

Watching TV With the VCR Off

1

Use the TV controls to set the TV to the same channel as the output channel of the cable converter box.

2

Use the cable converter box controls to select the channel you want to watch.

NOTES

- To do a timer recording with this hookup, see "Timer recordings are programmed differently..." above left.
- The cable converter box must be on during recording.

Other Hookups (cont'd)

With a (VCR to TV) Converter/Descrambler Box

This is an alternative to the connection shown on page 42. It allows you to program an unattended timer recording of more than one unscrambled channel and to watch one channel while recording another.

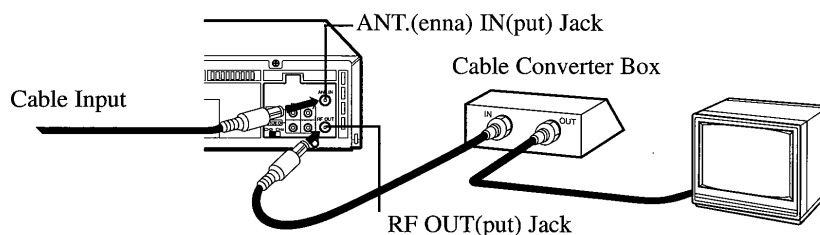

Recording One Channel/ Watching Another

1

With the VCR in VCR position, use the CH(annel) Up/Down buttons to select the channel you want to record. Start the recording.

2

Put the VCR in TV position.

3

Use the TV controls to put the TV on the same channel as the output channel of the cable converter box.

4

Select the channel you want to watch at the cable converter box.

Playing a Tape

1

Put the VCR in VCR position.

2

Use the TV controls to put the TV on the same channel as the output channel of the cable converter box.

3

Make sure the cable converter box is on the same channel as the VCR CH3/CH4 switch.

NOTES

- Use the CH(annel) Up/Down buttons to select the channel being recorded, even when doing a one touch recording.
- You cannot record scrambled channels with this connection.
- This connection may not work with your cable system.

44

Before Requesting Service

If you are having problems with your VCR, check the following list of problems and possible solutions before requesting service. You may be able to solve the problem yourself.

Power

No power

- Make sure the power plug is completely connected to an AC (alternating current) outlet.
- Make sure the power is turned on.

Power failure

- Follow the steps on page seven to select a language and program channels, if prompted to do so; then follow the steps on pages 10 - 12 to reset the clock.

Recording/Playback

A TV program cannot be recorded.

- Check the connections between the VCR, your TV, and the antenna/cable (page six).
- Make sure the band selected (VHF/UHF) matches your antenna/cable system.
- Make sure the tape has a record tab (page five).

The VCR will not perform a timer recording.

- Make sure the recording start and stop times are set correctly (pages 22 - 23).
- Make sure there is a tape in the VCR.
- Make sure the tape has a record tab.
- Make sure the VCR power is off.
- Make sure the clock is set (pages 10 - 12).
- The VCR may not perform or continue a timer recording if a power interruption of more than three minutes occurs during the timer recording, even if the power comes back on.

There is no playback picture, or the playback picture is noisy or contains streaks.

- Make sure the TV is on the same channel as the VCR's CH3/CH4 switch (page six).
- Make sure the VCR is in VCR position (pages 15, 16 and 18).
- Make sure channel 3 or 4 is properly adjusted.
- Adjust the tracking (page 35).

During special effects playback, the picture is noisy or contains vertical jitter when using a TV with an automatic vertical hold control.

- Set the TV's vertical hold control to manual, then adjust.

The top of the playback picture waves back and forth excessively.

- Because the VCR playback signal is not as stable as an off-the-air TV signal, the top of the TV screen may waver during playback. To stop this, slowly turn the horizontal hold control on the TV. If the TV does not have a horizontal hold control, or if adjusting the control does not help, contact your TV service center.

Remote Control

The VCR cannot be controlled with the remote control.

- Aim the remote control directly at the VCR's remote sensor (page five).
- Remove all obstacles between the remote control and the VCR (page five).
- Inspect and/or replace the batteries in the remote control (page five).
- Press the VCR button, then try the other buttons.

Number buttons won't work for channels above 69.

- Select CABLE TV from the tuner set up display (page 28) and let the VCR program the channels.

(continued on page 45)

Periodic maintenance is required to maintain your VCR's continued excellent performance. The video heads eventually will require cleaning or replacement. Cleaning or replacement of the video heads should be performed by an authorized service center.

(continued from page 44)

Miscellaneous

TV programs cannot be watched normally.

Tape can't be inserted.

Tape cannot be removed.

The VCR ejects the tape when the REC(ord)/OTR button is pressed or when the VCR power is turned off to set a timer recording.

The motor (cylinder) rotates even when the VCR is in Stop mode.

Channels above 13 cannot be received.

- Put the VCR in TV position (pages 15, 16 and 18).
- Check the connections between the VCR, your TV, and the antenna/cable (page six).
- Insert the tape window side up, with the record tab facing you.
- If a timer recording is set, the tape must have a record tab or the VCR will eject the tape.
- Make sure a tape isn't already in the VCR by pressing the STOP/EJECT button on the VCR.
- Gently push the center of the tape as you put it in the VCR. Never force a tape into the VCR.
- Make sure the power plug is completely connected to an AC (alternating current) outlet.
- You have set a timer recording. Turn the VCR power on, then eject the tape. Be sure to put a tape in for the timer recording.
- Make sure the tape has a record tab (page five).
- To enable the quick play mechanism, the cylinder will rotate for about five minutes. This is normal.
- Select CABLE TV from the tuner set up display (page 28) and let the VCR program the channels.

Glossary

AUDIO IN(put)/OUT(put) Jacks: jacks located on the front and back of the VCR which are used to record audio from another source (input) or send audio to another source (output).

Auto Programming: process in which the VCR scans all available channels and places the ones you receive in its memory. Then, when you press the CH(annel) Up/Down buttons, you only scan through channels you receive.

Bands: settings that allow you to tune channels.

- **Antenna** – VHF (very high frequency; channels 2 - 13) and UHF (ultra high frequency; channels 14 - 69).
- **Cable** – all standard channels can be received without a cable converter box.

Dubbing: copying a tape using a second VCR.

Frame: a single still picture.

HQ: high quality; a feature in the VCR circuitry which provides enhanced picture detail.

Matching Transformer: an adapter, used primarily on non-cable TVs, which has a "screw on" connector on one end and two flat prongs on the other end.

Mode: a VCR operation.

OTR: one touch recording; programming a timed recording that starts immediately and records for 30 minutes to nine hours, whatever you specify.

Remote Control: the small electronic unit that came with your VCR; allows you to operate your VCR from a distance.

Special Effects: forward and reverse searching, viewing a still or slow motion picture.

Separator: an adapter used to separate VHF and UHF signals when connecting the TV to the VCR.

Tape Speeds: how fast the tape travels during a recording or playback.

- **SP** (standard play) – fastest tape speed (recording time for a T120 tape is approximately two hours); best picture quality.
- **LP** (long play) – average tape speed; available for playback only.
- **SLP** (super long play) – slowest tape speed (recording time for a T120 tape is approximately six hours).

VCR: video cassette recorder.

VIDEO IN(put)/OUT(put) Jacks: jacks located on the front and back of the VCR which are used to record video from another source (input) or send video to another source (output).

LIMITED WARRANTY

VIDEO CASSETTE RECORDER

90 Days Free Labor

One Year Exchange Warranty on Parts

This product must be carried in for repair.

WHO IS COVERED?

You must have proof of purchase to receive warranty service. A sales receipt or other document showing that you purchased the product is considered proof of purchase.

WHAT IS COVERED?

Warranty coverage begins the day you buy your product. For 90 days thereafter, all parts will be repaired or replaced, and labor is free. From 90 days to one year from the day of purchase, all parts will be repaired or replaced, but you pay for all labor charges. After one year from the day of purchase, you pay for the replacement or repair of all parts, and for all labor charges.

All parts, including repaired and replaced parts, are covered only for the original warranty period. When the warranty on the product expires, the warranty on all replaced and repaired parts also expires.

WHAT IS EXCLUDED?

Your warranty does not cover:

- labor charges for installation or setup of the product, adjustment of customer controls on the product, and installation or repair of antenna systems outside of the product.
- product repair and/or part replacement because of misuse, accident, unauthorized repair or other cause not within the control of Philips Consumer Electronics Company.
- reception problems caused by signal conditions or cable or antenna systems outside the unit.
- a product that requires modification or adaptation to enable it to operate in any country other than the country for which it was designed, manufactured, approved and/or authorized, or repair of products damaged by these modifications.
- incidental or consequential damages resulting from the product. (Some states do not allow the exclusion of incidental or consequential damages, so the above exclusion may not apply to you. This includes, but is not limited to, prerecorded material, whether copyrighted or not copyrighted.)
- damage caused by the use of non-VHS tapes or tapes that have not been tested and labeled for use in two, four, six and eight hour VHS recorders.
- a product that is used for commercial or institutional purposes (including but not limited to rental purposes).

WHERE IS SERVICE AVAILABLE?

Warranty service is available in all countries where the product is officially distributed by Philips Consumer Electronics Company. In countries where Philips Consumer Electronics Company does not distribute the product, the local Philips service organization will attempt to provide service (although there may be a delay if the appropriate spare parts and technical manual(s) are not readily available).

MAKE SURE YOU KEEP...

Please keep your sales receipt or other document showing proof of purchase. Attach it to this owner's manual and keep both nearby. Also keep the original box and packing material in case you need to return your product.

BEFORE REQUESTING SERVICE...

Please check your owner's manual before requesting service. Adjustments of the controls discussed there may save you a service call.

TO GET WARRANTY SERVICE IN U.S.A., PUERTO RICO OR U.S. VIRGIN ISLANDS...

Take the product to a Philips factory service center (see enclosed list) or authorized service center for repair. When the product has been repaired, you must pick up the unit at the center. Centers may keep defective parts.

(In U.S.A., Puerto Rico and U.S. Virgin Islands, all implied warranties, including implied warranties of merchantability and fitness for a particular purpose, are limited in duration to the duration of this express warranty. Because some states do not allow limitations on how long an implied warranty may last, this limitation may not apply to you.)

TO GET WARRANTY SERVICE IN CANADA...

Take the product to a Philips consumer service center (listed below), self-servicing dealer or authorized service depot.

Philips Electronics Ltd.
601 Milner Avenue, Scarborough, Ontario, M1B 1M8
(416) 292-5161
4977 Levy Street, St. Laurent, Québec, H4R 2N9
(514) 956-0120
1741 Boundary Road, Vancouver, B.C., V5M 3Y7
(604) 294-3441

(In Canada, this warranty is given in lieu of all other warranties. No other warranties are expressed or implied, including any implied warranties of merchantability or fitness for a particular purpose. Philips is not liable under any circumstances for any direct, indirect, special, incidental or consequential damages, howsoever incurred, even if notified of the possibility of such damages.)

REMEMBER...

Please record the model and serial numbers found on the product below. Also, please fill out and mail your warranty registration card promptly. It will be easier for us to notify you if necessary.

MODEL # _____
SERIAL # _____

This warranty gives you specific legal rights. You may have other rights which vary from state/province to state/province.

Philips Service Company, P.O. Box 555, Jefferson City, Tennessee 37760, (423) 475-8869

EL4946E006 / MAC 4103 / 1-96

ac power cord	19	line input		still picture	34
accessories	48	mode	24, 38	stop button	15
audio input/output jacks	18, 19, 24	mode light	16	stop/eject button	18
automatic		long play	5	super long play	5
playback	35	lp.	5		
rewind	35			tape	
batteries	5	memory		counter	32
before requesting service	44-45	button	15	duplication	24
		rewind, power off	35	eject	35
		menu button	15	speed	5
		mode light	16	speed light	17
		mute button	14		
cable converter box		notes	38-39	table of contents	4
code setting	37	number buttons	14	timer	
connections	40-43	on-screen		light	16
cassette-inside light	16	displays	13	recording	
cassette (also see <i>tape</i>)		off mode	13	checking	22
compartment	16	on mode	13	clearing	22
channel 3/4 switch	6	one-touch recording	21	notes	38
channel		otr		programming	22-23
above 100	14	light	17	reviewing	22
adding	29	pause button	15	tracking	35
deleting	29	playback		tv	
memory	28-29	features	35	button	14
programming	7, 28	options	31-34	code setting	36
reviewing	29	play button	14, 18	controls	36
up/down buttons	14, 18	playing	8	hookup	6, 40-43
clear button	15	power button	14, 18	position	15, 18
clock		rear panel	19	vcr	
auto clock	10-11	rec(ord)/otr button	14, 18	button	14
manual clock	12	recording		light	16
code setting		basic	9	plus+	25-27
cable converter box	37	one channel/watching another	20	position	15, 18
tv	36	remote		vcr plus+	
connections	6, 40-43	control		setting	25-26
contents, table of	4	buttons	14, 15	timer recording	27
controls		using	5	vcr/tv button	15, 18
remote	14-15	sensor	5, 17	video	
vcr	16-19	repeat playback	31	input/output jacks	18, 19, 24
counter only mode	13	rerecording	24	tapes	5
		reverse searching	34		
daylight-saving time	30, 38	rew(ind) button	18		
display panel	16-17	rewind/search button	14		
duplication	24	rf coaxial cable	6, 40-43		
		rf output jack	19		
eject button	15	safety precautions	3		
erase protection	5	satellite hookups	38		
exit/status button	14	searching	34		
		skip search button	15		
f.adv button	14	slow			
fast forward button	18	button	14		
fast forward searching	34	motion	34		
fast forward/search button	15	slp.	5		
front panel	18	sp.	5		
		standard play	5		
glossary	45	status display	13		
go-to button	14				
go-to feature	33				
hookups					
basic	6				
other	40-43				
language selection	7, 30				

SUPPLIED ACCESSORIES

Check to be sure the items on this page are packed with your VCR. These accessories are provided to help you use or set up your VCR.

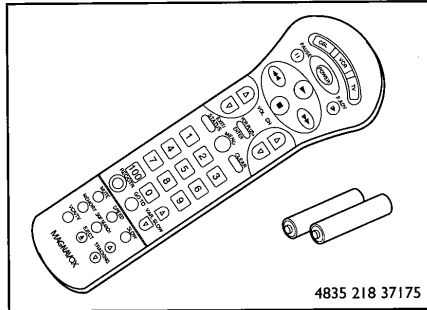

**One-Piece Wireless Remote Control
With 2 "AAA" Batteries (4835 138 17001)**

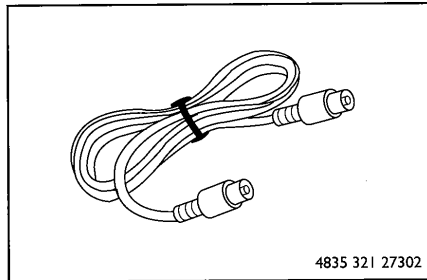

One-Piece RF Coaxial Cable, 75 ohm

If any of these items are not included, or if you need to replace an item, contact Philips Service Company at the address below.

**Philips Service Company
P.O. Box 967
Greenville, TN 37744-0967**

Or, call 1-800-851-8885.

187521E001
VCR-MAC4375
PU36278-175

Free Manuals Download Website

<http://myh66.com>

<http://usermanuals.us>

<http://www.somanuals.com>

<http://www.4manuals.cc>

<http://www.manual-lib.com>

<http://www.404manual.com>

<http://www.luxmanual.com>

<http://aubethermostatmanual.com>

Golf course search by state

<http://golfingnear.com>

Email search by domain

<http://emailbydomain.com>

Auto manuals search

<http://auto.somanuals.com>

TV manuals search

<http://tv.somanuals.com>