

Video Cassette Recorder
VRZ464AT

Owner's Manual

Important!
Return your Warranty Registration
Card within 10 days. See why inside.



PHILIPS MAGNAVOX

Return your Warranty Registration card today to ensure you receive all the benefits you're entitled to.

Once your PHILIPS MAGNAVOX purchase is registered, you're eligible to receive all the privileges of owning a PHILIPS MAGNAVOX product. So complete and return the Warranty Registration Card enclosed with your purchase at once. And take advantage of these important benefits.

Warranty Verification

Registering your product within 10 days confirms your right to maximum protection under the terms and conditions of your PHILIPS MAGNAVOX warranty.

Owner Confirmation

Your completed Warranty Registration Card serves as verification of ownership in the event of product theft or loss.

Model Registration

Returning your Warranty Registration Card right away guarantees you'll receive all the information and special offers which you qualify for as the owner of your model.

PHILIPS MAGNAVOX

Congratulations on your purchase, and welcome to the "family!"

Dear PHILIPS MAGNAVOX product owner:

Thank you for your confidence in PHILIPS MAGNAVOX. You've selected one of the best-built, best-backed products available today. And we'll do everything in our power to keep you happy with your purchase for many years to come.

As a member of the PHILIPS MAGNAVOX "family," you're entitled to protection by one of the most comprehensive warranties and outstanding service networks in the industry.

What's more, your purchase guarantees you'll receive all the information and special offers for which you qualify, plus easy access to accessories from our convenient home shopping network.

And most importantly you can count on our uncompromising commitment to your total satisfaction.

All of this is our way of saying welcome-and thanks for investing in a PHILIPS MAGNAVOX product.

Sincerely,



Robert Minkhorst
President and Chief Executive Officer

P.S. Remember, to get the most from your PHILIPS MAGNAVOX product, you must return your Warranty Registration Card within 10 days. So please mail it to us right now!



Know these

safety symbols



 This "bolt of lightning" indicates uninsulated material within your unit may cause an electrical shock. For the safety of everyone in your household, please do not remove product covering.

 The "exclamation point" calls attention to features for which you should read the enclosed literature closely to prevent operating and maintenance problems.

WARNING: TO PREVENT FIRE OR SHOCK HAZARD, DO NOT EXPOSE THIS EQUIPMENT TO RAIN OR MOISTURE.

CAUTION: To prevent electric shock, match wide blade of plug to wide slot, and fully insert.

ATTENTION: Pour éviter les chocs électriques, introduire la lame la plus large de la fiche dans la borne correspondante de la prise et pousser jusqu'au fond.

For Customer Use

Enter below the Serial No. which is located on the rear of the cabinet. Retain this information for future reference.

Model No. _____
Serial No. _____

PHILIPS MAGNAVOX Visit our World Wide Web Site at <http://www.philipsmagnavox.com>

Introduction 3

Welcome to your VCR owner's manual.

This manual has six sections: Setting Up Your VCR; Description of Controls; Basic Operations; Recording; Playing; and Information You May Need. The instructions explain all of the VCR's features, which are listed below.

Features

- Automatic Channel Setup
- Automatic Clock Setting
- Automatic Head Cleaner
- Battery Back-up
- Controller for Cable Box or Direct Broadcast System (DBS)
- Daylight-Saving Time
- Hi-Fi Stereo Tape Playback
- Incredible Picture
- Index Search
- Multi-Channel Television Sound (MTS) System
- 19 Micron Head
- On-Screen Menus in English, Spanish, or French
- Quick Programming
- Remote Control with Capability to Operate TV, Cable Box, and Direct Broadcast System (DBS)
- Repeat Play
- Skip Search
- VCR Plus+ Programming System
- Video Stabilizer

Safety Precautions

Warning: To prevent fire or shock hazard, do not expose this equipment to rain or moisture.

FCC Warning: Any unauthorized changes or modifications to this equipment void the user's authority to operate it.

This VCR, equipped with a High Quality (HQ) System, is compatible with existing Video Home System (VHS) equipment. This VCR also is equipped with S-VHS Quasi Playback (SQPB), allowing you to play S-VHS recordings with regular VHS resolution. However, you may not record on S-VHS tapes with this VCR. This product has a 19 micron head which provides a better picture when you view tapes recorded in slow speed (SLP).

Philips Consumer Electronics Company recommends that you use only video cassette tapes that have been tested and inspected for use in two, four, six, and eight hour VCRs, and which are labelled with the **VHS** mark. The use of tapes that have not been inspected for use in two, four, six, and eight hour VCRs may result in poor picture quality and excessive deposits on the video heads, which may not be covered by the warranty if damage occurs.

Note to the Cable TV System Installer: This reminder is provided to call the Cable TV system installer's attention to Article 820-40 of the National Electrical Code, which provides guidelines for proper grounding – in particular, specifying that the cable ground shall be connected to the grounding system of the building, as close to the point of cable entry as possible.

Operation is subject to the following two conditions: (1) this device may not cause interference, and (2) this device must accept any interference, including interference that may cause undesired operation of the device.

Your new product and its packaging contain materials that can be recycled and reused. Specialized companies can recycle your product to increase the amount of reusable materials and to minimize the amount that needs to be properly disposed.

Your product uses batteries that should not be thrown away when depleted but should be disposed of as small chemical waste. Please find out about the local regulations on disposal of your old product, batteries, and packaging whenever you replace existing equipment.



Copyright 1998 Philips Consumer Electronics Company. All rights reserved.
VCR Plus+ and PlusCode are trademarks of Gemstar Development Corporation. The VCR Plus+ system is manufactured under license from Gemstar Development Corporation.



The ENERGY STAR® name and logo are registered marks of the U.S. Environmental Protection Agency. As an ENERGY STAR® Partner, Philips Consumer Electronics Company has determined that this product or product model meets the ENERGY STAR® guidelines for energy efficiency.

4 Table of Contents

Setting Up Your VCR

Introduction	3
Table of Contents	4
Before Using Your VCR	5
Hookups Without a Cable Box	6 - 7
Hookups With a Cable Box/Direct Broadcast System	8 - 9
Installing/Removing the Lithium Battery	10
Turning on Your VCR	11 - 12
Automatic Channel Setup	13 - 14
Setting the Clock	15 - 19
Daylight-Saving Time	20
Language Selection	21

Description of Controls

Remote Control Buttons	22 - 23
Display Panel	24
Front Panel	25
Rear Panel	26
On-Screen Status Displays	27
Setting the Remote Control to Operate a TV	28
Setting the Remote Control to Operate a Cable Box/DBS	29

Basic Operations

Playing	30
Recording	31

Recording

One-Touch Recording	32
Recording One Channel/Watching Another	33
Setting Up the VCR Plus+ Programming System	34 - 35
Timer Recording With the VCR Plus+ Programming System	36 - 37
Quick Programming	38 - 41
Timer Recording Speed Setting	42
Connecting the Controller	43
Setting the Controller to Operate a Cable Box	44 - 45
Setting the Controller to Operate a DBS	46 - 47
Rerecording (Tape Duplication)	48

Playing

Index Search	49
Multi-Channel Television Sound System	50 - 51
Hi-Fi Stereo Tape Playback	52
Video Stabilizer	53
Incredible Picture	54
Playback Options	55 - 56
Automatic Operation Features	57

Information You May Need

Glossary	58
Specifications	59
Helpful Hints	60 - 61
Limited Warranty	62
Index	63
Supplied Accessories	64

Before Using Your VCR 5

Removing the Plastic Cover from the Front Panel

A thin, plastic cover may protect the front panel of your VCR. Before using the VCR, lift a corner of the plastic, then peel it off.

Putting Batteries in the Remote Control

1

To open the battery compartment, push in the tab, then pull up the lid.

2

Place two AA batteries inside the battery compartment with their + and - ends aligned as indicated.

3

Close the battery compartment lid.

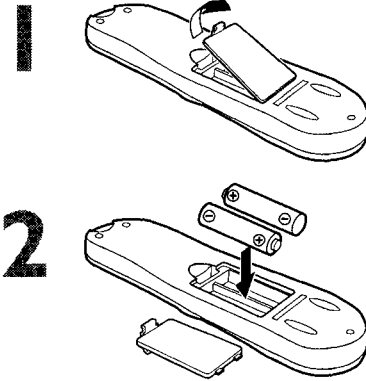

Using the Remote Control

- Do not put objects between the remote control and the VCR.
- Press the VCR button, then point the remote control at the VCR's remote sensor, before pressing other VCR operation buttons.
- Press the TV button, then point the remote control at the TV, before pressing other TV operation buttons.
- Press the CBL/DBS button, then point the remote control at the Cable Box/DBS, before pressing other Cable Box/DBS operation buttons.

Erase Protection

Video cassettes have record tabs to ensure that recordings are not erased accidentally.

1

To prevent accidental erasure, break off the tab with a screwdriver.

2

To record again, cover the hole with cellophane tape.

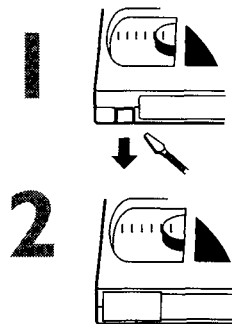

VCR Maintenance

- Remove any light adhesive stick-on notes from the video cassette before putting the cassette in the VCR. Removable labels can jam the VCR.
- Periodic maintenance is required to maintain your VCR's performance. Your VCR has an automatic head cleaner, but the video heads eventually will require cleaning or replacement. Cleaning or replacement of the video heads should be performed only by an authorized service center.

Helpful Hints

- The remote control and its batteries are supplied.
- Do not mix alkaline and manganese batteries.
- Do not mix old and new batteries.

6 Hookups Without a Cable Box

The basic VCR/TV connection – antenna/cable to VCR to TV – is shown below. If you have a Cable Box or a Direct Broadcast System, please refer to pages eight - nine. After you hook up the VCR, please go to page 11 to turn on the VCR.

1 Disconnect the antenna or cable from your TV.

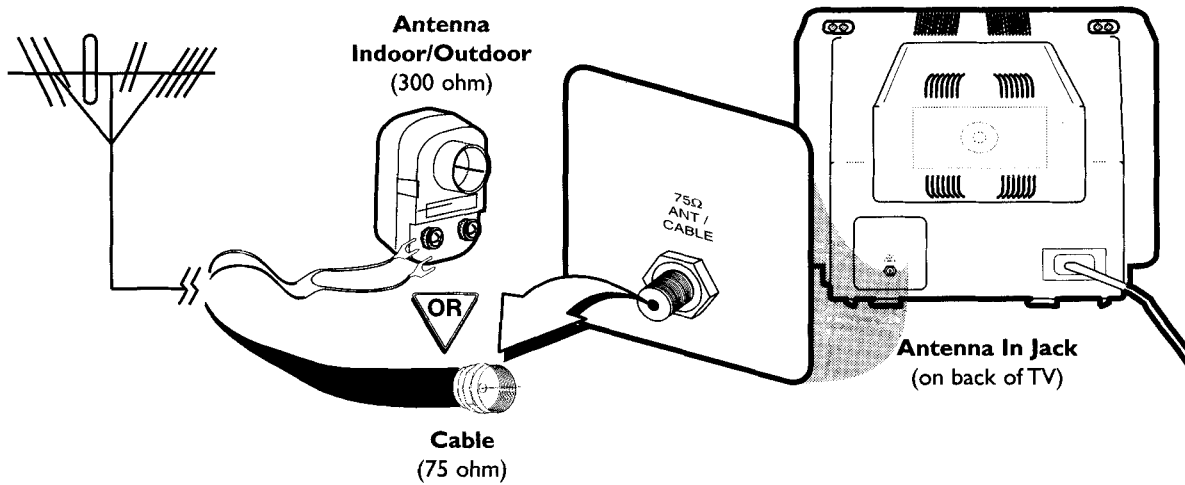

2 Connect the antenna or cable to the ANT(enna) IN Jack on the back of the VCR.

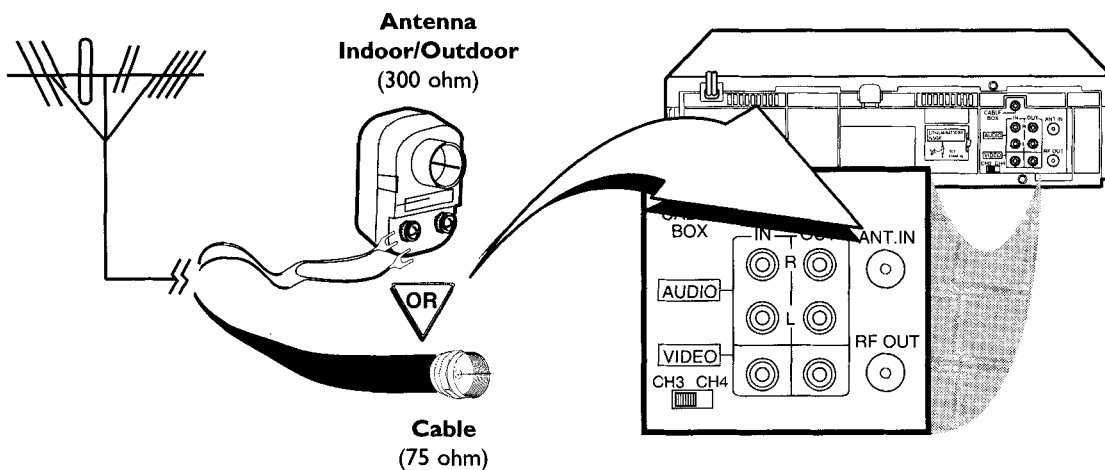

Hookups Without a Cable Box (cont'd) 7

3

Connect the RF coaxial cable (supplied) to the RF OUT Jack on the back of the VCR and to the ANTENNA IN Jack on the TV. (You may use either a snap-on type or screw-on type of coaxial cable, whichever you prefer. A snap-on type is supplied.)

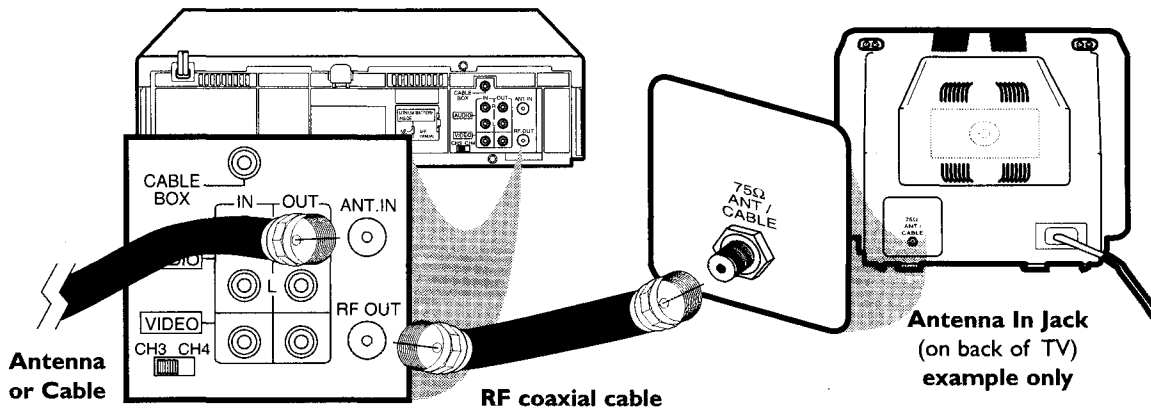

4

Plug in the TV and the VCR.

5

Set the CH3/CH4 switch on the back of the VCR to CH3 or CH4, whichever channel is not used or least used in your area. To operate your VCR with your TV, set the TV to the same channel. For example, when playing a tape, if the CH3/CH4 switch is set to CH3, the TV should be on channel 3.

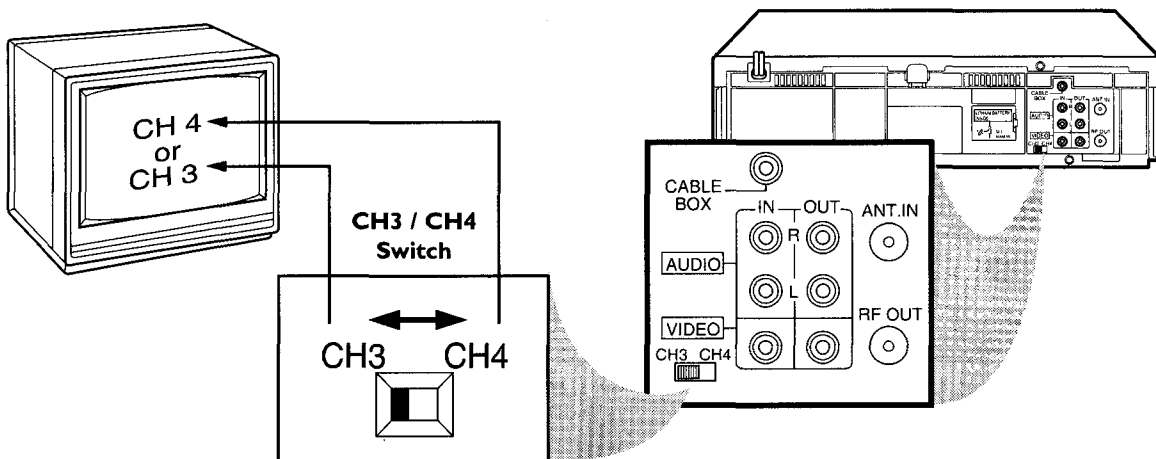

6

You are ready to turn on the VCR. Please go to page 11 before turning on the VCR.

8 Hookups With a Cable Box/Direct Broadcast System

There are two ways to connect your Cable Box/DBS to the VCR. With this connection:

- You may view any channel.
- You must select channels at the Cable Box/DBS. Channels cannot be changed at the VCR.
- You may not view a channel other than the one you are recording.
- You may not set up channels at the VCR.
- You can only program a timer recording for one channel at a time. Set the VCR to the Cable Box/DBS output channel (one of channels 02 to 09 for the Cable Box or channel 03 or 04 for the DBS), and set your Cable Box/DBS to the channel you want to record. When you enter the channel you want to record in a timer recording, select one of channels 02 to 09 for the Cable Box or channel 03 or 04 for the DBS (the Cable Box/DBS output channel). (This is step 3 on page 38.) Leave the Cable Box/DBS on for a timer recording.

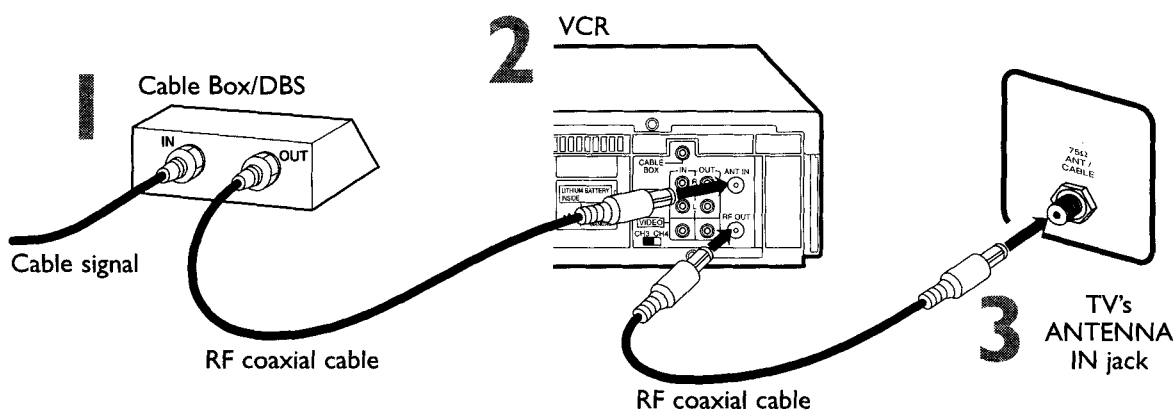

Connections

1

Connect a Cable signal to the IN jack on the Cable Box/DBS.

2

Use an RF coaxial cable (supplied) to connect the OUT jack on the Cable Box/DBS to the ANT(enna) IN jack on the VCR.

3

Use a second RF coaxial cable to connect the RF OUT jack on the VCR to the TV's ANTENNA IN jack.

Recording/Viewing Any Channel

1

With the VCR on and in VCR position (the VCR light will appear on the display panel), use the CH(annel) ▲/▼ buttons to set the VCR to the Cable Box/DBS output channel (one of channels 02 to 09 for the Cable Box or channel 03 or 04 for the DBS).

2

Select the channel you want to view/record at the Cable Box/DBS.

Hookups With a Cable Box/Direct Broadcast System (cont'd) 9

With this connection:

- You may watch one channel while recording another.
- You may not record scrambled channels.

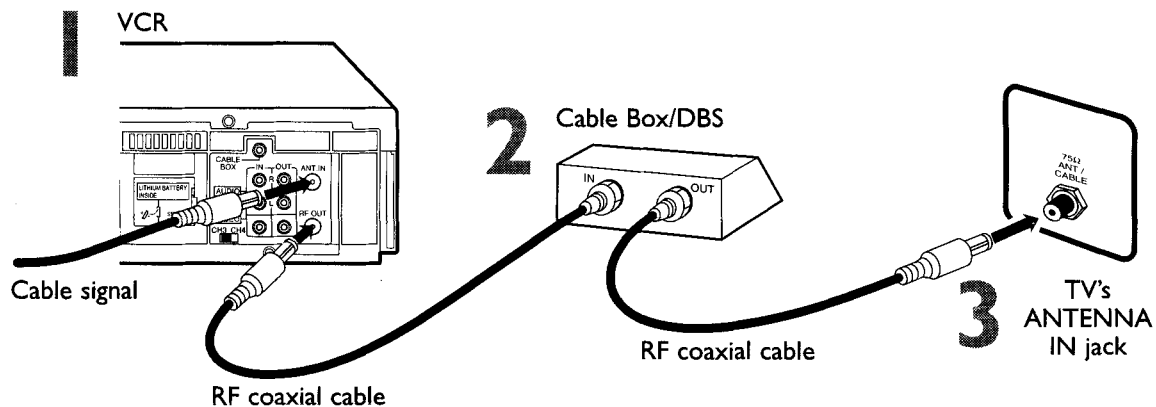

Connections

1

Connect a Cable signal to the VCR's ANT(enna) IN jack.

2

Use an RF coaxial cable (supplied) to connect the RF OUT jack on the VCR to the IN jack on the Cable Box/DBS.

3

Use a second RF coaxial cable to connect the OUT jack on the Cable Box/DBS to the TV's ANTENNA IN jack.

Recording One Channel/Watching Another

1

Put the Cable Box/DBS on the same channel as the VCR's CH3/CH4 switch. Put the TV on the Cable Box/DBS output channel. Then, with the VCR in VCR position (the VCR light will appear on the display panel), use the CH(annel) ▲/▼ buttons to select the channel you want to record at the VCR. Start the recording.

2

Press the VCR/TV button once to put the VCR in TV position. (The VCR light will disappear.)

3

Select the channel you want to watch at the Cable Box/DBS.

Helpful Hint

- When you play a tape, make sure the Cable Box/DBS is set to the same channel as the CH3/CH4 switch on the VCR. Set the TV to the Cable Box/DBS output channel (one of channels 02 to 09 for the Cable Box or 03 or 04 for the DBS).

10 Installing/Removing the Lithium Battery

You may install a lithium battery in the VCR. This will allow the VCR to save the clock setting and the programmed timer recordings if a power outage occurs. The battery can back-up your timer recordings and clock setting for around six months (4,000 hours). Connect the power plug to an AC outlet before installing the lithium battery; otherwise, the battery's life will be reduced greatly.

1

Connect the power plug to an AC outlet and turn off the VCR power.

2

To open the battery compartment, press the cover's release tab to the left, then remove the cover.

3

Press a lithium battery into the compartment with the plus (+) side up.

To remove the lithium battery, push the latch A downward using a pointed, non-metallic object.

4

Replace the battery compartment cover.

2

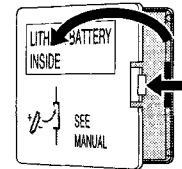

3

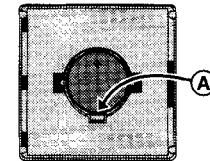

4

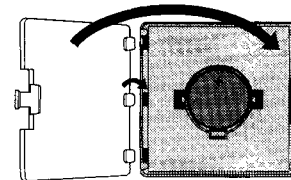

Lithium Battery Warning

The lithium battery may present a fire or chemical burn hazard if mistreated.

CAUTION: Risk of fire, explosion, and burns. Do not recharge, disassemble, heat above 100°C, or incinerate.

Replace the battery with a Panasonic (Matsushita Electric), Sanyo, Sony, or Maxell CR2025 only; use of another battery may present a risk of fire or explosion. To order a new battery, see page 64.

- Promptly dispose of used batteries.
- Keep the battery away from children.
- Do not dispose of the battery in a fire.

Turning on Your VCR 11

- Before turning on your VCR, make sure there are batteries in the remote control and the VCR, TV, and Cable Box/DBS (if applicable) are connected.
- The menus will continue to appear every time you turn on the VCR until you complete the steps on pages 11 - 12.
- If you want to set up the Controller now, you must first connect the Controller. See page 43.
- Leave the Cable Box turned on if you plan to set up the Cable Box Controller now.
- If you plan to set up the Controller now, set the Cable Box to a channel other than channel 09.

1

Press the **VCR** button, then press the **POWER** button.

2

Turn on the TV. Set it to channel 3 or 4, whichever the **CH3/CH4** switch on the back of the VCR is set to. The menu shown below will appear.

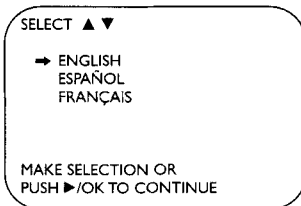

3

Press the **PLAY ▲** or **STOP ▼** button to select the on-screen display language.

4

Press the **FF ►/OK** button. The menu shown below will appear.

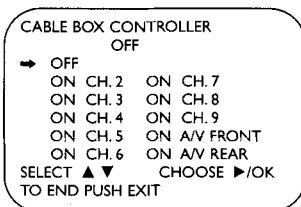

2

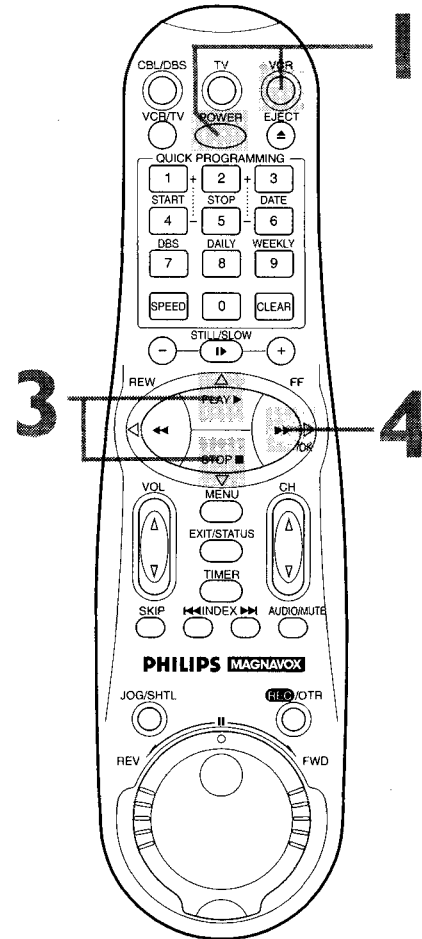
 Turn on the TV.

Instructions continue on page 12.

12 Turning on Your VCR (cont'd)

5

If you do not want to set up the Cable Box Controller now, press the FF ►/OK button to leave the Controller turned OFF. The display shown below will appear on-screen. Proceed to step 6. You may set up the Controller later by following the instructions on pages 43 - 47.

If you do want to set up the Cable Box Controller now, follow steps 5 - 8 on pages 44 - 45.

CONNECT ANTENNA OR CABLE
TO VCR

THEN PUSH ►/OK KEY

OR ...
FOR PLAY ONLY - PUSH STOP

6

Press the FF ►/OK button to begin automatic channel setup. AUTO CH. SET PROCEEDING PLEASE WAIT will appear on-screen. The VCR will memorize all of the channels you receive, so when you scan through channels using the CH(annel) ▲/▼ buttons, you'll only scan through channels that you receive.

7

When channels are set up, AUTO CH. SET COMPLETED will appear on-screen briefly.

7 Wait for the VCR to set up channels.

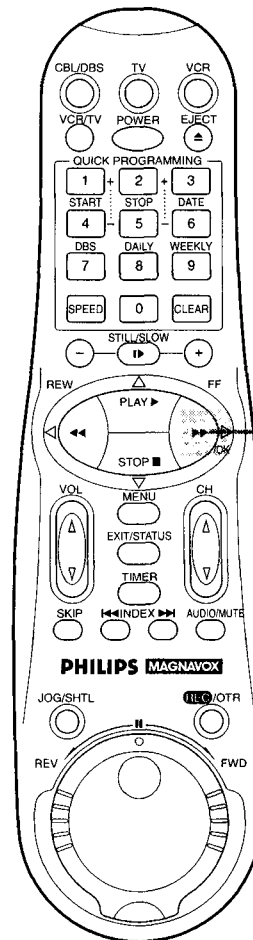

Helpful Hints

- Auto or --- :--- may appear on the display panel until the clock is set. After you connect the antenna/cable signal to the VCR and connect the VCR to a power source, the clock may set itself automatically. The current time may appear on the VCR display panel.
- If you do not want to set up channels now, press the STOP ▼ button at step 6. TUNER NOT SET will appear on-screen briefly.
- You may not set up channels at step 6 if you are using a Cable Box/DBS.

Automatic Channel Setup 13

Although your VCR may automatically memorize the channels you receive when you turn it on for the first time, this function lets you set up channels again. Make each entry within one minute of the previous entry.

1

Press the **VCR** button, then press the **MENU** button.

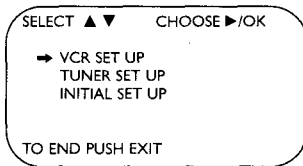

2

Press the **PLAY ▲** or **STOP ▼** button to select **TUNER SET UP**, then press the **FF ►/OK** button.

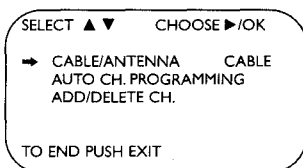

3

Press the **FF ►/OK** button repeatedly so that **ANT** (if you have an antenna) or **CABLE** (if you have a cable connection) appears beside **CABLE/AANTENNA**.

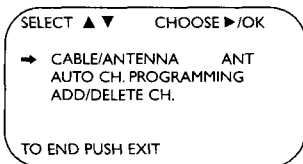

4

Press the **STOP ▼** button to select **AUTO CH. PROGRAMMING**, then press the **FF ►/OK** button. **AUTO CH. SET PROCEEDING PLEASE WAIT** and a scale that shows the progress of channel setup will appear on-screen. The VCR will memorize all the channels you receive.

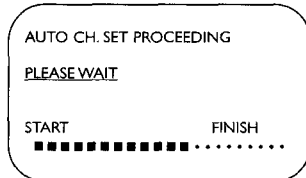
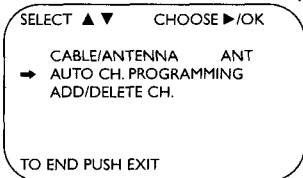

5

Wait for a few minutes while the VCR sets up channels. When programming is complete, **AUTO CH. SET COMPLETED** will appear on-screen. Then, the programming of the lowest channel number placed in the VCR's memory will appear on-screen. Now when you press the **CH(annel) ▲/▼** buttons, you will scan only through channels you receive.

5

Wait for the VCR to set up channels.

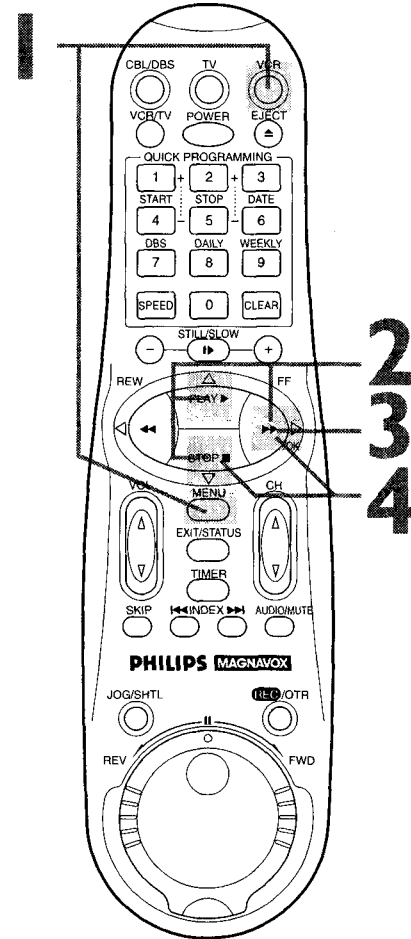

Helpful Hints

- If the channel you select has no broadcast, the screen will be solid blue.
- The two Line Input modes will always be stored in the VCR's memory at channel 00. To select **A/V IN FRONT** or **A/V IN REAR**, press 0,0, then press the **CH(annel) ▲/▼** buttons so that **L-F** appears on the display panel (for **A/V IN FRONT**) or **L-I** appears on the display panel (for **A/V IN REAR**). To exit Line Input mode, use the **CH(annel) ▲/▼** buttons to select a channel other than 00.

14 Automatic Channel Setup (cont'd)

Adding/Deleting Channels

1 Press the **VCR** button, then press the **MENU** button.

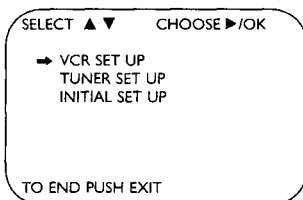

2

Press the **PLAY ▲** or **STOP ▼** button to select **TUNER SET UP**, then press the **FF ►/OK** button.

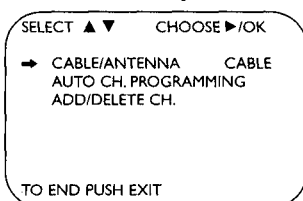

3

Press the **PLAY ▲** or **STOP ▼** button to select **ADD/DELETE CH.**, then press the **FF ►/OK** button.

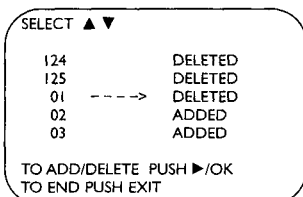

4

Use the **Number** buttons, the **CH (annel) ▲/▼** buttons, or the **PLAY ▲** or **STOP ▼** buttons to select the channel you want to add or delete. An arrow will appear beside the selected channel.

5

Press the **FF ►/OK** button so that **DELETED** or **ADDED** appears beside the channel number.

6

Press the **EXIT/STATUS** button. Programming of the channel you added or deleted will appear on-screen.

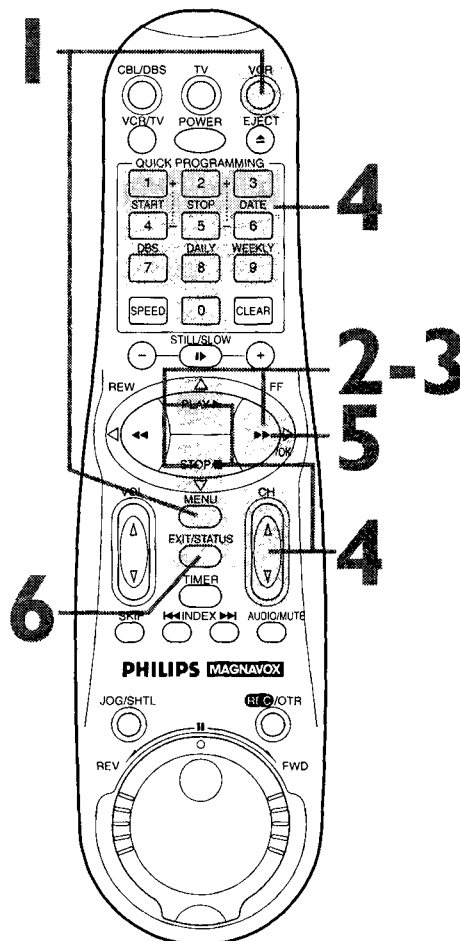

Setting the Clock 15

There are four ways to set the VCR's clock: Manually, with Time Zone Selection, with Manual PBS Channel Selection, or with Automatic PBS Channel Selection. Cable Box/DBS users must set the clock manually. Before you set the clock, make sure:

- The VCR power is on.
 - The VCR light appears on the display panel. If it does not, press the VCR/TV button once.
 - Channels are set up.
 - You make each entry within one minute of the previous entry.
- To set the clock manually, follow the steps on pages 15 - 16. To use Time Zone Selection, go to page 17. To use Manual PBS Channel Selection, go to page 18. To use Automatic PBS Channel Selection, go to page 19.

Manual Clock Setting

1 Press the **VCR** button, then press the **MENU** button.

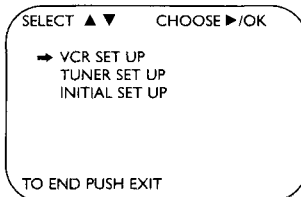

2

Press the **PLAY ▲** or **STOP ▼** button to select **INITIAL SET UP**, then press the **FF ►/OK** button.

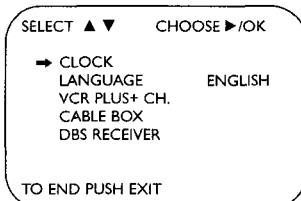

3

Press the **PLAY ▲** or **STOP ▼** button to select **CLOCK**, then press the **FF ►/OK** button. CABLE BOX USERS SET **CLOCK MANUALLY** may appear on-screen briefly, then a menu similar to the one shown below will appear. If **AUTO CLOCK** is set to **ON**, **PBS CH**, and **TIME ZONE** will also appear in the menu.

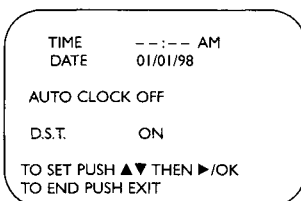

Instructions continue on page 16.

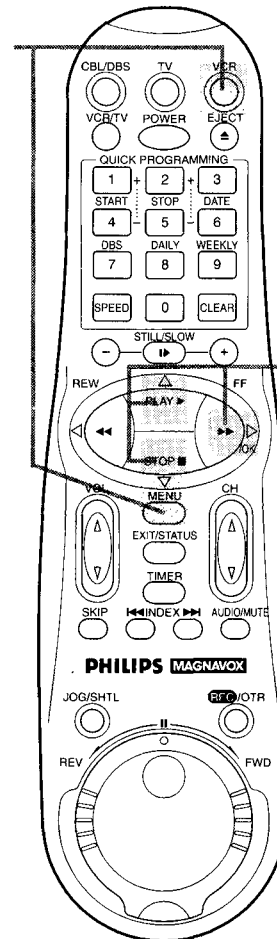

Helpful Hints

- To program the VCR so its clock will automatically move forward one hour in April and turn back one hour in October, see page 20.
- To make corrections, follow steps 1-3, then press the **FF ►/OK** button until the item you want to correct is flashing. Then press the **PLAY ▲** or **STOP ▼** button to enter the correct information. Press the **EXIT/STATUS** button.

16 Setting the Clock (cont'd)

4

Press the **PLAY ▲** or **STOP ▼** button repeatedly to set the **TIME**. Every time you press the **PLAY ▲** or **STOP ▼** button, the time changes in one minute increments. If you press and hold the **PLAY ▲** or **STOP ▼** button, the time changes in 30 minute increments.

When the time is correct, press the **FF ►/OK** button.

TIME	10 : 45 AM
DATE	01/01/98
AUTO CLOCK OFF	
D.S.T.	ON
TO SET PUSH ▲▼ THEN ►/OK TO END PUSH EXIT	

5

Press the **PLAY ▲** or **STOP ▼** button repeatedly to set the **DATE** (month and day). Every time you press the **PLAY ▲** or **STOP ▼** button, the day changes in one day increments. If you press and hold the **PLAY ▲** or **STOP ▼** button, the day changes in 15 day increments.

When the month and day are correct, press the **FF ►/OK** button.

TIME	10 : 45 AM
DATE	07/31/98
AUTO CLOCK OFF	
D.S.T.	ON
TO SET PUSH ▲▼ THEN ►/OK TO END PUSH EXIT	

6

Press the **PLAY ▲** or **STOP ▼** button repeatedly to set the **YEAR**. When the year is correct, press the **FF ►/OK** button. The day of the week will appear automatically.

TIME	10 : 45 AM
DATE	07/31/98
	FRIDAY
AUTO CLOCK OFF	
D.S.T.	ON
TO SET PUSH ▲▼ THEN ►/OK TO END PUSH EXIT	

7

Press the **FF ►/OK** button once again to skip the "AUTO CLOCK" selection and go to "D.S.T." (Daylight Saving Time) selection. Press the **PLAY ▲** or **STOP ▼** button to set **D.S.T.** to **ON**, **OFF** or **AUTO**. If **AUTO CLOCK** is set to **OFF**, you may only set **D.S.T.** to **ON** or **OFF**. For more information, please see page 20.

8

Press the **EXIT/STATUS** button.

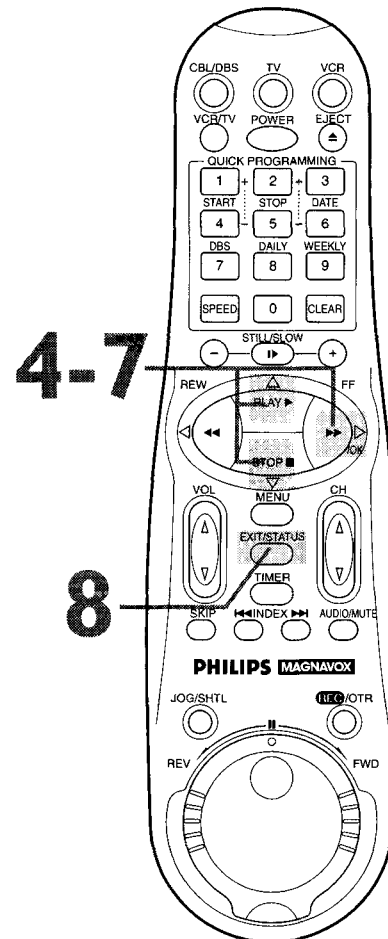

Setting the Clock (cont'd) 17

Time Zone Selection

1

Press the **VCR** button, then press the **MENU** button.

2

Press the **PLAY** ▲ or **STOP** ▼ button to select **INITIAL SET UP**, then press the **FF** ►/OK button.

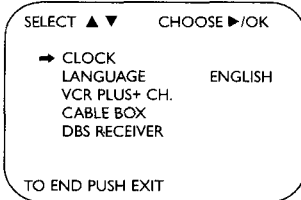

3

Press the **PLAY** ▲ or **STOP** ▼ button to select **CLOCK**, then press the **FF** ►/OK button.

CABLE BOX USERS SET CLOCK MANUALLY may appear on-screen. (If **AUTO CLOCK** is set to **OFF**, **TIME ZONE** will not be available in the menu. If this happens, press the **FF** ►/OK button to select **AUTO CLOCK**, then press the **PLAY** ▲ or **STOP** ▼ button to set **AUTO CLOCK** to **ON**.)

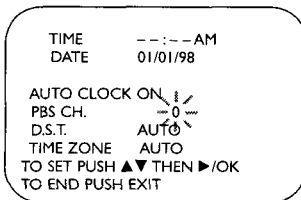

4

Press the **FF** ►/OK button repeatedly to select **TIME ZONE**.

5

Press the **PLAY** ▲ or **STOP** ▼ button repeatedly to select your **Time Zone**, then press the **FF** ►/OK button.

6

Press the **EXIT/STATUS** button.

7

An on-screen message will ask you to turn off the **VCR**, and **--:--AM** will appear on the display panel. Press the **POWER** button to turn off the **VCR**.

Auto will flash in the display panel until the clock is set. Leave the **VCR** power off until the time appears on the display panel.

If **--:--** appears on the display panel after you turn off the **VCR**, the **VCR** could not find the time. Set the clock following the steps on pages 15 - 16 or pages 18 - 19.

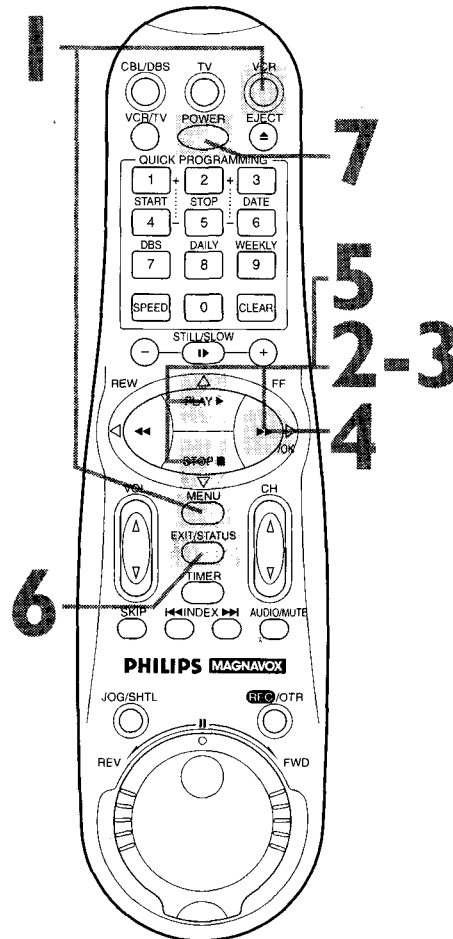

Helpful Hints

- When the power plug is connected to an AC outlet, the correct time will appear on the display panel of the VCR (when the power is off).
- If you live near the boundary of an adjacent time zone, your PBS channel may come from a different time zone. Select the time zone of your PBS channel at step 5.
- Press the **EXIT/STATUS** button repeatedly to make the time appear on the display panel when the **VCR** power is on.

18 Setting the Clock (cont'd)

Manual PBS Channel Selection

1

Press the **VCR** button, then press the **MENU** button.

2

Press the **PLAY ▲** or **STOP ▼** button to select **INITIAL SET UP**, then press the **FF ►/OK** button.

3

Press the **PLAY ▲** or **STOP ▼** button to select **CLOCK**, then press the **FF ►/OK** button. **CABLE BOX USERS SET CLOCK MANUALLY** may appear on-screen. (If **AUTO CLOCK** is set to **OFF**, **PBS CH.** will not be available in the menu. If this happens, press the **FF ►/OK** button to select **AUTO CLOCK**, then press the **PLAY ▲** or **STOP ▼** button to set **AUTO CLOCK** to **ON**.)

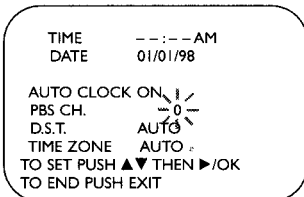

4

Press the **FF ►/OK** button to select **PBS CH.**

5

Press the **PLAY ▲** or **STOP ▼** button repeatedly to select the station number of your **PBS** channel, then press the **FF ►/OK** button.

6

Press the **EXIT/STATUS** button.

7

An on-screen message will ask you to turn off the **VCR**, and **--:--AM** will appear on the display panel.

Press the **POWER** button to turn off the **VCR**.

Auto will flash in the display panel until the clock is set. Leave the **VCR** power off until the clock is set.

If **--:--** appears on the display panel after you turn off the **VCR**, the **VCR** could not find the time. Repeat steps 1 - 6 above, entering a different **PBS** channel at step 5. Or, set the clock following the steps on page 19.

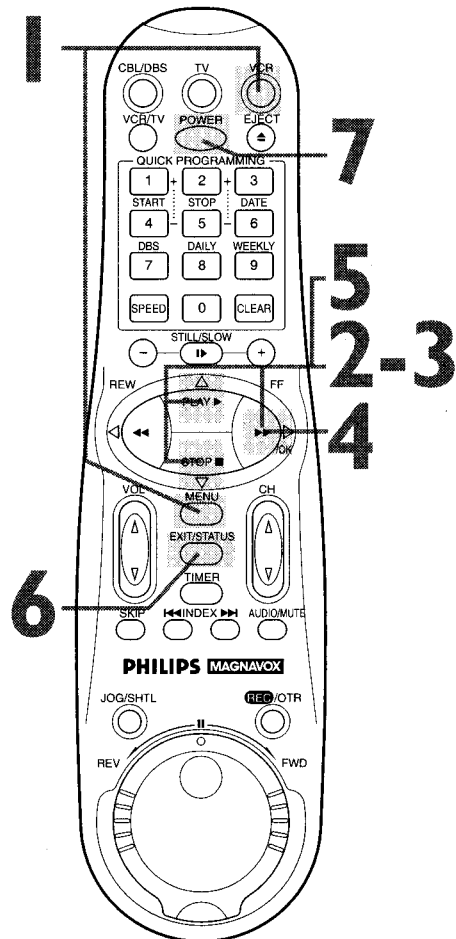

Helpful Hint

- The time will be updated at the top of each hour (except at 11 p.m., midnight, 1 a.m., and 2 a.m.).

Automatic PBS Channel Selection

1
Press the **VCR** button, then press the **MENU** button.

2
Press the **PLAY ▲** or **STOP ▼** button to select **INITIAL SET UP**, then press the **FF ►/OK** button.

3
Press the **PLAY ▲** or **STOP ▼** button to select **CLOCK**, then press the **FF ►/OK** button. **CABLE BOX USERS SET CLOCK MANUALLY** may appear on-screen briefly. (If **AUTO CLOCK** is set to **OFF**, **PBS CH.** will not be available in the menu. If this happens, press the **FF ►/OK** button to select **AUTO CLOCK**, then press the **PLAY ▲** or **STOP ▼** button to set **AUTO CLOCK** to **ON**.)

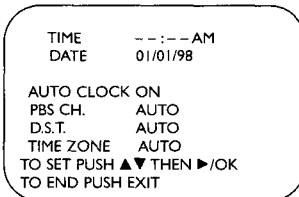

4
Press the **FF ►/OK** button to select **PBS CH.**

5
Press the **PLAY ▲** or **STOP ▼** button repeatedly so that **AUTO** flashes beside **PBS CH.** Then press the **FF ►/OK** button.

6
Press the **EXIT/STATUS** button.

7
An on-screen message will ask you to turn off the **VCR**, and **--:-- AM** will appear on the display panel. Press the **POWER** button to turn off the **VCR**.

Auto will flash in the display panel until the clock is set. Leave the VCR power off until the clock is set. If **--:--** appears on the display panel after you turn off the VCR, the VCR could not find the time. You may need to tell the VCR the PBS channel from which to take the time. Follow the steps on page 18.

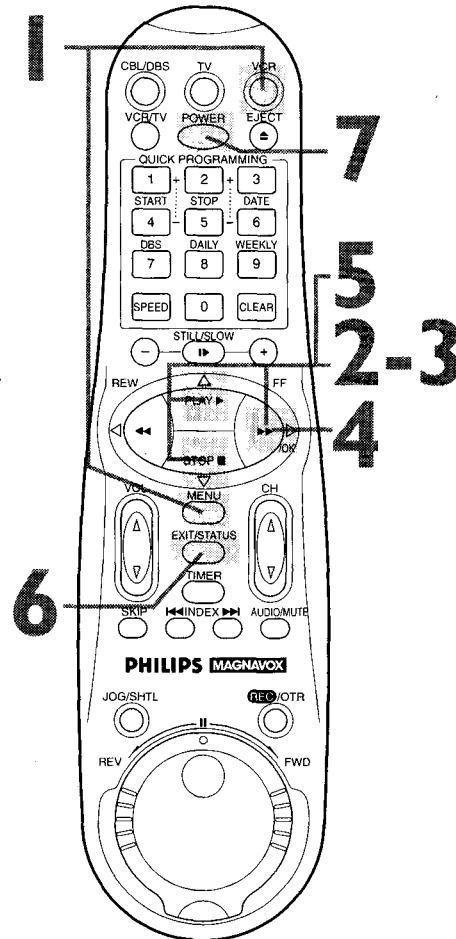

Helpful Hints

- The time will be updated at the top of each hour (except at 11 p.m., midnight, 1 a.m., and 2 a.m.).
- To display the time on-screen, press the **EXIT/STATUS** button. (**ON SCREEN MODE** can not be set to **OFF**.) Details are on page 27.

20 Daylight-Saving Time

Follow the steps below to program the VCR so its clock will automatically move forward one hour in April and turn back one hour in October.

1
Press the **VCR** button, then press the **MENU** button.

2
Press the **PLAY ▲** or **STOP ▼** button to select **INITIAL SET UP**, then press the **FF ►/OK** button.

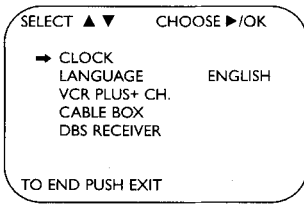

3
Press the **PLAY ▲** or **STOP ▼** button to select **CLOCK**, then press the **FF ►/OK** button. **CABLE BOX USERS SET CLOCK MANUALLY** may appear on-screen. (If **AUTO CLOCK** is set to **OFF**, **PBS CH.** and **TIME ZONE** will not appear in the menu.)

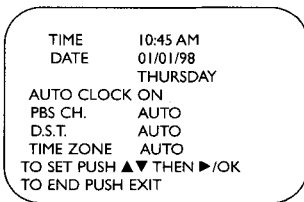

4
Press the **FF ►/OK** button repeatedly to select **D.S.T.**

5
Press the **PLAY ▲** or **STOP ▼** button so that **ON**, **OFF**, or **AUTO** appears beside **D.S.T.**

Select **ON** to make the clock adjust itself according to the VCR's calendar. Select **OFF** to turn off the feature. Select **AUTO** to make the clock adjust itself according to the signal it receives from the PBS channel. If **AUTO CLOCK** is set to **OFF**, you may only set **D.S.T.** to **ON** or **OFF**.

6
Press the **EXIT/STATUS** button.

7
An on-screen message will ask you to turn off the VCR. Press the **POWER** button to turn off the VCR. Auto will flash in the display panel until the clock is set. Leave the VCR power off until the clock is set. If **-- :--** appears on the display panel after you turn off the VCR, the VCR could not find the time. You may need to tell the VCR the PBS channel from which to take the time. Follow the steps on page 18.

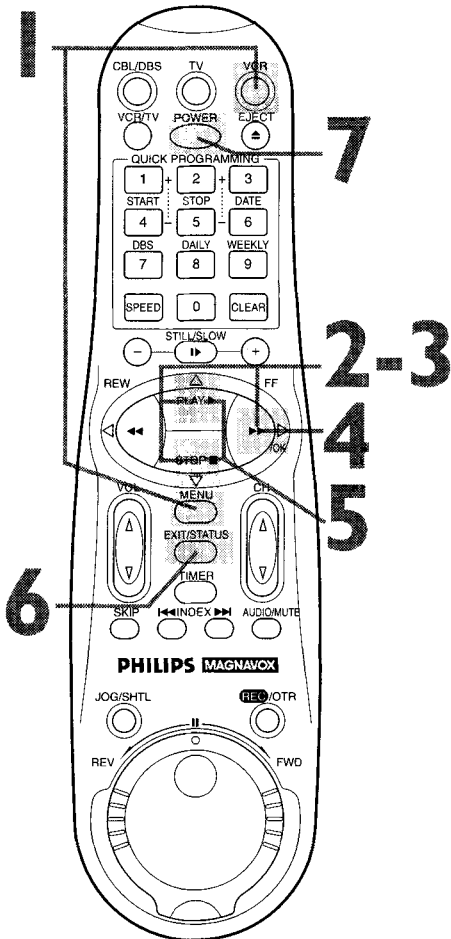

Language Selection 21

Follow the steps below to change the language of the on-screen displays.

1

Press the **VCR** button, then press the **MENU** button.

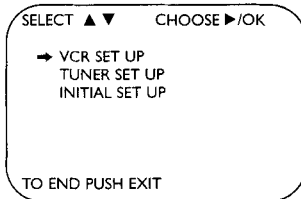

2

Press the **PLAY ▲** or **STOP ▼** button to select **INITIAL SET UP**, then press the **FF ►/OK** button.

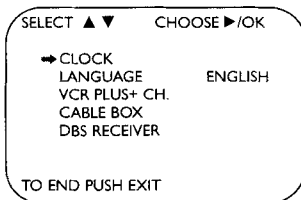

3

Press the **STOP ▼** button to select **LANGUAGE**.

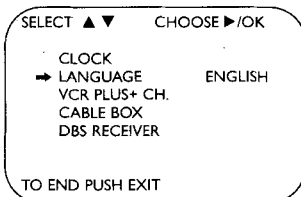

4

Press the **FF ►/OK** button repeatedly so that the language you want appears on-screen.

5

Press the **EXIT/STATUS** button.

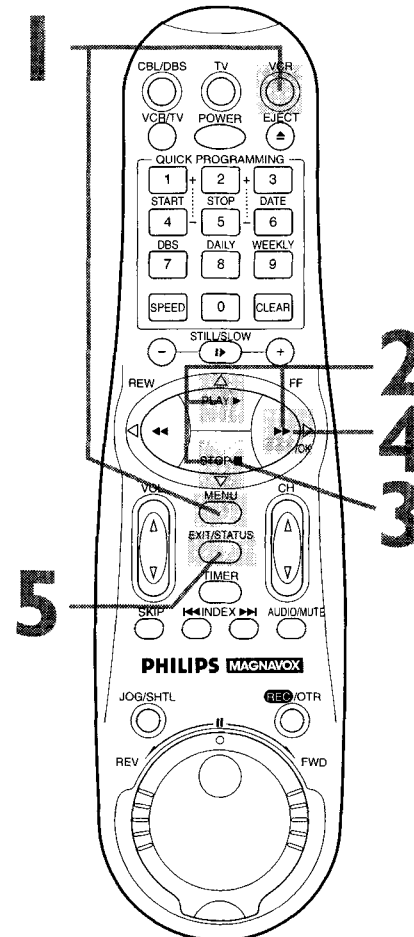

Helpful Hint

- If you accidentally select Spanish or French on-screen displays and need English on-screen displays, follow these steps. 1) Press the **VCR** button, then press the **MENU** button. 2) Press the **PLAY ▲** or **STOP ▼** button to select **SISTEMA INICIAL** or **PROGRAMM. INITIALE**, then press the **FF ►/OK** button. 3) Press the **PLAY ▲** or **STOP ▼** button to select **LENGUAJE** or **LANGUE**. 4) Press the **FF ►/OK** button repeatedly so that the English menu appears. 5) Press the **EXIT/STATUS** button.

22 Remote Control Buttons

TV Button

Press this button before pressing other TV operation buttons.

CBL/DBS Button

Press this button before pressing Cable Box/DBS operation buttons.

VCR/TV Button

Press to select the signal that your TV receives.

• VCR Position

Use to watch a tape, to watch a program while recording it, or to watch a TV broadcast using the CH(annel) ▲/▼ or Number buttons to change channels at the VCR. The VCR light will appear on the display panel when the VCR is in VCR position.

• TV Position

Use to watch TV (selecting channels at the TV) or to watch one program while recording another. *Details are on page 33.* The VCR light will not appear when the VCR is in TV position.

REW(ind) ◀ Button

When tape playback is stopped, press to rewind the tape at high speed. During tape playback, press to rewind the tape while the picture stays on-screen. *Details are on page 55.* Press to adjust (decrease) the picture controls or to change a menu setting at the TV menu.

STOP ▼ Button

Press to stop the tape. Or, press to move down or backward one row or selection in the TV menu.

JOG/SHTL(shuttle) Button

Press to use the Jog Dial or the Shuttle Ring.

VCR Button

Press this button before pressing VCR operation buttons.

POWER Button

After pressing the CBL/DBS, VCR, or TV button, press to turn on or off the Cable Box/DBS, VCR, or TV.

EJECT Button

Press to eject the tape.

PLAY ▲ Button

In VCR mode, press to play a tape. Also, press to release Slow, Still, or Search mode and to return to normal playback. Press and hold the PLAY ▲ button for at least five seconds to have the VCR play a tape repeatedly. *Details are on pages 55 - 56.* In TV mode, press to move up or forward one row or selection in the TV menu.

FF (Fast Forward) ▶/OK Button

When tape playback is stopped, press to advance the tape at high speed. During tape playback, press to advance the tape while the picture stays on-screen. *Details are on page 55.* Or, press to adjust (increase) the picture controls or to change a menu setting at the TV menu.

REC(ord)/OTR Button

Press once to start a recording. *Details are on page 31.* Or, press repeatedly to start a One-Touch Recording. *Details are on page 32.*

Jog Dial

Turn this dial for frame by frame tape playback. The tape moves backward or forward frame by frame at the speed with which the dial is turned. *For details, see page 56.*

Shuttle Ring

Turn this ring in either direction for forward or reverse searching of a tape. The farther the ring is rotated, the faster the search speed. Releasing the ring stops the picture in the Still mode, *For details, see page 56.*

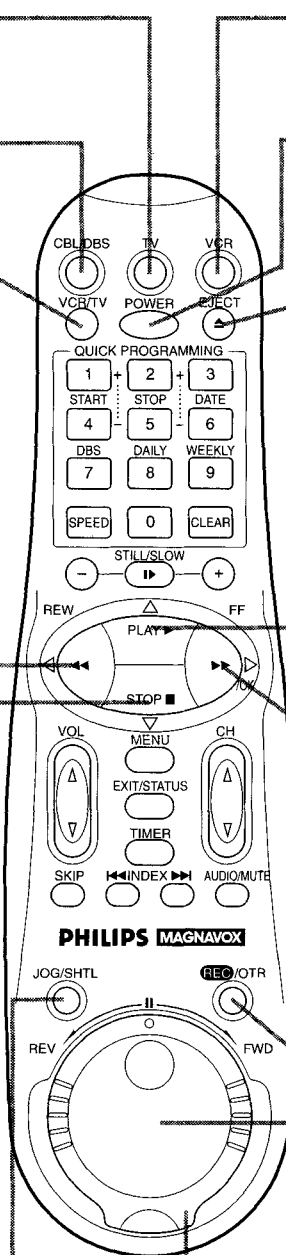

Remote Control Buttons (cont'd) 23

SPEED Button

Press to select a recording speed (SP or SLP). Details are on pages 39 and 58.

STILL/SLOW Button

While recording, press to temporarily stop the recording. Press a second time to resume normal recording. Details are on page 31. During tape playback, press once to freeze the picture. Press repeatedly to advance the Still picture frame by frame. Details are on page 55.

During tape playback, press and hold for more than three seconds to play the tape back in slow motion. Details are on page 55.

STILL/SLOW +/- Buttons

During slow motion tape playback, press to adjust the playback speed. Press the - button to play the tape in slow motion backward. Details are on page 55.

VOL(ume) ▲/▼ Buttons

Press to increase or decrease the TV's volume.

EXIT/STATUS Button

Press to exit on-screen menus. Press to bring up the status display for five seconds. Details are on page 27. When tape playback is stopped, press repeatedly to see the real-time counter, the current channel, or the current time on the display panel. During tape playback, press repeatedly to see the current time or the real-time counter on the display panel. Or, press the TV button, then press the EXIT/STATUS button to access the TV on-screen displays or to exit the TV menu.

SKIP Button

Press during tape playback to fast forward 30 seconds of a tape. This feature will only work with tape segments recorded in SP or SLP speed.

Number Buttons

After pressing the CBL/DBS, TV, or VCR button, press to select a channel at the Cable Box/DBS, TV, or VCR. To select channels 1-9, press 0, then the channel you want. For example, to select channel 7, press 0, 7.

CLEAR Button

Press to reset the real-time counter to zero.

MENU Button

Press to access the main VCR menu. Or, press the TV button, then the MENU button, to access the TV menu. Press again to remove the menu.

CH(annel) ▲/▼ Buttons

After pressing the CBL/DBS, TV, or VCR button, press to scan through the channels of the Cable Box/DBS, TV, or VCR.

TIMER Button

Press to access the timer recording menu. Details are on pages 36 - 41.

AUDIO/MUTE Button

Press the TV button, then press the AUDIO/MUTE button to eliminate the TV's sound. Press again to restore the sound. Or, press the VCR button, then press the AUDIO/MUTE button, to select MONO or HI-FI. Details are on page 52.

INDEX Buttons

When the tape is stopped, press to search for index codes recorded on the tape. Details are on page 49.

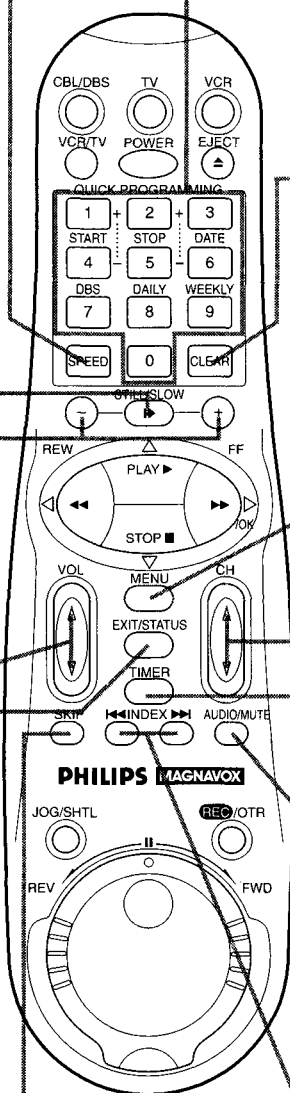

Helpful Hints

- This remote control may or may not operate your TV or Cable Box/DBS. Or, it may only work on some features of this equipment. See pages 28 - 29 for details.
- The PLAY ▲, STOP ▼, REW(ind) ◀, FF ▶/OK, VOL(ume) ▲/▼, and CH(annel) ▲/▼ buttons will light for 10 seconds when you press one of the buttons.

24 Display Panel

VCR Display Panel

Information about VCR operations appears here. Different information appears at different times. The display is brighter when the VCR power is on. The display dims automatically when you turn off the VCR power.

Remote Sensor

Receives a signal from your remote control so you can operate your VCR from a distance. Press the VCR button on the remote control before pressing other VCR operation buttons.

Cassette Compartment

Insert a tape here.

TIMER Light

This light appears when a timer recording is programmed or is in progress. Details are on pages 36 - 41. This light blinks rapidly if the VCR is turned off to set a Timer Recording but a tape is not in the VCR.

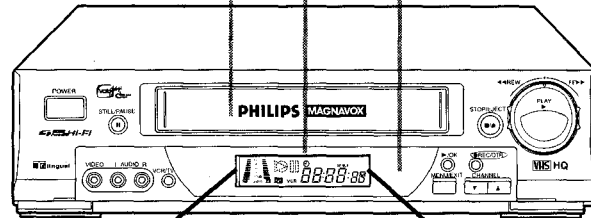

Tape Speed Lights

This light indicates the current tape speed. This VCR will play tapes recorded in LP speed, but LP will not appear on the display panel. This VCR will not record in LP speed. Details on tape speeds are on pages 39 and 58.

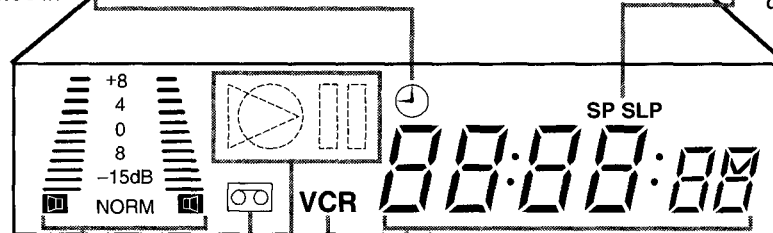

Audio Level Indicator

This indicator shows the audio playback level. NORM appears only when you select MONO at step 3 on page 52.

Cassette-Inside Light

This light appears when a tape is in the VCR. It blinks when a tape is being ejected. This light blinks rapidly if the VCR is turned off to set a Timer Recording but there is not a tape in the VCR.

Operation indicators

These indicators tell you the current operation of the VCR.

- ▷: Play, Forward and Reverse Searching
- : Record
- ◻: Record Pause
- ▷◻: Still Picture

VCR Light

This light appears when the VCR is in VCR position.

Clock/Counter/Channel Display

Each time you press the EXIT/STATUS button, information on the display panel will change. When tape playback is stopped, press the EXIT/STATUS button repeatedly to see: the current time (when the clock is set); the real-time counter; and the current channel number. During tape playback, press the EXIT/STATUS button repeatedly to see the real-time counter or the current time.

Line Input Mode Light

When L appears here, the VCR is in Line Input mode. When L-F appears, you have selected A/V IN FRONT. Your audio and video cables should be connected to the AUDIO/VIDEO jacks on the front of the VCR if you are dubbing tapes. When L-R appears here, you have selected A/V IN REAR. Your audio and video cables should be connected to the AUDIO/VIDEO jacks on the back of the VCR if you are dubbing tapes. To select A/V IN FRONT or A/V IN REAR, press 0,0, then press the CH(annel) ▲/▼ buttons so that A/V IN FRONT or A/V IN REAR appears on-screen briefly. To exit Line Input mode, press the Number buttons or the CH(annel) ▲/▼ buttons to select another channel.

PLAY Button

Press to play a tape. Also, press to release Slow, Still, or Search mode and return to normal playback. *Details are on pages 55- 56.*
Press and hold the PLAY ▲ button for at least five seconds to have the VCR play a tape repeatedly. *Details are on page 55.*

STOP/EJECT Button

Press once to stop the tape. When tape playback is stopped, press to eject the tape.

REC(ord)/OTR Button

Press once to record. *Details are on page 31.* Press repeatedly to start a One-Touch Recording. *Details are on page 32.*

POWER Button

Press to turn the VCR power on and off.

STILL/PAUSE Button

During tape playback, press once to freeze the picture. Press repeatedly to advance the Still picture frame by frame. *Details are on page 55.* During recording, press to temporarily stop the recording. Press a second time to resume recording. *Details are on page 31.*

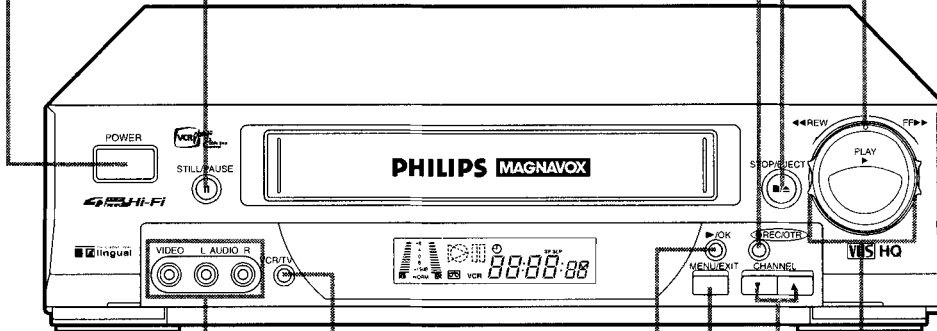

Front VIDEO/AUDIO In Jacks

Connect cables coming from the VIDEO and AUDIO OUT Jacks of another VCR or a cam-corder here. *Details are on page 48.*

VCR/TV Button

Press to select the signal that your TV receives.

VCR Position:

Use to watch a tape, to watch a program while recording it, or to watch a TV broadcast using the CH(annel) ▲/▼ or Number buttons to change channels at the VCR. The VCR light will appear on the display panel when the VCR is in VCR position.

TV Position:

Use to watch TV or to watch one program while recording another. *Details are on page 33.* The VCR light will not appear on the display panel when the VCR is in TV position.

►/OK Button

Press to change the setting of an on-screen menu item.

MENU/EXIT Button

Press to access the main VCR menu. Or, press to exit on-screen menus.

Shuttle Ring

Turn this ring in either direction for forward or reverse searching of a tape. The farther the ring is rotated, the faster the search speed. Releasing the ring stops the picture in the Still mode. *For details, see page 56.*

CHANNEL ▲/▼ Buttons

Press to scan through the VCR's channels. During tape playback, press to manually adjust the tracking. *Details are on page 57.* Press to select an item in the VCR's on-screen menu.

26 Rear Panel

AUDIO OUT Jacks

Connect cables going to the AUDIO IN jacks of a camcorder, another VCR, or an audio source here. Details are on pages 48 and 51.

CABLE BOX Jack

Connect the Controller here. You may use the Controller with either a Cable Box or a DBS. Details are on pages 43 - 47.

AUDIO IN Jacks

Connect cables coming from the AUDIO OUT jacks of a camcorder, another VCR, or an audio source here. Details are on page 48.

ANT(enna) IN Jack

Connect your antenna or cable here. Details are on pages six - nine.

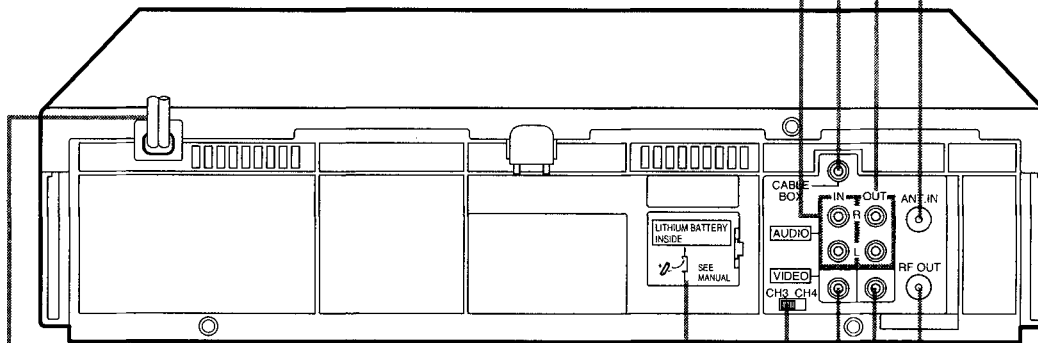

AC Power Cord

Connect to a wall outlet (120 V) to supply power to the VCR.

LITHIUM BATTERY compartment

Place the lithium battery here. Details are on page 10.

CH3/CH4 Switch

Set to channel 3 or 4 to use your TV with your VCR. Set your TV to the same channel. Details are on pages six - nine.

VIDEO IN Jack

Connect a cable coming from the VIDEO OUT jack of a camcorder or another VCR here. Details are on page 48.

VIDEO OUT Jack

Connect a cable going to the VIDEO IN jack of a camcorder or another VCR here. Details are on pages 48 and 51.

RF OUT Jack

Use the supplied RF coaxial cable to connect this jack to the ANTENNA IN Jack on your TV or to the IN Jack on your Cable Box/DBS (if applicable). Details are on pages six - nine.

On-Screen Status Displays 27

An on-screen status display, which includes the current time, channel, and other information (see illustration of the status display at right), will appear when you press the EXIT/STATUS button or certain function buttons. The contents of the status display may vary.

ON SCREEN MODE ON:

- Whenever you press the PLAY ▲ button or the STOP ▼ button to stop playback, some of the contents of the status display will appear for five seconds.

ON SCREEN MODE COUNTER:

- The real-time counter will appear on-screen at all times. Whenever you press the PLAY ▲ button or the STOP ▼ button to stop playback, some of the contents of the status display will appear for five seconds. After five seconds, only the counter will remain on the screen.

ON SCREEN MODE OFF:

- No status display will appear when you press function buttons or the EXIT/STATUS button.

To select a status display mode, follow these steps.

1

Press the VCR button, then press the MENU button.

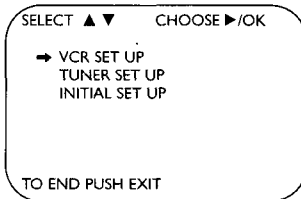

2

Press the PLAY ▲ or STOP ▼ button to select VCR SET UP, then press the FF ►/OK button.

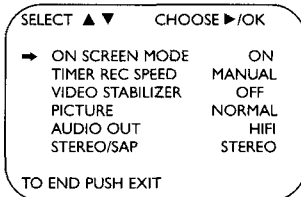

3

Press the PLAY ▲ or STOP ▼ button to select ON SCREEN MODE, if necessary.

4

Press the FF ►/OK button repeatedly so that ON, OFF, or COUNTER appears beside ON SCREEN MODE.

5

Press the EXIT/STATUS button.

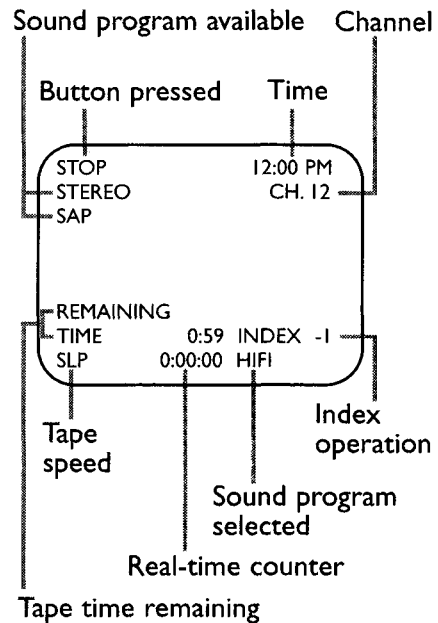

Helpful Hints

- If ON SCREEN MODE is set to ON or COUNTER:
 - You may bring up the status display at any time by pressing the EXIT/STATUS button. (The exception is during Slow, Search, or Still mode.) The display will appear for about five seconds.
 - Channel numbers (when tuned) will appear for a few seconds.
- When tape playback is stopped, press the EXIT/STATUS button repeatedly to see the current time, real-time counter, or current channel number on the display panel. During tape playback, press the EXIT/STATUS button repeatedly to see the current time or real-time counter on the display panel. The channel will not appear.
- Depending on the type of tape used, the tape time remaining may not appear right away, or may not be correct. Also, "--:--" may appear or the display may flash.

28 Setting the Remote Control to Operate a TV

Your VCR remote control may operate your TV. Follow these steps to set the remote control code.

1

Point the remote control at your TV. Press the **TV** button, then press the **POWER** button. If your TV turns on or off, try the CH(annel) ▲/▼ buttons. If your remote control operates the TV, you're finished. If your TV doesn't turn on or off, or if the CH(annel) ▲/▼ buttons don't work, go to step 2.

2

Find the brand of your TV on the list below, and remember the two-digit number beside it.

TV CODES	
EMERSON14	RCA10
GOLDSTAR04	SAMSUNG18
HITACHI12	SANYO11
JVC05	SHARP16
MAGNAVOX01, 02, 03	SONY09
MITSUBISHI13	TOSHIBA08
PANASONIC07, 17	ZENITH06, 15
PHILIPS01	
PHILIPS MAGNAVOX01, 02, 03	

3

While you press and hold the **TV** button, use two **Number** buttons to enter the two-digit code for your TV. For example, if you have a Zenith TV, press Number buttons 1, 5. Then still holding the **TV** button, press the **STOP ▼** button. Your TV may turn on or off automatically.

4

Repeat step 1.

If the remote control works your TV, you're finished. If the remote control still doesn't work your TV, repeat steps 2 - 3, using a different code for your brand (if available).

2

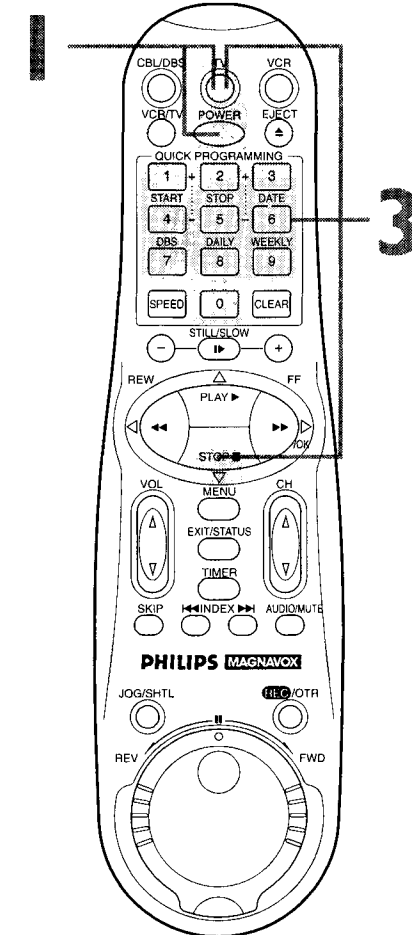
 Find the code for your TV.

Helpful Hints

- If you had to program the remote control to operate your TV, whenever you replace the batteries in the remote control, you will have to program the remote control again.
- There is no guarantee that the remote control will work your TV.

Setting the Remote Control to Operate a Cable Box/DBS 29

Your VCR remote control may operate your Cable Box/DBS. Follow these steps to set the remote control code.

1

Point the remote control at your Cable Box/DBS. Press the **CBL/DBS** button, then press the **POWER** button. If your Cable Box/DBS turns on or off, try the CH(annel) **▲/▼** buttons. If the remote control operates the Cable Box/DBS, you're finished. If your Cable Box/DBS does not turn on or off, or if the CH(annel) **▲/▼** buttons don't work, go to step 2.

2

Find the brand of your Cable Box/DBS on the list below and remember the two-digit number beside it.

CABLE BOX/DBS CODES	
ARCHER01, 05, 17	REGAL10, 18, 19, 23
CABLETENNA01, 17	REGENCY19
CABLEVIEW .15, 16, 17, 21, 25	REMBRANDT01, 16, 17
CITIZEN . . .15, 16, 17, 21, 25	SAMSUNG05, 16, 24
CURTIS02, 08	SCIENTIFIC ATLANTA .02, 08
DIAMOND01, 17	SIGMA07, 20
EASTERN19	SL MARX . . .05, 16, 17, 24, 25
GC BRAND .15, 16, 17, 21, 25	SPRUCER13, 14
GEMINI15	STARGATE . . .05, 15, 16, 17,
GENERAL INSTRUMENTS21, 24, 25
.01, 04, 06, 11, 12, 15	TELEVIEW05, 16, 24
HAMLIN10, 18, 19, 23	TOCOM01, 04, 16
JASCO15	UNIKA01, 17
JERROLD	UNIVERSAL . . .16, 17, 25
.01, 04, 06, 11, 12, 15	VIDEOWAY03, 09, 22
NOVAVISION02, 08	ZENITH03, 09, 22
OAK07, 20	
PANASONIC13, 14	MAGNAVOX DBS . . .42, 43
PULSAR . . .15, 16, 17, 21, 25	RCA DBS40, 44
RCA13, 14	SONY DBS41

3

While you press and hold the **CBL/DBS** button, use two **Number** buttons to enter the two-digit code for your **Cable Box/DBS**. For example, if you have a Zenith Cable Box, press Number buttons 0, 3. **Then, still holding the CBL/DBS button, press the STOP ▼ button.** (The Cable Box may shut off automatically.)

4

Repeat step 1. If the remote control still does not work on your Cable Box/DBS, repeat steps 2 - 3 using a different code for your brand.

2

Find the code for your Cable Box/DBS.

3

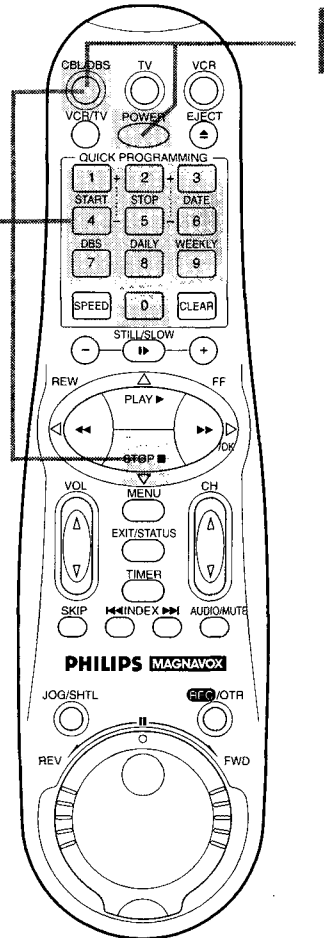

Helpful Hints

- If you had to program the remote control to operate your Cable Box/DBS, whenever you replace the batteries in the remote control, you must program the remote control again.
- The remote control may only operate some features of your Cable Box/DBS.
- Some Cable Boxes/DBSs can only be turned on at the Cable Box/DBS.
- There is no guarantee that the remote control will work your Cable Box/DBS.

30 Playing

Read and follow the steps below to play a tape.

1

Turn on the TV and set it to channel 3 or 4, whichever the CH3/CH4 switch on the back of the VCR is set to.

2

Insert a tape in the VCR. The power will come on. The VCR will place itself in VCR position automatically (the VCR light will appear on the display panel of the VCR). If the VCR light does not appear, press the VCR/TV button once. If the tape's record tab has been removed, playback will start automatically.

3

If playback does not start automatically, press the **PLAY** \blacktriangle button. The \blacktriangleright light will appear on the VCR display panel.

4

Press the **STOP** \blacktriangledown button to stop playback.

5

Press the **REW(ind)** \blacktriangleleft button to rewind the tape.

6

When the tape has finished rewinding, press the **EJECT** button to remove the tape.

1

Turn on the TV.

2

Insert a tape.

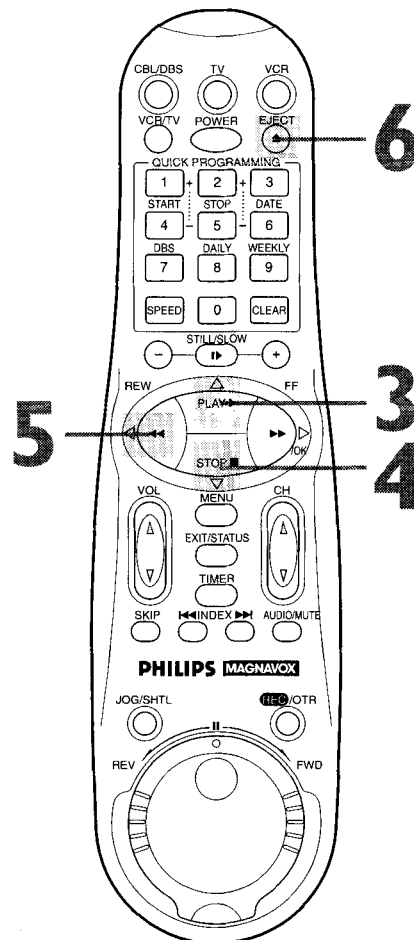

Helpful Hints

- Playback options and features are discussed on pages 50 - 57.
- This VCR is equipped with SQPB (S-VHS Quasi Playback) that lets you watch tapes recorded in the S-VHS format with regular VHS resolution.
 - SQPB does not deliver Super VHS resolution.
 - S-VHS recording is not possible with this VCR.

Recording 31

Read and follow the steps below to record a television program.

1

Turn on the TV and set it to channel 3 or 4, whichever the CH3/CH4 switch on the back of the VCR is set to.

2

Insert a tape with its record tab intact (details are on page 5) in the VCR. The power will come on.

3

Press the VCR button.

4

If the VCR light appears on the display panel of the VCR, go to step 5. If the VCR light does not appear, press the VCR/TV button once.

5

Press the SPEED button until the desired tape speed appears on-screen. The VCR will only record in SP or SLP. Details about tape speed are on pages 39 and 58.

6

Use the CH(annel) ▲/▼ buttons or the Number buttons to select the channel to be recorded.

7

Press the REC(ord)/OTR button to start recording. The ○ light will appear on the VCR display panel.

8

To pause the recording (for example, during commercials), press the STILL/SLOW button on the remote control. The ○□□ light will appear on the display panel.

To resume recording, press the STILL/SLOW button again. The ○ light will appear on the display panel.

9

Press the STOP ▼ button to stop recording. The ○ light will disappear from the display panel.

1 Turn on the TV.

2 Insert a tape.

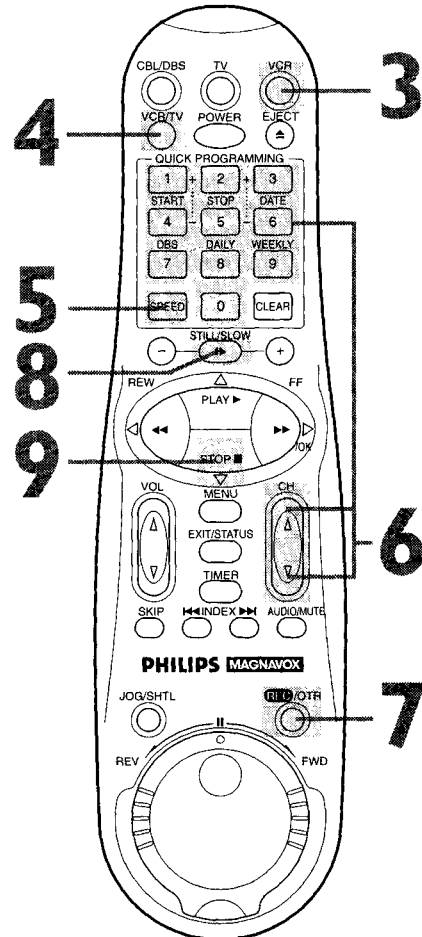

Helpful Hints

- If the REC(ord)/OTR button is pressed while a tape without a record tab is in the VCR, PROTECTED CASSETTE CANNOT RECORD will appear on-screen briefly. The VCR will eject the tape.
- The VCR records in a preset volume.
- If the end of the tape is reached while recording, the VCR will stop recording, rewind the tape, then stop. Details are on page 57.

32 One-Touch Recording

The One-Touch Recording (OTR) function allows you to start an immediate timed recording 30 minutes to nine hours long of the channel you are watching. Before you begin, make sure:

- Channels are set up. *Details are on pages 13 - 14.*
- The desired recording speed (SP or SLP) has been selected with the SPEED button. *Details are on pages 39 and 58.*
- There is a tape in the VCR. Make sure the tape's record tab is intact (see page 5) and the tape is long enough to record the program(s). If the end of the tape is reached during an OTR, recording will stop. The VCR will eject the tape and turn itself off.
- The VCR is in VCR position. (The VCR light will appear on the display panel of the VCR when the VCR is in VCR position. If the VCR light does not appear, press the VCR/TV button once.)

Starting an OTR

1

Press the **VCR** button.

2

Use the **CH(annel)** Δ/∇ buttons or the **Number** buttons to select the channel you want to record.

3

Press the **REC(ord)/OTR** button repeatedly until the desired recording length appears briefly on-screen and on the display panel. The \circ light will flash on the display panel.

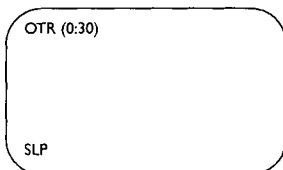

Stopping an OTR

To stop an OTR before recording is finished, press the **STOP** ∇ button.

To cancel the OTR but continue recording, press the **REC(ord)/OTR** button repeatedly until **REC** appears in the upper left corner of the TV screen. (ON SCREEN MODE cannot be set to OFF. *Details are on page 27.*) The \circ light will remain on the display panel.

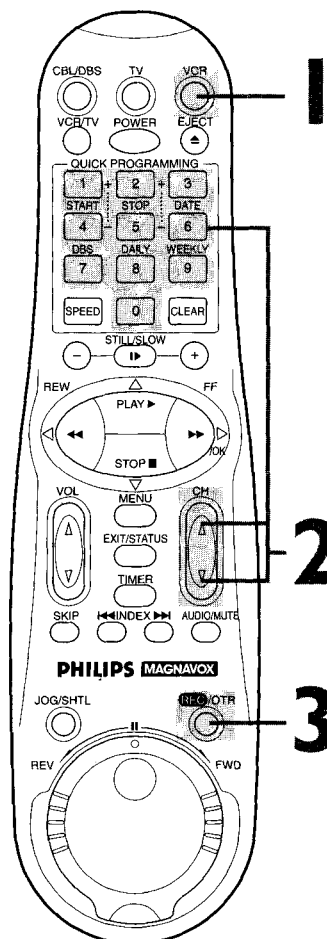

Helpful Hints

- To check the time remaining for an OTR after the OTR is in progress, press the **EXIT/STATUS** button.
- To change the recording length while an OTR is in progress, press the **REC(ord)/OTR** button until the desired length appears on-screen.
- If the preset time for a timer recording comes up during an OTR, the OTR has priority.

Recording One Channel/Watching Another 33

1

Press the VCR button.

2

Press the REC(ord)/OTR button to start a recording.

Details are on page 31.

3

Press the VCR/TV button to put the VCR in TV position.

The VCR light will disappear from the display panel.

4

Use the TV remote control to select the channel you want to watch. Or, if the VCR remote control operates your TV, press the TV button, then use the CH(annel) ▲/▼ buttons to select the channel you want to watch.

The channel selected with the TV controls will appear on-screen while the channel you previously selected to record is being recorded. (The ○ light will appear on the display panel.)

5

To return to the channel being recorded, use the TV remote control to select channel 03 or 04 (whichever channel the CH3/CH4 switch on the back of the VCR is set to).

Or, if the VCR remote control operates your TV, press the TV button, then use the CH(annel) ▲/▼ buttons to select channel 03 or 04.

6

Press the VCR button.

7

Press the VCR/TV button to put the VCR in VCR position.

(The VCR light will appear on the display panel.) The channel being recorded will appear on-screen.

8

To stop the recording, press the STOP ▼ button.

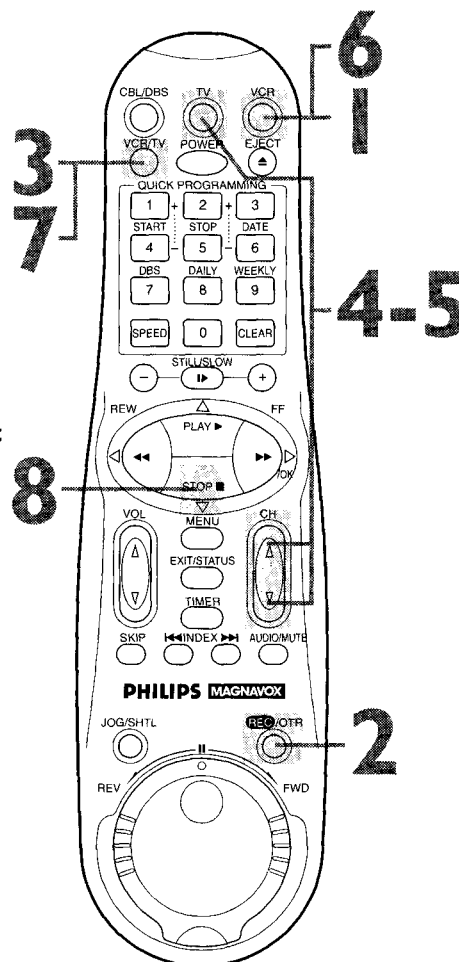

Helpful Hint

- If you use a Cable Box/DBS, you may not be able to watch one channel while recording another. See page nine for details.

34 Setting Up the VCR Plus+ Programming System

First, fill in the boxes on this page. It will only take a few minutes, and you must do it if you want the VCR Plus+ programming system to work properly.

Since the channel numbers of the stations you receive may not be the same as the station numbers, and since channel numbers differ from area to area, you must program the VCR with your local channel information. To fill in the boxes, you will need 1) a cable channel list, if applicable (you can request one from your cable company), and 2) a chart that lists VCR Plus+ channel numbers, which you can find in your TV guide or the TV listings of your local newspaper.

NOTE: If you are using a Cable Box/DBS, the Cable/TV channel must be one of 02 to 09 (the Cable Box output channel) or 03 or 04 (the DBS output channel) for every VCR Plus+ channel.

Channels		
Station Call Letters	VCR PLUS+ CH.	CABLE/TV CH.

Channels		
Station Call Letters	VCR PLUS+ CH.	CABLE/TV CH.

Setting Up the VCR Plus+ Programming System (cont'd) 35

2

Now, compare the channel numbers you have written into the VCR PLUS+ CH. and CABLE/TV CH. columns. You'll notice that some stations have VCR Plus+ and Cable/TV channel numbers that are the same, and other stations have channel numbers that do not match. You must tell the VCR the VCR Plus+ and Cable/TV channel numbers according to the following steps.

3

Press the **VCR** button, then press the **MENU** button.

4

Press the **PLAY** ▲ or **STOP** ▼ button to select **INITIAL SET UP**, then press the **FF** ►/OK button.

5

Press the **PLAY** ▲ or **STOP** ▼ button to select **VCR PLUS+ CH.**, then press the **FF** ►/OK button.

SET VCR PLUS+ CH.	VCR PLUS+	CABLE/TV
	99	---
	01	---
	02	---->
	03	---
	04	---
SELECT ▲▼ OR ENTER VCR+ CH. NO. THEN PUSH ►/OK TO END PUSH EXIT		

6

While the **VCR PLUS+** channel is flashing, press the **PLAY** ▲ or **STOP** ▼ button repeatedly or press the **Number** buttons to select a **VCR PLUS+** channel number. The arrow will appear beside the VCR PLUS+ channel. Press the **FF** ►/OK button.

7

While the space for the **CABLE/TV** channel is flashing, press the **PLAY** ▲ or **STOP** ▼ button repeatedly or press the **Number** buttons to enter the **CABLE/TV** channel number. Press the **FF** ►/OK button.

Repeat steps 6 - 7 until you have entered all the channels on your list.

8

Press the **EXIT/STATUS** button to exit.

2

Examine the lists on page 34.

3

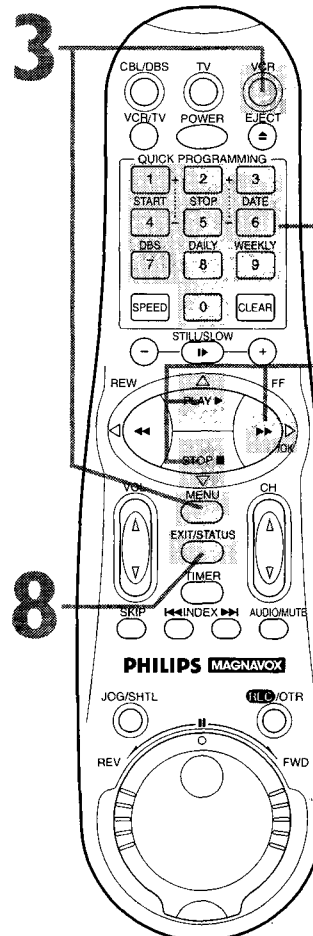

36 Timer Recording With the VCR Plus+ Programming System

Follow the steps below to program a timer recording using PlusCode programming numbers. Before you begin make sure:

- Channels are set up. *Details are on pages 13 - 14.*
- The clock is set. *Details are on pages 15 - 19.*
- There is a tape in the VCR. Make sure the tape's record tab is intact and the tape is long enough to record the program(s).
- The VCR is in VCR position (the VCR light will appear on the display panel). If the VCR light does not appear, press the VCR/TV button once.
- You have programmed the VCR Plus+ and Cable/TV channel numbers. *Details are on pages 34 - 35.*

Complete each step within 60 seconds of completing the previous step. If you don't, you may start again at step 1.

1

Press the **VCR** button.

2

Press the **TIMER** button.

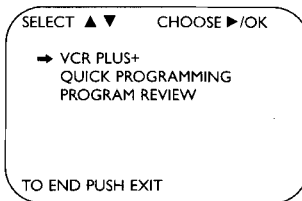

3

Press the **PLAY ▲** or **STOP ▼** button to select **VCR PLUS+**, then press the **FF ►/OK** button.

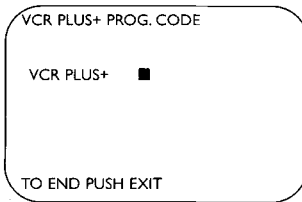

4

Use the **Number** buttons to enter the **PlusCode** programming number of the program you wish to record. (This number is different for every program, and it can be four to eight digits long.)

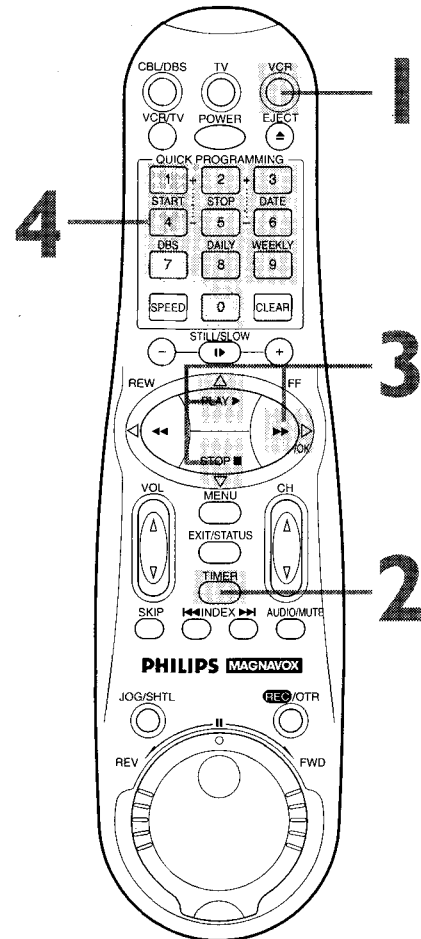
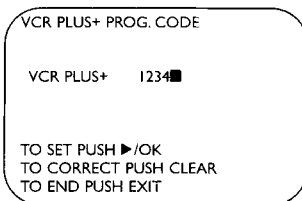

Helpful Hint

- If you enter an incorrect PlusCode programming number at step 4, **ERROR-RE-ENTER CODE** will flash on-screen. Enter the correct PlusCode programming number.

Timer Recording With the VCR Plus+ Programming System (cont'd) 37

5

Press the **FF ►/OK** button. If the VCR PLUS+ and CABLE/TV channel lists appear on-screen, the CABLE/TV channel has not been set for the VCR PLUS+ channel of the program you have set in step 4. Complete step 7 on page 35.

6

- If you want to record the program one time only, go to step 7. You may also press the Number 8/DAILY or 9/WEEKLY button repeatedly to select a ONE TIME PROGRAM.
- If you want to record the program daily, press the Number 8/DAILY button. The VCR will record a program every day from Monday through Friday, starting at the same time and recording for the same length of time.
- If you want to record the program every week, press the Number 9/WEEKLY button. The VCR will record a program on the same day, at the same time, for the same length of time every week.

DAILY PROGRAM (MON-FRI)
PROGRAM 1
CHANNEL +/- 12
START +/- 08:00 PM
STOP +/- 10:00 PM
REC SPEED SP
DATE +/- 07/31/98
FRIDAY
SET DAILY=8 OR WEEKLY=9
TO END PUSH EXIT

7

Press the **SPEED** button to select the tape speed. The selected tape speed, SP or SLP, will appear beside REC SPEED.

8

Press the **EXIT/STATUS** button. PROGRAM WAS COMPLETED/PLEASE TURN OFF VCR FOR TIMER RECORDING should appear on the screen. (If PROGRAM NOT COMPLETED appears, begin again from step 1.) After five seconds, the on-screen display will disappear.

9

Press the **POWER** button to turn off the VCR. The VCR must be turned off for a timer recording to take place. The \odot light will appear on the display panel. The \ominus light and the Cassette-Inside light will flash when you turn off the VCR if there is not a tape in the VCR.

**The VCR must be turned off for a timer recording to take place!
Make sure a tape is in the VCR.**

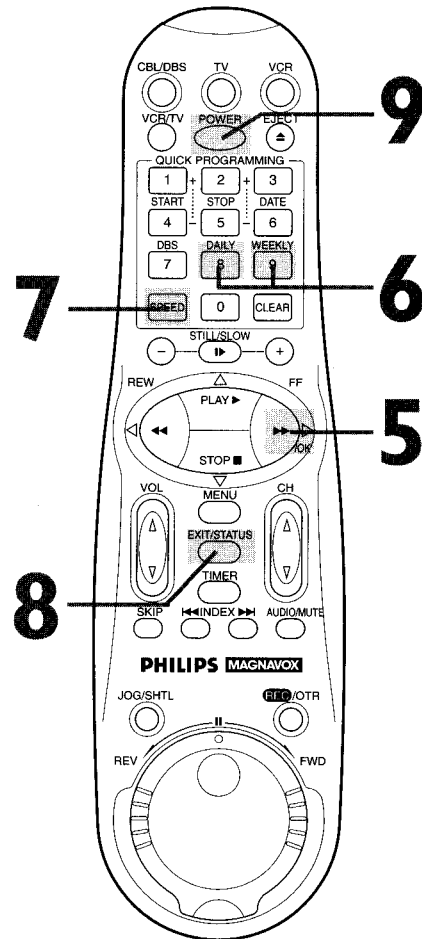

Helpful Hints

- Do not select DAILY at step 6 if the VCR Plus+ recording you chose is on a Saturday or Sunday. The recording will not occur, even though the VCR may accept the way you programmed the recording.
- To exit the VCR Plus+ programming system at any step, press the EXIT/STATUS button.
- PROGRAM NOT COMPLETED/CLASH may appear on-screen for five seconds at step 8 if the timer recording you programmed overlaps with another timer recording. To cancel the overlapping timer recording, follow the steps on page 41.
- If you want to check your timer recordings, follow the steps on page 41.

38 Quick Programming

Follow the steps below to program your VCR to record TV programs while you're away from home. The VCR will turn itself on, record, and turn itself off automatically.

Before you begin make sure:

- Channels are programmed. *Details are on pages 13 - 14.*
- The clock is set. *Details are on pages 15 - 19.*
- There is a tape in the VCR. Make sure the tape's record tab is intact and the tape is long enough to record the program(s).
- The VCR is in VCR position. The VCR light will appear on the display panel when the VCR is in VCR position. If the VCR light does not appear, press the VCR/TV button once.
- When you use a Cable Box/DBS, timer recordings are programmed differently. Read pages 8 - 9 before proceeding.
- Complete each step within 60 seconds of the previous step.

1 Press the **VCR** button, then press the **TIMER** button.

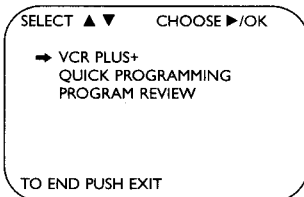

2

Press the **PLAY ▲** or **STOP ▼** button to select **QUICK PROGRAMMING**, then press the **FF ►/OK** button.

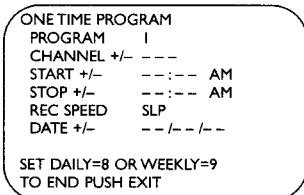

3

Press the **CH(annel) ▲/▼** buttons to enter the channel you want to record.

- If you are using a standard antenna or cable to VCR to TV hookup (as shown on pages 6 - 7), enter the channel of the TV program you want to record.
- If you are using the Controller, enter the Cable Box/DBS channel you want to record. If you are not using the Controller, enter the Cable Box output channel (one of channels 02 to 09) or the DBS output channel (03 or 04), then select the channel to be recorded at the Cable Box/DBS. Leave the Cable Box/DBS on for the timer recording.

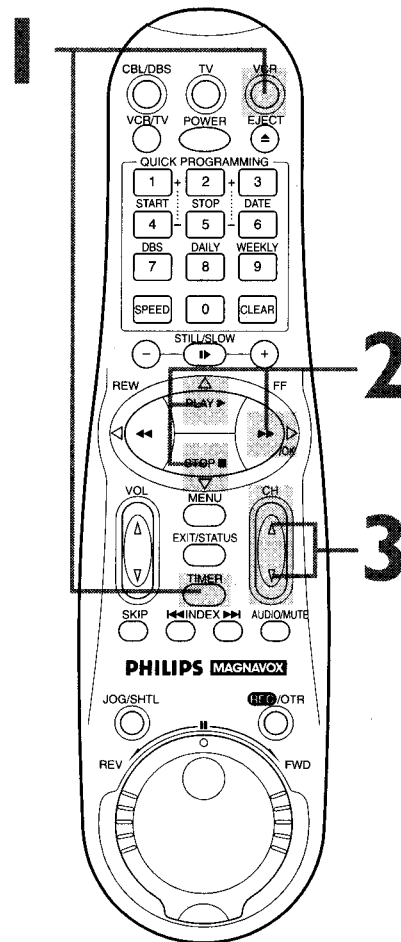
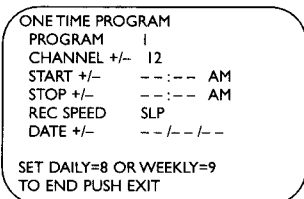

4

Press the Number 1/START + or Number 4/START- button to set the recording's start time. Every time you press a button, the start time changes in one-minute increments. If you press and hold a button, the start time changes in 30-minute increments.

```
ONE TIME PROGRAM
PROGRAM 1
CHANNEL +/- 12
START +/- 08:00 PM
STOP +/- ---:-- AM
REC SPEED SLP
DATE +/- --/--/--
```

SET DAILY=8 OR WEEKLY=9
TO END PUSH EXIT

5

Press the Number 2/STOP+ or Number 5/STOP- button to set the recording's stop time. Every time you press a button, the stop time changes in one-minute increments. If you press and hold a button, the stop time changes in 30-minute increments.

```
ONE TIME PROGRAM
PROGRAM 1
CHANNEL +/- 12
START +/- 08:00 PM
STOP +/- 10:00 PM
REC SPEED SLP
DATE +/- --/--/--
```

SET DAILY=8 OR WEEKLY=9
TO END PUSH EXIT

6

Press the SPEED button to select the tape speed (SP or SLP). Details about tape speed are given below.

```
ONE TIME PROGRAM
PROGRAM 1
CHANNEL +/- 12
START +/- 08:00 PM
STOP +/- 10:00 PM
REC SPEED SLP
DATE +/- --/--/--
```

SET DAILY=8 OR WEEKLY=9
TO END PUSH EXIT

Instructions continue on page 40.

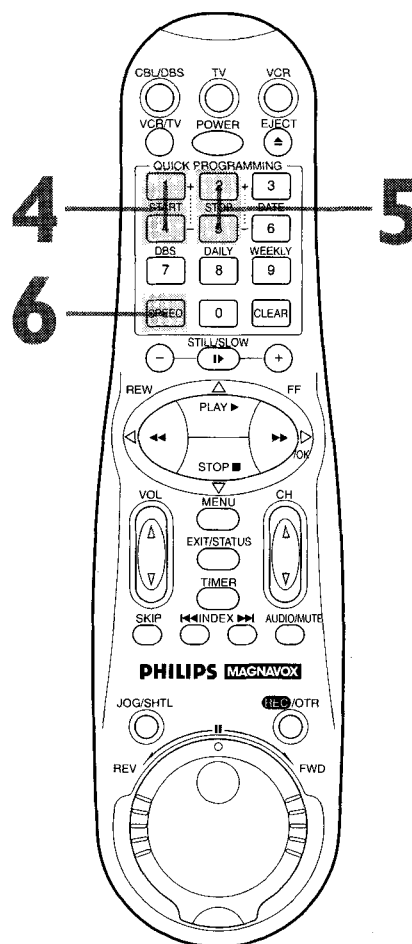

Helpful Hints

- If the preset time for a timer recording comes up during a One-Touch Recording, the OTR has priority.
- If the end of the tape is reached during a timer recording, recording will stop. The VCR will eject the tape, then turn itself off.

Tape Speed	Maximum Record/Playback Time		
	T160	T120	T60
SP (Standard Play)	2 hrs. 40 mins.	2 hrs.	1 hr.
LP (Long Play)	5 hrs. 20 mins.	4 hrs.	2 hrs.
SLP (Super Long Play)	8 hrs.	6 hrs.	3 hrs.

40 Quick Programming (cont'd)

7

Press the Number 3/DATE+ or Number 6/DATE- button to set the recording date. Every time you press a button, the date changes in one-day increments. If you press and hold a button, the date changes quickly. The day of the week will appear automatically. (You cannot program the VCR to record more than one year in advance.)

ONE TIME PROGRAM
PROGRAM 1
CHANNEL +/- 12
START +/- 08:00 PM
STOP +/- 10:00 PM
REC SPEED SLP
DATE +/- 07/31/98
FRIDAY
SET DAILY=8 OR WEEKLY=9
TO END PUSH EXIT

8

- If you want to record the program one time only, go to step 9. You may also press the Number 8/DAILY or 9/WEEKLY button repeatedly to select a ONE TIME PROGRAM.
- If you want to record the program daily, press the Number 8/DAILY button. The VCR will record a program every day from Monday through Friday, starting at the same time and recording for the same length of time.
- If you want to record the program every week, press the Number 9/WEEKLY button. The VCR will record a program on the same day at the same time and for the same length of time every week.

DAILY PROGRAM (MON-FRI)
PROGRAM 1
CHANNEL +/- 12
START +/- 08:00 PM
STOP +/- 10:00 PM
REC SPEED SLP
DATE +/- 07/31/98
FRIDAY
SET DAILY=8 OR WEEKLY=9
TO END PUSH EXIT

9

Press the EXIT/STATUS button. PROGRAM WAS COMPLETED/PLEASE TURN OFF VCR FOR TIMER RECORDING will appear on-screen. If PROGRAM NOT COMPLETED appears, try again from step 1.

10

Press the POWER button to turn off the VCR. The \odot light will appear on the display panel. (The \odot light and the Cassette-Inside light will flash when you turn off the VCR if there is not a tape in the VCR.) The VCR must be turned off for a timer recording to take place. If you forget to turn off the VCR, PLEASE TURN OFF VCR FOR TIMER RECORDING flashes on your TV screen two minutes before a timer recording starts. To remove the message, press the CLEAR button.

If a power failure occurs, programmed timer recordings will be saved if you have installed a fresh lithium battery in the VCR.

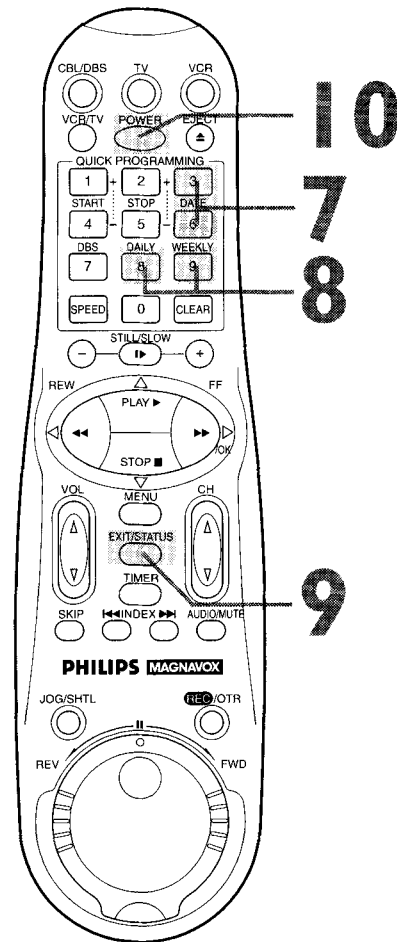

Helpful Hints

- If you leave the VCR on past the scheduled start time of a timer recording, you will not be asked again to turn off the VCR. When you turn off the VCR, the timer recording will not take place. The VCR may reprogram the recording for the same day and time in the next year.
- If PROGRAM NOT COMPLETED/CLASH appears at step 9, the timer recording you just programmed overlaps another timer recording. The timer recording you just programmed will not take place. The timer recording menu will reappear. To cancel a timer recording, see page 41.

Quick Programming (cont'd) 41

Checking, Editing, or Clearing Timer Recordings

1 Press the **VCR** button, then press the **TIMER** button.

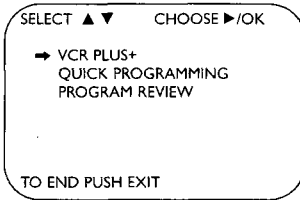

2

Press the **PLAY ▲** or **STOP ▼** button to select **PROGRAM REVIEW**, then press the **FF ►/OK** button. The list of programmed timer recordings will appear.

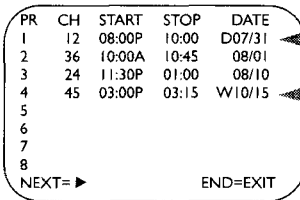

3

Press the **FF ►/OK** button. Information for the first program will appear. (If no timer recordings are set, **NO PROGRAM SET** will appear briefly.)

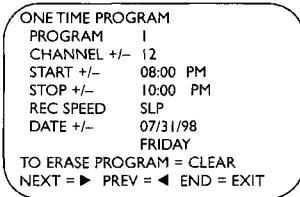

4

Press the **FF ►/OK** button repeatedly to review all programmed timer recordings. Or, press the **REW(ind) ◀** button to return to the previous screen.

5

You may change any of the information, except the program number. Follow the steps on pages 38 - 40.

6

To cancel the timer recording, press the **CLEAR** button. You will either see the next timer recording or the menu will disappear.

7

Press the **EXIT/STATUS** button.

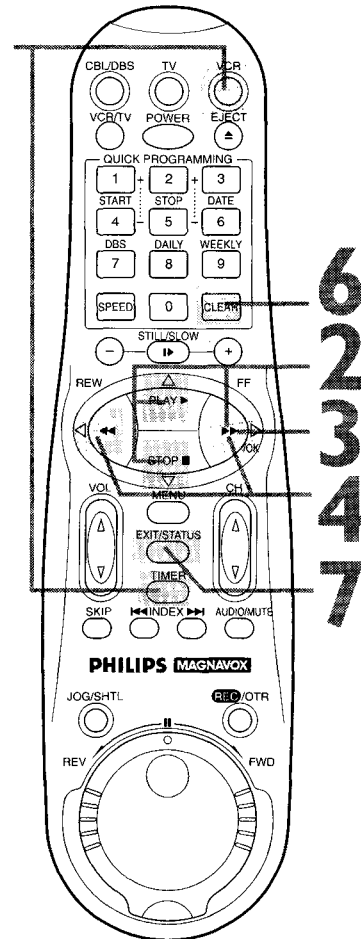

Helpful Hint

- To stop a started timer recording, press the **POWER** button on the VCR.

See pages 60 - 61 for more hints.

42 Timer Recording Speed Setting

If a program is recorded in SP and there is not enough tape to record the entire program, the VCR automatically switches to SLP to allow complete recording if **TIMER REC SPEED** is set to **AUTO**. This feature is especially useful when you record a program that is more than 2 hours long.

For example, to record a program of 140 minutes in length onto a 120-minute tape, the program is recorded in SP for about 110 minutes and in SLP for about 30 minutes.

Approximately 110 minutes	Approximately 30 minutes
SP	SLP

Follow the steps below to set **TIMER REC SPEED** to **AUTO**.

1

Press the **VCR** button, then press the **MENU** button.

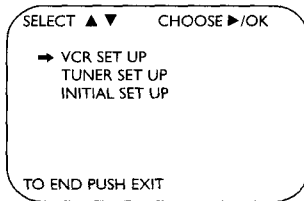

2

Press the **PLAY ▲** or **STOP ▼** button to select **VCR SET UP**, then press the **FF ►/OK** button.

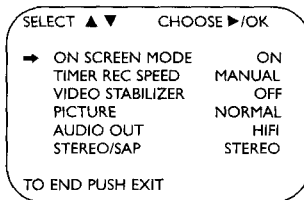

3

Press the **PLAY ▲** or **STOP ▼** button to select **TIMER REC SPEED**, then press the **FF ►/OK** button so that **AUTO** appears beside **TIMER REC SPEED**. (To turn off this feature, press the **FF ►/OK** button so that **MANUAL** appears beside **TIMER REC SPEED**.)

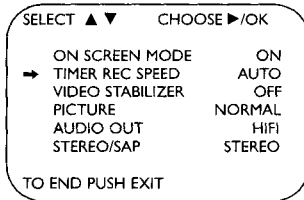

4

Press the **EXIT/STATUS** button.

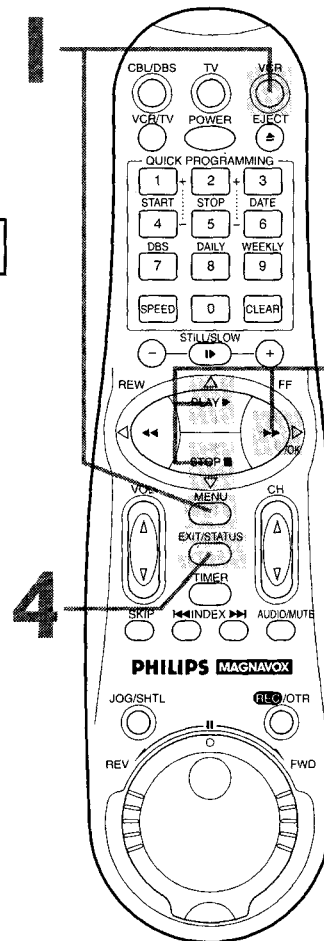

Connecting the Controller 43

.....
If you are using a Cable Box/DBS, connect the Controller to your VCR. The Controller will automatically select channels at the Cable Box/DBS during a timer recording. Leave your Cable Box/DBS turned on during a timer recording.

1
Connect the Cable Box/DBS to the VCR as shown below. For more information, please read page 8. Or, refer to the owner's manual of your Cable Box/DBS.

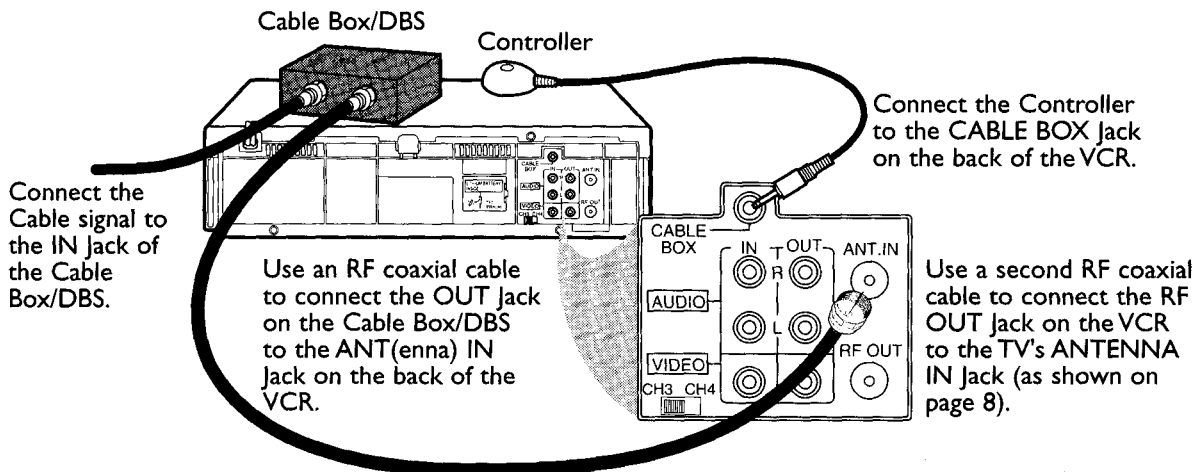

2

Connect the Controller to the CABLE BOX Jack on the back of the VCR as shown above.

3

Attach the Controller to the top of the VCR using adhesive tape. Make sure the Controller's transmitter (the light on the top of the Controller) is pointed toward the Cable Box/DBS remote sensor.

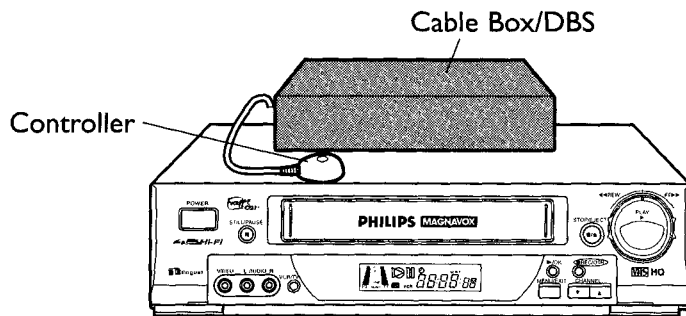

4

If you are using a Cable Box, follow the steps on pages 44 - 45 to make the Controller change channels at the Cable Box during timer recordings.

If you are using a DBS, follow the steps on pages 46 - 47 to make the Controller change channels at the DBS during timer recordings.

44 Setting the Controller to Operate a Cable Box

- If you use a Cable Box, you must set the clock manually. Details are on pages 15 - 16.
- Complete the steps on page 29 before proceeding. This will enable you to use the VCR remote control to operate the Cable Box, and you will learn your Cable Box code.
- Make each entry within one minute of the previous entry.

1
Turn on the Cable Box. Select a channel other than 09.

2
Press the VCR button, then press the MENU button.

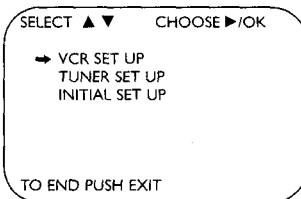

3
Press the PLAY ▲ or STOP ▼ button to select INITIAL SET UP, then press the FF ►/OK button.

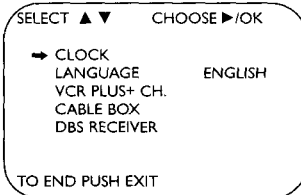

4
Press the PLAY ▲ or STOP ▼ button to select CABLE BOX, then press the FF ►/OK button.

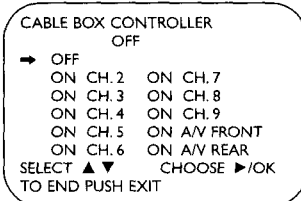

5
Press the PLAY ▲ or STOP ▼ button to select the output channel, then press the FF ►/OK button. The display shown below will appear. If CABLE BOX USERS SET CLOCK MANUALLY appears, follow steps 4 - 7 on page 16, then go to step 6 on page 45.

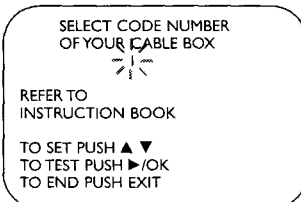

1 Turn on the Cable Box. Set it to a channel other than channel 09.

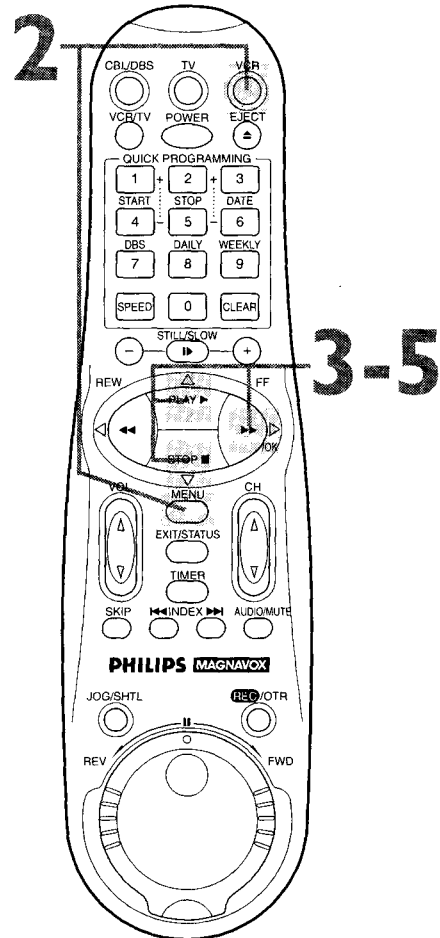

Helpful Hint

- If the EXIT/STATUS button is pressed during steps 5 - 8, "CABLE BOX CONTROL IS OFF" will appear on-screen for five seconds.

Setting the Controller to Operate a Cable Box (cont'd) 45

6

Press the **PLAY ▲** or **STOP ▼** button to set the code for your Cable Box (see list below), then press the **FF ►/OK** button.

SELECT CODE NUMBER
OF YOUR CABLE BOX
12

DID CABLE BOX DISPLAY
CHANGE TO CHANNEL 09?
→ YES
→ NO

TO CONTINUE PUSH ►/OK
TO END PUSH EXIT

CABLE BOX CODES	
ARCHER01, 05, 17	REGAL10, 18, 19, 23
CABLETENNA01, 17	REGENCY19
CABLEVIEW .15, 16, 17, 21, 25	REMBRANDT01, 16, 17
CITIZEN . . .15, 16, 17, 21, 25	SAMSUNG05, 16, 24
CURTIS02, 08	SCIENTIFIC ATLANTA .02, 08
DIAMOND01, 17	SIGMA07, 20
EASTERN19	SL MARX . . .05, 16, 17, 24, 25
GC BRAND .15, 16, 17, 21, 25	SPRUCER13, 14
GEMINI15	STARGATE . . .05, 15, 16, 17,
GENERAL INSTRUMENTS21, 24, 25
.01, 04, 06, 11, 12, 15	TELEVIEW05, 16, 24
HAMLIN10, 18, 19, 23	TOCOM01, 04, 16
JASCO15	UNIKA01, 17
JERROLD	UNIVERSAL16, 17, 25
.01, 04, 06, 11, 12, 15	VIDEOWAY03, 09, 22
NOVAVISION02, 08	ZENITH03, 09, 22
OAK07, 20	
PANASONIC13, 14	
PULSAR . . .15, 16, 17, 21, 25	
RCA13, 14	

7

Wait for a few seconds.

- If the Cable Box changes to channel 09, go to step 8.
- If the Cable Box doesn't change to channel 09, press the **PLAY ▲** or **STOP ▼** button to select NO, then press the **FF ►/OK** button. Repeat steps 6 - 7 using a different code for your brand.

8

Press the **PLAY ▲** or **STOP ▼** button to select YES, then press the **FF ►/OK** button. "CABLE BOX CONTROL IS ON" will appear for five seconds. If one of the output channels 02 through 09 is selected, "AS A RESULT AUTO CLOCK WILL BE TURNED OFF" also will appear on-screen.

7

Wait for a few seconds.

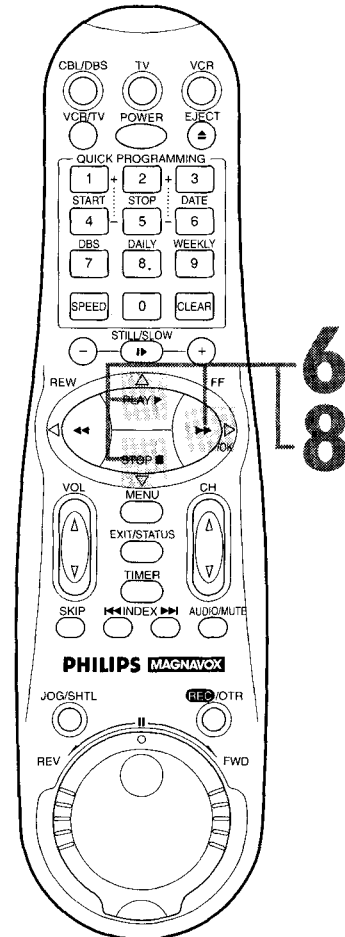

Helpful Hints

- If your Cable Box does not respond to any of the codes at step 7, the Controller will not change channels at the Cable Box during a timer recording. You must select the channel to be recorded at the Cable Box before a timer recording begins. Enter the Cable Box output channel (02 - 09) at step 3 on page 38. Leave the Cable Box on for the timer recording. See pages eight - nine for details. You may want to exchange your current Cable Box for one that can be controlled by the VCR's Controller.
- The Controller can change channels at the Cable Box only during a timer recording.

46 Setting the Controller to Operate a DBS

- If you use a DBS, you must set the clock manually. Details are on pages 15 - 16.
- Complete the steps on page 29 before proceeding. This will allow you to use the VCR remote control to operate the DBS, and you will learn your DBS code.

1
Turn on the DBS. Select a channel other than 205.

2
Press the VCR button, then press the MENU button.

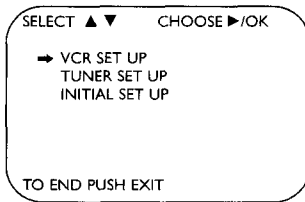

3
Press the PLAY ▲ or STOP ▼ button to select INITIAL SET UP, then press the FF ►/OK button.

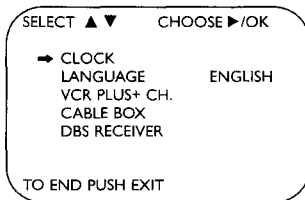

4
Press the PLAY ▲ or STOP ▼ button to select DBS RECEIVER, then press the FF ►/OK button.

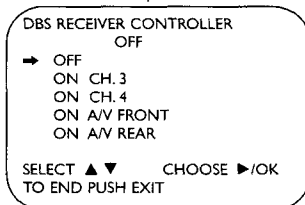

5
Press the PLAY ▲ or STOP ▼ button to select the output channel, then press the FF ►/OK button. The display shown below will appear. If DBS RECEIVER USERS SET CLOCK MANUALLY appears, follow steps 4 - 7 on page 16, then go to step 6 on page 47.

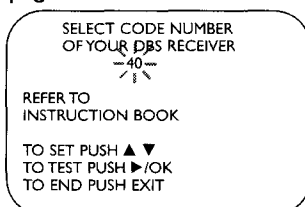

1 Turn on the DBS. Select a channel other than 205.

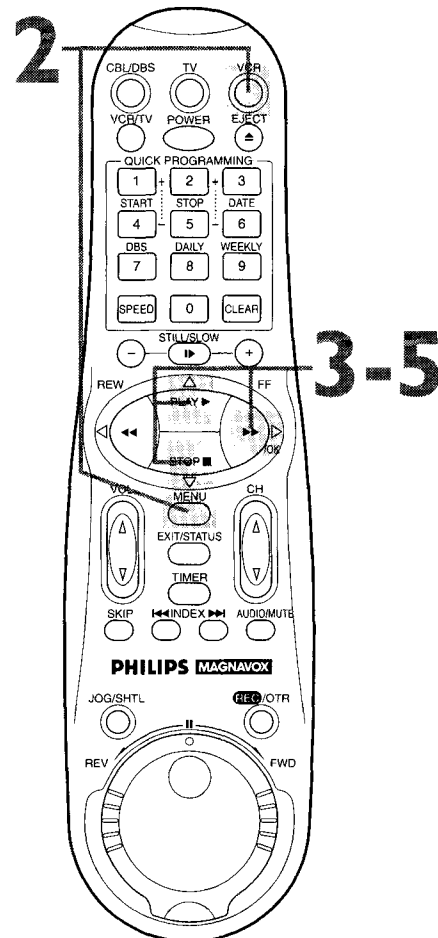

Helpful Hint

- The Controller can change channels at the DBS only during a timer recording.

Setting the Controller to Operate a DBS (cont'd) 47

6

Press the **PLAY ▲** or **STOP ▼** button to set the two-digit code for your DBS (see list below), then press the **FF ►/OK** button.

SELECT CODE NUMBER
OF YOUR DBS RECEIVER
40

DID DBS RECEIVER
CHANGE TO CHANNEL 205?
→ YES
→ NO

TO CONTINUE PUSH ►/OK
TO END PUSH EXIT

DBS CODES	
MAGNAVOX DBS	42, 43
RCA DBS	40
SONY DBS	41

7

Wait for a few seconds.

- If the Cable Box changes to channel 205, go to step 8.
- If the Cable Box doesn't change to channel 205, press the **PLAY ▲** or **STOP ▼** button to select **NO**, then press the **FF ►/OK** button. Repeat steps 6 - 7, using a different code for your brand (if available). If the DBS doesn't change to channel 205, the Controller will not operate your DBS. Press the **EXIT/STATUS** button. **DBS RECEIVER CONTROL IS OFF** will appear on-screen briefly.

8

Press the **PLAY ▲** or **STOP ▼** button to select **YES**, then press the **FF ►/OK** button. "DBS RECEIVER CONTROL IS ON" will appear for five seconds. The screen will return to the program you were watching. If the output channel 03 or 04 is selected, "AS A RESULT AUTO CLOCK WILL BE TURNED OFF" will appear on-screen also.

7

Wait for a few seconds.

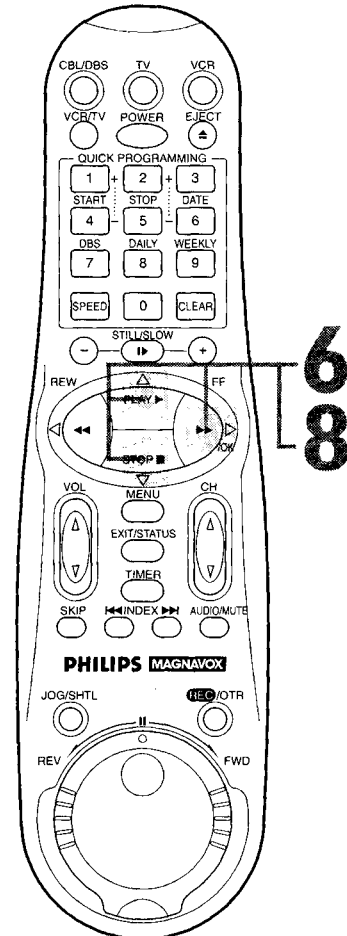

Helpful Hint

- If your DBS does not respond to the code in steps 6 - 7, the Controller will not change channels at the DBS during a timer recording. In this case, you must select the channel to be recorded at the DBS before a timer recording begins. Enter the DBS output channel (03 or 04) at step 3 on page 38. Leave the DBS on for the timer recording. Details are on page eight.

48 Rerecording (Tape Duplication)

The instructions on this page show you how to copy tapes. The illustration uses two VCRs just like yours. Different VCRs may operate differently. To duplicate a tape, make the connections shown, then follow steps 1 - 6. (You may use the AUDIO and VIDEO In jacks on the front of VCR 2 instead if you prefer.)

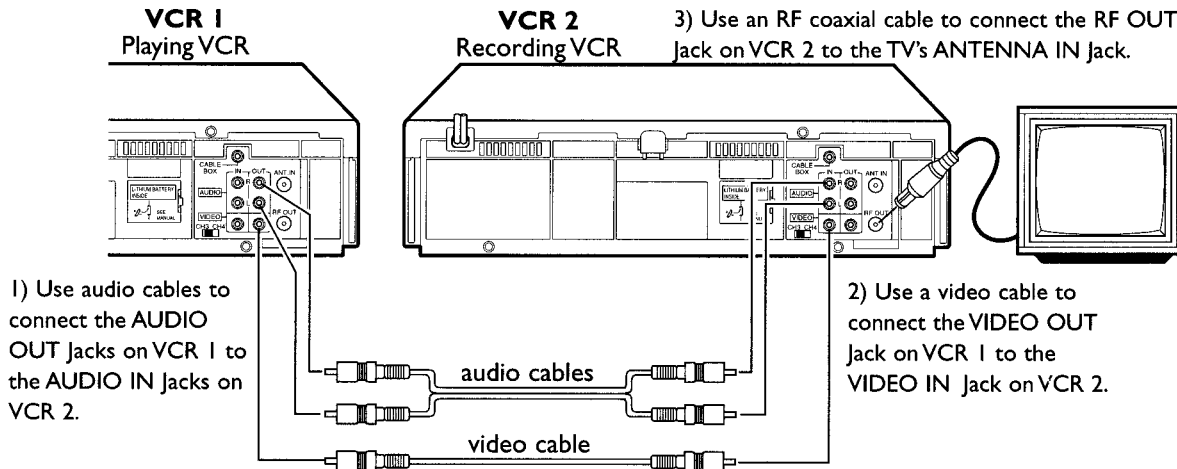

1

VCR 1 will play your tape. **Insert a prerecorded tape in VCR 1.** If the tape does not have a record tab, playback begins. If this happens, press the STOP/EJECT button on VCR 1 once.

2

VCR 2 will record your tape. **Insert a blank tape in VCR 2. Make sure the VCR power is on and the VCR is in VCR position.** (The VCR light will appear on the display panel. If it does not, press the VCR/TV button once.)

3

Turn on the TV; set it to channel 3 or 4, whichever channel the CH3/CH4 switch on VCR 2 is set to.

4

Point the remote control at VCR 2. Press the VCR button, then press the Number buttons 0, 0. L-1 will appear on the display panel.

5

Point the remote control at VCR 2. Press the SPEED button to select SP or SLP.

6

Press the PLAY button on VCR 1 and the REC(ord)/OTR button on VCR 2 at the same time. The \odot light will appear on the VCR 2 display panel.

Helpful Hints

- *Unauthorized recording of copyrighted television programs, video tapes, or other materials may infringe on the rights of copyright owners and violate copyright laws.*
- *Audio and video cables are not included.*
- *To stop copying tapes, press the STOP/EJECT button on VCR 2, then press the STOP/EJECT button on VCR 1.*
- *If you connect the audio and video cables to the AUDIO/VIDEO In jacks on the front of VCR 2, you must select A/V IN FRONT at step 4. To do so, press Number buttons 0,0, then press the CH(annel) \blacktriangledown button so that L-F appears on the display panel. A/V IN FRONT will appear on-screen if you press the STATUS/EXIT button. (ON SCREEN MODE cannot be set to OFF.)*

When you make a recording, the VCR automatically places an index code at the beginning of the recording. Essentially, an index code is a type of "bookmark" for your tape. This feature is useful if you have several different programs recorded on a single tape.

Fast forward or rewind to the next or previous index code on the tape by following the steps below.

1
Press the **VCR** button.

2
Make sure the VCR is in VCR position. (The VCR light will appear on the display panel when the VCR is in VCR position.) **If the VCR light does not appear, press the VCR/TV button once.**

3
Insert a tape in the VCR.

4
Press the **STOP** ▽ button to stop tape playback, if necessary.

5
Press the **INDEX** ►► button to fast forward to the next index code on the tape. Or, press the **INDEX** ◄◄ button to rewind to the previous index code on the tape. Wait for the VCR to fast forward or rewind the tape. When the index code is reached, tape playback will begin automatically.

NOTE: You may press an INDEX button repeatedly to skip over multiple recordings. For example, if you want to fast forward past four recordings, press the INDEX ►► button four times. INDEX 4 will appear in the bottom right corner of the screen. The index codes will count down on-screen as the search progresses. (ON SCREEN MODE cannot be set to OFF.)

3 Insert a tape.

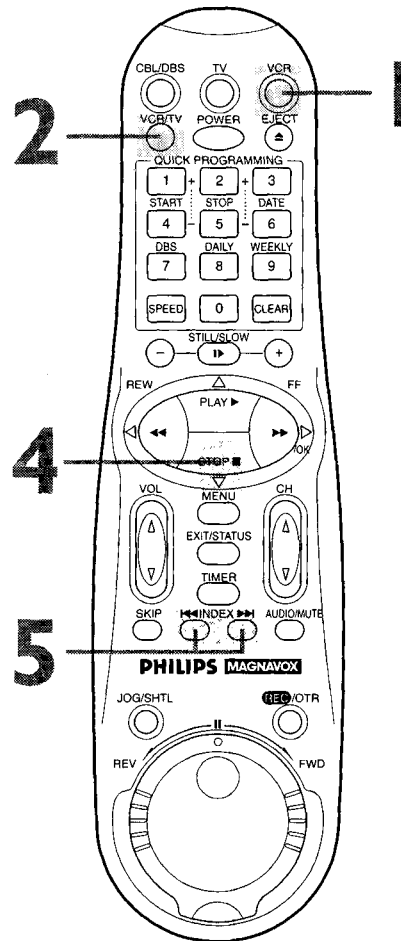

Helpful Hints

- The VCR does not place an index code at the point where a recording is paused, then resumed.
- INDEX may flash on-screen briefly when you begin a recording.

50 Multi-Channel Television Sound System

Your VCR can receive and record programs broadcast in stereo or second audio. It can also play back tapes recorded in stereo or second audio.

- **Second Audio** You can program your VCR so that you can hear a program that is being broadcast in second audio or a tape that was recorded in second audio. (A second audio broadcast is usually a program in a second language.) Follow the steps on page 51 to receive or record this type of program.
- **Hi-Fi Stereo Playback** If a tape is recorded in stereo, you can program your VCR to play a tape in Hi-Fi (high fidelity) stereo. Follow the steps on page 52.
- **Hi-Fi Stereo Recording** If a TV program is broadcast in stereo, you can program your VCR to receive and record the program in Hi-Fi stereo. You must program the VCR and make the appropriate stereo hookups. Follow the steps on page 51. To playback this type of program, follow the steps on page 52.

Receiving a Stereo Broadcast

When a TV program is being broadcast in stereo, STEREO will appear in the status display. You still have to program your VCR to receive and record the stereo broadcast. Follow the steps on page 51.

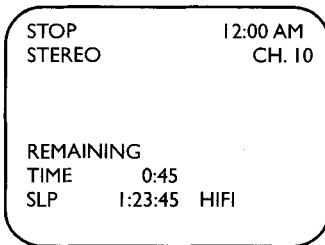

Receiving a Second Audio Program

If a program is being broadcast in second audio, SAP (Second Audio Program) will appear in the status display. You still have to program your VCR to receive and record the second audio program. Follow the steps on page 51.

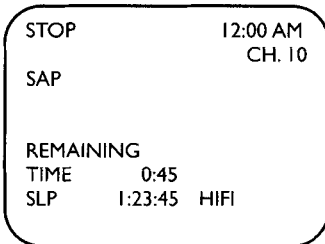

Multi-Channel Television Sound System (cont'd) 51

To receive and record programs broadcast in second audio, follow steps 1 - 6. To record a program broadcast in stereo, make one of the connections shown, then follow steps 1 - 6.

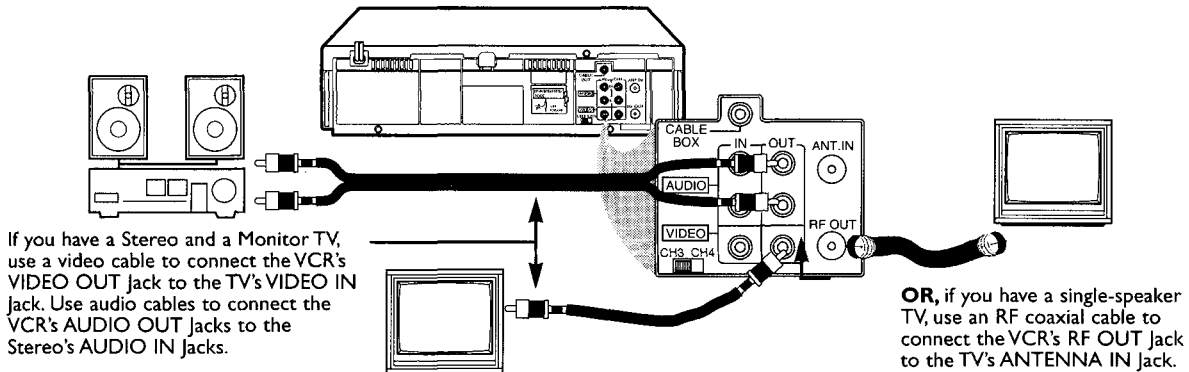

1
Press the **VCR** button, then press the **MENU** button.

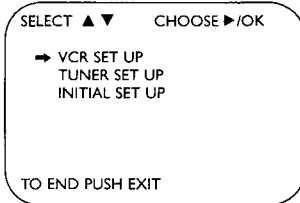

2
Press the **PLAY ▲** or **STOP ▼** button to select **VCR SET UP**, then press the **FF ►/OK** button.

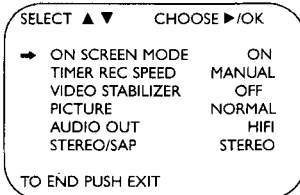

3
Press the **PLAY ▲** or **STOP ▼** button to select **STEREO/SAP**, then press the **FF ►/OK** button to set it to **SAP** (for a Second Audio Program) or **STEREO**, whichever you prefer.

4
Press the **EXIT/STATUS** button to exit.

5
Use the **CH(annel) ▲/▼** buttons to select a channel to record.

6
Press the **REC(ord)/OTR** button to start recording.

Helpful Hints

- If you want to connect the VCR to a Stereo TV, follow these steps.
 - 1) Connect the antenna or cable signal to the VCR's ANT(enna) IN Jack.
 - 2) Use stereo audio cables to connect the VCR's AUDIO OUT Jacks to the TV's AUDIO IN Jacks.
 - 3) Use a video cable to connect the VCR's VIDEO OUT Jack to the TV's VIDEO IN Jack.
- Make sure the TV and the Stereo (if applicable) are in Line Input or Auxiliary mode. Please refer to your TV or Stereo owner's manual for details.

52 Hi-Fi Stereo Tape Playback

If a tape is recorded in Hi-Fi stereo, follow the steps below to play the tape in Hi-Fi stereo.

1 Press the **VCR** button, then press the **MENU** button.

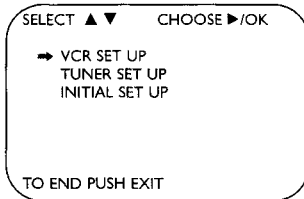

2

Press the **PLAY ▲** or **STOP ▼** button to select **VCR SET UP**, then press the **FF ►/OK** button.

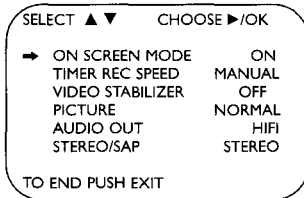

3

Press the **PLAY ▲** or **STOP ▼** button to select **AUDIO OUT**, then press the **FF ►/OK** button so that **HIFI** appears beside **AUDIO OUT**.

4

Press the **EXIT/STATUS** button.

5

Press the **PLAY ▲** button to start tape playback.

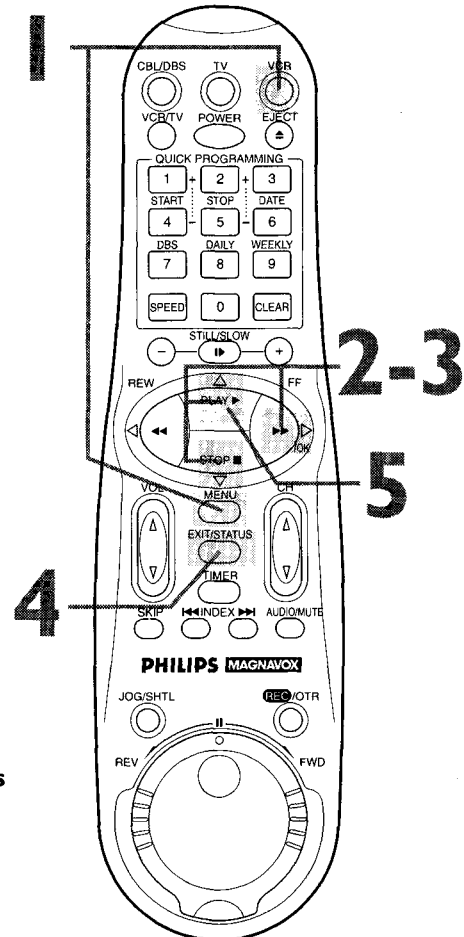

Helpful Hints

- During playback, Hi-Fi stereo may temporarily revert to normal audio when you adjust tracking. This is normal.
- If Hi-Fi stereo continually reverts to normal audio during playback, you may want to press the **FF ►/OK** button to select **MONO** at step 3.
- Only tapes recorded in Hi-Fi stereo will play in Hi-Fi stereo. Tapes recorded in normal audio will play in normal audio.
- You may also select **HIFI** or **MONO** by pressing the **VCR** button, then repeatedly pressing the **AUDIO/MUTE** button on the remote control.

Video Stabilizer 53

You can correct vertical vibration when playing back tapes recorded in SLP speed. When VIDEO STABILIZER is set to ON, vertical vibration will be corrected automatically. VIDEO STABILIZER is set to OFF when you receive the VCR.

Follow the steps below to set VIDEO STABILIZER to ON.

1 Press the **VCR** button, then press the **MENU** button.

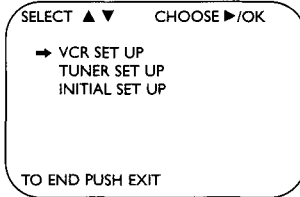

2

Press the **PLAY ▲** or **STOP ▼** button to select **VCR SET UP**, then press the **FF ►/OK** button.

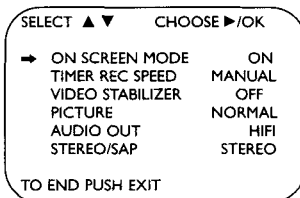

3

Press the **PLAY ▲** or **STOP ▼** button to select **VIDEO STABILIZER**, then press the **FF ►/OK** button so that **ON** appears beside **VIDEO STABILIZER**.

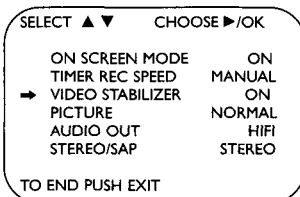

4

Press the **EXIT/STATUS** button.

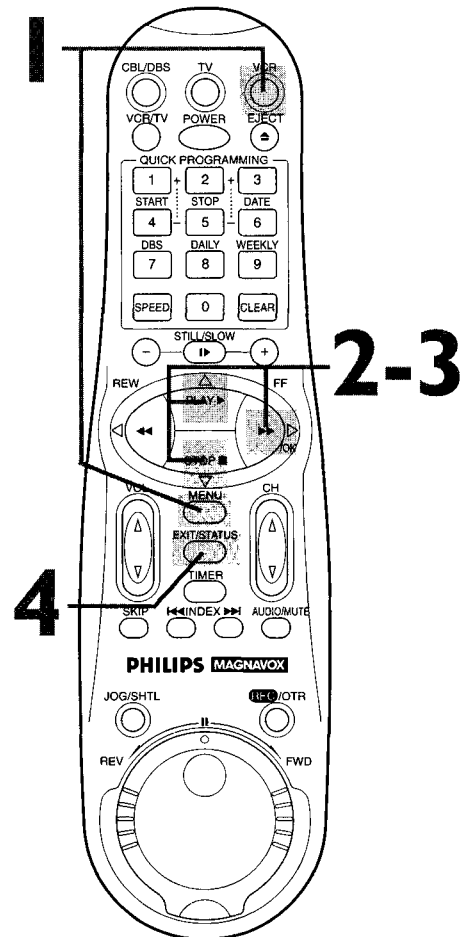

Helpful Hints

- The on-screen status display may jitter when VIDEO STABILIZER is set to ON.
- Regardless of the setting, this function has no effect on tapes recorded in SP speed, during recording, and during special effects playback.
- To set VIDEO STABILIZER to OFF, follow steps 1 - 2 above. At step 3, press the FF ►/OK button so that OFF appears beside VIDEO STABILIZER. Press the EXIT/STATUS button.

54 Incredible Picture

You can make the picture sharper or enhance a picture when playing back tapes recorded in SLP speed. PICTURE is set to NORMAL when you receive the VCR. Follow the steps below to set PICTURE to INCREDIBLE or ENHANCER.

1 Press the **VCR** button, then press the **MENU** button.

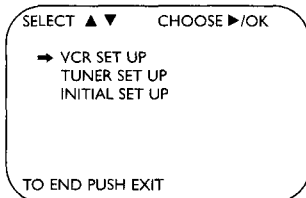

2

Press the **PLAY ▲** or **STOP ▼** button to select **VCR SET UP**, then press the **FF ►/OK** button.

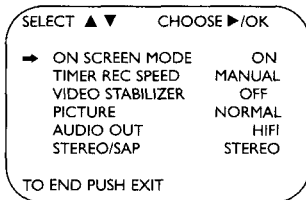

3

Press the **PLAY ▲** or **STOP ▼** button to select **PICTURE**, then press the **FF ►/OK** button repeatedly to select **ENHANCER** for an enhanced picture or **INCREDIBLE** for a sharper picture.

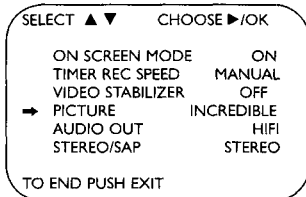

4

Press the **EXIT/STATUS** button.

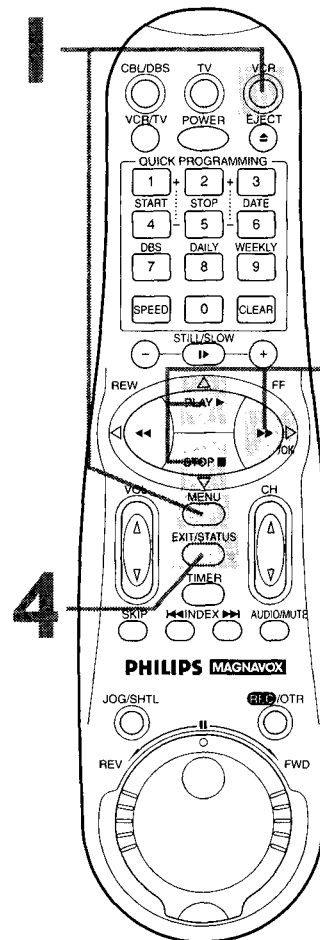

Forward and Reverse Searching

1

During tape playback, press and release the **FF ►/OK** button or the **REW(ind) ◀** button. A fast forward or reverse picture search will begin.

2

To return to playback, press the **PLAY ▲** button.

Viewing a Still Picture

1

During tape playback, press the **STILL/SLOW** button. A still picture will appear on-screen.

2

To advance the still picture frame by frame, press the **STILL/SLOW** button repeatedly.

3

To return to playback, press the **PLAY ▲** button.

Viewing a Slow Motion Picture

1

During tape playback, press and hold the **STILL/SLOW** button for three seconds. The tape will play in slow motion.

2

Press the **STILL/SLOW -/+** buttons to adjust the speed of slow motion playback. If you press and hold the **STILL/SLOW -** button during Slow Motion playback, the tape will play in reverse in slow motion.

3

To return to playback, press the **PLAY ▲** button.

Repeat Playback

1

Press and hold the **PLAY ▲** button until the **▷** light flashes on the display panel. Now, when a tape has finished playing, the VCR will rewind it and start playback again. The VCR will play the tape 50 times. The **▷** light on the display panel will flash during tape playback and while rewinding. TV programming will appear while the tape is rewinding.

Repeat Playback will be cancelled if you press the **STOP ▼**, **STILL/SLOW**, **FF ►/OK**, or **REW(ind) ◀** buttons during playback.

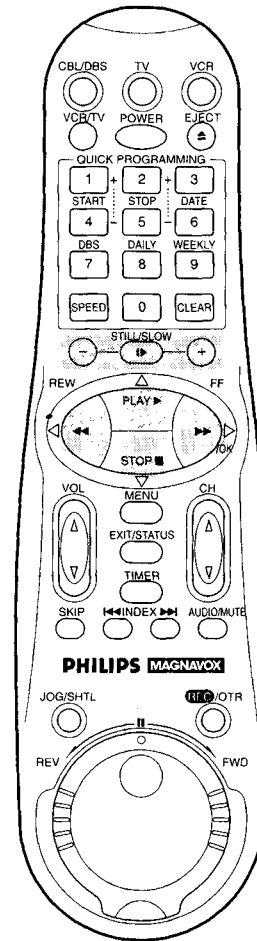

Helpful Hints

- During Search, Slow, and Still modes, there will be no sound.
- Slow and Still modes automatically switch to Stop mode after five minutes to protect the VCR and the tape from damage.
- During Forward or Reverse Searching, noise bars will appear on-screen.
- You may only view a tape in Slow Motion if the tape is recorded in SP or SLP speed.

56 Playback Options (cont'd)

Viewing Pictures in Slow to Fast Motion

1

First, press the **JOG/SHTL** (shuttle) button while in the **Play** or **Still** mode. The **JOG/SHTL** button will light.

2

Next, turn the outer ring (the **Shuttle ring**) in either direction. The farther the ring is rotated, the faster the search speed. Releasing the ring stops the picture in the **Still** mode.

3

Or, turn the inner dial (the **Jog Dial**) in either direction. The tape will move frame-by-frame at the speed with which the dial is turned.

4

Press the **PLAY** button to release the **Still** mode.

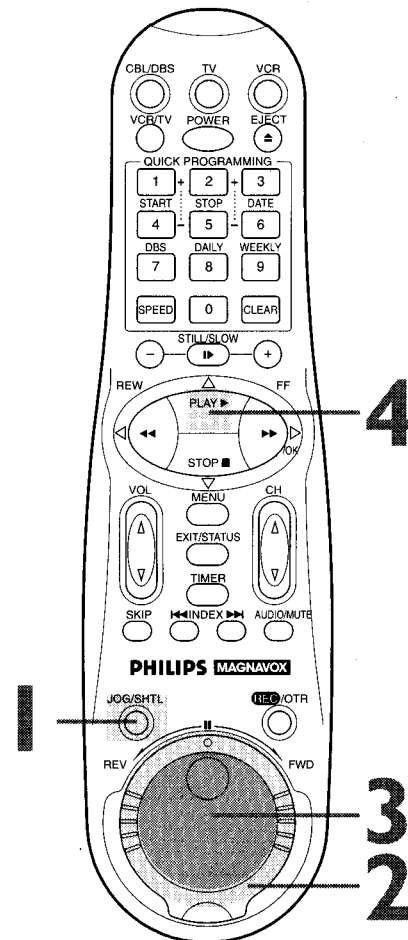

Helpful Hints

- The Jog/Shuttle Light goes off after 60 seconds if no buttons are pressed.
- You can use the Shuttle Ring on the VCR in the same manner as the Shuttle Ring on the remote control.

Automatic Operation Features 57

Automatic Playback

When you put a tape in the VCR, the power will come on automatically. If the tape's record tab is missing, playback will begin.

Automatic Rewind

When a tape is played, fast forwarded, or recorded to its end, the VCR will rewind the tape to the beginning, then stop.

Memory Rewind, Power Off

When the POWER button is pressed while the VCR is rewinding a tape, REWIND→POWER OFF will appear on-screen. When the tape has finished rewinding, the VCR will stop, then turn itself off.

Tape Eject

A tape can be ejected with the VCR power on or off (but the VCR must be plugged in).

If a timer recording is programmed, the ☺ and Cassette-Inside lights will flash on the VCR's display panel when you eject a tape with the VCR power turned off.

Counter Reset

The real-time counter will automatically be reset to 0:00:00 as you insert a cassette.

To reset the real-time counter to 0:00:00 at anytime, press the CLEAR button on the remote control.

Automatic Tracking Adjustment

The VCR continually adjusts tracking to give you the best possible picture quality. With some recordings, however, you may get a better picture by adjusting the tracking manually (see below).

Manual Tracking Adjustment

- Press the CHANNEL ▲/▼ buttons **on the VCR** to remove jitter in a still picture.
- The CHANNEL ▲/▼ buttons **on the VCR** also adjust tracking during normal tape playback.
- The VCR returns to Automatic Tracking Adjustment whenever a tape is inserted.

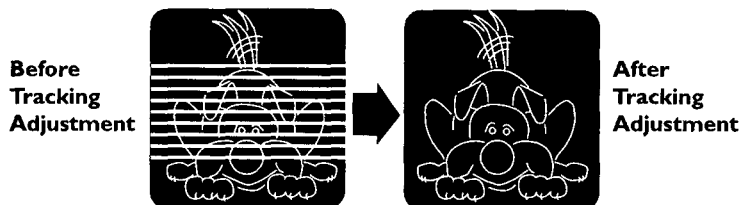

58 Glossary

AUDIO IN/OUT Jacks: jacks located on the front and back of the VCR which are used to record audio from another source (IN) or to send audio to another source (OUT).

Automatic Channel Programming: process in which the VCR scans all available channels and places the ones you receive in its memory. Then, when you press the CH(annel) ▲/▼ buttons, you only scan through channels you receive.

Bands: settings that allow you to tune channels.

- **Antenna** – VHF (very high frequency; channels 2 - 13) and UHF (ultra high frequency; channels 14 - 69).
- **Cable** – standard channels can be received without a Cable Box.

Cable Box/DBS Output Channel: one of channels 02 - 09 for the Cable Box, channel 03 - 04 for the DBS.

DBS: Direct Broadcast System.

Dubbing: copying a tape using a second VCR.

Frame: a single still picture.

HQ: high quality; a feature in the VCR circuitry which provides enhanced picture detail.

OTR: one-touch recording; programming a timed recording that starts immediately and records for 30 minutes to nine hours, whichever you specify.

Remote Control: the small electronic unit that came with your VCR; allows you to operate your VCR from a distance. The remote control may also operate some features of your TV, Cable Box, or DBS.

RF coaxial cable: the cable supplied with your VCR. Use it to connect your VCR to your TV (or Cable Box or DBS, if applicable). The supplied cable is a snap-on type. However, you may also use a screw-on type if you prefer.

Special Effects: forward and reverse searching; viewing a still picture; or viewing a slow motion picture.

Tape Speeds: how fast the tape travels during a recording or playback.

- **LP (long play)** – average tape speed (playback time for a T120 tape is approximately four hours); available for playback only. Although the VCR will play tapes recorded in LP, LP will not appear on the display panel or in the on-screen status display.
- **SLP (super long play)** – slowest tape speed (recording/playback time for a T120 tape is approximately six hours).
- **SP (standard play)** – fastest tape speed (recording/playback time for a T120 tape is approximately two hours); best picture quality.

VCR: video cassette recorder.

VIDEO IN/OUT Jacks: jacks located on the front and back of the VCR which are used to record video from another source (IN) or to send video to another source (OUT).

Specifications 59

Video Heads

Four heads with Hi-Fi stereo

Video Signal

EIA standards; NTSC color

Antenna

VHF/UHF – 75 ohm external antenna terminal

VHF Output Signal

Channel 3 or 4 (switchable)
75 ohms unbalanced

Power Requirement

120V AC; 60 Hz

Power Consumption

22W

Operating Temperature

41°F (5°C) to 104°F (40°C)

Relative Humidity

10% to 80%

Weight

6.8 lbs. (3.1 kg.)

Dimensions

15-3/4" (W) x 3-3/4" (H) x 10-7/8" (D)
(400 mm x 94 mm x 276 mm)

Tuner Broadcast Channels

VHF: 2-13

UHF: 14-69

Cable TV Channels

VHF: 2 - 13

Midband: A – I

Superband: J – W

Hyperband: A-5 – A-1

Special Channel: 5A

Ultraband: 37 – 94, 100 – 125

NOTE: Designs and specifications are subject to change without notice.

60 Helpful Hints

If you are having problems with your product, check this list of problems and possible solutions before requesting service. You may be able to solve the problem yourself.

If you need to call a customer service representative, please know the model number and serial number of your product before you call. This information is displayed on the back of the product. Also, please take a moment to identify the problem you are having, and be prepared to explain this to the representative. If you believe the representative will need to help you with operations, please stay near the product. Our representatives will be happy to assist you.

The VCR has no power.

- Make sure the power plug is completely connected to an AC (alternating current) outlet.
- Make sure the power is turned on.

A power failure occurred.

- Select a language and set up channels, if prompted to do so. *Details are on pages 13 - 14 and 21.* You may also need to reprogram your timer recordings and reset the clock if the lithium battery is not installed or is not fresh.

The VCR cannot be controlled with the remote control.

- Aim the remote control directly at the VCR's remote sensor. *Details are on pages 5 and 24.*
- Remove all obstacles between the remote control and the VCR.
- Inspect and/or replace the batteries in the remote control. *Details are on page 5.*
- Press the VCR button, then try the other buttons.

The VCR does not respond normally to the remote control. (For example, the VCR may change channels multiple times when you press the CH(annel) ▲ button once.)

- Install new batteries (preferably alkaline) in the remote control.

The VCR will not perform a timer recording.

- Make sure the recording start and stop times are set correctly. *Details are on pages 36 - 41.*
- Make sure there is a tape in the VCR.
- Make sure the tape has a record tab. *Details are on page 5.*
- Make sure the VCR power is off.
- Make sure the clock is set. *Details are on pages 15- 19.*
- The VCR may not perform or continue a timer recording if a power interruption occurs and the lithium battery is not installed or is not fresh. If timer recordings are lost, - - - should appear on the display panel. But, even if you do not see this indication and the VCR operates normally, check programmed timer recordings.
- When you turn on the VCR after a power failure, this on-screen message may appear: POWER FAILURE OCCURRED/TIMER MEMORY CLEARED (IF PROGRAMMED)/PLEASE SET PROGRAMS TO BE RECORDED/TO END PUSH EXIT. First, reset the clock. *Details are on pages 15 - 19.* Then, set up channels. *Details are on pages 13 - 14.* Finally, program the timer recordings again. *Details are on pages 36 - 41.*
- Finish programming a timer recording at least five minutes before the recording is scheduled to begin.
- If two timer recordings overlap, CLASH will appear on-screen. The earlier program has priority; the later program will not be recorded.
- If the VCR power is turned off for a timer recording and there isn't a tape in the VCR, the ☺ and Cassette-Inside lights will blink on the display panel.
- If the record tab on a tape is missing and you turn off the VCR to set a timer recording, the VCR will eject the tape. The ☺ and Cassette-Inside lights will blink on the display panel.
- Noon is 12 p.m.; midnight is 12 a.m.
- Enter the Cable Box/DBS output channel at step 3 on page 38, then select the channel to be recorded at the Cable Box/DBS. Leave the Cable Box/DBS on for the timer recording.
- If you are using the Controller, enter the Cable Box/DBS channel you want to record at step 3 on page 38. If you are not using the Controller, enter the Cable Box output channel (one of channels 02 to 09) or the DBS output channel (03 or 04) at step 3 on page 38, then select the channel to be recorded at the Cable Box/DBS. Leave the Cable Box/DBS on for the timer recording.
- If a timer recording does not occur, check the timer recordings to see if the VCR reset the timer recording for the same channel, date, and time next year. *Details are on page 41.* This may happen if a One-Touch Recording was in progress at the time of the original timer recording or if you did not turn off the VCR in time for the timer recording.

Helpful Hints (cont'd) 61

Tape can't be inserted.

- Insert the tape window side up, with the record tab facing you.
- Make sure a tape isn't already in the VCR by pressing the STOP/EJECT button on the VCR or the EJECT button on the remote control.
- Gently push the center of the tape as you put it in the VCR. Never force a tape into the VCR.

Tape can't be removed.

- Make sure the power plug is completely connected to an AC (alternating current) outlet.

The motor (cylinder) rotates even when the VCR is in Stop mode.

- To enable the quick play mechanism, the cylinder will rotate for about five minutes. This is normal. The quick play mechanism enables the tape mechanism to switch from Stop mode to Play mode in one second.

There is no playback picture, or the playback picture is noisy or contains streaks.

- Make sure the TV is on the same channel as the VCR's CH3/CH4 switch. *Details are on pages 6 - 9.*
- Make sure the VCR is in VCR position. *Details are on pages 22 and 25.*
- Make sure channel 3 or 4 is properly adjusted at the TV.
- Adjust the tracking. *Details are on page 57.*

The Number buttons won't work for channels above 69; channels above 13 cannot be received.

- Select CABLE at the TUNER SET UP menu, then let the VCR set up the channels. *Details are on pages 13 - 14.*

A TV program cannot be recorded.

- Check the connections between the VCR, TV, antenna/cable, and Cable Box/DBS (if applicable). *Details are on pages 6 - 9.*
- Make sure channels are set up correctly. *Details are on pages 13 - 14.*
- Make sure the tape has a record tab. *Details are on page 5.*

TV programs cannot be watched normally.

- Put the VCR in TV position. *Details are on pages 22 and 25.*
- Check the connections between the VCR, TV, antenna/cable, and Cable Box/DBS (if applicable). *Details are on pages 6 - 9.*

Line Input mode is selected.

- If you accidentally enter Line Input mode (L-I or L-F will appear on the display panel), use the CH(annel) ▲/▼ buttons or the Number buttons to select another channel.

Multi-Channel Television Sound System

- You can only receive and record in stereo or second audio programs that are broadcast in stereo or second audio. You can only play in stereo or second audio tapes that were recorded in stereo or second audio. *Details are on pages 50 - 52.*
- If you select second audio when second audio is not available, the VCR will record normal audio.
- When you program your VCR to record in stereo, broadcasts are recorded in Hi-Fi stereo.
- You will only get stereo sound if you use audio cables to connect the AUDIO OUT Jacks on the VCR to the AUDIO IN Jacks on your TV. The TV must be in Line Input mode. See your TV owner's manual for details.
- When you connect the AUDIO OUT Jacks on your VCR to the AUDIO IN Jacks on your TV, the stereo light on the TV might not glow. This is normal. If the VCR indicates you are receiving a stereo broadcast, you are. (STEREO will appear in the status display.)

The VCR ejects the tape when the REC(ord)/OTR button is pressed or when the VCR power is turned off to set a timer recording.

- Make sure the tape has a record tab. *Details are on page 5.*

62 Limited Warranty

VIDEO CASSETTE RECORDER

90 Days Free Labor/One Year Parts Exchange. This product must be carried in for repair.

WHO IS COVERED?

You must have proof of purchase to receive warranty service. A sales receipt or other document showing that you purchased the product is considered proof of purchase.

WHAT IS COVERED?

Warranty coverage begins the day you buy your product. For 90 days thereafter, all parts will be repaired or replaced, and labor is free. From 90 days to one year from the day of purchase, all parts will be repaired or replaced, but you pay for all labor charges. After one year from the day of purchase, you pay for the replacement or repair of all parts, and for all labor charges.

All parts, including repaired and replaced parts, are covered only for the original warranty period. When the warranty on the product expires, the warranty on all replaced and repaired parts also expires.

WHAT IS EXCLUDED?

Your warranty does not cover:

- labor charges for installation or setup of the product, adjustment of customer controls on the product, and installation or repair of antenna systems outside of the product.
- product repair and/or part replacement because of misuse, accident, unauthorized repair or other cause not within the control of Philips Consumer Electronics Company.
- reception problems caused by signal conditions or cable or antenna systems outside the unit.
- a product that requires modification or adaptation to enable it to operate in any country other than the country for which it was designed, manufactured, approved and/or authorized, or repair of products damaged by these modifications.
- incidental or consequential damages resulting from the product. (Some states do not allow the exclusion of incidental or consequential damages, so the above exclusion may not apply to you. This includes, but is not limited to, prerecorded material, whether copyrighted or not copyrighted.)
- damage caused by the use of non-VHS tapes or tapes that have not been tested and labelled for use in two, four, six, and eight hour VHS recorders.
- a product that is used for commercial or institutional purposes (including but not limited to rental purposes).

WHERE IS SERVICE AVAILABLE?

Warranty service is available in all countries where the product is officially distributed by Philips Consumer Electronics Company. In countries where Philips Consumer Electronics Company does not distribute the product, the local Philips service organization will attempt to provide service (although there

may be a delay if the appropriate spare parts and technical manual(s) are not readily available).

MAKE SURE YOU KEEP..

Please keep your sales receipt or other document showing proof of purchase. Attach it to this owner's manual and keep both nearby. Also keep the original box and packing material in case you need to return your product.

BEFORE REQUESTING SERVICE...

Please check your owner's manual before requesting service. Adjustments of the controls discussed there may save you a service call.

TO GET WARRANTY SERVICE IN U.S.A., PUERTO RICO OR U.S. VIRGIN ISLANDS...

Take the product to a Philips factory service center (see enclosed list) or authorized service center for repair. When the product has been repaired, you must pick up the unit at the center. Centers may keep defective parts.

(In U.S.A., Puerto Rico and U.S. Virgin Islands, all implied warranties, including implied warranties of merchantability and fitness for a particular purpose, are limited in duration to the duration of this express warranty. Because some states do not allow limitations on how long an implied warranty may last, this limitation may not apply to you.)

TO GET WARRANTY SERVICE IN CANADA...

Please contact Philips at:

1-800-661-6162 (French Speaking)

1-800-363-7278 (English Speaking)

(In Canada, this warranty is given in lieu of all other warranties. No other warranties are expressed or implied, including any implied warranties of merchantability or fitness for a particular purpose. Philips is not liable under any circumstances for any direct, indirect, special, incidental, or consequential damages, howsoever incurred, even if notified of the possibility of such damages.)

REMEMBER...

Please record below the model and serial numbers found on the product. Also, please fill out and mail your warranty registration card promptly. It will be easier for us to notify you if necessary.

MODEL # _____

SERIAL # _____

This warranty gives you specific legal rights. You may have other rights which vary from state to state.

Index 63

ac power cord	26	glossary	58	safety precautions	3
accessories	64	helpful hints	60 - 61	second audio broadcast	50 - 51
ant(enna) in jack	6 - 9, 26	hi-fi stereo playback	52	shuttle ring	22, 25, 56
audio in/out jacks	25 - 26, 48, 51	hookups		skip button	23
audio level indicator	24	with a cable box/dbs	8 - 9	slow motion	55 - 56
audio/mute button	23, 52	with a stereo TV	51	slp	39, 58
automatic		without a cable box	6 - 7	sp	39, 58
playback	57			specifications	59
rewind	57	incredible picture	54	speed button	23, 31, 37, 39
batteries (remote)	5	index buttons	23, 49	sqpb	30
battery (lithium)	10	index search feature	49	standard play	39, 58
cable box		jog/shtl button	22, 56	start +/- buttons	39
code	29, 45	jog dial	22, 56	stereo broadcast	50 - 51
connections	8 - 9	language selection	21	still/pause button	25
controller	43 - 45	lithium battery	10	still/slow button	23, 55
jack	26	compartment	26	still/slow +/- buttons	23, 55
output channel	8 - 9, 58	limited warranty	62	still picture	55
cable/tv channels	34 - 35	line input mode	13, 24, 48	stop ▼ button	22
cassette compartment	24	line input mode light	24	stop +/- buttons	39
cassette-inside light	24	long play	39, 58	stop/eject button	25
cbl/dbs button	22	lp	39, 58	super long play	39, 58
ch3/ch4 switch	26			table of contents	4
channel				tape	
adding	14	maintenance	5	counter display	24, 27
deleting	14	memory rewind	57	duplication	48
display	24	menu button	23	eject	57
set up	13	menu/exit button	25	speed	39, 58
▲/▼ buttons	23, 25	mts broadcast	50	speed lights	24
clear button	23, 57	number buttons	23	time remaining	27
clock		on-screen status display	27	time zone selection	17
display	24	one-touch recording	32	timer	
setting	15 - 19	operation indicators	24	button	23
automatically	18 - 19	pbs channel selection		light	24, 37, 40
manually	15 - 16	automatic	19	recording	36 - 41
time zone selection	17	manual	18	checking	41
connections	6 - 9, 48, 51	picture enhancer	54	clearing	41
contents, table of	4	play button	22, 25, 30, 55	helpful hints	60 - 61
controller		playback	30	programming	38 - 41
cable box	44 - 45	options	55 - 56	reviewing	41
connection	43	pluscode programming number	36	speed setting	42
dbs	43, 46 - 47	power button	22, 25	with vcr plus+ program-	
placement	43	program review	41	ming system	36 - 37
controls		quick programming	38 - 41	tracking adjustment	57
remote	22 - 23	rear panel	26	tv	
counter reset	57	rec(ord)/otr button	22, 25, 31	button	22
daily button	37, 40	record tab	5	controls	28
date +/- buttons	40	recording		hookups	6 - 9
daylight-saving time	20	basic	31	position	22, 25
dbs		one channel/watching	33	remote control code	28
code	29, 47	another	32		
connections	8 - 9	one-touch	32	variable slow motion	56
controller	43, 46 - 47	remote control		vcr	
output channel	8 - 9, 58	buttons	22 - 23	button	22
display panel	24	sensor	24	light	24
duplication	48	using	5	position	22, 25
eject button	22	repeat playback	55	vcr plus+ channels	34 - 35
erase protection	5	rerecording	48	vcr plus+ programming system	
exit/status button	23, 27	reverse searching	55	setting up	34 - 35
fast forward searching	55	rew(ind) ◀ button	22, 55	timer recording	36 - 37
ff (fast forward) ▶/ok		rf coaxial cable	6 - 9, 58	vcr/tv button	22, 25
button	22, 55	rf out jack	6 - 9, 26	video	
frame advance	55			in/out jacks	25 - 26, 48, 51
front panel	25			stabilizer	53
				tapes	5, 39
				vol(ume) ▲/▼ buttons	23
				warranty	62
				weekly button	37, 40

SUPPLIED ACCESSORIES

Check to be sure the items on this page are packed with your VCR. These accessories are provided to help you use or set up your VCR.

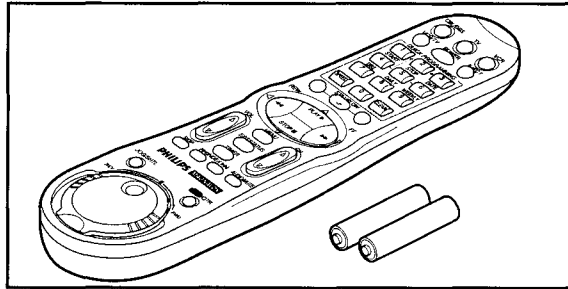

**Remote Control 4835 218 37221
Two "AA" Batteries 4835 138 17012**

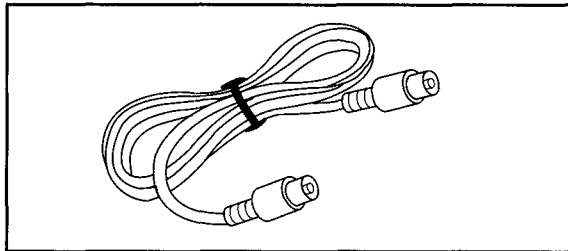

RF Coaxial Cable 4835 321 27302

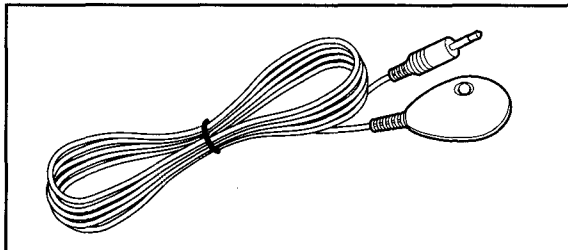

Controller 4835 321 27434

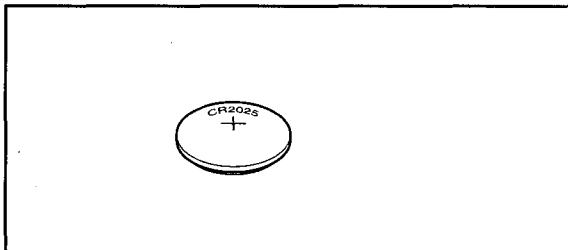

Lithium Battery (CR2025) 4835 138 17055

If any of these items are not included, or if you need to replace an item, contact Philips Service Solutions Group at the address below.

**Philips Service Solutions Group
P.O. Box 967
Greeneville, TN 37744-0967**

Or, call 1-800-851-8885.

Free Manuals Download Website

<http://myh66.com>

<http://usermanuals.us>

<http://www.somanuals.com>

<http://www.4manuals.cc>

<http://www.manual-lib.com>

<http://www.404manual.com>

<http://www.luxmanual.com>

<http://aubethermostatmanual.com>

Golf course search by state

<http://golfingnear.com>

Email search by domain

<http://emailbydomain.com>

Auto manuals search

<http://auto.somanuals.com>

TV manuals search

<http://tv.somanuals.com>