

Makita

アメリカ

Cordless Drills

10 mm (3/8'') **MODEL 6010D**

10 mm (3/8'') **MODEL 6010DW**

With Fast Charger

10 mm (3/8'') **MODEL 6010DWK**

With Fast Charger and Carrying Case

INSTRUCTION MANUAL



SPECIFICATIONS

• Model 6010D

Capacities		No load speed	Net weight	Overall length
Steel / Wood	Wood screw			
10 mm (3/8'')	4.5 mm x 20 mm (3/16'' x 3/4'')	600 R/min.	1.1 kg (2.4 lbs)	227 mm (9'')

• Battery Cartridge 7000

• Model DC7100 Fast Charger

Voltage	Input	Output	Dimensions (L x W x H)	Net weight	Charging time
7.2 V	A.C. only 50 Hz - 60 Hz	D.C. 7.2 V	145 mm x 80 mm x 61 mm (5-3/4'' x 3-1/8'' x 2-3/8'')	0.7 kg (1.5 lbs)	1 Hr.

* Manufacturer reserves the right to change specifications without notice.

* Note: Specifications may differ from country to country.

IMPORTANT SAFETY INSTRUCTIONS

(For All Tools)

WARNING: WHEN USING ELECTRIC TOOLS, BASIC SAFETY PRECAUTIONS SHOULD ALWAYS BE FOLLOWED TO REDUCE THE RISK OF FIRE, ELECTRIC SHOCK, AND PERSONAL INJURY, INCLUDING THE FOLLOWING:

READ ALL INSTRUCTIONS.

- 1. KEEP WORK AREA CLEAN.** Cluttered areas and benches invite injuries.
- 2. CONSIDER WORK AREA ENVIRONMENT.** Don't use power tools in damp or wet locations. Keep work area well lit. Don't expose power tools to rain. Don't use tool in presence of flammable liquids or gases.
- 3. KEEP CHILDREN AWAY.** All visitors should be kept away from work area. Don't let visitors contact tool or extension cord.
- 4. STORE IDLE TOOLS.** When not in use, tools should be stored in dry, and high or locked-up place — out of reach of children.
- 5. DON'T FORCE TOOL.** It will do the job better and safer at the rate for which it was intended.
- 6. USE RIGHT TOOL.** Don't force small tool or attachment to do the job of a heavy-duty tool. Don't use tool for purpose not intended.
- 7. DRESS PROPERLY.** Don't wear loose clothing or jewelry. They can be caught in moving parts. Rubber gloves and non-skid footwear are recommended when working outdoors. Wear protective hair covering to contain long hair.
- 8. USE SAFETY GLASSES.** Also use face or dust mask if cutting operation is dusty.
- 9. DON'T ABUSE CORD.** Never carry tool by cord or yank it to disconnect from receptacle. Keep cord from heat, oil, and sharp edges.
- 10. SECURE WORK.** Use clamps or a vise to hold work. It's safer than using your hand and it frees both hands to operate tool.
- 11. DON'T OVERREACH.** Keep proper footing and balance at all times.
- 12. MAINTAIN TOOLS WITH CARE.** Keep tools sharp and clean for better and safer performance. Follow instructions for lubricating and changing accessories. Inspect tool cords periodically and if damaged, have repaired by authorized service facility. Inspect extension cords periodically and replace if damaged. Keep handles dry, clean, and free from oil and grease.
- 13. DISCONNECT TOOLS.** When not in use, before servicing, and when changing accessories, such as blades, bits, cutters.

14. **REMOVE ADJUSTING KEYS AND WRENCHES.** Form habit of checking to see that keys and adjusting wrenches are removed from tool before turning it on.
15. **AVOID UNINTENTIONAL STARTING.** Don't carry plugged-in tool with finger on switch. Be sure switch is OFF when plugging in.
16. **OUTDOOR USE EXTENSION CORDS.** When tool is used outdoors, use only extension cords intended for use outdoors and so marked.
17. **STAY ALERT.** Watch what you are doing, use common sense. Don't operate tool when you are tired.
18. **CHECK DAMAGED PARTS.** Before further use of the tool, a guard or other part that is damaged should be carefully checked to determine that it will operate properly and perform its intended function. Check for alignment of moving parts, binding of moving parts, breakage of parts, mounting, and any other conditions that may affect its operation. A guard or other part that is damaged should be properly repaired or replaced by an authorized service center unless otherwise indicated elsewhere in this instruction manual. Have defective switches replaced by authorized service center. Don't use tool if switch does not turn it on and off.
19. **GUARD AGAINST ELECTRIC SHOCK.** Prevent body contact with grounded surfaces. For example; pipes, radiators, ranges, refrigerator enclosures.
20. **REPLACEMENT PARTS.** When servicing, use only identical replacement parts.

VOLTAGE WARNING: Before connecting the tool to a power source (receptacle, outlet, etc.) be sure the voltage supplied is the same as that specified on the nameplate of the tool. A power source with voltage greater than that specified for the tool can result in **SERIOUS INJURY** to the user — as well as damage to the tool. If in doubt, **DO NOT PLUG IN THE TOOL.** Using a power source with voltage less than the nameplate rating is harmful to the motor.

IMPORTANT SAFETY INSTRUCTIONS

1. **SAVE THESE INSTRUCTIONS** – This manual contains important safety and operating instructions for battery charger.
2. Before using battery charger, read all instructions and cautionary markings on (1) battery charger, (2) battery, and (3) product using battery.
3. **CAUTION** – To reduce risk of injury, charge only MAKITA Battery 7000. Other types of batteries may burst causing personal injury and damage.
4. Do not expose charger to rain or snow.
5. Use of an attachment not recommended or sold by the battery charger manufacturer may result in a risk of fire, electric shock, or injury to persons.
6. To reduce risk of damage to electric plug and cord, pull by plug rather than cord when disconnecting charger.
7. Make sure cord is located so that it will not be stepped on, tripped over, or otherwise subjected to damage or stress.
8. An extension cord should not be used unless absolutely necessary. Use of improper extension cord could result in a risk of fire and electric shock. If extension cord must be used, make sure:
 - a. That pins on plug of extension cord are the same number, size, and shape as those of plug on charger;
 - b. That extension cord is properly wired and in good electrical condition; and
 - c. That wire size is at least as large as the one specified in the table below.

TABLE 1
RECOMMENDED MINIMUM AWG SIZE FOR
EXTENSION CORDS FOR BATTERY CHARGERS

Length of Cord (Feet)	25	50	100	150
AWG Size of Cord	18	18	18	16

9. Do not operate charger with damaged cord or plug – replace them immediately.
10. Do not operate charger if it has received a sharp blow, been dropped, or otherwise damaged in any way; take it to a qualified serviceman.
11. Do not disassemble charger or battery cartridge; take it to a qualified serviceman when service or repair is required. Incorrect reassembly may result in a risk of electric shock or fire.
12. To reduce risk of electric shock, unplug charger from outlet before attempting any maintenance or cleaning. Turning off controls will not reduce this risk.

ADDITIONAL SAFETY RULES FOR CHARGER & BATTERY CARTRIDGE

1. Do not charge Battery Cartridge when temperature is BELOW 10°C (50°F) or ABOVE 40°C (104°F).
2. Do not attempt to use a step-up transformer, an engine generator or DC power receptacle.
3. Do not allow anything to cover or clog the charger vents.
4. Always cover the battery terminals with the battery cover when the battery cartridge is not used.
5. Do not short the battery cartridge:
 - (1) Do not touch the terminals with any conductive material.
 - (2) Avoid storing battery cartridge in a container with other metal objects such as nails, coins, etc.
 - (3) Do not expose battery cartridge to water or rain.
A battery short can cause a large current flow, overheating, possible burns and even a breakdown.
6. Do not store the tool and Battery Cartridge in locations where the temperature may reach or exceed 50°C (122°F).
7. Do not incinerate the Battery Cartridge even if it is severely damaged or is completely worn out. The battery cartridge can explode in a fire.

ADDITIONAL SAFETY RULES

1. Be aware that this tool is always in an operating condition, because it does not have to be plugged into an electrical outlet.
2. Always be sure you have a firm footing.
Be sure no one is below when using the tool in high locations.
3. Hold the tool firmly.
4. Keep hands away from rotating parts.
5. When drilling into walls, floors or wherever "live" electrical wires may be encountered, **DO NOT TOUCH ANY METAL PARTS OF THE TOOL!**
Hold the tool only by the insulated grasping surfaces to prevent electric shock if you drill into a "live" wire.
6. Do not leave the tool running. Operate the tool only when hand-held.
7. Do not touch the drill bit or the workpiece immediately after operation: they may be extremely hot and could burn your skin.

SAVE THESE INSTRUCTIONS.

Installing or removing battery cartridge

- Always switch off the tool before insertion or removal of the battery cartridge.
- To remove the battery cartridge, pull out the set plate on the bottom of the tool and grasp both sides of the cartridge while withdrawing it from the barrel.
- To insert the battery cartridge, align the tongue on the battery cartridge with the groove in the housing and slip it into place. Snap the set plate back into place. Be sure to close the set plate fully before using the tool.

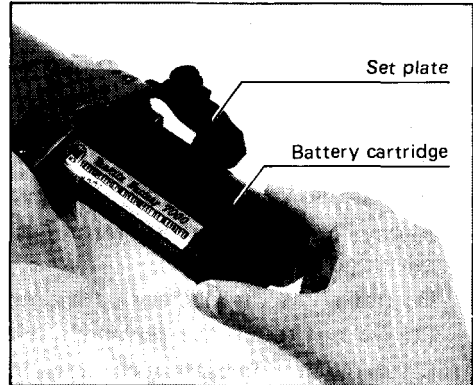

- Do not use force when inserting the battery cartridge. If the cartridge does not slide in easily, it is not being inserted correctly.

Charging

Plug the fast charger into your power source. Insert the battery cartridge so that the plus and minus terminals on the battery cartridge are on the same sides as their respective markings on the fast charger. Insert the cartridge fully into the port so that it rests on the charger port floor.

The charging light will come on and charging will begin. If the charging light does not come on, press the reset button. If the charging light goes out within 10 seconds even after pressing the reset button a couple of times, the battery cartridge is dead. (CAUTION: Wait for more than 5 seconds after the charging light goes out to press the reset button again.) Replace it with a new one. When the charging light goes out after about one hour, you may remove the fully charged battery cartridge. After charging, unplug the charger from the power source.

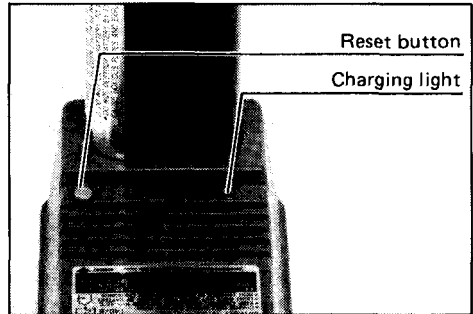

If the charging light goes out within 10 seconds even after pressing the reset button a couple of times, the battery cartridge is dead. (CAUTION: Wait for more than 5 seconds after the charging light goes out to press the reset button again.) Replace it with a new one. When the charging light goes out after about one hour, you may remove the fully charged battery cartridge. After charging, unplug the charger from the power source.

CAUTION:

- Your new battery cartridge is not charged. You will need to charge it before use.
- If you try to charge a cartridge from a just-operated tool, sometimes the charging light will not come on. If this occurs, let the cartridge cool off for a while. Then re-insert it and try to charge it once more.
- When you charge a new battery cartridge or a battery cartridge which has not been used for a long period, it may not accept a full charge. This is a normal condition and does not indicate a problem. You can recharge the battery cartridge fully after discharging it almost completely a couple of times.
- If you wish to charge two battery cartridges, allow 15 minutes between chargings on the fast charger.

Bit installation & removal

CAUTION:

Always set the Forward-Reverse switch lever to NEUTRAL when installing, removing or adjusting bits or accessories.

- **Chuck**

When installing a drill bit, notice that there are three holes in the chuck at which you must use the key for tightening. Insert the chuck key in any of the 3 holes and turn to the left (counterclockwise) to release jaws of chuck. Insert the bit and tighten with chuck key to the right. Tighten evenly at all three holes in sequence.

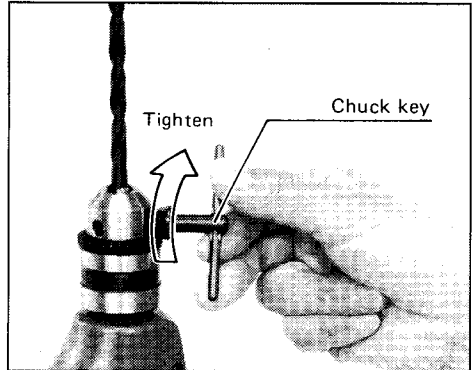

- After use, re-attach the clip-on chuck key in the hole for it on top of the tool.

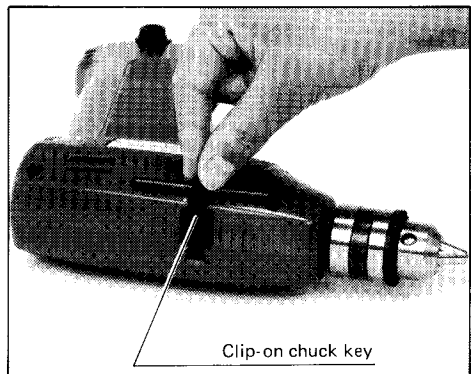

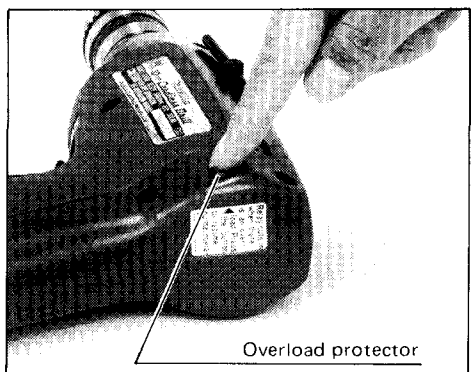

Overload protector

- The overload protector automatically cuts in to break the circuit and the button pops out, whenever heavy work is prolonged. Wait 20-30 seconds before pressing the restart button (on housing in back) to resume operation. Your finger should not be on the trigger when you press the restart button, however.



Switch action

Move the reversing switch lever to the  position for clockwise rotation or the  position for counterclockwise. To start the tool, simply pull the trigger. Release the trigger to stop. When the reversing switch lever is in the neutral position, the tool will not start even if you pull the trigger

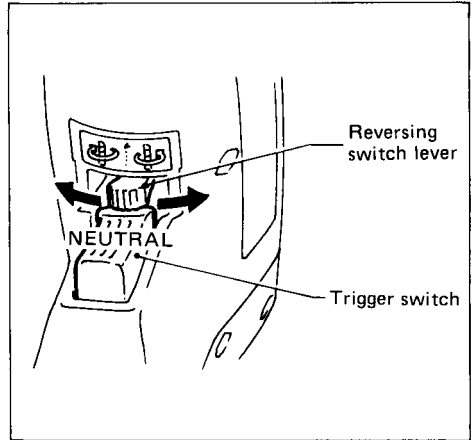

Drill

- Punch a small hole in the metal to prevent the bit from skittering when starting to drill a hole.

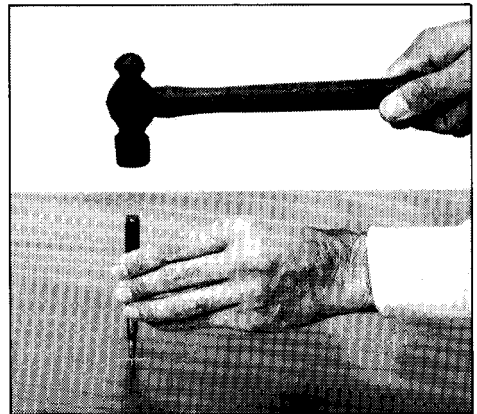

- Use machine oil on the bit to facilitate drilling.

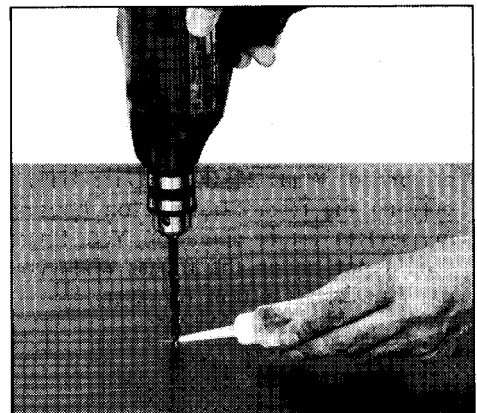

- Pressing down too hard on the tool will not speed up the drilling. In fact, this undue pressure will only serve to damage the tip of your drill bit, decrease your drilling performance and shorten the service of the tool.
- There is a tremendous force exerted on the tool/bit at the time of hole break through. Grip the drill firmly and exert care when the bit begins to break through the materials.

Screw

Match your bit to your screw.

Item	Nominal Diameter (mm)
Bit No.	Wood Screw
No. 1	2.1 – 2.7 (3/32" – 1/8")
No. 2	3.1 – 4.8 (1/8" – 3/16")

1. Phillips bits

Phillips bit No. 2 – 45 mm is standard equipped. Select your screws and nominal diameter with the chart on the right.

2. Slotted bits

Unless you use a bit that fits properly the slot on the head of the screw, the slot will be damaged and the screw will not fasten. If the bit fails to match the slot, use a grinder or some such tool to trim the bit to fit the slot.

NOTE: Rest the tool for 15 minutes when changing battery for continuous operation.

Grip

- The grip shown on the right is recommended. However, grip the tool firmly with both hands when drilling a large-diameter hole.

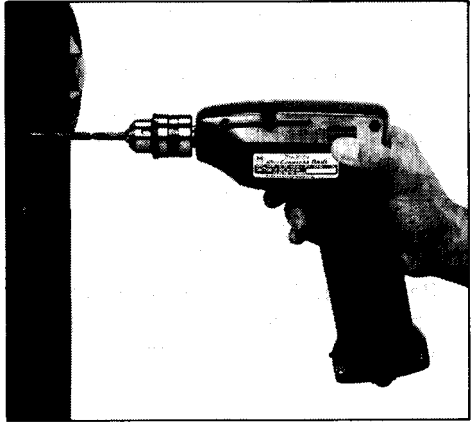

- The hole on the heel of the tool is a convenient way to carry it by a cord, hook or other means.

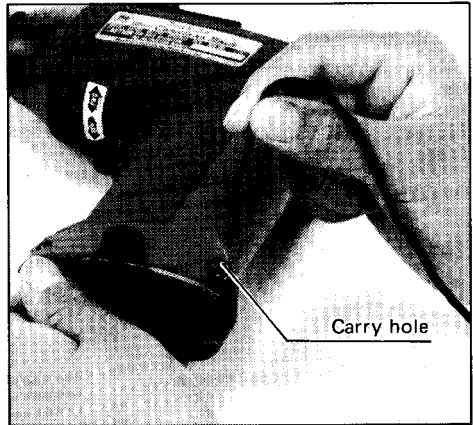



ACCESSORIES

CAUTION :

These accessories or attachments are recommended for use with your Makita tool specified in this manual. The use of any other accessories or attachments might present a risk of injury to persons. The accessories or attachments should be used only in the proper and intended manner.

• Bits

	Size	Part No.
Phillips 	#2	784214-0A
	#3	784215-0A
Slotted 	#5F	784010-0A
	#7F	784011-0A
Square drill bit 		784606-0A

• Tool holster

has some bits storage space
 Use holster to carry drill only after removing bit. Also, keep the reversing switch lever in neutral position when carrying in the holster.
 Part No. 823033-3A
 Part No. 823033-3E (Genuine leather)



• Battery holster

Holds with extra battery
 Part No. 823033-3C



• Rubber pad assembly

Part No. 123001-2



• Foam polishing pad

Part No. 743023-2



• Fast charger Model DC7100

Part No. 113086-6



• Charger 12V for car Model DC7112

Part No. 113109-0

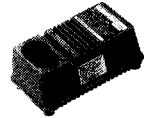

• Battery cartridge 7000

Part No. 632002-4



• Battery cover

Part No. 414938-7



• Chuck key S10

Part No. 763419-1



• Wool bonnet

Part No. 743401-6



• Plastic carrying case

Part No. 824446-4



• Keyless drill chuck

Part No. 763083-8



10 mm (3/8") CORDLESS DRILL Model 6010D

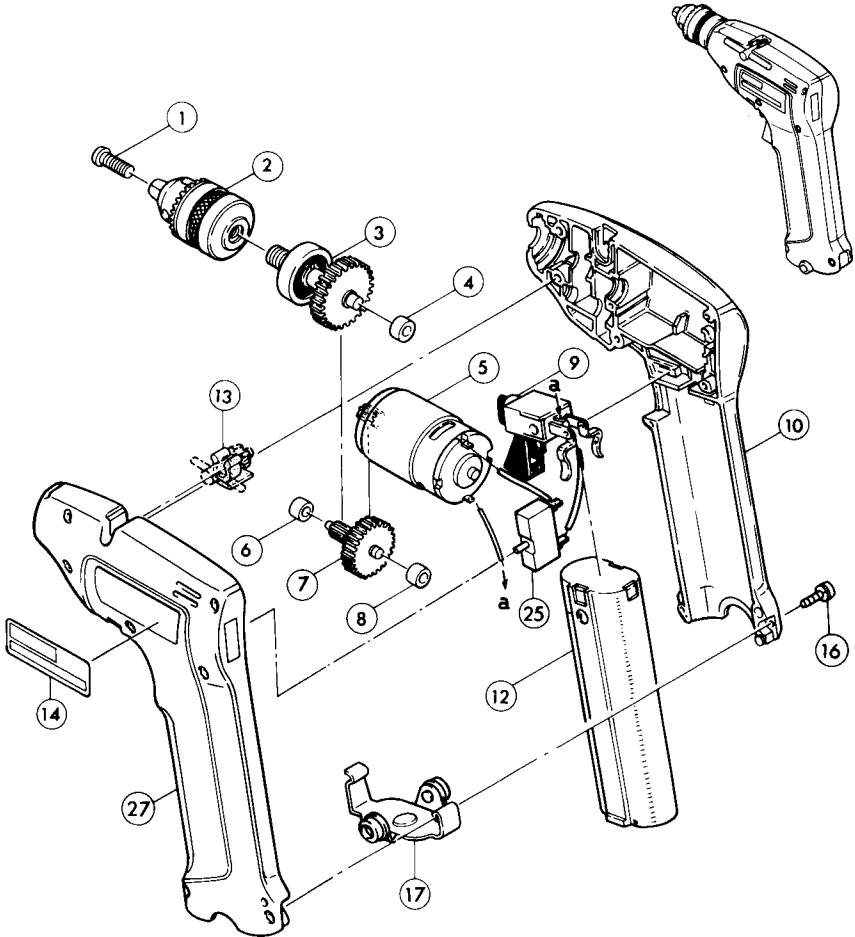

Note: The switch and other part configurations may differ from country to country.

ITEM NO.	NO. USED	DESCRIPTION	ITEM NO.	NO. USED	DESCRIPTION
<u>MACHINE</u>			<u>MACHINE</u>		
1	1	Pan Head Screw M5x18	10	1	Housing Set (With Item 27)
2	1	Drill Chuck S10	12	1	Battery 7000
3	1	Gear	13	1	Holder 6
4	1	Plane Bearing 5	14	1	Name Plate
5	1	DC Motor 7.2 V.	16	7	Pan Head Screw M4x22 (With Washer)
6	1	Plane Bearing 3	17	1	Set Plate
7	1	Gear 13-58	25	1	Over Current Relay
8	1	Plane Bearing 3	27	1	Housing Set (With Item 10)
9	1	Switch			

Note: The switch and other part specifications may differ from country to country.



Recycling the Battery

The only way to dispose of a Makita battery is to recycle it. The law prohibits any other method of disposal.

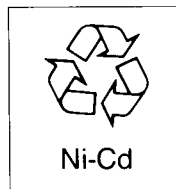

To recycle the battery:

1. Remove the battery from the tool.
2. a). Take the battery to your nearest Makita Factory Service Center
or
b). Take the battery to your nearest Makita Authorized Service Center or Distributor that has been designated as a Makita battery recycling location.

• *Call your nearest Makita Service Center or Distributor to determine the location that provides Makita battery recycling. See your local Yellow Pages under "Tools-Electric".*

MAKITA LIMITED ONE YEAR WARRANTY

Warranty Policy

Every Makita tool is thoroughly inspected and tested before leaving the factory. It is warranted to be free of defects from workmanship and materials for the period of ONE YEAR from the date of original purchase. Should any trouble develop during this one-year period, return the COMPLETE tool, freight prepaid, to one of Makita's Factory or Authorized Service Centers. If inspection shows the trouble is caused by defective workmanship or material, Makita will repair (or at our option, replace) without charge.

This Warranty does not apply where:

- repairs have been made or attempted by others;
- repairs are required because of normal wear and tear;
- The tool has been abused, misused or improperly maintained;
- alterations have been made to the tool.

IN NO EVENT SHALL MAKITA BE LIABLE FOR ANY INDIRECT, INCIDENTAL OR CONSEQUENTIAL DAMAGES FROM THE SALE OR USE OF THE PRODUCT. THIS DISCLAIMER APPLIES BOTH DURING AND AFTER THE TERM OF THIS WARRANTY.

MAKITA DISCLAIMS LIABILITY FOR ANY IMPLIED WARRANTIES, INCLUDING IMPLIED WARRANTIES OF "MERCHANTABILITY" AND "FITNESS FOR A SPECIFIC PURPOSE," AFTER THE ONE-YEAR TERM OF THIS WARRANTY.

This Warranty gives you specific legal rights, and you may also have other rights which vary from state to state. Some states do not allow the exclusion or limitation of incidental or consequential damages, so the above limitation or exclusion may not apply to you. Some states do not allow limitation on how long an implied warranty lasts, so the above limitation may not apply to you.

Makita Corporation

3-11-8, Sumiyoshi-cho,
Anjo, Aichi 446 Japan

883541G061

PRINTED IN JAPAN

1995 - 5 - N

Free Manuals Download Website

<http://myh66.com>

<http://usermanuals.us>

<http://www.somanuals.com>

<http://www.4manuals.cc>

<http://www.manual-lib.com>

<http://www.404manual.com>

<http://www.luxmanual.com>

<http://aubethermostatmanual.com>

Golf course search by state

<http://golfingnear.com>

Email search by domain

<http://emailbydomain.com>

Auto manuals search

<http://auto.somanuals.com>

TV manuals search

<http://tv.somanuals.com>