

Makita

Cordless Finishing Sander

MODEL 9035D
MODEL 9035DW
 With Fast Charger

INSTRUCTION MANUAL

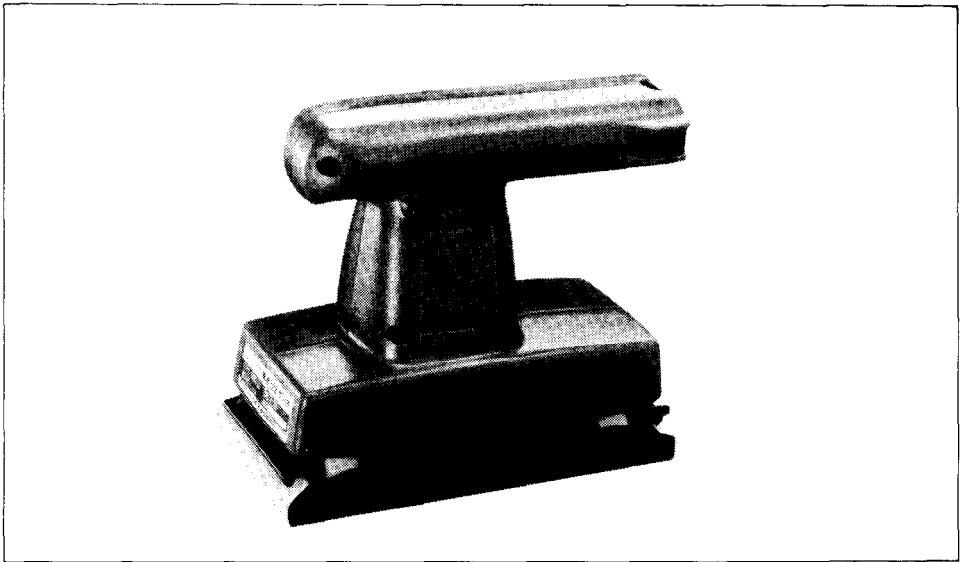

SPECIFICATIONS

• Model 9035D

Pad size	No load speed	Overall length	Net weight
93 mm x 185 mm (3-5/8" x 7-1/4")	6,000 R/min.	185 mm (7-1/4")	1.3 kg (2.9 lbs)

• Battery Cartridge 7000

• Model DC7100 Fast charger

Voltage	Charging time	Input	Output	Dimensions (L x W x H)	Net weight
7.2 V	1 Hr.	A.C. only 50 Hz 60 Hz	D.C. 7.2 V	145 mm x 80 mm x 61 mm (5-3/4" x 3-1/8" x 2-3/8")	0.7 kg (1.5 lbs)

* Manufacturer reserves the right to change specifications without notice.

* Note: Specifications may differ from country to country.

IMPORTANT SAFETY INSTRUCTIONS

(For All Tools)

WARNING: WHEN USING ELECTRIC TOOLS, BASIC SAFETY PRECAUTIONS SHOULD ALWAYS BE FOLLOWED TO REDUCE THE RISK OF FIRE, ELECTRIC SHOCK, AND PERSONAL INJURY, INCLUDING THE FOLLOWING:

READ ALL INSTRUCTIONS.

- 1. KEEP WORK AREA CLEAN.** Cluttered areas and benches invite injuries.
- 2. CONSIDER WORK AREA ENVIRONMENT.** Don't use power tools in damp or wet locations. Keep work area well lit. Don't expose power tools to rain. Don't use tool in presence of flammable liquids or gases.
- 3. KEEP CHILDREN AWAY.** All visitors should be kept away from work area. Don't let visitors contact tool or extension cord.
- 4. STORE IDLE TOOLS.** When not in use, tools should be stored in dry, and high or locked-up place — out of reach of children.
- 5. DON'T FORCE TOOL.** It will do the job better and safer at the rate for which it was intended.
- 6. USE RIGHT TOOL.** Don't force small tool or attachment to do the job of a heavy-duty tool. Don't use tool for purpose not intended.
- 7. DRESS PROPERLY.** Don't wear loose clothing or jewelry. They can be caught in moving parts. Rubber gloves and non-skid footwear are recommended when working outdoors. Wear protective hair covering to contain long hair.
- 8. USE SAFETY GLASSES.** Also use face or dust mask if cutting operation is dusty.
- 9. DON'T ABUSE CORD.** Never carry tool by cord or yank it to disconnect from receptacle. Keep cord from heat, oil, and sharp edges.
- 10. SECURE WORK.** Use clamps or a vise to hold work. It's safer than using your hand and it frees both hands to operate tool.
- 11. DON'T OVERREACH.** Keep proper footing and balance at all times.
- 12. MAINTAIN TOOLS WITH CARE.** Keep tools sharp and clean for better and safer performance. Follow instructions for lubricating and changing accessories. Inspect tool cords periodically and if damaged, have repaired by authorized service facility. Inspect extension cords periodically and replace if damaged. Keep handles dry, clean, and free from oil and grease.
- 13. DISCONNECT TOOLS.** When not in use, before servicing, and when changing accessories, such as blades, bits, cutters.

14. **REMOVE ADJUSTING KEYS AND WRENCHES.** Form habit of checking to see that keys and adjusting wrenches are removed from tool before turning it on.
15. **AVOID UNINTENTIONAL STARTING.** Don't carry plugged-in tool with finger on switch. Be sure switch is OFF when plugging in.
16. **OUTDOOR USE EXTENSION CORDS.** When tool is used outdoors, use only extension cords intended for use outdoors and so marked.
17. **STAY ALERT.** Watch what you are doing, use common sense. Don't operate tool when you are tired.
18. **CHECK DAMAGED PARTS.** Before further use of the tool, a guard or other part that is damaged should be carefully checked to determine that it will operate properly and perform its intended function. Check for alignment of moving parts, binding of moving parts, breakage of parts, mounting, and any other conditions that may affect its operation. A guard or other part that is damaged should be properly repaired or replaced by an authorized service center unless otherwise indicated elsewhere in this instruction manual. Have defective switches replaced by authorized service center. Don't use tool if switch does not turn it on and off.
19. **GUARD AGAINST ELECTRIC SHOCK.** Prevent body contact with grounded surfaces. For example; pipes, radiators, ranges, refrigerator enclosures.
20. **REPLACEMENT PARTS.** When servicing, use only identical replacement parts.

VOLTAGE WARNING: Before connecting the tool to a power source (receptacle, outlet, etc.) be sure the voltage supplied is the same as that specified on the nameplate of the tool. A power source with voltage greater than that specified for the tool can result in **SERIOUS INJURY** to the user – as well as damage to the tool. If in doubt, **DO NOT PLUG IN THE TOOL.** Using a power source with voltage less than the nameplate rating is harmful to the motor.

IMPORTANT SAFETY INSTRUCTIONS

1. **SAVE THESE INSTRUCTIONS** — This manual contains important safety and operating instructions for battery charger.
2. Before using battery charger, read all instructions and cautionary markings on (1) battery charger, (2) battery, and (3) product using battery.
3. **CAUTION** — To reduce risk of injury, charge only MAKITA Battery 7000. Other types of batteries may burst causing personal injury and damage.
4. Do not expose charger to rain or snow.
5. Use of an attachment not recommended or sold by the battery charger manufacturer may result in a risk of fire, electric shock, or injury to persons.
6. To reduce risk of damage to electric plug and cord, pull by plug rather than cord when disconnecting charger.
7. Make sure cord is located so that it will not be stepped on, tripped over, or otherwise subjected to damage or stress.
8. An extension cord should not be used unless absolutely necessary. Use of improper extension cord could result in a risk of fire and electric shock. If extension cord must be used, make sure:
 - a. That pins on plug of extension cord are the same number, size, and shape as those of plug on charger;
 - b. That extension cord is properly wired and in good electrical condition; and
 - c. That wire size is at least as large as the one specified in the table below.

TABLE 1
RECOMMENDED MINIMUM AWG SIZE FOR
EXTENSION CORDS FOR BATTERY CHARGERS

Length of Cord (Feet)	25	50	100	150
AWG Size of Cord	18	18	18	16

9. Do not operate charger with damaged cord or plug — replace them immediately.
10. Do not operate charger if it has received a sharp blow, been dropped, or otherwise damaged in any way; take it to a qualified serviceman.
11. Do not disassemble charger or battery cartridge; take it to a qualified serviceman when service or repair is required. Incorrect reassembly may result in a risk of electric shock or fire.
12. To reduce risk of electric shock, unplug charger from outlet before attempting any maintenance or cleaning. Turning off controls will not reduce this risk.

ADDITIONAL SAFETY RULES FOR CHARGER & BATTERY CARTRIDGE

1. Do not charge Battery Cartridge when temperature is BELOW 10°C (50°F) or ABOVE 40°C (104°F).
2. Do not attempt to use a step-up transformer, an engine generator or DC power receptacle.
3. Do not allow anything to cover or clog the charger vents.
4. Do not short the battery cartridge. A battery short can cause a large current flow, overheating, possible burns and even a breakdown.
5. Do not store the tool and Battery Cartridge in locations where the temperature may reach or exceed 50°C (122°F).
6. Do not incinerate the Battery Cartridge even if it is severely damaged or is completely worn out. The battery cartridge can explode in a fire.

ADDITIONAL SAFETY RULES FOR CORDLESS FINISHING SANDER

1. Be aware that this tool is always in an operating condition, because it does not have to be plugged into an electrical outlet.
2. Hold the tool firmly with both hands.
3. Do not leave the tool running. Operate the tool only when hand-held.
4. This tool has not been waterproofed, so do not use water on the working surface.

SAVE THESE INSTRUCTIONS.

Installing or removing battery cartridge

- Always switch off the tool before insertion or removal of the battery cartridge.
- To remove the battery cartridge, pull out the set plate on the tool and grasp both sides of the cartridge while withdrawing it from the barrel.
- To insert the battery cartridge, align the tongue on the battery cartridge with the groove in the housing and slip it into place. Snap the set plate back into place. Be sure to close the set plate fully before using the tool.

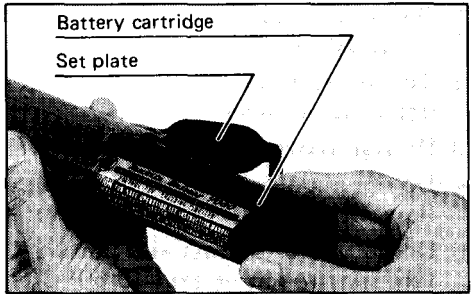

- Do not use force when inserting the battery cartridge. If the cartridge does not slide in easily, it is not being inserted correctly.

Charging

Plug the fast charger into your power source. Insert the battery cartridge so that the plus and minus terminals on the battery cartridge are on the same sides as their respective markings on the fast charger. Insert the cartridge fully into the port so that it rests on the charger port floor.

The charging light will come on and charging will begin. If the charging light does not come on, press the reset button. If the charging light goes out within 10 seconds even after pressing the reset button a couple of times, the battery cartridge is dead. (CAUTION: Wait for more than 5 seconds after the charging light goes out to press the reset button again.) Replace it with a new one. When the charging light goes out after about one hour, you may remove the fully charged battery cartridge.

After charging, unplug the charger from the power source.

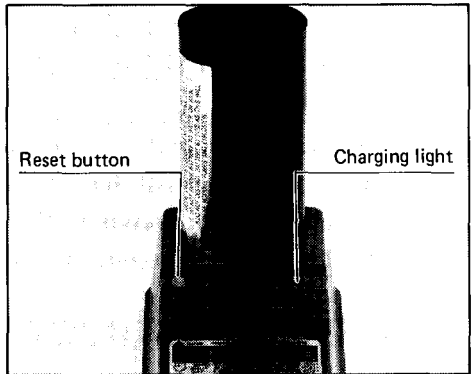

CAUTION:

- Your new battery cartridge is not charged. You will need to charge it before use.
- If you try to charge a cartridge from a just-operated tool, sometimes the charging light will not come on. If this occurs, let the cartridge cool off for a while. Then re-insert it and try to charge it once more.
- When you charge a new battery cartridge or a battery cartridge which has not been used for a long period, it may not accept a full charge. This is a normal condition and does not indicate a problem. You can recharge the battery cartridge fully after discharging it completely a couple of times.
- If you wish to charge two battery cartridges, allow 15 minutes between chargings on the fast charger.

Attaching the abrasive paper

- Pull out the clamp lever and insert the paper end. Be careful to maintain the proper paper tension. Align edges of paper with either edge of the pad. (Pre-bending the paper makes attachment easier.) Once the paper is in place, return the clamp lever to its original position. After inserting the paper, make sure the teeth of the clammer hold it securely. Otherwise the paper will be loose and subject to slippage, resulting in uneven sanding operation.

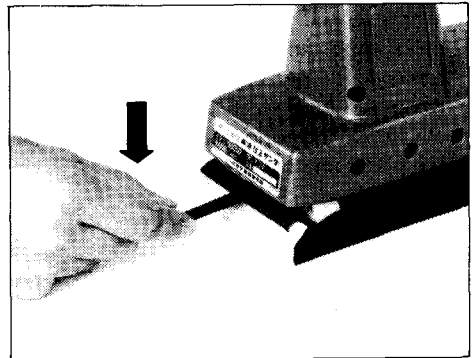
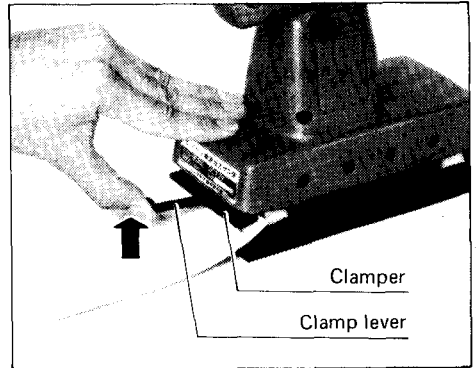

Switch action

- To start the tool, simply push the switch button. Release the switch button to stop.

CAUTION:

Before inserting the battery cartridge into the tool, be sure the switch actuates properly.

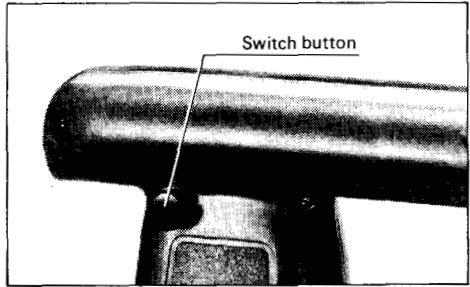

Operation

- A finishing sander is generally used to remove only a small amount of material at a time. Since the quality of the surface is more important than the amount of stock removed, do not bear down on the sander. Keep the base flush with the material at all times. Undue pressure may damage the paper and shorten tool life.



CAUTION:

Never run the tool without paper. You may seriously damage the pad.

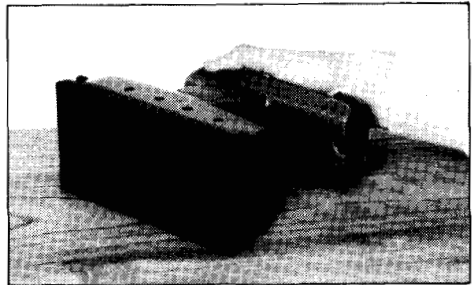

- You can put a high polish on furniture or other fine surfaces by using a cloth under the sander.

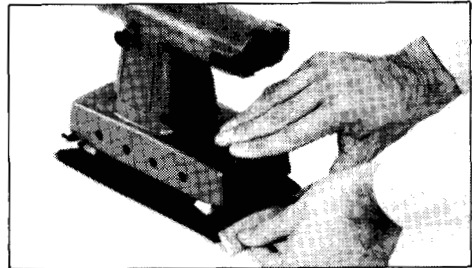

CAUTION:

If the tool is operated continuously until the battery cartridge has discharged, allow the tool to rest for 15 minutes before proceeding with a fresh battery.

MAINTENANCE

CAUTION:

Always be sure that the tool is switched off and the battery cartridge is removed before attempting to perform inspection or maintenance. To maintain product SAFETY and RELIABILITY, repairs, maintenance and adjustment should be performed by Makita Authorized or Factory Service Centers, always using Makita replacement parts.

ACCESSORIES

CAUTION:

These accessories or attachments are recommended for use with your Makita tool specified in this manual. The use of any other accessories or attachments might present a risk of injury to persons. The accessories or attachments should be used only in the proper and intended manner.

● Abrasive papers

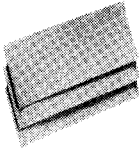

Grit	Part No.	Use	Sheets per pack
60	742506-9	Coarse	10
100	742507-7	Medium	
150	742508-5	Fine	

● Fast charger Model DC7100



● Battery cartridge 7000 Part No. 632003-2

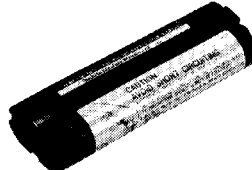

● 12 V Fast charger Model DC7012

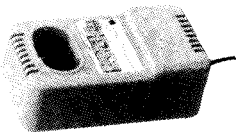

● Battery holster Part No. 823033-3C

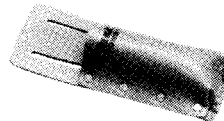

Holster holds extra battery

CORDLESS FINISHING SANDER Model 9035D

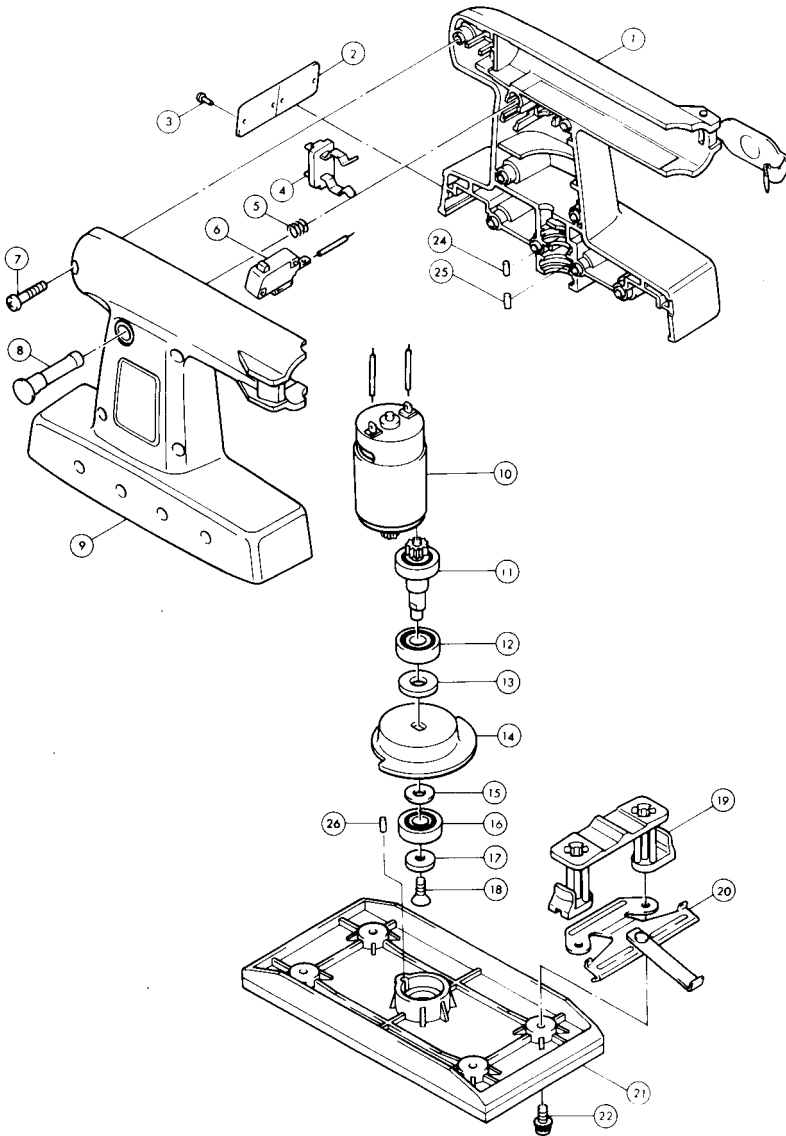

Note: The switch and other part configurations may differ from country to country.

ITEM NO.	NO. USED	DESCRIPTION	ITEM NO.	NO. USED	DESCRIPTION
<u>MACHINE</u>			<u>MACHINE</u>		
1	1	Housing Set (With Item 9)	14	1	Ballancer
2	1	Name Plate	15	1	Flat Washer 7
3	4	Rivet 0-5	16	1	Ball Bearing 627LLUX
4	1	Battery Holder	17	1	Flat Washer 5
5	1	Compression Spring 6	18	1	Countersunk Head Screw M4x10
6	1	Switch	19	2	Foot
7	8	Pan Head Screw M4x22 (With Washer)	20	2	Clamper
8	1	Push Rod	21	1	Base
9	1	Housing Set (With Item 1)	22	4	Pan Head Screw M4x12 (With Washer)
10	1	Motor	24	1	Rubber Pin 4
11	1	Spindle	25	1	Rubber Pin 4
12	1	Ball Bearing 609LLB	26	1	Rubber Pin 4
13	1	Ring 9			

Note: The switch and other part specifications may differ from country to country.

MAKITA LIMITED ONE YEAR WARRANTY

Warranty Policy

Every Makita tool is thoroughly inspected and tested before leaving the factory. It is warranted to be free of defects from workmanship and materials for the period of ONE YEAR from the date of original purchase. Should any trouble develop during this one-year period, return the COMPLETE tool, freight prepaid, to one of Makita's Factory or Authorized Service Centers. If inspection shows the trouble is caused by defective workmanship or material, Makita will repair (or at our option, replace) without charge.

This Warranty does not apply where:

- repairs have been made or attempted by others;
- repairs are required because of normal wear and tear;
- The tool has been abused, misused or improperly maintained;
- alterations have been made to the tool.

IN NO EVENT SHALL MAKITA BE LIABLE FOR ANY INDIRECT, INCIDENTAL OR CONSEQUENTIAL DAMAGES FROM THE SALE OR USE OF THE PRODUCT. THIS DISCLAIMER APPLIES BOTH DURING AND AFTER THE TERM OF THIS WARRANTY.

MAKITA DISCLAIMS LIABILITY FOR ANY IMPLIED WARRANTIES, INCLUDING IMPLIED WARRANTIES OF "MERCHANTABILITY" AND "FITNESS FOR A SPECIFIC PURPOSE," AFTER THE ONE-YEAR TERM OF THIS WARRANTY.

This Warranty gives you specific legal rights, and you may also have other rights which vary from state to state. Some states do not allow the exclusion or limitation of incidental or consequential damages, so the above limitation or exclusion may not apply to you. Some states do not allow limitation on how long an implied warranty lasts, so the above limitation may not apply to you.

Makita Corporation

3-11-8, Sumiyoshi-cho,
Anjo, Aichi 446 Japan

883551A068

PRINTED IN JAPAN

1991 — 11 — N

Free Manuals Download Website

<http://myh66.com>

<http://usermanuals.us>

<http://www.somanuals.com>

<http://www.4manuals.cc>

<http://www.manual-lib.com>

<http://www.404manual.com>

<http://www.luxmanual.com>

<http://aubethermostatmanual.com>

Golf course search by state

<http://golfingnear.com>

Email search by domain

<http://emailbydomain.com>

Auto manuals search

<http://auto.somanuals.com>

TV manuals search

<http://tv.somanuals.com>