

アメリカ

アメリカ



# Cordless Vibrating Poker

**MODEL VR250DA**  
**MODEL VR250DWA**  
 With Fast Charger

## INSTRUCTION MANUAL

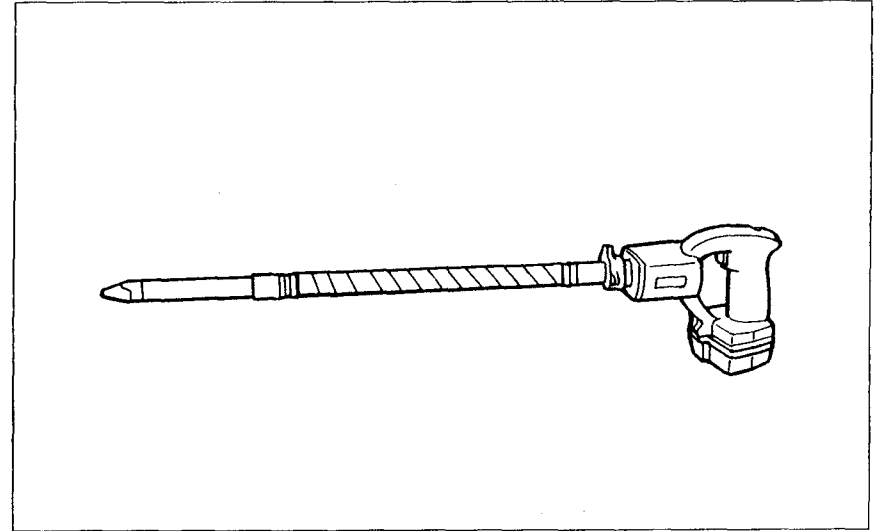

### MAKITA LIMITED ONE YEAR WARRANTY

#### Warranty Policy

Every Makita tool is thoroughly inspected and tested before leaving the factory. It is warranted to be free of defects from workmanship and materials for the period of **ONE YEAR** from the date of original purchase. Should any trouble develop during this one-year period, return the **COMPLETE** tool, freight prepaid, to one of Makita's Factory or Authorized Service Centers. If inspection shows the trouble is caused by defective workmanship or material, Makita will repair (or at our option, replace) without charge.

This Warranty does not apply where:

- repairs have been made or attempted by others;
- repairs are required because of normal wear and tear;
- The tool has been abused, misused or improperly maintained;
- alterations have been made to the tool.

**IN NO EVENT SHALL MAKITA BE LIABLE FOR ANY INDIRECT, INCIDENTAL OR CONSEQUENTIAL DAMAGES FROM THE SALE OR USE OF THE PRODUCT. THIS DISCLAIMER APPLIES BOTH DURING AND AFTER THE TERM OF THIS WARRANTY.**

**MAKITA DISCLAIMS LIABILITY FOR ANY IMPLIED WARRANTIES, INCLUDING IMPLIED WARRANTIES OF "MERCHANTABILITY" AND "FITNESS FOR A SPECIFIC PURPOSE," AFTER THE ONE-YEAR TERM OF THIS WARRANTY.**

This Warranty gives you specific legal rights, and you may also have other rights which vary from state to state. Some states do not allow the exclusion or limitation of incidental or consequential damages, so the above limitation or exclusion may not apply to you. Some states do not allow limitation on how long an implied warranty lasts, so the above limitation may not apply to you.

### SPECIFICATIONS

• Model VR250DA					
Vibrations per minute	Vibration amplitude	Vibration head (diameter x length)	Flexible shaft assembly length	Overall length	Net weight
13,000 VPM	1.1 mm (3/64")	25 mm x 221 mm (1" x 8-11/16")	800 mm (31-1/2")	1,031 mm (40-19/32")	2.3 kg (6.4 lbs)
• Battery Cartridge 1222		• Model DC1411 High Capacity Battery Charger			
Voltage		Input	Output	Charging time	
12.2 V		A.C. only 50 Hz - 60 Hz	D.C. 7.2 V - 14.4 V	1 Hr.	

• Manufacturer reserves the right to change specifications without notice.  
 • Note: Specifications may differ from country to country.  
**WARNING: For your personal safety, READ and UNDERSTAND before using.**  
**SAVE THESE INSTRUCTIONS FOR FUTURE REFERENCE.**

**Makita Corporation**  
 3-11-8, Sumiyoshi-cho,  
 Anjo, Aichi 446-8502 Japan

884119A063

PRINTED IN JAPAN  
 1998 - 7 - N

# GENERAL SAFETY RULES

(For All Battery Operated Tools)

**WARNING!** Read and understand all instructions. Failure to follow all instructions listed below, may result in electric shock, fire and/or serious personal injury.

## SAVE THESE INSTRUCTIONS

### Work Area

- **Keep your work area clean and well lit.** Cluttered benches and dark areas invite accidents.
- **Do not operate power tools in explosive atmospheres, such as in the presence of flammable liquids, gases, or dust.** Power tools create sparks which may ignite the dust or fumes.
- **Keep bystanders, children, and visitors away while operating a power tool.** Distractions can cause you to lose control.

### Electrical Safety

- **Do not abuse the cord. Never use the cord to carry the tool. Keep cord away from heat, oil, sharp edges, or moving parts. Replace damaged cords immediately.** Damaged cords may create a fire.
- **A battery operated tool with integral batteries or a separate battery pack must be recharged only with the specified charger for the battery.** A charger that may be suitable for one type of battery may create a risk of fire when used with another battery.
- **Use battery operated tool only with specifically designated battery pack.** Use of any other batteries may create a risk of fire.

### Personal Safety

- **Stay alert, watch what you are doing, and use common sense when operating a power tool. Do not use tool while tired or under the influence of drugs, alcohol, or medication.** A moment of inattention while operating power tools may result in serious personal injury.
- **Dress properly. Do not wear loose clothing or jewelry. Contain long hair. Keep your hair, clothing, and gloves away from moving parts.** Loose clothes, jewelry, or long hair can be caught in moving parts.
- **Avoid accidental starting. Be sure switch is in the locked or off position before inserting battery pack.** Carrying tools with your finger on the switch or inserting the battery pack into a tool with the switch on invites accidents.
- **Remove adjusting keys or switches before turning the tool on.** A wrench or a key that is left attached to a rotating part of the tool may result in personal injury.
- **Do not overreach. Keep proper footing and balance at all times.** Proper footing and balance enable better control of the tool in unexpected situations.

ITEM NO.	NO. USED	DESCRIPTION	ITEM NO.	NO. USED	DESCRIPTION
MACHINE			MACHINE		
1	1	Name Plate	17	1	Nut 3/8
2	7	Tapping Screw 4x18	18	1	Flexible Wire
3	1	Housing Set (With Item 27 & 28)	19	1	Flexible Hose
4	1	Switch	20	4	Tapping Screw 4x18
5	1	Switch Cover	21	1	Bearing Box
6	1	Cap	22	1	Ball Bearing 629LLB
7	1	Retaining Ring S-6	23	1	DC Motor
8	1	Ball Bearing 626	24	1	Supporter
9	1	Ball Bearing 626	25	2	Pan Head Screw M3x12
10	1	Pipe 25	26	2	Tapping Screw Blind CT 4x12
11	1	Unbalancer	27	1	Makita Label
12	1	Ball Bearing 626LLB	28	1	Housing Set (With Item 3 & 27)
13	1	Ball Bearing 626LLB	29	1	Battery Holder
14	1	Rubber Ring	30	1	High Capacity Battery 1222
15	1	Felt Ring	31	1	Cover Complete
16	1	Joint			

Note: The switch and other part specifications may differ from country to country.

- **Use safety equipment. Always wear eye protection.** Dust mask, non-skid safety shoes, hard hat, or hearing protection must be used for appropriate conditions.

#### Tool Use and Care

- **Use clamps or other practical way to secure and support the workpiece to a stable platform.** Holding the work by hand or against your body is unstable and may lead to loss of control.
- **Do not force tool. Use the correct tool for your application.** The correct tool will do the job better and safer at the rate for which it is designed.
- **Do not use tool if switch does not turn it on or off.** A tool that cannot be controlled with the switch is dangerous and must be repaired.
- **Disconnect battery pack from tool or place the switch in the locked or off position before making any adjustments, changing accessories, or storing the tool.** Such preventive safety measures reduce the risk of starting the tool accidentally.
- **Store idle tools out of reach of children and other untrained persons.** Tools are dangerous in the hands of untrained users.
- **When battery pack is not in use, keep it away from other metal objects like: paper clips, coins, keys, nails, screws, or other small metal objects that can make a connection from one terminal to another.** Shorting the battery terminals together may cause sparks, burns, or a fire.
- **Maintain tools with care. Keep cutting tools sharp and clean.** Properly maintained tools with sharp cutting edge are less likely to bind and are easier to control.
- **Check for misalignment or binding of moving parts, breakage of parts, and any other condition that may affect the tool's operation. If damaged, have the tool serviced before using.** Many accidents are caused by poorly maintained tools.
- **Use only accessories that are recommended by the manufacturer for your model.** Accessories that may be suitable for one tool may create a risk of injury when used on another tool.

#### Service

- **Tool service must be performed only by qualified repair personnel.** Service or maintenance performed by unqualified personnel may result in a risk of injury.
- **When servicing a tool, use only identical replacement parts. Follow instructions in the Maintenance section of this manual.** Use of unauthorized parts or failure to follow Maintenance Instructions may create a risk of shock of injury.

## Specific Safety Rules

1. Always keep your hands and face away from vibrating head when operating.
2. Switch off the tool immediately if you notice abnormal noise or something faulty during operation.
3. Inspect the tool carefully for breakage, cracks or deformation if you accidentally drop it or strike it against something.
4. Do not charge the battery cartridge in locations where lacquer, paint, benzene, thinner, gasoline, gas or adhesive are stored/used.
5. Do not charge on cardboard or paper, cloth or bedding, straw mats, carpeting, vinyl or the like.
6. Do not charge in a dusty place or where lint accumulates.
7. Do not allow pieces of metal, water or other foreign objects to get into the charger port where the charging terminals are located.
8. Do not carry the tool with finger on switch.
9. Do not set the tool down and switch it on. The vibrating head may whip around out of control and cause an accident.
10. Be careful not to allow water, wet concrete or the like to get into the tool. Do not let the tool fall into wet concrete.
11. Insert the vibrating head carefully between iron/steel frames or reinforcing rods not to come in contact with them.
12. Do not crush or twist the flexible hose.
13. Do not overly bend the flexible hose.
14. Use a wet cloth or the like to carefully wipe off any wet concrete left on the tool after use. Extra care should be given to thorough cleaning of the vents, switch area, cover openings, etc.

## CORDLESS VIBRATING POKER Model VR250D

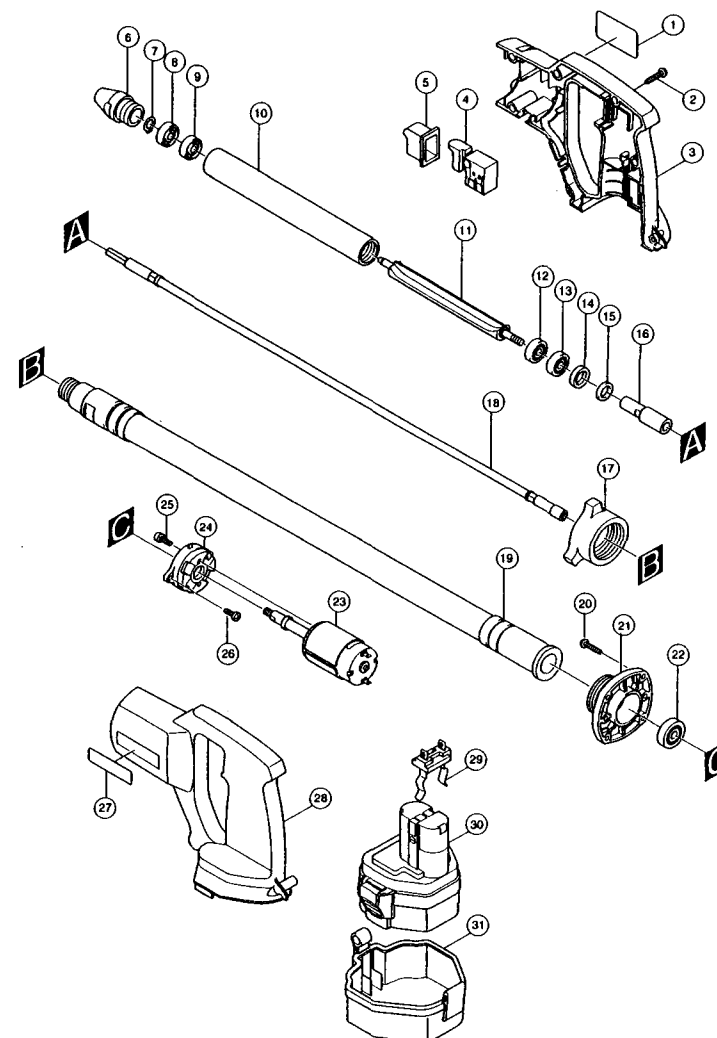

Note: The switch and other part configurations may differ from country to country.

## ACCESSORIES

### CAUTION:

These accessories or attachments are recommended for use with your Makita tool specified in this manual. The use of any other accessories or attachments might present a risk of injury to persons. The accessories or attachments should be used only in the proper and intended manner.

- **High capacity charger Model DC1411**  
Part No. 192700-7

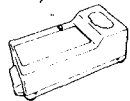

- **Battery cover**  
Part No. 414938-7



- **Battery cartridge 1222**  
Part No. 192598-2

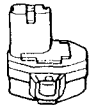







- **Plastic carrying case**  
Part No. 824486-2



## SYMBOLS

The followings show the symbols used for tool.

V	.....	volts
A	.....	amperes
Hz	.....	hertz
kg	.....	kilograms
h	.....	hours
min	.....	minutes
s	.....	seconds
	.....	alternating current
	.....	direct current
$n_0$	.....	no load speed
	.....	alternating or direct current
	.....	Class II Construction
	.....	splash-proof construction
	.....	watertight construction
.../min	.....	revolutions or reciprocation per min
	.....	number of blow

# IMPORTANT SAFETY INSTRUCTIONS FOR CHARGER & BATTERY CARTRIDGE

1. **SAVE THESE INSTRUCTIONS** — This manual contains important safety and operating instructions for battery charger.
2. Before using battery charger, read all instructions and cautionary markings on (1) battery charger, (2) battery, and (3) product using battery.
3. **CAUTION** — To reduce risk of injury, charge only MAKITA Battery Cartridge 7000, 7001, 7002, 9000, 9001, 9002, 9100, 9101, 9101A, 9102, 9102A, 9122, 1200, 1201, 1201A, 1202, 1202A, 1210, 1211, 1222 OR 1422. Other types of batteries may burst causing personal injury and damage.
4. Do not expose charger to rain or snow.
5. Use of an attachment not recommended or sold by the battery charger manufacturer may result in a risk of fire, electric shock, or injury to persons.
6. To reduce risk of damage to electric plug and cord, pull by plug rather than cord when disconnecting charger.
7. Make sure cord is located so that it will not be stepped on, tripped over, or otherwise subjected to damage or stress.
8. An extension cord should not be used unless absolutely necessary. Use of improper extension cord could result in a risk of fire and electric shock. If extension cord must be used, make sure:
  - a. That pins on plug of extension cord are the same number, size, and shape as those of plug on charger;
  - b. That extension cord is properly wired and in good electrical condition; and
  - c. That wire size is at least as large as the one specified in the table below.

**TABLE 1**  
**RECOMMENDED MINIMUM AWG SIZE FOR**  
**EXTENSION CORDS FOR BATTERY CHARGERS**

Length of Cord (Feet)	25	50	100	150
AWG Size of Cord	18	18	18	16

9. Do not operate charger with damaged cord or plug — replace them immediately.
10. Do not operate charger if it has received a sharp blow, been dropped, or otherwise damaged in any way; take it to a qualified serviceman.
11. Do not disassemble charger or battery cartridge; take it to a qualified serviceman when service or repair is required. Incorrect reassembly may result in a risk of electric shock or fire.
12. To reduce risk of electric shock, unplug charger from outlet before attempting any maintenance or cleaning. Turning off controls will not reduce this risk.

## MAINTENANCE

### CAUTION:

Always be sure that the tool is switched off and the battery cartridge is removed before attempting to perform inspection or maintenance.

## Recycling the Battery

The only way to dispose of a Makita battery is to recycle it. The law prohibits any other method of disposal.

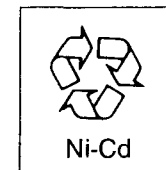

To recycle the battery:

1. Remove the battery from the tool.
2. a). Take the battery to your nearest Makita Factory Service Center or  
or  
b). Take the battery to your nearest Makita Authorized Service Center or Distributor that has been designated as a Makita battery recycling location.
  - Call your nearest Makita Service Center or Distributor to determine the location that provides Makita battery recycling. See your local Yellow Pages under "Tools-Electric".

To maintain product SAFETY and RELIABILITY, repairs, maintenance or adjustment should be performed by Makita Authorized or Factory Service Centers, always using Makita replacement parts.

### Effective leveling and removal of air bubbles

Removal of the air bubbles is complete after you have worked the tool throughout each effective range, the concrete stops shrinking, and the mortar has risen evenly to the surface, giving off a light appearance. Gently remove the operating tool not to leave holes.

#### NOTE:

- Vibrating too long in a single place causes concrete segregation.
- When the coarse aggregate segregates when placing concrete, shovel out the coarse aggregate and put it where there is plenty of mortar. Then use the tool on it. Don't leave coarse aggregate in the segregated condition.

When concreting a slope site, always pour from the bottom at the beginning. This way the weight of the freshly poured concrete and vibration will lead to effective removal of air bubbles. Conversely, if the pouring is done first from above, the mortar will separate and eventually slide to the bottom.

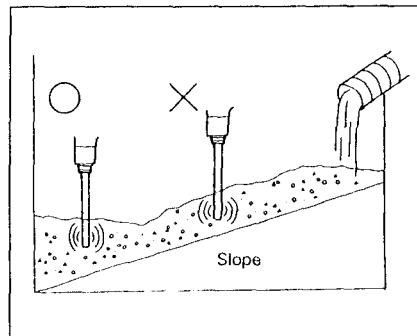

## ADDITIONAL SAFETY RULES FOR CHARGER & BATTERY CARTRIDGE

1. Do not charge Battery Cartridge when temperature is BELOW 10°C (50°F) or ABOVE 40°C (104°F).
2. Do not attempt to use a step-up transformer, an engine generator or DC power receptacle.
3. Do not allow anything to cover or clog the charger vents.
4. Always cover the battery terminals with the battery cover when the battery cartridge is not used.
5. A battery short can cause a large current flow, overheating, possible burns and even a breakdown.
  - (1) Do not touch the terminals with any conductive material.
  - (2) Avoid storing battery cartridge in a container with other metal objects such as nails, coins, etc.
  - (3) Do not expose battery cartridge to water or rain.
6. Do not store the tool and Battery Cartridge in locations where the temperature may reach or exceed 50°C (122°F).
7. Do not incinerate the Battery Cartridge even if it is severely damaged or is completely worn out. The battery cartridge can explode in a fire.

**SAVE THESE INSTRUCTIONS.**

### Installing or removing battery cartridge

- Always switch off the tool before insertion or removal of the battery cartridge.

- To remove the battery cartridge, open the cover and withdraw the battery cartridge from the tool while pressing the buttons on both sides of the cartridge.

- To insert the battery cartridge, align the tongue on the battery cartridge with the groove in the housing and slip it into place. Always insert it all the way until it locks in place with a little click. If not, it may accidentally fall out of the tool, causing injury to you or someone around you.

- Do not use force when inserting the battery cartridge. If the cartridge does not slide in easily, it is not being inserted correctly.

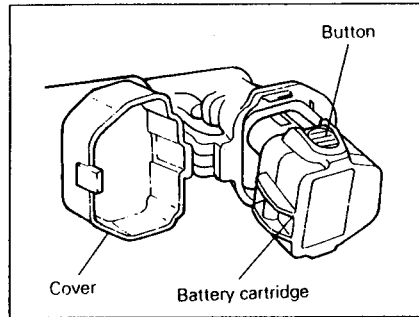

### Charging

- Your new battery cartridge is not charged. You will need to charge it before use. Use the high capacity battery charger Model DC1411 to charge the battery cartridge.

- Plug the high capacity battery charger into the proper A.C. voltage source. The charging light will flash in green color.

- Insert the battery cartridge so that the plus and minus terminals on the battery cartridge are on the same sides as their respective markings on the high capacity battery charger. Insert the cartridge fully into the port so that it rests on the charger port floor.

- When the battery cartridge is inserted, the charging light color will change from green to red and charging will begin. The charging light will remain lit steadily during charging.

- When charging is completed, the charging light color will change from red to green. The charging time is approximately one hour.

- After charging, unplug the charger from the power source.

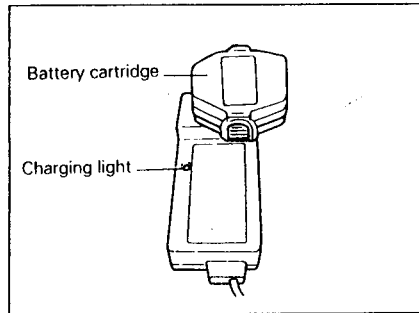

### CAUTION:

- The high capacity battery charger Model DC1411 is for charging Makita battery cartridge. Never use it for other purposes or for other manufacturer's batteries.

- When you charge a new battery cartridge or a battery cartridge which has not been used for a long period of time, it may not accept a full charge. This is a normal condition and does not indicate a problem. You can recharge the battery cartridge fully after discharging it completely and recharging a couple of times.

- If you charge a battery cartridge from a just-operated tool or a battery cartridge which has been left in a location exposed to direct sunlight or heat for a long time, the charging light may flash in red color. If this occurs, wait for a while. Charging will begin after the battery cartridge cools. The battery cartridge will cool faster if you remove the battery cartridge from the high capacity battery charger.

- If the charging light flashes alternately in green and red color a problem exists and charging is not possible. The terminals on the charger or battery cartridge are clogged with dust or the battery cartridge is worn out or damaged.

- If you wish to charge two battery cartridge, allow 15 minutes between charging on the high capacity battery charger.

### OPERATION

#### Switch action

#### CAUTION:

Before inserting the battery cartridge into the tool, always check to see that the switch trigger actuates properly and returns to the "OFF" position when released.

To start the tool, simply pull the trigger. Release the trigger to stop.

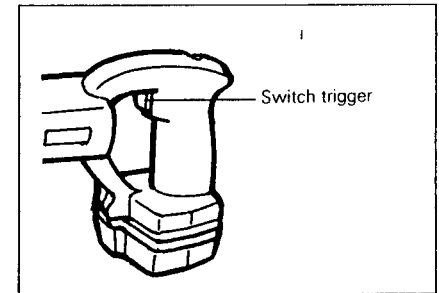

#### Operation

Hold the tool straight when inserting /operating. Use the tool within the effective vibrations range at equidistant intervals. The effective air bubble removal range is about ten times the diameter of the vibrating head, or around 250 mm (9-27/32") with Model VR250DA / VR250DWAE.

Do not use this tool to move concrete within a form. The mortar will just move away and the coarse aggregate will remain, causing segregation.

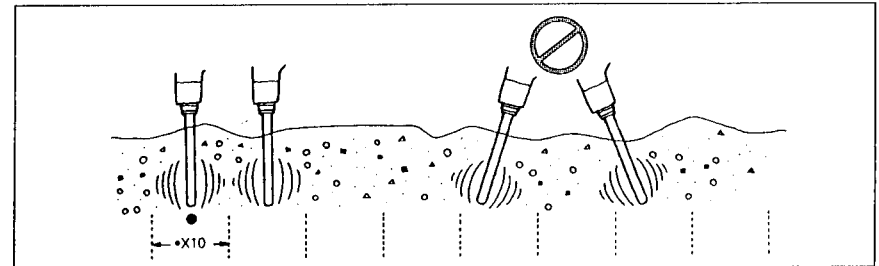



## Free Manuals Download Website

<http://myh66.com>

<http://usermanuals.us>

<http://www.somanuals.com>

<http://www.4manuals.cc>

<http://www.manual-lib.com>

<http://www.404manual.com>

<http://www.luxmanual.com>

<http://aubethermostatmanual.com>

Golf course search by state

<http://golfingnear.com>

Email search by domain

<http://emailbydomain.com>

Auto manuals search

<http://auto.somanuals.com>

TV manuals search

<http://tv.somanuals.com>