

Makita

アメリカ

Rotary Hammer

25 mm (1") MODEL HR2511
Variable Speed

INSTRUCTION MANUAL

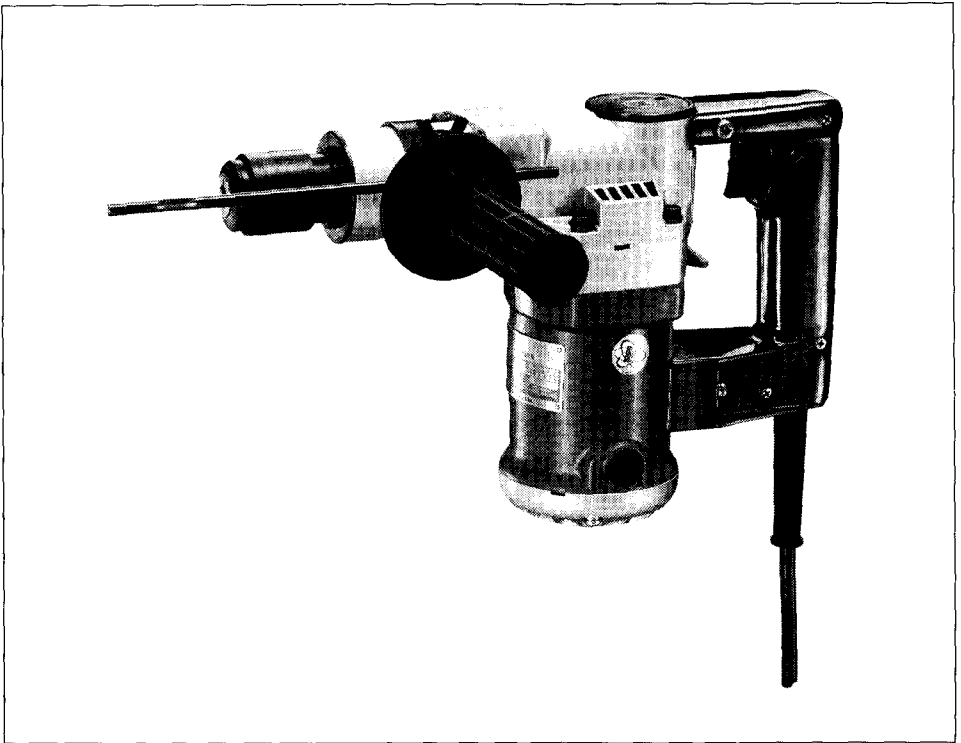

SPECIFICATIONS

Capacities			No load speed (RPM)	Blows per min.	Overall length	Net weight
Wood	Steel	Concrete				
30 mm (1-3/16")	13 mm (1/2")	25 mm (1")	0 - 800	0 - 3,000	335 mm (13-3/16")	4.2 kg (9.2 lbs)

- * Manufacturer reserves the right to change specifications without notice.
- * Note: Specifications may differ from country to country.

IMPORTANT SAFETY INSTRUCTIONS

(For All Tools)

WARNING: WHEN USING ELECTRIC TOOLS, BASIC SAFETY PRECAUTIONS SHOULD ALWAYS BE FOLLOWED TO REDUCE THE RISK OF FIRE, ELECTRIC SHOCK, AND PERSONAL INJURY, INCLUDING THE FOLLOWING:

READ ALL INSTRUCTIONS.

- 1. KEEP WORK AREA CLEAN.** Cluttered areas and benches invite injuries.
- 2. CONSIDER WORK AREA ENVIRONMENT.** Don't use power tools in damp or wet locations. Keep work area well lit. Don't expose power tools to rain. Don't use tool in presence of flammable liquids or gases.
- 3. KEEP CHILDREN AWAY.** All visitors should be kept away from work area. Don't let visitors contact tool or extension cord.
- 4. STORE IDLE TOOLS.** When not in use, tools should be stored in dry, and high or locked-up place – out of reach of children.
- 5. DON'T FORCE TOOL.** It will do the job better and safer at the rate for which it was intended.
- 6. USE RIGHT TOOL.** Don't force small tool or attachment to do the job of a heavy-duty tool. Don't use tool for purpose not intended; for example, don't use circular saw for cutting tree limbs or logs.
- 7. DRESS PROPERLY.** Don't wear loose clothing or jewelry. They can be caught in moving parts. Rubber gloves and non-skid footwear are recommended when working outdoors. Wear protective hair covering to contain long hair.
- 8. USE SAFETY GLASSES.** Also use face or dust mask if cutting operation is dusty.
- 9. DON'T ABUSE CORD.** Never carry tool by cord or yank it to disconnect from receptacle. Keep cord from heat, oil, and sharp edges.
- 10. SECURE WORK.** Use clamps or a vise to hold work. It's safer than using your hand and it frees both hands to operate tool.
- 11. DON'T OVERREACH.** Keep proper footing and balance at all times.
- 12. MAINTAIN TOOLS WITH CARE.** Keep tools sharp and clean for better and safer performance. Follow instructions for lubricating and changing accessories. Inspect tool cords periodically and if damaged, have repaired by authorized service facility. Inspect extension cords periodically and replace if damaged. Keep handles dry, clean, and free from oil and grease.
- 13. DISCONNECT TOOLS.** When not in use, before servicing, and when changing accessories, such as blades, bits, cutters.

- 14. **REMOVE ADJUSTING KEYS AND WRENCHES.** Form habit of checking to see that keys and adjusting wrenches are removed from tool before turning it on.
- 15. **AVOID UNINTENTIONAL STARTING.** Don't carry tool with finger on switch. Be sure switch is OFF when plugging in.
- 16. **EXTENSION CORDS.** Make sure your extension cord is in good condition. When using an extension cord, be sure to use one heavy enough to carry the current your product will draw. An undersized cord will cause a drop in line voltage resulting in loss of power and overheating. Table 1 shows the correct size to use depending on cord length and nameplate ampere rating. If in doubt, use the next heavier gage. The smaller the gage number, the heavier the cord.

TABLE 1 MINIMUM GAGE FOR CORD SETS

		Total Length of Cord in Feet			
		0 – 25	26 – 50	51 – 100	101 – 150
Ampere Rating More Than	Not More Than	A W G			
0	– 6	18	16	16	14
6	– 10	18	16	14	12
10	– 12	16	16	14	12
12	– 16	14	12	Not Recommended	

- 17. **OUTDOOR USE EXTENSION CORDS.** When tool is used outdoors, use only extension cords intended for use outdoors and so marked.
- 18. **STAY ALERT.** Watch what you are doing, use common sense. Don't operate tool when you are tired.
- 19. **CHECK DAMAGED PARTS.** Before further use of the tool, a guard or other part that is damaged should be carefully checked to determine that it will operate properly and perform its intended function. Check for alignment of moving parts, binding of moving parts, breakage of parts, mounting, and any other conditions that may affect its operation. A guard or other part that is damaged should be properly repaired or replaced by an authorized service center unless otherwise indicated elsewhere in this instruction manual. Have defective switches replaced by authorized service center. Don't use tool if switch does not turn it on and off.
- 20. **GUARD AGAINST ELECTRIC SHOCK.** Prevent body contact with grounded surfaces. For example; pipes, radiators, ranges, refrigerator enclosures.
- 21. **PROPER GROUNDING.** This tool should be grounded while in use to protect the operator from electric shock.
- 22. **EXTENSION CORDS:** Use only three-wire extension cords which have three-prong grounding-type plugs and three-pole receptacles which accept the tool's plug. Replace or repair damaged or worn cord immediately.
- 23. **REPLACEMENT PARTS.** When servicing, use only identical replacement parts.

VOLTAGE WARNING: Before connecting the tool to a power source (receptacle, outlet, etc.) be sure the voltage supplied is the same as that specified on the nameplate of the tool. A power source with voltage greater than that specified for the tool can result in **SERIOUS INJURY** to the user — as well as damage to the tool. If in doubt, **DO NOT PLUG IN THE TOOL**. Using a power source with voltage less than the nameplate rating is harmful to the motor.

For all grounded tools with American type plug.

GROUNDING INSTRUCTIONS: This tool should be grounded while in use to protect the operator from electric shock. The tool is equipped with a three-conductor cord and three-prong grounding-type plug to fit the proper grounding-type receptacle. The green (or green and yellow) conductor in the cord is the grounding wire. Never connect the green (or green and yellow) wire to a live terminal. Your unit is for use on 115 volts and has a plug that looks like Fig. "A".

An adapter Fig. "B" and "C" is available for connecting Fig. "A" type plugs to two-prong receptacles. The green-colored rigid ear, lug, etc., extending from the adapter must be connected to a permanent ground, such as a properly grounded outlet box.

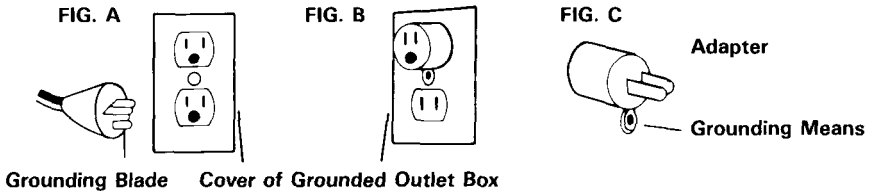

ADDITIONAL SAFETY RULES

1. Wear a hard hat (safety helmet), safety glasses and/or face shield. It is also highly recommended that you wear a dust mask, ear protectors and thickly padded gloves.
2. Be sure the bit is secured in place before operation.
3. Under normal operation, the tool is designed to produce vibration. The screws can come loose easily, causing a breakdown or accident. Check tightness of screws carefully before operation.
4. In cold weather or when the tool has not been used for a long time, let the tool warm up for several minutes by operating it under no load. This will loosen up the lubrication. Without proper warm-up, hammering operation is difficult.
5. Always be sure you have a firm footing.
Be sure no one is below when using the tool in high locations.
6. Hold the tool firmly with both hands.
7. Keep hands away from moving parts.
8. Do not leave the tool running. Operate the tool only when hand-held.
9. Do not point the tool at any one in the area when operating. The bit could fly out and injure someone seriously.
10. When drilling or chipping into walls, floors or wherever "live" electrical wires may be encountered, **DO NOT TOUCH ANY METAL PARTS OF THE TOOL!** Hold the tool by the insulated grasping surfaces to prevent electric shock if you drill or chip into a "live" wire.
11. Do not touch the bit or parts close to the bit immediately after operation; they may be extremely hot and could burn your skin.

SAVE THESE INSTRUCTIONS.

Bit grease

Coat the bit shank head beforehand with a small amount (about 0.5–1 g; 0.02–0.04 oz.) of bit grease. This chuck lubrication assures smooth action and longer service life.

Installing or removing drill bit

CAUTION:

Always be sure that the tool is switched off and unplugged before installing or removing the bit.

To install the bit, press the change ring in the direction of the arrow, align the key groove on the bit shank with the red dot and insert the bit. Now release the change ring. If the change ring does not return to its original position easily, turn the bit slightly in either direction.

To remove the bit, press the change ring in the direction of the arrow and the bit will slip out.

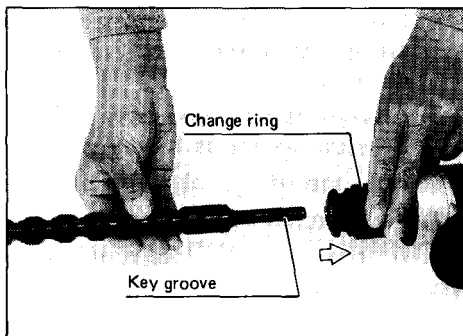

Adjusting depth of drilling

Loosen the wing bolt and adjust the depth gauge to the desired depth. After adjusting, tighten the wing bolt.

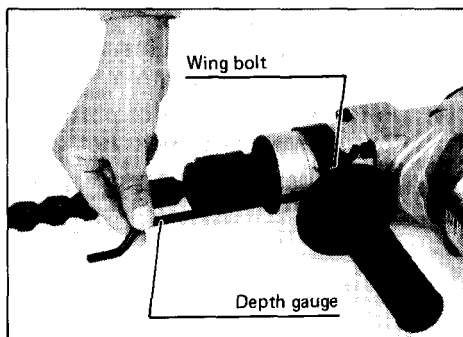

Side grip (auxiliary handle)

The side grip swings around to either side, allowing easy handling of the tool in any position. Loosen the side grip by turning it counterclockwise, swing it to the desired position and then tighten it by turning clockwise.

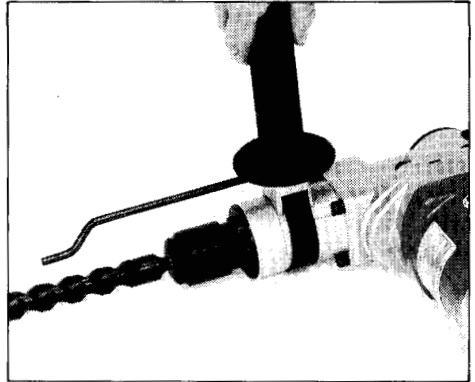

Selecting action mode

Rotation with hammering:

For drilling in concrete, granite, tile, etc., rotate the change lever to the  position.

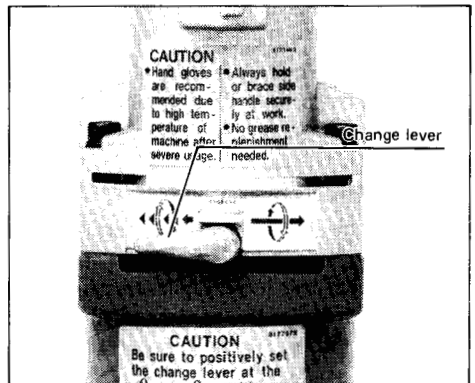

Rotation only:

For drilling in wood or metal, rotate the change lever to the  position.



CAUTION:

To avoid rapid wear on the mode change mechanism, be sure that the change lever is always positively located in one of the two action mode positions.

Switch action

Too speed is increased by increasing pressure on the trigger. To start the tool, simply pull the trigger. Release the trigger to stop. A speed control screw is provided so that maximum tool speed can be limited (variable). Turn the speed control screw clockwise for higher speed, and counterclockwise for lower speed.

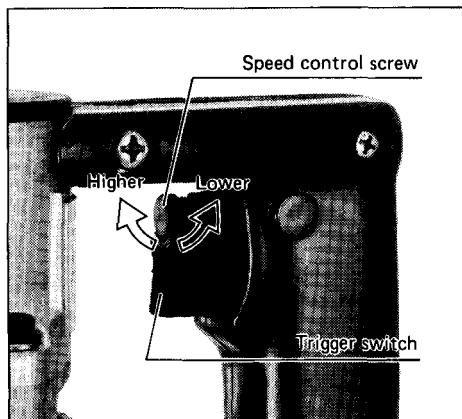

CAUTION:

- Before plugging in the tool, always check to see that the trigger switch actuates properly and returns to the "OFF" position when released.
- Do not tape, tie or otherwise secure the trigger in the "ON" position.

Hammer drilling operation

Position the bit at the location for the hole, then pull the trigger.

Do not force the tool. Light pressure gives best results. Keep the tool in position and prevent it from slipping away from the hole.

Do not apply more pressure when the hole becomes clogged with chips or particles. Instead, run the tool at an idle, then remove from the hole. By repeating this several times, the hole will be cleaned out.

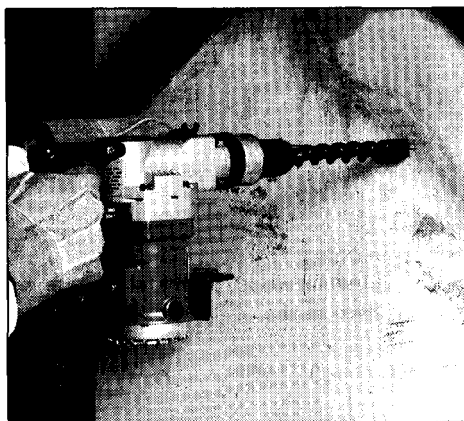

Driving in anchor manually

The drill bit has a red marking at a point corresponding to the anchor length. So drill to that depth.

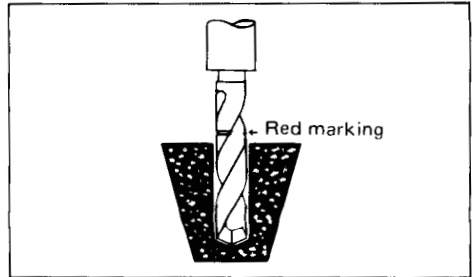

Use the blow-out bulb to clean out the hole.

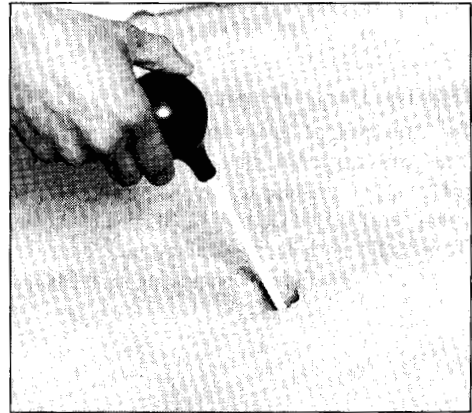

Put a plug on the anchor and hammer it into the concrete.

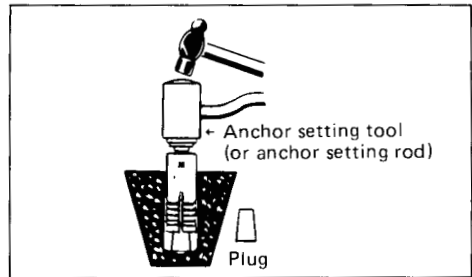

Screw in a bolt to fasten equipment.

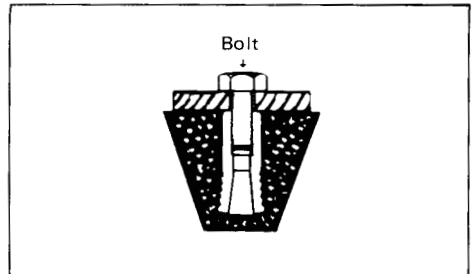

Dust collector

Use the dust collector for safe, sanitary overhead operations. Install the bit, then attach the dust collector on the end by turning and applying pressure. Then secure it by turning the metal retainer clockwise.

CAUTION:

Empty the dust collector of its contents after drilling every 2 or 3 holes.

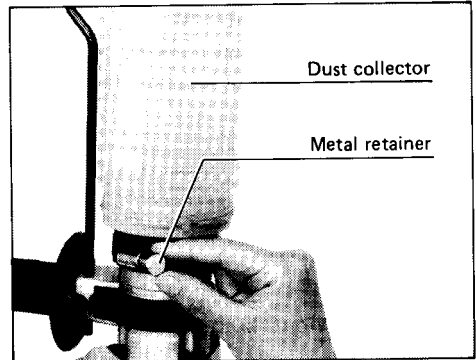

Drilling in wood or metal

Set the change lever for "rotation only." Use the optional drill chuck and chuck adapter for drilling up to 13 mm (1/2") in metal and up to 30 mm (1-3/16") in wood. To install the drill chuck and chuck adapter, refer to "installing or removing drill bit".

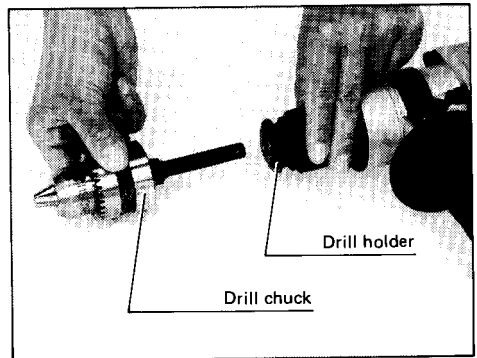

CAUTION:

When the drill chuck is installed on this tool, do not use "rotation with hammering" action. The drill chuck and chuck adapter may be damaged.

Core bit (optional accessory)

Screw the core bit on the adapter. Install the core bit and adapter on the tool in the same manner as a drill bit.

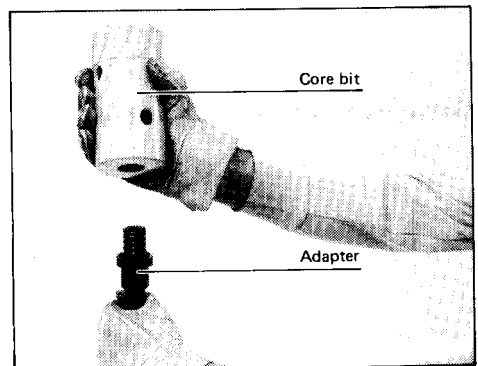

Install the center bit.

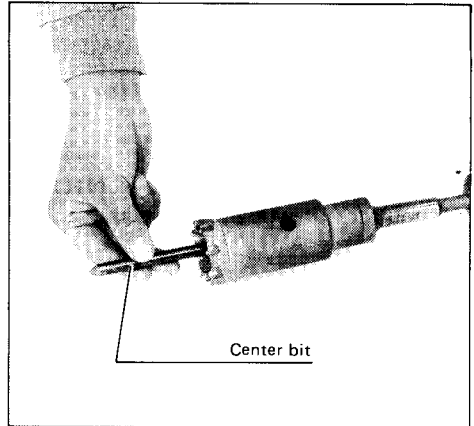

Rest the core bit on the concrete and turn the tool on. Once the core bit has cut a shallow groove into the concrete, remove the center bit. Then resume drilling.

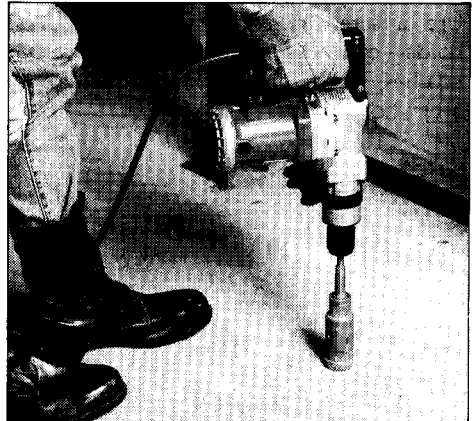

To remove the core bit, hold the adapter with the wrench, insert the rod into the hole in the core bit and tap with a hammer to unscrew.

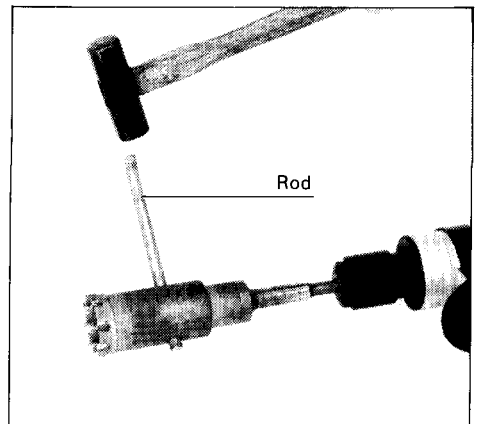

MAINTENANCE

CAUTION:

Always be sure that the tool is switched off and unplugged before attempting to perform inspection or maintenance.

Replacing carbon brushes

When the resin insulating tip inside the carbon brush is exposed to contact the commutator, it will automatically shut off the motor.

When this occurs, both carbon brushes should be replaced at the same time. Use only identical carbon brushes.

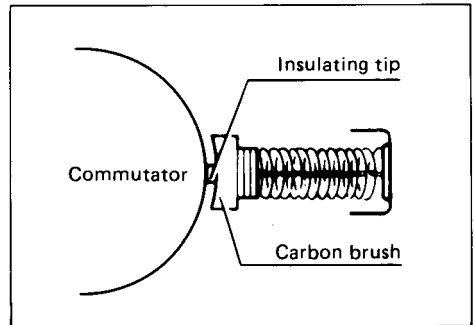

Use a screwdriver to remove the brush holder caps. Take out the worn carbon brushes, insert the new ones and secure the brush holder caps.

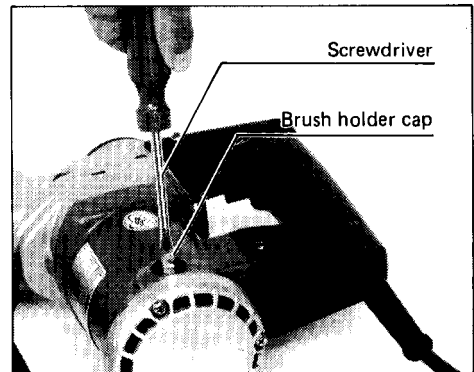

Lubrication

This tool requires no hourly or daily lubrication because it has a grease-packed lubrication system. It should be relubricated after every 6 months of operation. Send the complete tool to Makita Authorized or Factory Service Center for this lubrication service. However, if circumstances require that you should lubricate it by yourself, proceed as follows.

Run the tool for several minutes to warm it up. Switch off and unplug the tool. Remove the crank cap using a Makita lock nut wrench 35 (optional accessory). Rest the tool on the table with the bit end pointing upwards. This will allow the old grease to collect inside the crank housing. Wipe out the old grease inside and replace with a fresh grease (30 g; 1 oz). Use only Makita genuine grease (optional accessory). Filling with more than the specified amount of grease (approx. 30 g; 1 oz) can cause faulty hammering action or tool failure. Fill only with the specified amount of grease. Reinstall the crank cap and tighten with the lock nut wrench. Do not tighten the crank cap excessively. It is made of resin and is subject to breakage.

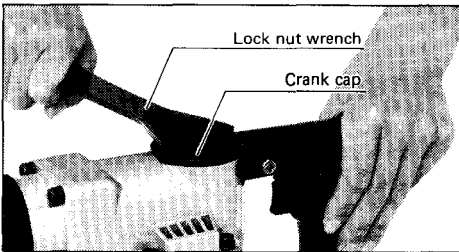

Sharpening tungsten-carbide tip bit

When your bit becomes dull, use an ordinary bench grinder with a wheel made of silicon carbide to sharpen it.

CAUTION:

- Be sure to maintain the original angles of the tip. Especially without 60° chamfering, the tungsten-carbide tip may be damaged.
- Do not quench the bit in water or oil.
- Do not grind the sides B and C.

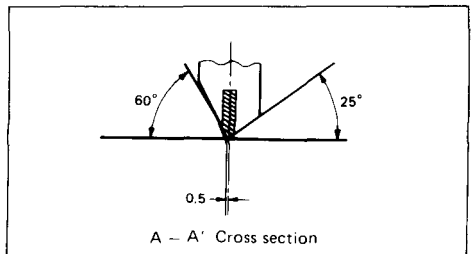
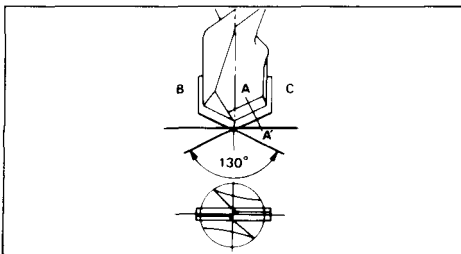

To maintain product SAFETY and RELIABILITY, repairs, any other maintenance or adjustment should be performed by Makita Authorized or Factory Service Centers, always using Makita replacement parts.

ACCESSORIES

CAUTION:

These accessories or attachments are recommended for use with your Makita tool specified in this manual. The use of any other accessories or attachments might present a risk of injury to persons. The accessories or attachments should be used only in the proper and intended manner.

● Tungsten-carbide tip bits



Part No.	Diameter	Overall length
791180-A	3/16"	4-1/2"
791182-A	3/16"	6"
791181-A	1/4"	4-1/2"
791183-A	1/4"	6-1/4"
791184-A	5/16"	6-1/4"
791185-A	3/8"	6-1/4"
791194-A	3/8"	12-1/2"
791186-A	7/16"	6-1/4"
791187-A	1/2"	6-1/2"
791195-A	1/2"	12-1/2"
791188-A	9/16"	10-1/2"
791189-A	5/8"	9-1/4"
791196-A	5/8"	12-1/2"
791190-A	11/16"	9-1/2"
791191-A	3/4"	9-1/2"
791197-A	3/4"	12-1/2"
791192-A	7/8"	9-1/2"
791193-A	1"	10"

● Drill chuck S13

Part No. 763055-3



● Chuck adapter

Part No. 321637-3



● Chuck key S13

Part No. 763411-7



● Blow-out bulb

Part No. 765009-6



● Hex wrench 5

Part No. 783203-8



● Lock nut wrench 35

Part No. 782407-9



● Hammer grease 30 g; 1 oz.

Part No. 181490-7



● Bit grease 100 g; 3.5 oz.

Part No. 181573-3



● Dust collector assembly

Part No. 122360-1



● Steel carrying case

Part No. 181798-9



25 mm (1") ROTARY HAMMER Model HR2511

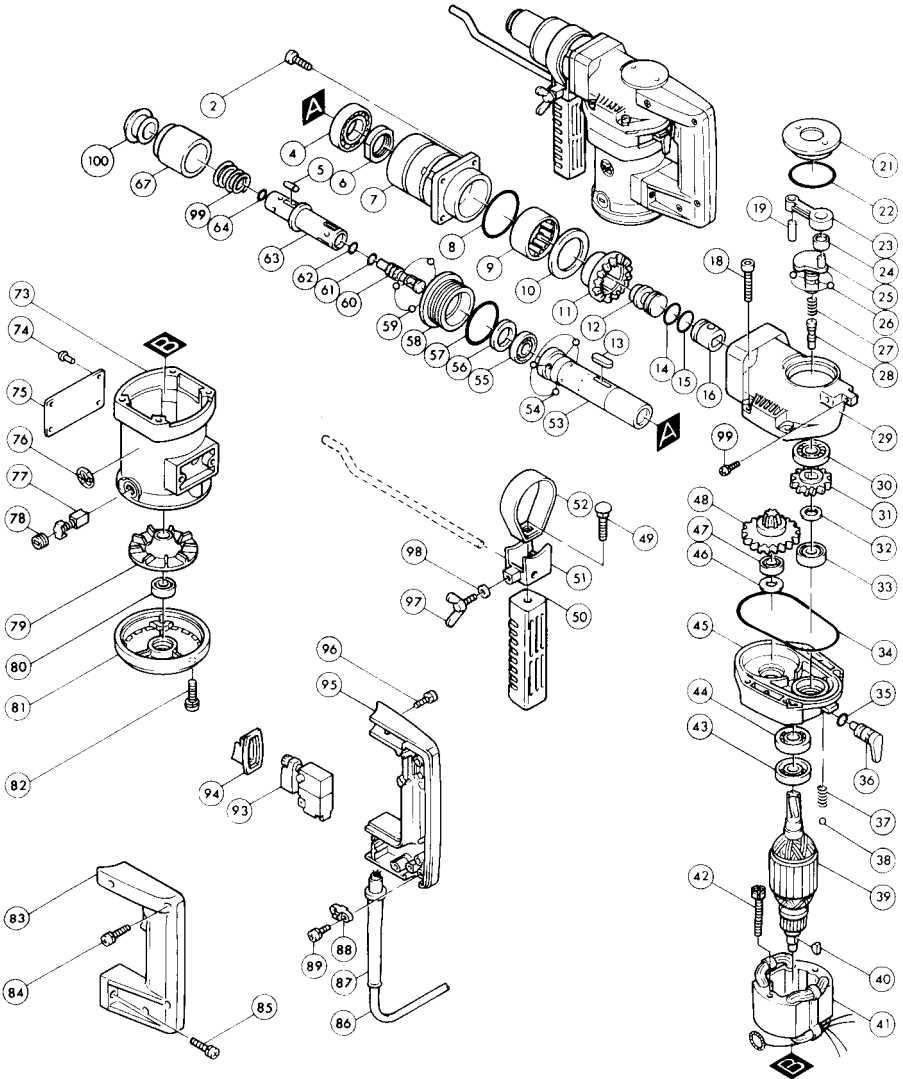

Note: The switch and other part configurations may differ from country to country.

ITEM NO.	NO. USED	DESCRIPTION	ITEM NO.	NO. USED	DESCRIPTION
MACHINE			MACHINE		
2	4	Hex. Socket Head Bolt M6x25 (With Washer)	48	1	Torque Limiter
4	1	Ball Bearing 3009	49	1	Cap Square Neck Bolt M8x35
5	2	Roller 6.5	50	1	Grip 32
6	1	Nut M30.3-36	51	1	Grip Base
7	1	Barrel	52	1	Belt
8	1	O Ring 48	53	1	Cylinder Liner 25
9	1	Needle Bearing 3516	54	3	Steel Ball 6.4
10	1	Flat Washer 35	55	1	Oil Seal 21
11	1	Spiral Bevel Gear 33	56	1	Felt Ring 20
12	1	Striker	57	1	O Ring 44
13	1	Key 4	58	1	Seal Holder
14	1	O Ring 19	59	3	Steel Ball 6.4
15	1	O Ring 19	60	1	Impact Bolt
16	1	Piston	61	1	O Ring 10
18	4	Hex. Socket Head Bolt M6x45	62	1	O Ring 10
19	1	Pin 6	63	1	Drill Holder
21	1	Crank Cap	64	1	O Ring 10
22	1	O Ring 44	67	1	Change Ring
23	1	Rod	73	1	Motor Housing
24	1	Needle Bearing 810	74	4	Rivet 0-5
25	1	Crank Shaft	75	1	Name Plate
26	2	Steel Ball 5.6	76	1	Label
27	1	Compression Spring 6	77	2	Carbon Brush
28	1	Change Pin 8	78	2	Brush Holder Cap
29	1	Crank Housing	79	1	Fan 85
30	1	Ball Bearing 6002	80	1	Ball Bearing 608LB
31	1	Helical Gear 36	81	1	Bearing Box
32	1	Flat Washer 15	82	3	Pan Head Screw M5x28 (With Washer)
33	1	Ball Bearing 6902	83	1	Handle Set (With Item 95)
34	1	O Ring 90	84	3	Pan Head Screw M5x25 (With Washer)
35	1	O Ring 7	85	2	Pan Head Screw M6x25 (With Washer)
36	1	Change Lever	86	1	Cord
37	1	Compression Spring 2	87	1	Cord Guard
38	1	Steel Ball 4	88	1	Strain Relief
39	1	Armature	89	2	Pan Head Screw M4x18 (With Washer)
40	1	Woodruff Key 3	93	1	Switch
41	1	FIELD ASSEMBLY	94	1	Dust Cover
42	2	Hex. Bolt M5x45 (With Washer)	95	1	Handle Set (With Item 83)
43	1	Oil Seal 13	96	2	Pan Head Screw M6x18 (With Washer)
44	1	Ball Bearing 6200	97	1	Wing Bolt M5x15
45	1	Gear Housing	98	1	Rubber Washer 4.5
46	1	Thin Washer 15	99	1	Conical Compression Spring 21-25
47	1	Ball Bearing 608	100	1	Cap 34

Note: The switch and other part specifications may differ from country to country.

MAKITA LIMITED ONE YEAR WARRANTY

Warranty Policy

Every Makita tool is thoroughly inspected and tested before leaving the factory. It is warranted to be free of defects from workmanship and materials for the period of ONE YEAR from the date of original purchase. Should any trouble develop during this one-year period, return the COMPLETE tool, freight prepaid, to one of Makita's Factory or Authorized Service Centers. If inspection shows the trouble is caused by defective workmanship or material, Makita will repair (or at our option, replace) without charge.

This Warranty does not apply where:

- repairs have been made or attempted by others;
- repairs are required because of normal wear and tear;
- The tool has been abused, misused or improperly maintained;
- alterations have been made to the tool.

IN NO EVENT SHALL MAKITA BE LIABLE FOR ANY INDIRECT, INCIDENTAL OR CONSEQUENTIAL DAMAGES FROM THE SALE OR USE OF THE PRODUCT. THIS DISCLAIMER APPLIES BOTH DURING AND AFTER THE TERM OF THIS WARRANTY.

MAKITA DISCLAIMS LIABILITY FOR ANY IMPLIED WARRANTIES, INCLUDING IMPLIED WARRANTIES OF "MERCHANTABILITY" AND "FITNESS FOR A SPECIFIC PURPOSE," AFTER THE ONE-YEAR TERM OF THIS WARRANTY.

This Warranty gives you specific legal rights, and you may also have other rights which vary from state to state. Some states do not allow the exclusion or limitation of incidental or consequential damages, so the above limitation or exclusion may not apply to you. Some states do not allow limitation on how long an implied warranty lasts, so the above limitation may not apply to you.

Makita Corporation

3-11-8, Sumiyoshi-cho,
Anjo, Aichi 446 Japan

883399D068

PRINTED IN JAPAN

1995-3-N

Free Manuals Download Website

<http://myh66.com>

<http://usermanuals.us>

<http://www.somanuals.com>

<http://www.4manuals.cc>

<http://www.manual-lib.com>

<http://www.404manual.com>

<http://www.luxmanual.com>

<http://aubethermostatmanual.com>

Golf course search by state

<http://golfingnear.com>

Email search by domain

<http://emailbydomain.com>

Auto manuals search

<http://auto.somanuals.com>

TV manuals search

<http://tv.somanuals.com>