

Mamiya

645 *PRO*



Instructions

Congratulations on your purchase of the Mamiya 645 PRO

Mamiya pioneered the 6x4.5 film format and introduced the world's first 645 SLR in 1975. The 645 PRO is the latest masterpiece in this series and incorporates all the latest mechanical, electronic and optical advances. Its external appearance, too, has been modernized and its ergonomic design further enhanced.

We are sure that you will enjoy the many advantages this camera and its accessories offer and want to particularly mention:

The 645 PRO has a built-in self-timer (delayed shutter release) which will also facilitate time exposures. Attaching special leaf shutter lenses will automatically set the focal plane shutter to $1/8$ sec. Heavy duty gears connect to the improved Power Drive Grip WG401. This grip also automatically cocks the leaf shutter lenses and permits remote control.

The AE Prism Finder FE401, specially created for this camera, automates exposure and shows LED safety signals. 35mm film holders now come with panoramic adapters. A super fast 300mm f/2.8 APO lens was also designed for this camera.

We are convinced that your camera will serve you well, because we have designed it for heavy professional use. However, we ask you to please read all operating instructions carefully before you put your equipment to work, in order to ensure proper operation and maximum results.

This manual covers the basic camera. Separate instructions are supplied with all system accessories, including lenses, finders, film holders, etc.

For additional information please feel free to contact your authorized Mamiya dealer or the Mamiya importer in your country.

Special Features of Mamiya 645PRO.....	3	Film Transport and Film Unloading	26
Names and Function of Parts.....	7	Using the Self-timer/Delayed Shutter Release. ...	27
Attaching and Removing Lenses	10	Multiple Exposures	27
Attaching and Removing Roll Film Holders	11	Time Exposures	28
Attaching and Removing Viewfinders	12	Mirror Lock-up Photography	29
Attaching and Removing the Film Advance		Infrared Photography	30
Crank.....	13	Using Flash	31
Inserting Battery and Battery Check	14	Using a Tripod	32
Shutter Release Selector.....	16	Holding the Camera Steady and Securely..	33
A Trial Familiarization Test	17	Attaching and Removing the Neck Strap	34
Film Loading.....	18	Specifications	35
Advancing Film to the First Exposure.....	21	Trouble Shooting	37
Aperture Ring/Stop-down Operation	23	Basic Accessories	39
Focusing	24	System Chart	41
Depth-of-field	25	Storing and Checking the Camera	42

Features and specifications subject to change without notice.

Special Features of the Mamiya 645 PRO

1 3 x More Negative Area Than the 35mm Format Plus Superior Image Quality From Mamiya World-Class Lenses

The 6x4.5cm format offers approx. 3 times more image area than the 35mm (24x36mm) format, Man's vision is horizontal and rectangular.

Film Holders are rectangular and so are most pictures in them. The 6x4.5 format is also large enough to be viewed without a magnifier and its aspect ratio (horizontal / vertical) is ideal, requiring minimum cropping. Mamiya's high performance medium format lenses assure sharpness and beautiful color fidelity.

2 Sturdy, Versatile, Safe and Highly Reliable Body - Tailored to Satisfy Pro Needs -

Introduced in 1975 to not only provide an alternative to the 35mm format, but to afford the user with advanced versatility given its much larger format, the Mamiya 645 Series is constantly being upgraded. Elements such as speed and handling plus a host of other special features have been enhanced to satisfy the needs of most demanding professionals.

Two new convenient safety features have been added to the 645 PRO in the form of state-of-the-art optoelectronics which immediately identifies problems with the shutter (i.e. when it will not release) when the AE Prism Finder FE401 is used. Whether these malfunctions develop from failure to draw out the Dark Slide, or if there are problems in film take-up, the LED will indicate the source of the trouble. With these new advancements, Mamiya believes the most demanding pro will be more than satisfied with the new edition 645.

3 Enhanced Interchangeable Roll Film Holder System - Enables Polaroid and Even 35mm Panoramic Photography -

The 645 PRO features an interchangeable film holder system capable of using a far wider range of roll film holders than before. Depending on the application, the system can be quickly attached to or detached from the camera, ensuring the ability to catch even fast changing scenes. It also features fail-safe devices including, for example, one that warns when you have failed to take out the dark slide when the AE Prism Finder FE401 is being used.

4 Interchangeable Viewfinders

1. AE Prism Finder FE401

The AE (automatic exposure) Prism Finder FE401 features three modes of TTL metering, including automatic switching from center-weighted averaging to spot metering. It also has a $\pm 3EV$ exposure compensation adjustment.

2. Prism Finder PF401

The Prism Finder PF401 is without metering electronics and designed for manual photography mode. Both Prism Finders show an unreversed, upright image and are ideal for eyelevel photography.

3. Waist Level Finder N

The Waist level Finder N is desirable for low angle photography and particularly for horizontal composition. A self erecting hood with built-in magnifier shields groundglass from all ambient light. A built-in sportsfinder permits eyelevel viewing and is ideal for action photography.

5 Bright, Dynamic Images Visible on the Focusing Screen

- 5 Selectable Types Available -

The 645 PRO can reproduce bright, dynamic and sharp images on the focusing screen, enabling optimum composition to be obtained according to the photographic purpose. In addition, the 645 PRO greatly enhances focusing.

5 types of focusing screens are available to facilitate photographing a wide variety of subjects.

6 A Comprehensive Series of Interchangeable Lenses - Sharp Images and Outstanding Color Balance -

There are an amazing variety of interchangeable lenses in the PRO 6 x 4.5 format series. Mamiya has concentrated an all-out effort on the systematic production of lenses in an effort to satisfy a multitude of needs. All lenses are multi-coated to eliminate flare and ghosting even under the most adverse light conditions. While the series now also features three leaf shutter lenses, all lenses exhibit the utmost in color balance, high resolu-

tion and crystal clear definition. A feature lens is the new 300mm f/2.8 APO lens which eliminates chromatic aberration and produces photos with the sharpest definition. Given the wide variety of lenses in the 645 PRO Series, they greatly expand the world of images that are possible.

7 Auto winding with the Power Drive Grip WG401

This Power Drive Grip WG401 has been specially designed for heavy duty, motorized operation with the 645 PRO. It also permits automatic shutter cocking of the leaf shutter lenses and can be remote controlled. Another feature, not available previously is the following:

When attaching a partially exposed film holder (in which the film has not been advanced to a new frame), to the 645 PRO equipped with the Power Drive Grip WG401, a

built-in camera mechanism will automatically advance the film to the next frame, when the shutter release is activated, either on the camera body or on the Power Drive Grip WG401.

8 New Automatic Leaf Shutter Lenses for added versatility. **55mm (Wide Angle), 80mm (Standard) 150mm (Telephoto) lenses**

These lenses are all in Seiko #0 shutter, offer the advantages of syncroflash photography at all shutter speeds 1/30, 1/60, 1/125, 1/250 and 1/500sec. The optional Power Drive Grip WG401 will automatically cock the shutters as it transports the film and moves the mirror.

The camera's focal plane shutter must be set at 1/8 sec. for leaf shutter mode operation. The leaf shutter lenses can do it automatically.

9

A Broad Accessory System For Specialized Applications

A useful accessory system to serve the specialized needs of the photographer. It includes Auto Bellows and Auto Extension Rings for close-up and copying work; Infrared Remote Control for studio and nature photography; External Battery Case for operating in cold surroundings; Camera Grips for convenient holding and more.

10 Other Features

<Mirror Lock-up>

After focusing, the Mirror can be locked up before making an exposure. This is convenient when the camera is used at slow shutter speeds and is mounted on a tripod for telephotography, copy work, etc., since even a very small amount of vibrations should be eliminated.

<Self-timer>

Self-timer for delayed shutter release. When activated it will light a red pilot lamp in the front of the camera for eight seconds and will blink for two seconds before triggering the shutter.

<Time Exposure>

Time exposures are made by utilizing the Self-timer and the "B" shutter setting. A new power saving circuit design switches the battery off and extends its life.

Names and Functions of Parts

Focusing Screen N

Aperture Ring Coupling Pin

This pin is fitted into the Exposure Meter Coupler of the lens, to transmit the aperture data to the AE Prism Finder.

Battery Check Lamp

Focusing Screen Release Pin

When you want to change the screen, slide this pin to the left and remove the screen.

Shutter Release Selector

Align the white index dot on the selector collar with the white square dot in the center for normal use. When the collar is turned to the red dot, the release is locked. To use the Self-timer, set it to .

Shutter Release Button

Mirror

* Never touch the surface of the mirror.



13 Gold Plated Contacts

These contacts interface the AEPrism Finder with the ISO dial on the film holder and the shutter speeds.

Hot-shoe (X contact)

A cordless flash can be used with this shoe.

Flash Sync Terminal

Flash cord and optional Terminal Adapter RA401 can be connected to this terminal.

Mirror Lock-up Lever

Neck Strap Lug

Lens Release Button

Auxiliary Release Contact

When the cover is moved to the left, the contact appears. This contact is used for connections of external releases such as a special hand grip and remote control unit.

Battery Check Button

LED displays the present battery condition.

Finder Coupling Panel (Front)

Finder Coupling Panel (Rear)

Electric Contact for Film Holder

This contact receives film sensitivity data from the film holder.

Film Holder Mount

Film Holder Coupling Pin Guide

Shutter Curtain

Exposures are controlled by opening and closing the curtain

• Never touch the surface of this curtain.

Film Transport Gear

Film Holder Mounting Bracket

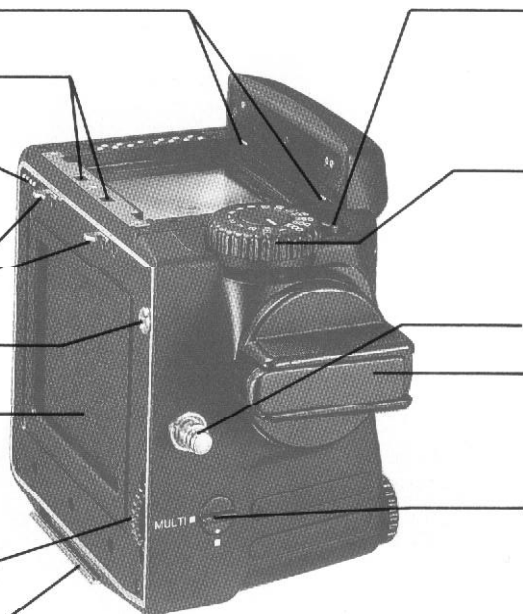

Shutter Speed Dial Lock Release Button

This button is used for unlocking the Shutter Speed Dial from an AE position.

Shutter Speed Dial

This dial selects the shutter speed, and switches the operation mode from AE to manual photography.

Neck Strap Lug

Film Advance Crank

A Single complete turn cocks the shutter and advances the film for each exposure.

Multiple Exposure Lever

When this lever is set at "MULTI", film is not advanced even when the Film Advance Crank is turned. thus allowing multiple exposures on the same film frame.

Names and Functions of Parts

Focusing Ring

This ring adjusts the focus.

AM Lever

When set to "M" it permits you to check depth of field. Normally always leave it in "A" position.

Tripod Socket

1/4" tripod socket. To convert to a 3/8" socket, remove the small screw in the base of the socket. Then remove the bushing. See page 32.

Distance Scale

The camera to subject distance can be set or confirmed with this scale.

Lens Alignment Dot

Depth-of-field Scale

Provides a quick reading of depth-of-field for various apertures and distances.

Exposure Meter Coupler

This coupler is engaged with the Aperture Ring Coupling Pin, transmitting diaphragm information to the AE Prism Finder.

Battery Chamber Cover

Battery Chamber Cover Latch

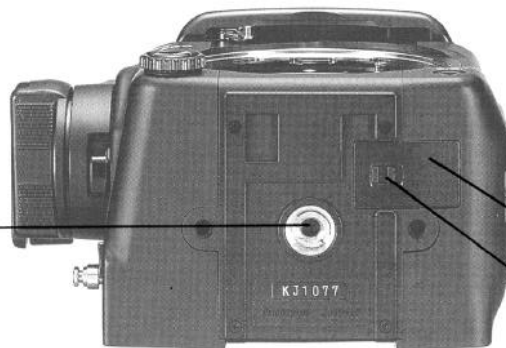

Attaching and Removing Lenses

Removing the Front Body Cap and Rear Cover



First remove the Front Body Cap in the direction of the arrow, while pushing the Lens Release Button (A) backwards as indicated by arrow. Rear Body Protective Cover can be readily removed by depressing the part of (E) as shown in the illustration.



Attaching the Lens

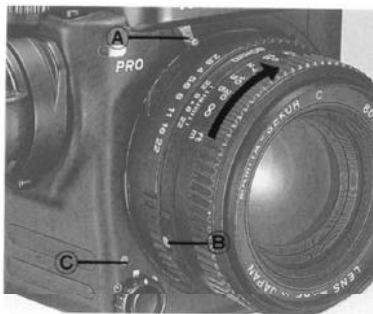

Line up red Lens Alignment Dot (B) against red camera Alignment Dot (C) and gently insert the lens into the camera body. Then turn the lens clock wise, as indicated by arrow, until it clicks into place. Make sure that the Aperture Ring Coupler Pin is engaged with the Exposure Meter Coupling Pin (A), which sticks out under the Mamiya name plate of the camera.

★ When the Aperture Ring Coupler Pin is engaged by the exposure meter coupling pin lever, F/stop data is conveyed to the AE Prism Finder.

Removing the Lens.



While pushing lens release button backwards, turn lens counterclockwise. (Same procedure as removing body cap).

Attaching and Removing the Roll Film Holders

Attaching the Roll Film Holder

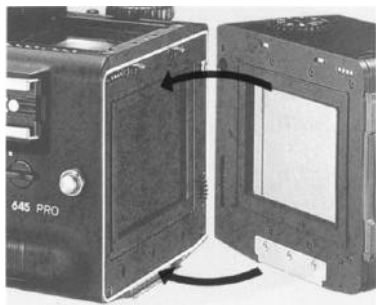

★ Remove the Roll Film Holder Cover.

1. While spanning the Roll Film Holder between your thumb and middle finger, holding it on the rubberized finger rests, carefully align its Film Holder Mounting Bracket with the corresponding center clip of the camera body.
2. While keeping this alignment, press the upper part of the Roll Film Holder against the camera body, so that it clicks into place by engaging the spring loaded twin camera catch.

Removing the Roll Film Holder

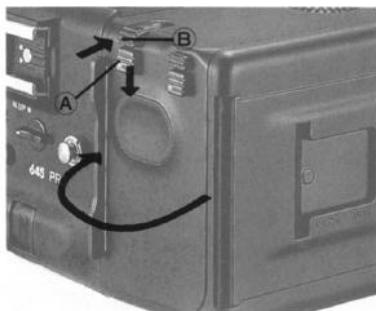

1. Insert the Dark slide into the slot marked by White Lines on the side of the holder.
2. Push the lower one of the Film Holder Detaching Lock Release Button (A) downward, while simultaneously pushing the Film Holder Detaching Button (B) inward.

★ If the Dark Slide is not inserted, the safety lock will prevent the holder from being removed.

★ The Dark Slide can be inserted in the Roll Film Holder up to the Green Line, marked on the slide, without affecting the image.

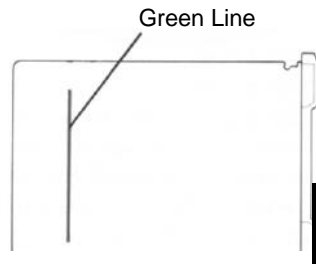

Attaching and Removing the Viewfinder

The same procedure applies to all finders. The illustration shows the AE Prism Finder FF401.

Attaching the Finder.

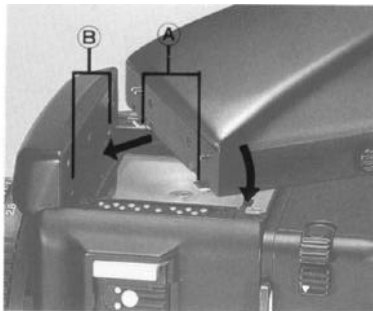



Lift the Upper Cover from the camera body.

Insert the Attaching Latches **(A)** of the finder into the Finder Coupling Panel **(B)** in the front wall of the body. Press the finder down until the rear latch locks securely in place.

Removing the Finder



Spanning the finder with your fingers, push the button on its right side marked with a downward pointing arrow , downward, while pushing the other button, on the left side , inward.

Removing and Attaching the Film Advance Crank

Removing the Crank

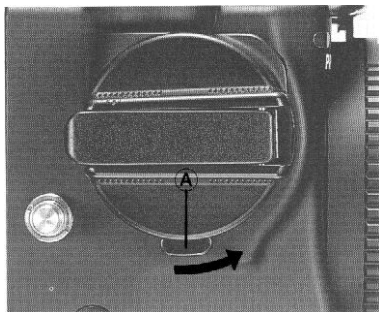

Push the lock Lever (**A**) on its bottom in a forward direction as far as it will go (see illustration).

Attaching the Crank

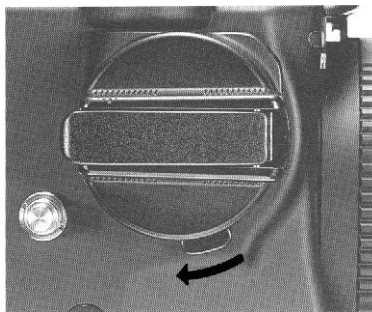

With the flat part, having a White Index Line, on top, line the Crank up against its mounting plate on the side of the body and push Film Advance Crank Lock Lever backward.

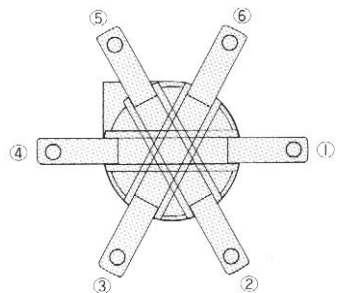

You may choose six different crank starting positions to suit your preference. The orientation of the crank proper against its base, before it is attached to the camera, will be maintained when the entire assembly is locked into place.

Inserting and Checking the Battery

Inserting the Battery The camera will not function without a battery

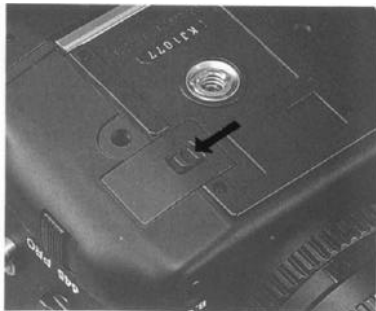

The camera will not function without a battery

With your fingernail, pull the Battery Chamber Cover latch, on the bottom of the camera body, as indicated by the arrow in the illustration. Lift the cover off. The camera requires a 6V alkaline, silver oxide or lithium battery. It is a good idea to wipe the battery terminals before insertion to assure proper contact. Observe po-



larity. + position is marked in battery cavity. Insert the ⊖ side first at a steep angle and then push entire battery into place, making sure that the lift ribbon wraps around battery. Close cover by inserting twin-prong end first and pushing it down.

★ **Be particularly careful not to let the lift ribbon cover the ⊖ terminal.**

Checking Battery



Press Battery Check Button "B.C." (A) on lower front of the camera. Battery Check Lamp (B) on top opposite side should light. Bright light indicates good condition. Blinking light means replace battery. No light means battery is dead or improperly inserted.

Important:

1. The sealed, new battery which is supplied with this camera may have been subject to storage conditions which have reduced its service life. Therefore it is desirable to replace it with a fresh battery as soon as possible.
2. Carefully wipe the battery contacts before inserting into the chamber. Failure to do so may result in poor electrical contact and consequent malfunctioning of the camera.
3. Always remove battery when camera is not used for a while. Always carry spare batteries.
4. Battery life differs, depending on type, age, storage condition, ambient temperature, frequency of use etc.

Battery strength will be indicated by whether the light:

Glows Battery strength is sufficient.

Blinks Battery capacity has dropped below the allowable level. (Replace the battery.)

Does not light The camera will not work. (Replace the battery.)

Shutter Release Selector

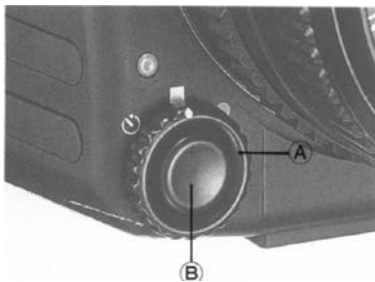

For normal operation set the White Dot of the Shutter Release Selector **(A)** against the White Square Dot \square . When set to the Red Dot \bullet the Release Button is locked.

★ Select this mode if the camera will be idle for a period and to prevent accidental shutter release. Also when the Power Drive Grip is used.

When set to the yellow clock symbol ⌚ the self-timer is operative. See page 27 and 28 for further instructions.

Operating the shutter Release Button

1. The Shutter Release Button **(B)** functions in two steps. Gentle pressure will light the metering information display if the AE Prism Finder is used. Continued pressure will release the electromagnetic shutter.

2. If the film is not completely advanced, if the Dark Slide is not withdrawn or if the battery is dead, the shutter will not function, even when the Shutter Release Button is pressed. This will also be the case if the Shutter Speed Dial is set to "A" or "AEL" when the AE Prism Finder is not attached.

3. After releasing the shutter, the Film Advance Crank will callably unlock and be ready to advance the film.

A Trial Familiarization Test

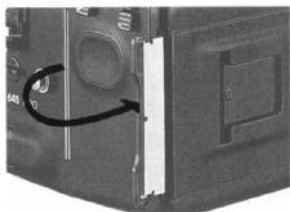

1. Attach the Roll Film Holder to the camera body.
2. Pull out the Dark Slide and place it into its Storage Slot.



3. Set the Shutter Speed Dial to any other position than "A" or "AEL". When the AE Prism Finder is not mounted on the camera, the shutter will not release if the Shutter Speed Dial is in the "A" or "AEL" position.

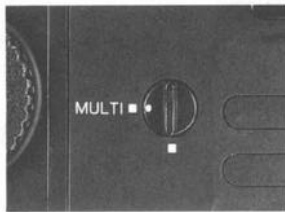

4. Set the Multiple Exposure Lever on the body to the "MULTI" position.

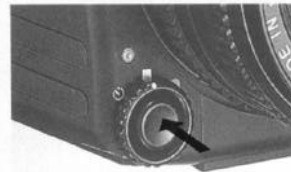

5. Set the Shutter Release Selector to "□" (normal mode), and press the Shutter Release Button.
6. After the shutter has been released, advance the Film Advance Crank one complete revolution and the next frame will be ready.

★ When only the body is tested, the familiarization checkout can be made either in the "MULTI" or □ (normal mode).

The empty film spool included with the film holder is supplied with a vinyl tube. When placed in the take-up compartment it engages the film sensor and makes the holder function as if it is loaded with film. Please remove the tube after your test.

Film Loading

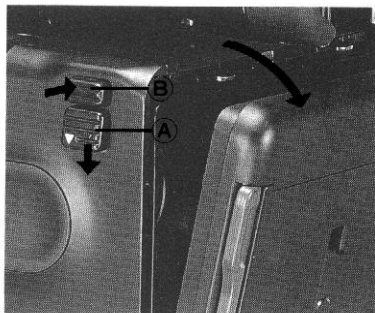

1. While pushing the Back Cover Lock Release Button (A) downward, press the Back Cover Opening Button (B), and the Back Cover will open.

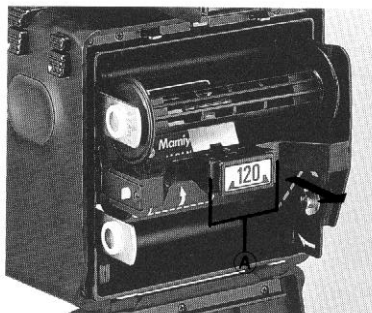

2. While squeezing in on both sides of the Release Latch (A) pull the Roll Film Insert out of the camera body. At that time, move the empty spool in the upper part down to the lower spool compartment.



3. Align the right-hand side of this empty spool with the lower Spool Stud (A) (convex). Slide the spool into position making sure that the left-side of the spool is properly held by the Spool Clip.

When you load film for the first time, remove and discard the protective paper cover which is attached to the film rails in the roll film holder.

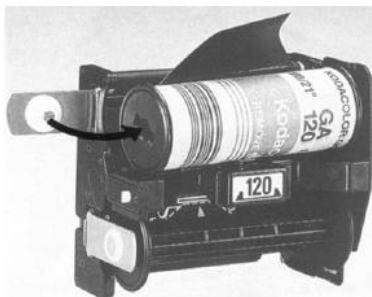

4. In the same manner, insert a roll of film in the upper compartment. At that time, check that the film leader paper is set as shown in the photo above. (The leader paper inside is facing outward on the pressure plate. Note that the film direction is wrong if the leader paper is facing inward.)



5. Pull out some of the leader paper. Insert the tip of the leader paper into the slot of the lower Take-up Spool.

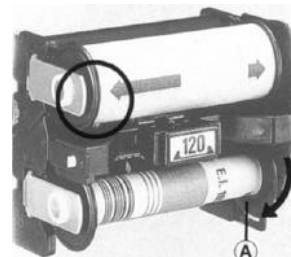

Gently rotate the take-up spool as shown in the photo until the start mark on the leader paper is aligned with the start mark (Δ) on the spool clip.

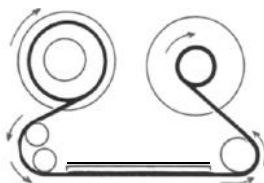

★ **Correctly align the start marks with each other, making sure that the film feeds properly. When improper feeding occurs, the proper number of exposures may not be taken.**

★ **Avoid exposing the film to direct sunlight when inserting or removing film.**

Inserting the Roll Film Insert

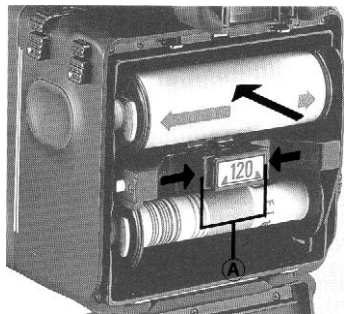

Insert the loaded Roll Film Insert into the holder, the film roll on top, while squeezing on both sides of the Release Latch **(A)** as shown in illustration. Make sure that it is properly seated and is locked in place. Then close cover by firmly pressing its top against the Roll Film Holder.

*** To close the Back Cover, firmly press the top of the back cover on both sides.**

Film Speed (ISO) Dial

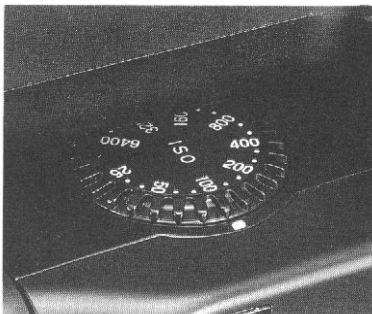

Each film holder has this important feature. It electronically interfaces the film holder with the AE Prism Finder, the focal plane shutter and the lens diaphragm, for exposure automation.

This eliminates the need of having to manually reset the meter, every time you change film holders loaded with different films. Therefore make it a routine to always set this dial with the speed of the loaded film.

Memo Clip

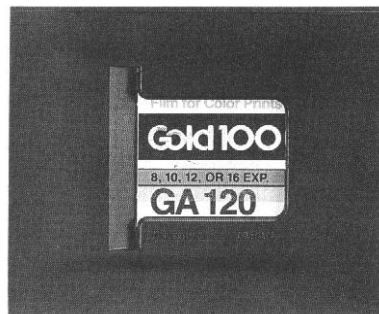

The Memo Clip on the back of the Roll Film Holder Cover accepts the box top of the film carton and can also be used for other reminders.

Film Speed Index of film holder ISO 25 · · 50 · · 100 · · 200 · · 400 · · 800 · · 1600 · · 3200 · · 6400

(32)(40) (64)(80) (125)(160) (250)(320) (500)(640) (1000)(1250) (2000)(2500) (4000)(5000)

Advancing the Film to the First Frame

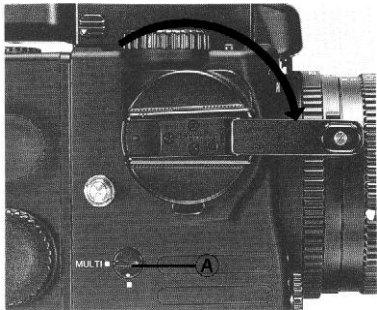

Attach the loaded Roll Film Holder to the camera. Remove Dark Slide and store it. Turn the Multiple Exposure Lever **(A)** to its normal position, White Dot against White Square. Turn the Film Advance Crank until it stops. The number "1" will now appear in the Film Counter Window. The Focal Plane Shutter and Mirror are now cocked and the camera is ready for the first exposure.

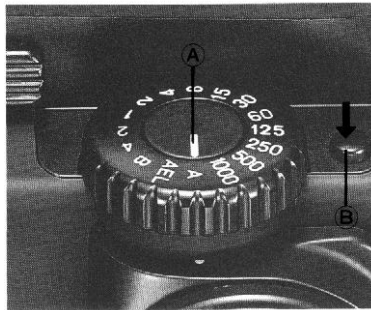

Set the desired shutter speed against the white index line **(A)** on the Shutter Speed Dial.

1. At the "A" and "AEL" settings, the Shutter Speed Dial is locked between these two positions.
2. To release this lock, turn the Shutter Speed Dial while pushing the Lock Release Button **(B)**.
3. At all other settings the dial can be rotated freely and each speed number will click into place.

Color Codes

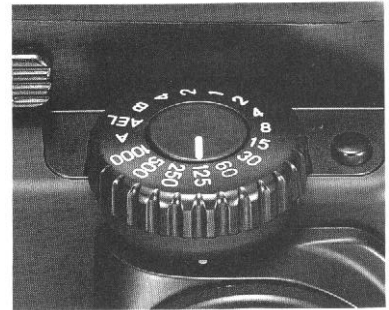

1. full seconds. All other numbers are fractional seconds. (i.e. 30 = 1/30 sec.)
2. The yellow B indicates Bulb. At this setting the shutter remains open as long as the release is pressed.
3. The red 60 (1/60 sec.) reminds you that it is the fastest permissible shutter speed setting when using electronic flash.

4. "A and "AEL" explained

"A (auto exposure) and "AEL" (auto exposure lock) setting must only be used when the AE Prism Finder is attached to camera.

1. If it is not attached and the dial is set to either of these positions, the shutter release will not work.

2. If it is not attached and the Self-Timer is activated, the Pilot Lamp will light for 10 seconds but the shutter will again not release.

If the Shutter Speed Dial is set between click stops either the higher or lower exposure speed may result.

Aperture Ring/Stop-down Operation



Set the desired f/stop on the Aperture Ring (A) by aligning the f/number with the red reference dot (B) in the center of the Scale Ring. The Aperture Ring has a click stop for each f/stop. In-between clicks can also be used.

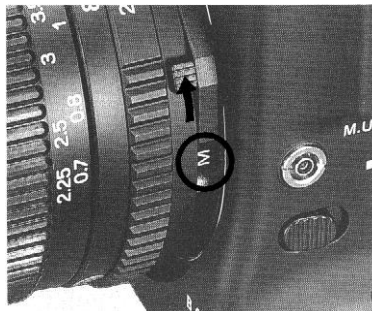

The effect the set f/stop will have upon the picture area can be confirmed on the Finder Screen. Move the AM Lever on the lens so that "M" becomes visible - the lens then can be stopped down to the preselected aperture.

* At position "A", the lens is always stopped down only when the shutter is being released with the aperture being open.

* During normal photography, set the AM Lever so that "A" is visible. At "M", focusing will be a little difficult.

* When using the AE Prism Finder, be sure to set the AM Lever on "A"; otherwise, correct exposure cannot be obtained.

* When aperture has been confirmed, be sure to reset the AM Lever to "A".

See "Depth-of-field" on page 25.

Focusing with the Standard Focusing Screen N Type E

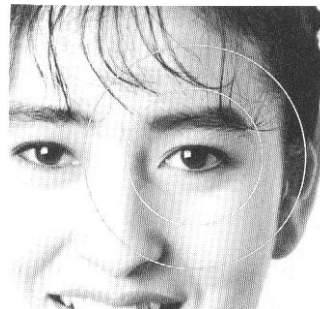
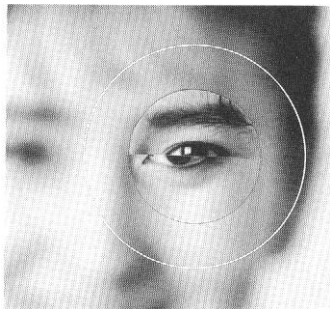

While looking through the viewfinder, turn the lens Focusing Ring until the most important subject part appears sharp and clear.

1. The camera comes equipped with a bright, Type E, Rangefinder/Micro-prism Focusing Screen. It features a center, split-image rangefinder spot and the subject is in sharp focus when the split images combine into one.

2. The microprism ring around the split-image center further facilitates focusing. The microprisms disappear only when the subject is in sharp focus.

3. The rest of the ground glass area can also be used for focusing.

* Interchangeable Focusing Screens

There are four additional focusing screens available for specialized applications. They are easy to interchange and come with instructions.

Depth of Field

Depth of field is defined as the zone of sharpness before and behind the plane of focus. It depends on camera subject/distance, focal length of lens, aperture setting and distance the lens is focused at.

Reading the Depth of Field Scale

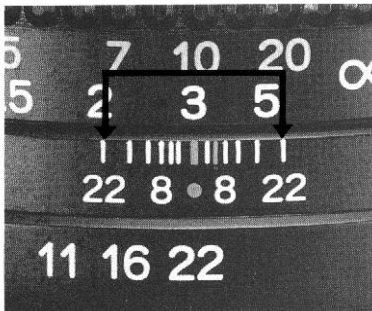

In addition to visual observation, the Depth of Field can be determined by using the Depth of Field Scale on each lens. f/stop numbers appear on both the right and left side of the scale ring. Simply read the figures which appear above the f/stop numbers on the distance scale of the lens.

For example, with the 80mm f/2.8N lens focused at 3m and the aperture set at f/22, the depth of field scale indicates that the zone of sharp focus will extend from about 2m to 6m.

Film Advance and Unloading Exposed Film

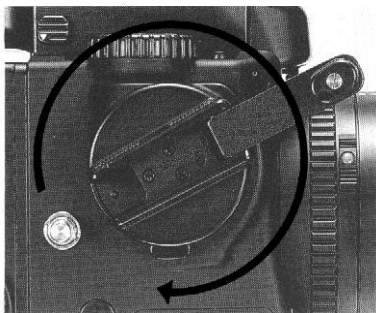

1. Giving the Film Advance Crank one complete turn, will cock the shutter and mirror and ready the camera for the next exposure.
2. When the film is completely exposed (15 exposures on 120, 30 on 220 film), the crank stop will disengage. Continue turning until the paper trailer is completely wound onto the take-up spool. (About five turns after the last exposure.)

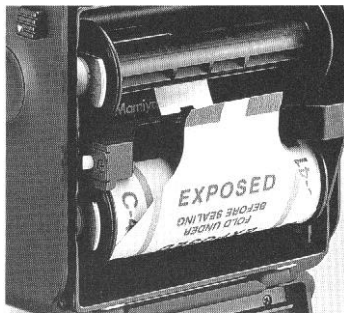

3. Open the Back Cover, and remove the Roll Film Insert. The Exposure Counter will return to S (start) automatically.
4. Pull the Spool Clip on the roll film insert out to remove the film.
5. Remove the film from the roll film insert; make sure that the film on the roll does not loosen, and seal immediately.

- * Move the empty spool from the top to the lower (take-up) compartment, ready for loading the next film roll.
- * Never load, unload or handle film in direct sunlight.



To use the Self-Timer, set the Shutter Release Selector to  and press the Shutter Release Button. The Battery Check Lamp will light for 8 seconds and blink for 2 seconds, whereupon the shutter will go off.

⚠ After using the self-timer mode, be sure to return the Shutter Release Selector to the White Square. (Normal mode.)

⚠ To override the self-timer, after having pressed the release, move the selector back to the white square.

*The Self-Timer can also be overridden by inserting the Dark Slide into the Film Holder or setting the camera Shutter Speed Dial to "B".

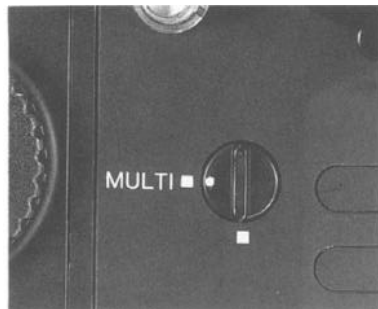

Aligning the white dot of the Multiple Exposure Lever with the yellow "MULTI" square, disengages the multiple exposure prevention mechanism, and the film will not advance after an exposure is made and the Film Advance Crank is turned. However, the shutter will be recocked, thus making multiple exposures possible. In this mode the Exposure Counter will not advance.

Time Exposures

★ To override the multiple exposure mode or to return to normal operation, be sure to return the lever's White Dot against the white square and then advance the film. (If you forget you will continue to make multiple exposures on the same frame.)



For time exposures set the Shutter Release Selector to  the self-timer mode, and set the Shutter Speed Dial to "B". Press the shutter release and both mirror and shutter

will stay open until the shutter release is pressed again. You may also use a cable release together with the cable release adapter. (The battery circuit will automatically switch off to save power.)

★ "B" can be terminated by shifting the Shutter Release Selector from  or the Shutter Speed Dial from "B".

Mirror Lock-up Photography

This is an important feature when the tripod mounted camera is used at slow or long exposure times and particularly also with use of long telephoto lenses. It eliminates the possibility of even the slightest "mirror bounce" which may affect image sharpness.

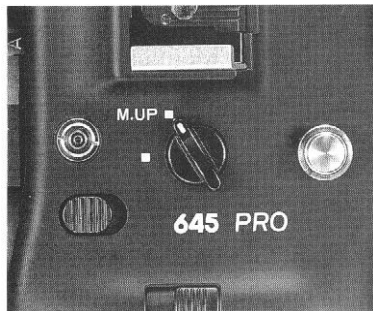

Move the Mirror-up Lever to the yellow "M.UP" square, after you have composed and focused your picture. This will raise the mirror and the viewfinder image will be blacked out. After use, return lever to normal (white square) position.

***When using the AE Prism Finder, set the Shutter Speed Dial to "AEL". Press the shutter release halfway and then lock the mirror up. If set to "A" and the mirror is locked up, "LT" (long time) will appear in the finder display and correct exposure cannot be obtained.**

*** When using a Leaf Shutter Lens, be sure to read the instructions accompanying it.**

Infrared Photography

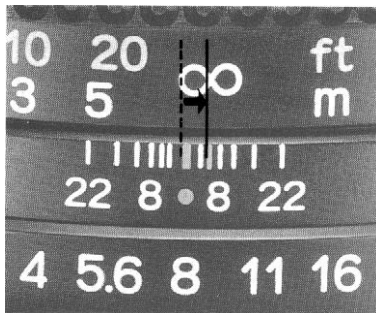

Infrared light rays - being of longer wavelength - focus at a slightly different plane and require the following adjustment:

1. Note the Red Index Mark against which you read your distance scale. The red infrared index mark is slightly to its right.

2. After focusing in the usual manner, read the distance scale and move it to the right to line up with the infrared index mark.

*** For proper filter and exposure information be sure to consult the instructions enclosed with infrared film.**

*** The A300mm f/2.8 APO lens for 645, being also corrected for infrared light rays, does not need an Index Mark for infrared.**

<Caution>

When using the Hot-shoe, be sure to put an appropriate Safety Cover over the X-sync terminal so that you won't receive a high voltage electric shock if the terminal is accidentally touched. (A Safety Cover is put on the X-sync terminal when the camera leaves the factory.)

1. When using an electronic flash, plug the synchronization cord into the Sync Terminal and set the Shutter Speed Dial to 1/60 sec. or slower.

✦ **The Mamiya 645 PRO has an X-sync terminal.**

Attach a shoe-mount flash to the hot-shoe of the camera or the Left Hand Grip GL401 (optional).

★ **Do not use a flash unit specifically dedicated for another camera. It may damage your 645 PRO.**
 ★ **If you use a flash unit whose flash duration is slower than 1/1000 sec., set the shutter speed dial to 1/30 sec. or slower.**

Flash Synchronization Chart

Sync. Terminal	shutter Speeds											
	1/1000	1/500	1/250	1/125	1/60	1/30	1/15	1/8	1/4	1/2	1	2
X	Cannot be used					Electronic flash						
	Cannot be used					MF Class						
	Cannot be used						M Class					

Using a Tripod

2. For MF and M bulbs, set the Shutter Speed Dial to 1/30 sec. or slower for the MF type, and 1/15 sec. or slower for the M type.

*** When using a flash, carefully read the instructions that come with the flash bulbs or flash unit to check for appropriate shutter speeds and to avoid malfunctions.**

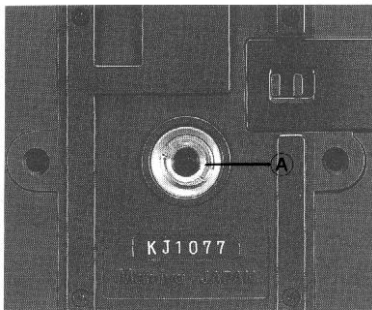

The Mamiya 645 PRO Tripod Socket accepts a standard 1/4" tripod mounting screw. For use with tripods having 3/8" mounting screws, first unscrew the small black philips head retaining screw in the center of the tripod socket. Then remove the 1/4" bushing with a thin coin. To reinstall the 1/4" bushing, reverse the process

Holding the Camera Steady and Securely

Eye-level Operation



Hold the camera as shown in the illustration, with its base resting on your left hand, the right hand supporting it from the side and top. Press both elbows against your body and activate the shutter release with a smooth, steady stroke.

Waist Level Operation



For waist level operation, it is desirable to have the Neck Strap attached and adjusted for your size. During exposure keep it taut and press the camera firmly against your body.

*** Handholding the camera is even easier using the Power Drive Grip WG401 or kept Hand Grip GL401.**

Attaching and Removing the Neck Strap

Attaching the Strap to the Camera

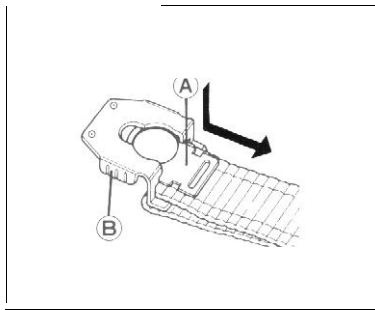

1. While pushing down, pull out the Neck Strap Fastener (A) of the attaching clip.

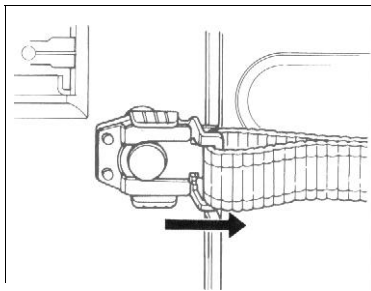

2. Place the hole of the strap fastener (A) over the Neck Strap on the camera body as illustrated, and pull until it clicks and locks into place.

Removing the Strap from the Camera

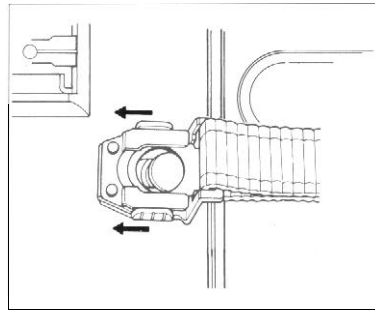

With your fingers, pull the Neck Strap Fastener (A) of the attaching clip upward and push part (B) in the direction of the arrow. The strap can now be removed.

*** When attaching the Strap to the Neck Strap Lug on the side of the camera with the Film Advance Crank, insert the neck strap fastener (A) into the lower part of the double slot.**

Mamiya 645 PRO Specifications

Camera type	6 x 4.5cm electronic focal-plane shutter SLR
Actual negative size	56 x 41.5mm
Film type	120 roll film (15 exposures) 220 roll film (30 exposures) Polaroid pack film (Polaroid 100, 600 series) 135 roll film in film cartridge
Film loading	Daylight loading-interchangeable film holders with film speed dial available
Standard lenses	Mamiya-Sekor C 80mm f/2.8N Mamiya-Sekor C 80mm f/1.9N
Lens mount	M645 bayonet mount (applicable to all M645 lenses)
Shutter	Moving coil, electronic controlled focal-plane shutter
Shutter speed	(Manual) 4 sec. - 1/1000 sec., B (T) (Auto) 8 sec. - 1/1,000 sec. (when the AE Prism Finder FE401 is used)
Shutter release	Electromagnetic release. Selectable release lock or self-timer mode.
Mirror	Instant return, front coated mirror, with mirror lock-up capability.
Viewfinder	Interchangeable (Waist Level Finder N, Prism Finder FP401 and AE Prism Finder FE401) (Viewfinders for the M645 Super can be used)
Focusing screen	Standard: Rangefinder Spot/Microprism with Fresnel Lens, accessory screens available (Same as the M645 Super)
Field of view	94%

Film transport	Single turn winding by Film Advance Crank AC401. Variable crank start position (6 positions). Interchangeable (Power Drive Grip WG401 and Power Drive Grip N).		
Exposure counter	Progressive type: automatic reset. The counter for 120 and 220 film will be automatic.		
Multiple exposure	Activated by the Multiple Exposure Lever.		
Depth-of-field	Depth-of-field Scale provided on lens		
Self-timer	Electronic LED display Lights for 8 seconds, flashes for 2 seconds, before shutter release. Has manual override.		
Auxiliary shutter release socket	Accepts Remote Control and Electronic Cable Releases.		
Battery check	The-Battery Check Button, indicates residual battery capacity in 3 stages.		
Time exposure	Time (T) photography can be taken.		
Synchronization	X terminal plus hot shoe, Flash synchronization at 1/60 sec. or slower speeds		
Back cover	Dark Slide Storage. Memo Clip		
Power supply	6V battery x 1 (4SR44 silver-oxide battery, 4LR44 alkaline-manganese battery or 2CR1/3 lithium battery)		
Others	With Neck Strap.		
Dimensions & Weight			
Body with 120 Roll Film Holder HA401	124mm (W) x102.5mm (H) x 124mm (D)		980g
With Waist Level Finder N, 80mm f2.8N	124mm (W) x106 mm (H) x 158mm (D)		1,345g
With Prism Finder FP401, 80mm f/2.8N	124mm (W) x128 mm (H) x 170mm (D)		1,530g
With AE Prism Finder FE401, 80mm f/2.8N	124mm (W) x135 mm (H) x 170mm (D)		1,545g
With Power Drive Grip WG401, AE Prism Finder FE401, 80mm f/2.8N	172mm (W) x135 mm (H) x 170mm (D)		1,800g (Without Battery)

* If the camera should fail to function properly, please check the following:

1. The Shutter Release Button does not move.

Push the Battery Check Button.

If the lamp does not light, check:

Is a Battery in the camera?

If yes, is it correctly inserted? (Polarity)

Is it dead?

If the lamp does light, check:

Has the Film Holder Dark Slide been pulled?

Is the Shutter Release Selector in the locked (Red Dot) position?

If so, move it to the White Square and try again

Is the Shutter Speed Dial in the "A" or "AEL" position?

If so, turn to other setting and try again.

2. The finder is black or very dark.

Has the Lens Cap been removed?

Is the Mirror-up Lever in the "M.UP" position?

If so, turn the lever to the White Square.

Is the "AM" setting on the lens at "M" (Depth of Field Preview)?

If so, move it to "A".

3. The Roll Film Holder cannot be removed from the camera body.

Insert the Dark Slide.

4. The developed film has fewer exposures than specified.

Most likely the Start Mark had not been aligned properly when the film was loaded. (See loading instructions page 20)

5. The Film Advance Crank continues to turn and does not stop.

Was the Roll Film Insert placed in the Roll Film Holder?

Was the empty film spool left in the upper compartment?

* **Cold Temperature Photography**

- a. Use a fresh lithium battery
- b. Utilize the External Battery Case accessory. (Permits battery to be placed inside clothing).
Batteries that fail at low temperatures may still be used at normal temperatures. However frequent temperature changes shortens battery life.
- c. Avoid sudden temperature changes when going indoors, to prevent moisture condensation on camera and lenses. (Also important for film protection).

Things to Watch

- * **When using the AE Prism Finder FE401**
When using this finder it is imperative that the Film Speed Dial on the Roll Film Holder is properly set for the ISO number of the loaded film, as it interfaces with this finder. If not done, wrong exposures may result.
- * **When the mirror is locked in the up position.**
- * **The Focal Plane Shutter Curtain may be damaged if the camera faces strong light sources, especially the sun. Return mirror to normal position or cap lens to prevent such damage.**

The AE Prism Finder FE401

The Mamiya AE (Automatic Exposure) Prism Finder FE401 pentaprism guarantees a true, upright image and features built-in electronic shutter control which, ensures aperture-priority, TTL automatic exposure metering while in the A or AEL mode.

<3Way Metering System>

The FE401 comes with three metering modes: average metering (AV), spot metering (SP), and AV-SP metering capable of automatically selecting AV or SP according to subject conditions.

The LED display in the viewfinder indicates correct exposure

If you forget to extract the Dark Slide when the finder is being used with the 645 PRO, an LED will flash a warning.

The Power Drive Grip WG401

The Power Drive Grip WG401 is integral with the winder and hand grip, enabling quick and continuous exposures to be taken: frames can be advanced (about 2 frames/sec.).

Usable with any of three recently developed leaf shutter lenses, it can be connected with the lens and winder with the Grip Connector PL401, thus automatically interlocking it with the lens.

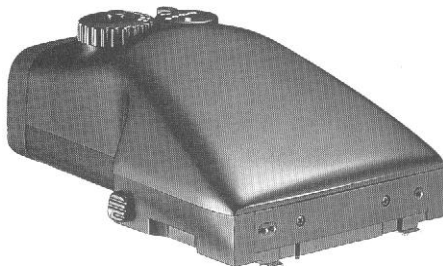

Roll Film Holders

120 Roll Film Holder HA401

220 Roll Film Holder HB401

135 Roll Film Holder HC401

(with Panoramic Adapter)

Polaroid Land Pack Film Holder HP401

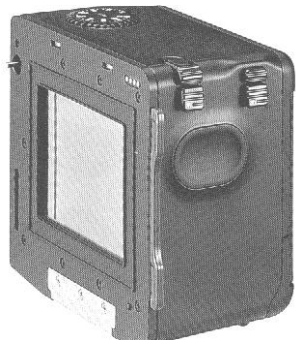

Interchangeable Lenses

Wide-angle Lenses : 35mm f/3.5N, 45mm f/2.8N,
55mm f/2.8N

Telephoto Lenses : 150mm f/3.5N, A150mm f/2.8,
210mm f/4N
ULD300mm f/5.6N, A300mm
f/2.8AP0, 500mm f/5.6

Standard Lenses : 80mm f/1.9N, 80mm f/2.8N,
110mm W2.8N

Zoom Lenses : Zoom 55 - 110mm f/4.5N,
Zoom ULD105 - 210mm f/4.5

Special Effect Lenses: Fish-eye ULD24mm f/4, Shift
50mm f/4, Macro 80mm f/4N
Soft 145mm f/4

Leaf Shutter Lenses : A55mm f/2.8N/L, A80mm
f/2.8N/L, A150mm f/3.8N/L

TeleConverter : 2 x Tele-Converter

System Chart

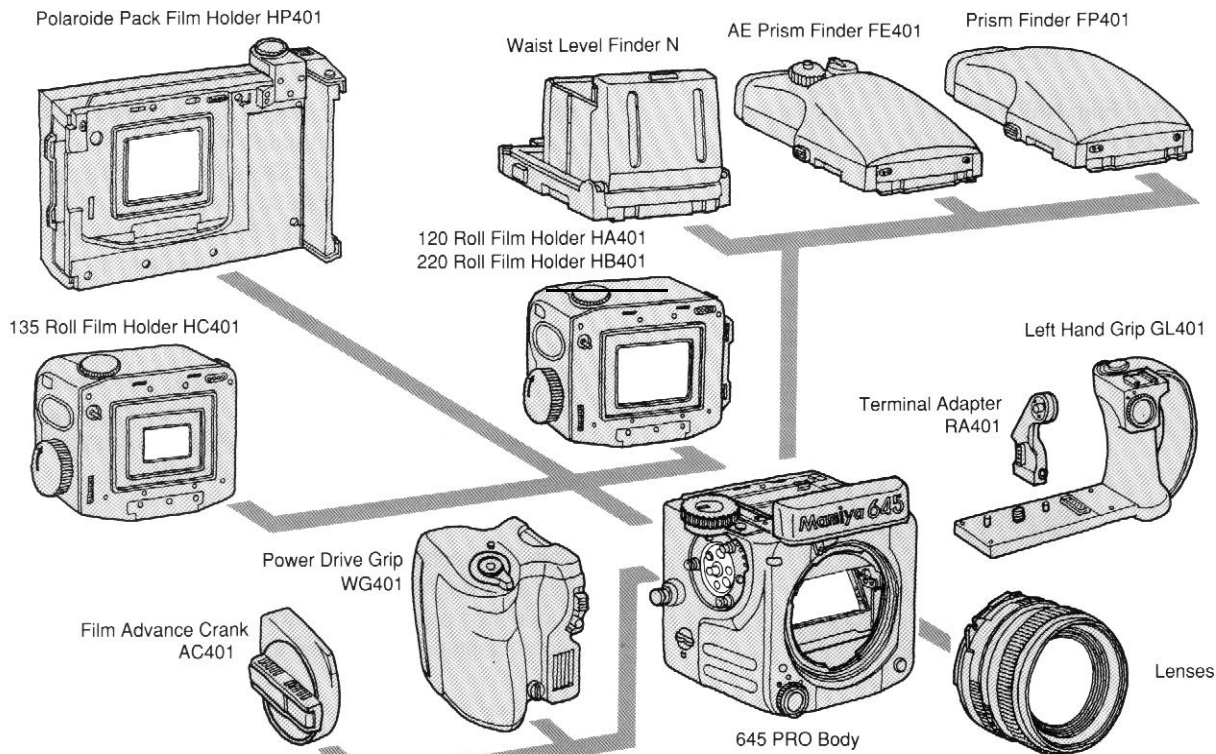

The actual products may be different from this illustration

Storing and Checking the Camera

When the camera is not used for a long period of time, remove the battery and any film from the camera.

Avoid storing the camera for prolonged periods of time in a damp or salty atmosphere. (Color film should be stored at the manufacturer's recommended temperatures.)

Since cameras are precision instruments, avoid shocks and rough handling.

When camera and lens are stored for a long time, periodically exercise the shutter(s) at various speeds and also turn the lens diaphragms.

Cleaning

Never touch the surface coated mirror. Clean dust particles with a blower and optical surfaces with lens cleaning tissue and lens cleaner.

Periodic Check

Periodically check the camera to make sure that it is in good working order, especially before an important assignment. Check the battery, flash synchronization, mirror and shutter movement, film advance, diaphragm operation, etc.

Should any malfunction occur or if the camera has been dropped, jarred or become wet, do not attempt to fix it yourself but send it to the Service Department of your Mamiya distributor.

Free Manuals Download Website

<http://myh66.com>

<http://usermanuals.us>

<http://www.somanuals.com>

<http://www.4manuals.cc>

<http://www.manual-lib.com>

<http://www.404manual.com>

<http://www.luxmanual.com>

<http://aubethermostatmanual.com>

Golf course search by state

<http://golfingnear.com>

Email search by domain

<http://emailbydomain.com>

Auto manuals search

<http://auto.somanuals.com>

TV manuals search

<http://tv.somanuals.com>