

CSA-151 SERIES ICE DISPENSERS INSTALLATION/OWNER'S/SERVICE MANUAL



MANITOWOC EQUIPMENT WORKS

Division of The Manitowoc Company, Inc.

2110 South 26th Street, P.O. Box 1720, Manitowoc, WI 54221-1720 • Phone: 414-682-0161
©MANITOWOC 1990

80-0824-3
June, 1990

FREIGHT DAMAGE AND LOSS INFORMATION

A. SHORTAGES

1. Check that the number of cartons delivered matches the quantity shown on your receipt.
2. If the quantities do not tally, have the driver note the shortage and file your claim accordingly.

B. NO-FAULT FREIGHT CLAIM PROGRAM

Manitowoc assumes responsibility for all freight damage claims involving participating carriers, except when:

1. The trucking company loses the equipment.
2. Fire destroys the equipment en route.
3. A traffic accident damages the shipment en route.

C. VISIBLE DAMAGE

1. Open all damaged cartons and inspect their contents.
2. To remove the carton, cut the banding and slide the carton up and off the unit.
3. Note the location and extent of the damage.
4. Notify your distributor to inspect the merchandise within 15 days of delivery.

D. CONCEALED DAMAGE

1. If damage is noticed after the equipment is unpacked, notify the distributor immediately and ask for an inspection.
2. Save the packing materials until inspection is complete.
3. Unless these conditions are met, your claim will probably be rejected by the distributor.

E. CLAIMS

Satisfaction is between Manitowoc and its distributor to:

1. Arrange to have repairs made, or
2. Replace the merchandise.

MODEL NUMBER DESCRIPTION

C*+150#-

C = Countertop Dispenser

* = Denotes the style of dispense actuator

T — For self-serve or two-hand operation (see Fig. 1B)

S — For glass actuated one-hand operation (see Fig.

1A)

+ = Model vintage starting with letter A

To change with any major design changes

150 and 151 = Model number with cold plate and up to eight post-mix valves

= Model variations — Customer options starts with B

- = Cabinet finish

S — Stainless Steel

F — Fawn

This dispenser has a dual purpose actuating lever.

Fig. 1A One-hand Operation



Fig. 1B

Two-hand Operation

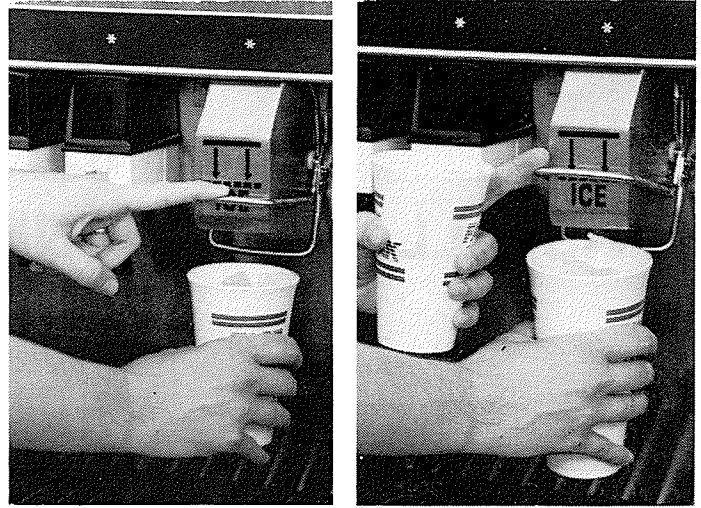

For the easiest two-hand operation, remove the one-hand lever. This is accomplished by removing the four screws which secure the one-hand actuating lever to the two-hand actuating lever.

DISPENSER INSTALLATION

We strongly recommend that the installation and "start and inspect procedure" be performed by a trained and competent technician.

GENERAL

This countertop dispenser dispenses either Manitowoc "dice" or "half dice" ice cubes.

This dispenser may be manually filled with ice or accept a top-mounted single Manitowoc Series 200, 400, or 600 model ice machine for automatic fill capability

There is an 11" clearance height between the discharge chute and grill. The clearance height is 11½" under the drink dispensing valves.

This dispenser is equipped with up to eight N.S.F. approved, or listed, post-mix drink dispensing valves (see Fig. 6).

LOCATION

This dispenser is not designed for outdoor installations or installations where temperatures drop below +40°F or rise above +110°F. For best performance, select a location away from radiators, ovens, refrigeration condensers, direct sunlight, and other sources of heat. Allow a minimum of five inches clearance around the dispenser for air circulation.

The dispenser must be located on a flat and level countertop of sufficient strength to support the dispenser with ice (400 lbs.) and the Manitowoc ice machines (200 lbs.). The dispenser should be sealed to the counter to comply with health codes (dispenser set on counter and a minimum of 1/8" radius fillet formed between countertop and dispenser base with N.S.F. approved silicone sealer). The dispenser is equipped to accept legs (sold separately), but the counter must be able to support the weight concentrated on the legs. Manitowoc recommends that the 5/8" diameter x 11-thread-per-inch weld nuts located at the corners of the dispenser base be used to bolt the dispenser to the countertop to insure stability. Whenever an ice machine is mounted on the dispenser, the dispenser must be bolted to the counter.

WATER AND DRAIN REQUIREMENTS AND CONNECTIONS

This dispenser is equipped with a 1/2" pipe female fitting at the rear for drain connection.

Drain connections must not allow waste water to back up into the storage bin. The drain lines must be vented to atmosphere and should run separately from the dispenser and ice machine (when used) to an open trapped, or vented, floor drain. Drain lines must have 1½" drop per five feet of run.

The plumbing for the drain connection can be routed out of the bottom of the dispenser. The syrup lines and the carbonated water lines and power cord can also be routed out the bottom left hand rear corner of the dispenser.

Syrup lines and carbonated water lines are marked and extend through the rear of the cabinet. These lines are capped, and connection from the syrup tanks and carbonated tank can be made to these using a barbed connector and oteiker clamps.

NOTE: All connections should be checked for leaks.

There is a separate section on the soda valve operation and adjustment (see page 9).

All plumbing must meet national and local code specifications.

ELECTRICAL REQUIREMENTS AND CONNECTIONS

This dispenser is 115-volt, 60-cycle, 1-phase, cord-connected.

The dispenser must be plugged into a 15 amp electrical outlet.

CAUTION: This dispenser must never be plugged into an extension cord. If an outlet is not within reach of the dispenser's power cord, have an electrician install a 15-amp outlet.

ICE MACHINE INSTALLATION (Automatic Fill)

1. See Ice Machine Use and Care Manual for ice machine installation.
2. The dispenser's plastic top cover is purchased separately if the dispenser is to be manually filled. It is not needed when an ice machine is top-mounted to the dispenser.
3. Inside the shipping envelope you will find two flat mounting plates to secure the ice machine to the dispenser. Fasten the plates to the lower mounting screw on the ice machine back panel. Then, using the plate as a locator, drill two holes (5/32" diameter) into the dispenser back panel and fasten the plates to the dispenser using the screws provided in the envelope (see Fig. 3).
4. If local codes require this dispenser to be permanently wired:
 - A. Disconnect power supply cord from electrical service before working on dispenser.
 - B. Remove rear access panel.
 - C. To remove original power cord from dispenser, knock out strain relief from inside out (may use pliers to squeeze together).
 - D. Proceed to front of dispenser.
 - E. Remove drain pan from the dispenser to gain access to control box and remove control box cover.
 - F. Disconnect wire nuts from power supply cord.
 - G. Remove strain relief from control box holding power cord.
 - H. From back of dispenser, pull power cord out.
 - I. Route conduit (flexible) through conduit fitting hole at lower right-hand rear corner.
 - J. Pull conduit back through access panel to install 7/8" conduit fitting.
 - K. Feed conduit to front of dispenser to control box.

L. Connect conduit fitting to control box.

M. Pull three 14 gauge conductors (black, white, and green) through conduit and connect to pigtails with wire nuts furnished. (Do not disconnect plastic strain relief holding pigtails.)

NOTE: Tape over the wire nuts with electrical tape after nuts are tightened.

Fig. 2

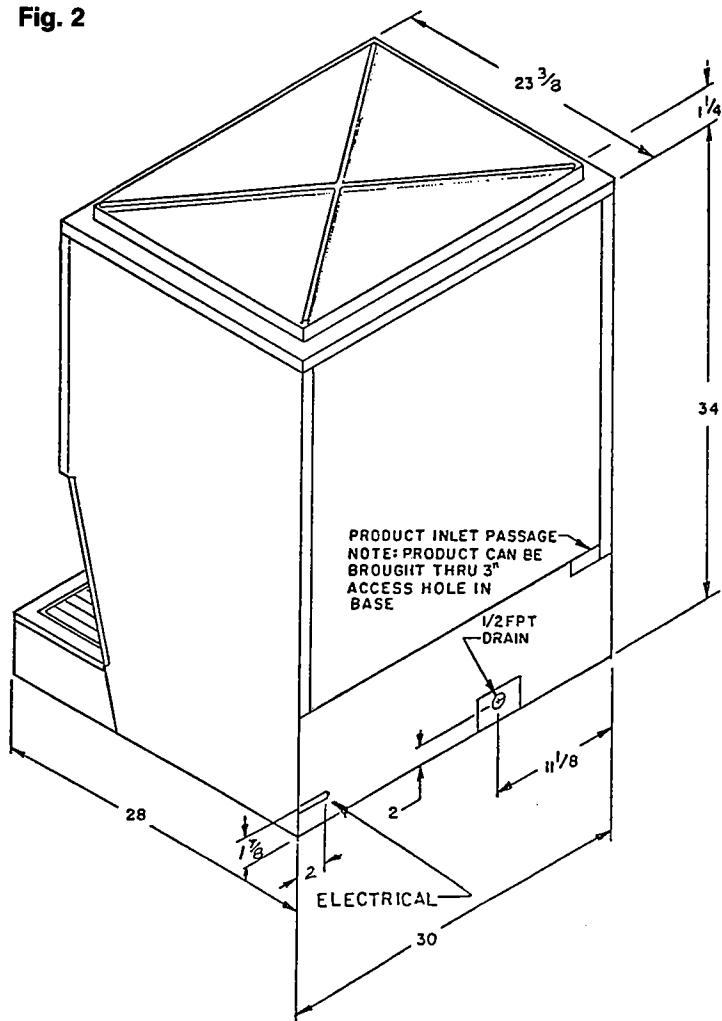
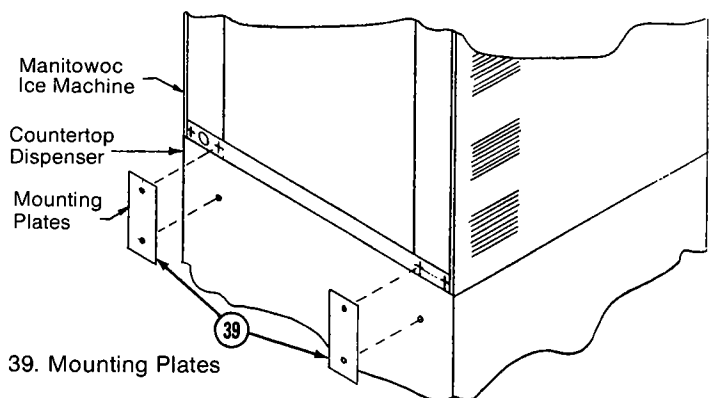
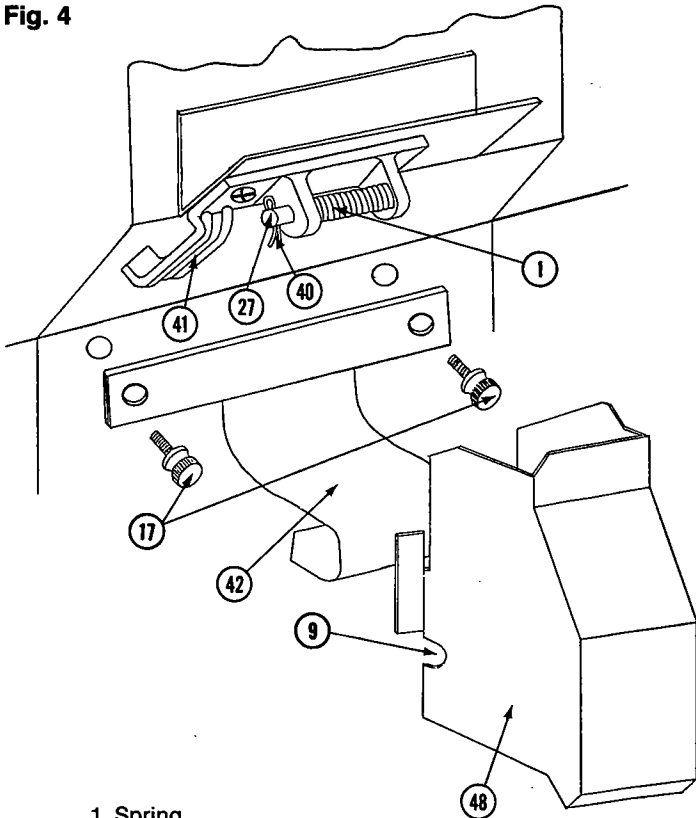

Fig. 3



Fasten mounting plate top hole using two screws from back of ice machine. Using plate as a locator, drill two holes 5/32" diameter in the back of dispenser back panel. Avoid drilling more than 1/2" deep to prevent damaging liner. Secure bottom hole in plate with screw provided.

Fig. 4



- 1. Spring
- 9. Bearing $\frac{5}{8}$ " OD x $\frac{5}{16}$ " thick
- 17. Thumbscrew — $\frac{3}{32}$ " x $\frac{7}{16}$ "
- 27. Hinge Pin
- 40. Clip — Spring Hinge Pin
- 41. Polypropylene (Living Hinge)
- 42. Insert
- 48. Ice Chute

FINAL CHECK LIST FOR DISPENSER INSTALLATION

1. Is the dispenser level?
2. Has all internal packing, auger shipping block, and tape been removed?
3. Are all electrical and water connections complete?
4. Is there a 5" clearance on all sides for air circulation? (Required when an ice machine is placed on top.)
5. Is there a separate drain for the dispenser, when an ice machine is placed on top?
6. Are the drains vented?
7. Has the ice machine (when used) been secured to the dispenser?
8. Is the lower back panel assembly (Item 69, Fig. 13) on the dispenser? This should be in place before the dispenser is operated.
9. When the actuator is depressed, is the dispenser operational.
10. Has the dispenser been sealed and fastened to the countertop?
11. Have the carbonated water and syrup lines been checked for leaks?

NOTE: When installing a Manitowoc ice machine on top of this dispenser, it is important to correctly set the ice machine's ice bridge thickness. The thinner the ice bridge on the ice machine, the better the ice will break up for dispensing. Too thick a bridge will allow ice chunks to fall into the bin and prevent cubes from breaking up for easy dispensing. This will cause a slower dispensing rate.

If using a small-mouthed glass, $2\frac{1}{2}$ " diameter, or smaller, it is recommended that "dice" size cubes be used.

SERIAL NUMBER AND ELECTRICAL DATA

An identification plate detailing serial number and electrical data is located on the dispenser's front cover.

OPERATION PRINCIPLES (Countertop)

This dispenser's electric motor is coupled directly to a right angle gear box that drives through a $\frac{3}{8}$ " pitch positive displacement belt, the dispensing auger, and an agitator auger.

The dispensing auger turns at approximately 35 revolutions per minute, and the agitator turns at approximately 17 revolutions per minute (see Fig. 5).

The dispenser motor is activated by an ice delivery switch located in a switch control box enclosure behind the upper front panel of the dispenser. The ice delivery switch is closed by the ice delivery actuator lever, which is activated by the customer, or attendant, when ice is required (see Fig. 6A). This switch controls a solid state relay that controls power to the dispenser motor (see Fig. 9).

The ice deliver rate ranges from 1.8 oz./sec. to 0.8 oz./sec., depending on cube size and bin fullness.

NOTE: Always be sure electrical power is disconnected before cleaning or performing maintenance on this dispenser.

Fig. 5

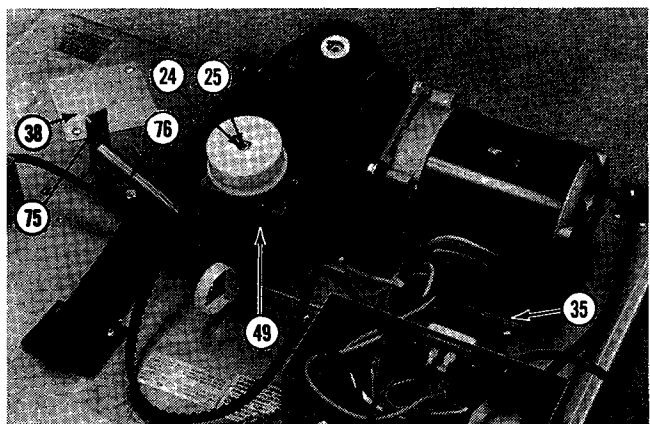

- 24. Washer $1\frac{1}{8}$ " OD
- 25. Tensioner Bearing
- 35. Gear Motor Lock Bracket
- 38. Cover — Base Hole
- 49. Belt Tensioner Mtg. Bracket Weld
- 75. Bracket Spring Belt Tightener
- 76. Spring Belt Tensioner

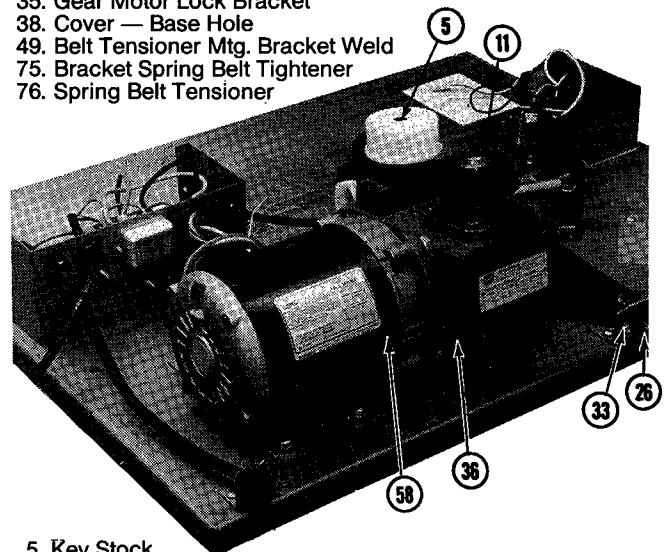

- 5. Key Stock
- 11. Small Drive Pulley Assembly
- 26. Drain Fitting Assembly
- 33. Drain Fitting Bracket
- 36. Gear Box Angle Bracket Tie Strap
- 58. Drive Motor/Gear Reducer

CLEANING INSTRUCTIONS

1. Remove all ice from dispenser.
2. Disconnect the dispenser's electrical power.
3. Remove top cover on manually filled dispensers, or ice machine front panel, if an ice machine is assembled on top of dispenser.
4. Remove upper front panel's two screws.
5. Remove three thumbscrews holding the auger upper bearing bracket in place and remove the auger upper bearing bracket, along with the auger.
6. Remove the ice chute and actuator lever assembly by removing thumbscrews (see Fig. 6A). The assembly must be slid down while holding the ice outlet door open.
7. Remove the lower front panel's four screws and lay forward in drain area (see Fig. 6B).
8. Remove the ice outlet door, switch box, and mounting bracket (see Fig. 6C) by lifting up and forward. This assembly can be laid on top- of the lower front panel removed in Step 6.
9. Remove auger access panel by removing four thumbscrews (see Fig. 6E).
10. Remove lower agitator coupling and agitator flight extension (see Fig. 6D).
11. The dispenser liner and cold plate can now be cleaned and sanitized with a solution of 3 oz. of Manitowoc Ice Machine Cleaner per gallon of water (see Fig. 6D).
12. The agitator flights, upper bearing, shaft, and upper bearing bracket assemblies can be cleaned and sanitized with same solution (see Fig. 6E).
13. The dispensing auger can be disassembled by removing the stainless steel pin at the top of the auger. Remove the pin, and the auger flights will slide off the shaft for cleaning (see Fig. 6E).
14. Rinse all parts with clean water before assembling.

WARNING: Do not use metal scrapers or abrasives on the bin liner or plastic parts. These will destroy the smooth surfaces.

Fig. 6

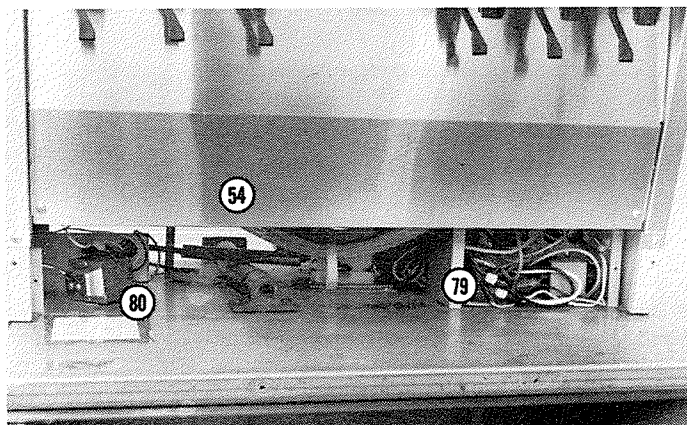

54. Lower Front Panel
79. Control Box
80. Transformer Box

Fig. 6A



37. Electrical Box Switch
55. Switch/Actuator Pilot Duty

Fig. 6B

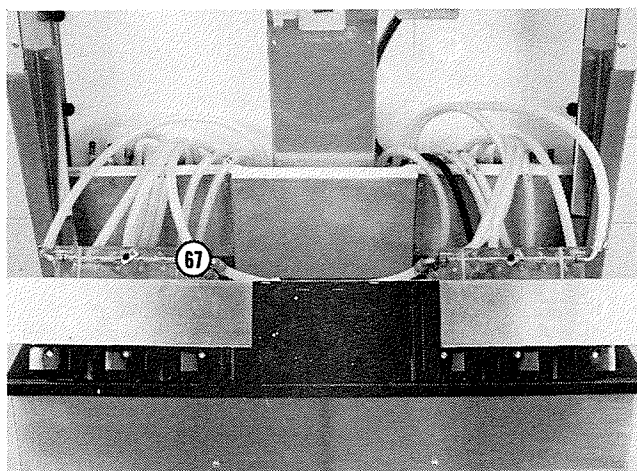

67. Soda Manifold

Fig. 6C

37. Electrical Box Switch
41. Door — Living Hinge
46. Bracket Ice Outlet Door Mounting

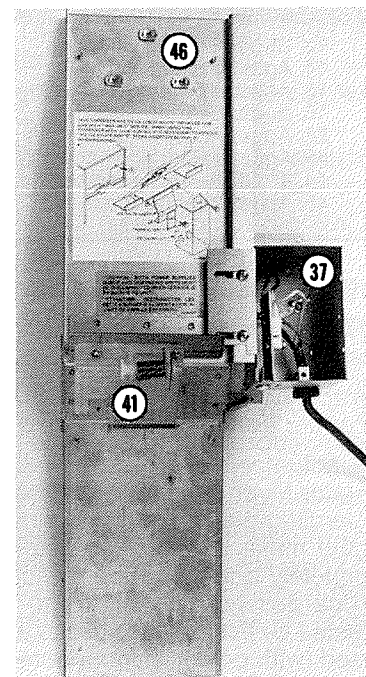
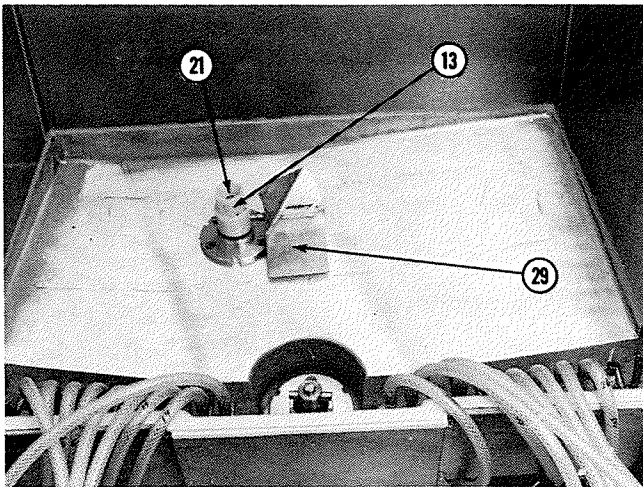
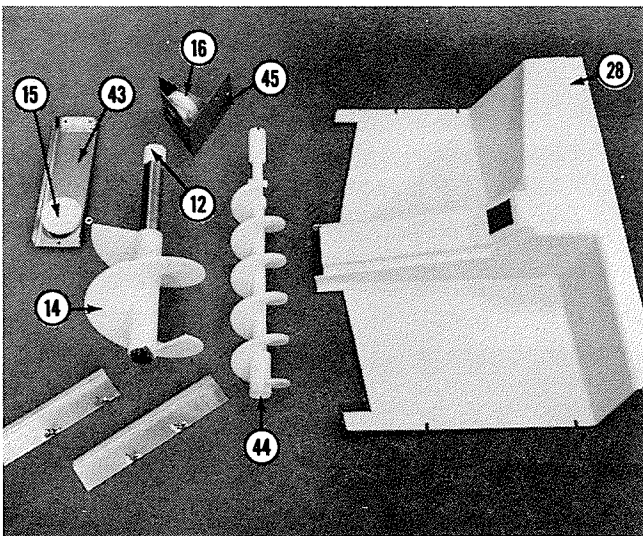

Fig. 6D



- 13. Agitator Drive Coupling
- 21. 1/4-20 x 1
- 29. Weldment Agitator Shaft Paddle

Fig. 6E



- 12. Upper Bearing Coupling
- 14. Agitator Flight 8" OD
- 15. Agitator Bearing 1.625 ID
- 16. Auger Bearing 1.334 ID
- 28. Auger Access Panel
- 43. Agitator Bearing Bracket Weld
- 44. 4" OD Auger Assembly
- 45. Auger Bearing Bracket

SWITCH ADJUSTMENTS AND REPLACEMENT

NOTE: Before removing the switch control box cover, disconnect electrical power to the dispenser.

The actuator switch is located in a switch control box behind the upper front panel (see Fig. 6 and 6A).

The actuator switch is normally open but closes as the actuator lever is pushed back or down. It can be adjusted by bending the flat, or round, arm on the switch. The switch should make contact just before the ice delivery door is completely open, and the switch contacts should open as the ice delivery door starts to close. The switch can be adjusted by listening for clicks as the switch is opened and closed (with power disconnected).

AUGER AND AGITATOR DRIVE ASSEMBLY REMOVAL

1. Remove all ice from dispenser.
2. Disconnect the dispenser's electrical power.
3. Remove top cover on manually filled dispensers, or ice machine front panel, if an ice machine is assembled on top of dispenser.
4. Remove upper front panel's two screws.
5. Remove three thumbscrews holding the auger upper bearing bracket in place and remove the auger upper bearing bracket, along with the auger.
6. Remove the ice chute and actuator lever assembly by removing thumbscrews (see Fig. 6A). The assembly must be slid down while holding the ice outlet door open.
7. Remove the lower front panel's four screws and lay forward in drain area (see Fig. 6B).
8. Remove the ice outlet door, switch box, and mounting bracket (see Fig. 6C) by lifting up and forward. This assembly can be laid on top of the lower front panel removed in Step 6.
9. Remove auger access panel by removing four thumbscrews (see Fig. 6E).
10. Remove lower agitator coupling and agitator flight extension (see Fig. 6D).
11. The drive assembly is now accessible for bearing removal (see Bearing Removal).

BELT TIGHTENING AND REPLACEMENT

NOTE: Before tightening or replacing the belt, disconnect the electrical power to the dispenser.

The belt is held snug by a tensioner that is located between the gear motor pulley and ice dispensing auger pulley. This is accessible by removing the dispenser's rear panel. Access is also available from the dispenser front by removing the drain pan wrapper, drain pan, and front panels. Working from the front is more difficult.

The belt is tensioned by an extension spring (see Fig 8). Any time a belt is replaced or the tensioner is loosened, grease should be reapplied between the tension wheel bracket and the cabinet base. This grease will insure that the tensioner bracket can move freely. Be sure wedge is correctly positioned under the gear box (see Fig. 8).

Fig. 7

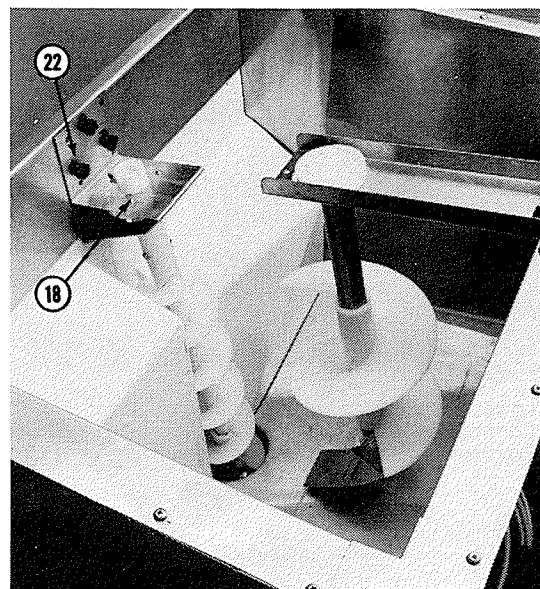

- 18. Thumbscrew #8 x 1/2 Type A
- 22. Thumbscrew — Plastic

SERVICE

NOTE: All service should be performed by a Manitowoc Service Representative.

TROUBLESHOOTING

| TROUBLE | POSSIBLE CAUSE | CORRECTIVE MEASURES |
|-----------------------------------------|-------------------------------------------------------------------|----------------------------------------------------------------------------------------------------------------|
| Dispenser will not dispense ice. | Bin empty. | Fill manually or check ice machine operation. |
| | Large clusters of ice in bin. | Check and adjust ice bridging. Do not use bagged ice, or be sure ice is broken up before putting in dispenser. |
| | Ice jammed in ice chute opening. | Check and clear opening. |
| | Defective switch. | Check and adjust or replace. |
| | Drive belt broken or loose. | Tighten or replace. |
| Drive motor operates, but doesn't turn. | Drive motor defective. | Check or replace motor. Check start capacitor or replace. Check electronic motor starting switch or replace. |
| | Auger not properly seated on lower bearing drive shaft. | Check and reseal correctly. |
| | Keys not in place on shafts. | Replace Key. |
| | Belt loose. (If belt is loose, you will hear a ratcheting noise.) | Grease base under tensioner bracket. Verify wedge is located under gear box. |
| Motor running continuously. | Defective gear | Check and replace reducer. |
| | Ice jammed in door opening. | Clear door. This can usually be done by dispensing a glass of ice. |
| | Switch. | Adjust or replace. |

Fig. 8

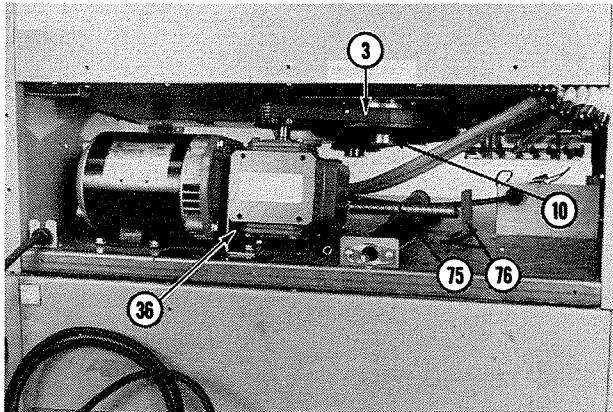

- 3. Positive Drive Belt
- 10. Large Pulley Assembly
- 36. Gear Box Angle Bracket
- 75. Spring — Belt Tightener
- 76. Bracket — Spring Belt Tightener

BEARING ASSEMBLY REMOVAL

1. See Auger and Agitation Drive Assembly Removal to gain access to lower bearing and drive shaft assemblies.
2. Loosen belt by loosening the belt tensioner and remove the belt (refer to Belt Tightening and Replacement).
3. Remove lower bearing drive pin and the plastic drive coupling on the agitator drive shaft (see Fig. 10).
4. Remove three bolts that hold the upper bearing housing assembly to the lower bearing housing assembly. **Note:** Bolt heads are #7 Torx head and have been filled with silastic that should be cleaned out to insure good wrench engagement.
5. Withdraw the three bolts from inside the bin and lift upper bearing assembly out of dispenser.
6. Withdraw the lower bearing assembly from the gear-and-motor compartment side.

BEARING ASSEMBLY INSTALLATION

1. Install upper drive shaft housing assembly gasket to insure a water-tight seal between upper bearing housing and cold plate. Then position bearing assembly in bottom of bin.
2. From inside the bin, insert the three mounting bolts through the upper bearing housing. Use food grade silastic under the bolt heads to insure no water leakage.
3. Install the lower bearing housing and shaft from the gear-and-motor drive compartment side.
NOTE: Start all three bolts and tighten together to assure alignment. Tighten to 95 ± 5 in.-lbs. of torque.
4. Insert the pin into the lower bearing drive shaft and insert the bolt and washer. The plastic drive coupling must be replaced on the agitator drive shaft.
5. Install the auger and agitator assemblies (refer to Auger Assembly).

TROUBLESHOOTING ELECTRONIC START WINDING SWITCH

Item 57 (Sinpac Switch), Fig. 12 (see Wiring Diagram, Fig. 9)

This device switches the start winding in and out of the circuit.

This device replaces the mechanical/centrifugal switch on the $\frac{1}{4}$ hp capacitor start motor. The electronic switch (Item 57) monitors the voltage wave forms across the start winding. The wave form displays a slight dip followed by a rise at the motor shaft speed where proper switch operation should occur (75-80% of synchronous speed).

The electronic switch will usually fail with the switch (Triac) in the open mode (nonconducting). If the motor won't start and run, the switch can be tested by momentarily jumping the device across terminal number 3 and 2. This will engage the start winding.

Fig. 9

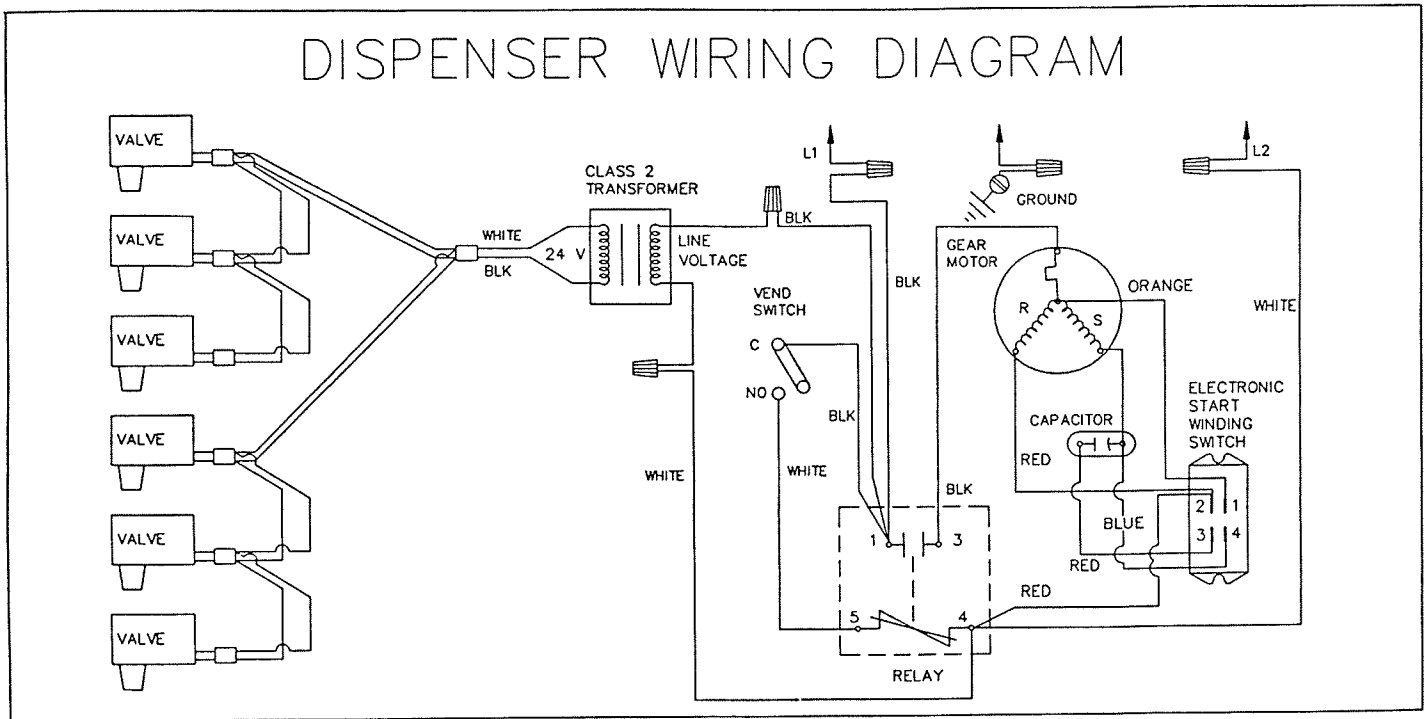

If for some reason the electronic switch failed in the closed mode (conducting), the motor overload should trip, and the device (Item 57) can be checked with an amp probe on the line coming off terminal number 2. The amp draw should decrease within one second, if start winding drops out.

NOTE: Anytime a problem occurs with the motor, the start capacitor (Item 72, Fig. 12) should be suspected and checked.

The dispenser is fitted with a Class 2 step-down transformer to provide 24 volt AC current to operate the soda valve solenoids (see Fig. 9, Wiring Diagram, and Fig. 17). This transformer is located in the dispenser bottom and is accessible by removing the drain pan (see Fig. 15).

Fig. 10

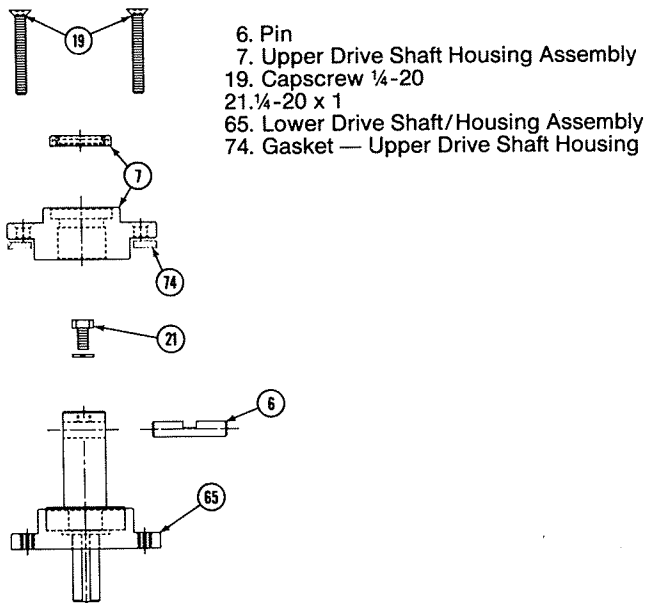

SODA OPERATION

This dispenser is equipped with post mix N.S.F. approved soda-dispensing valves and a cold plate. This cools the soda water and syrup before dispensing the product through the valves (see Fig. 14).

Fig. 11

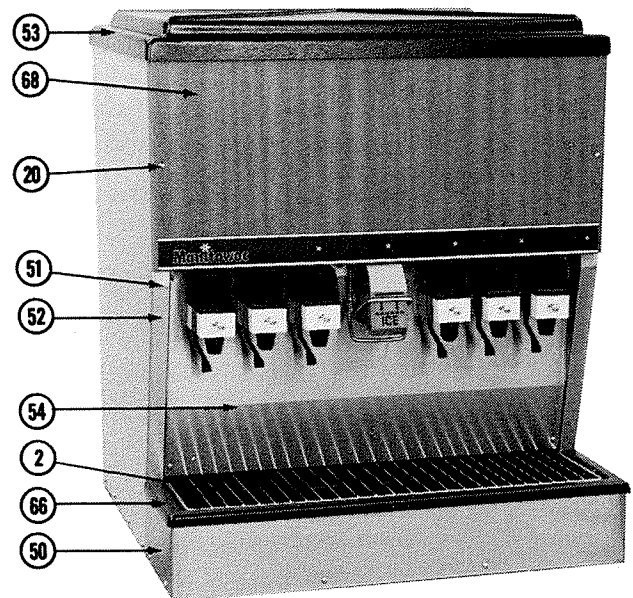

- 2. Grill — Wire
- 20. #8-32 x 1 1/4 Phil Tr MS/Zinc
- 50. Drain Pan Wrapper
- 51. LH Lower Front Trim
- 52. RH Lower Front Trim
- 53. Top Cover (Black)
- 54. Lower Front Panel
- 66. Drain Pan Assembly
- 68. Front Panel Assembly

Fig. 12

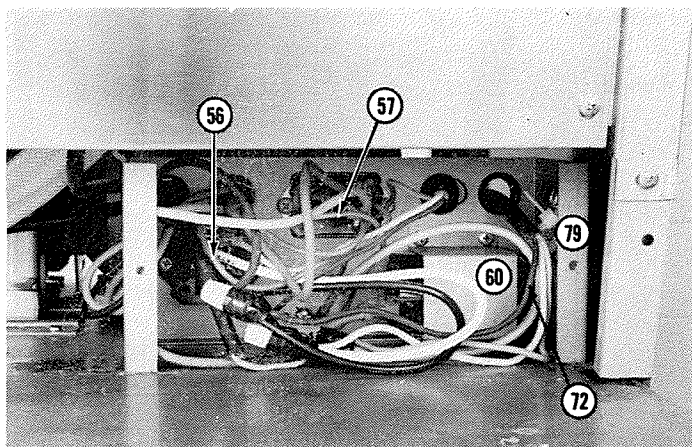

- 56. Relay — Electronic
- 57. Sinpac Switch
- 60. Start Capacitor Bracket
- 72. Start Capacitor
- 79. Control Box

Fig. 13

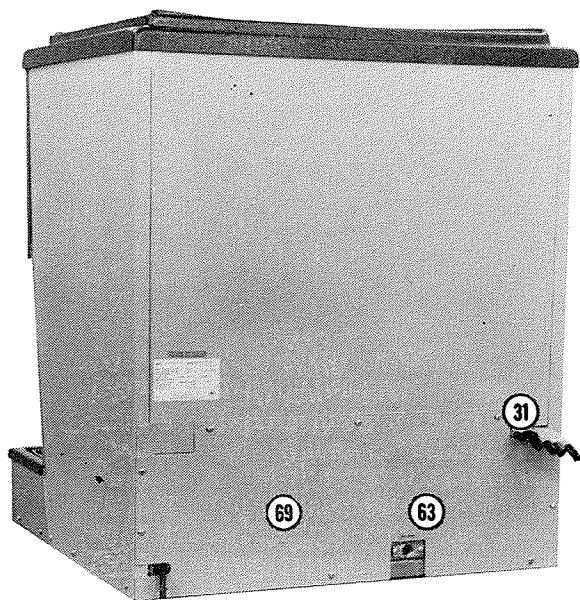

- 31. Product Inlet Lines
- 63. Drain Fitting Filler Plate
- 69. Lower Back Panel Assembly

OPERATION THEORY

A CO₂ cylinder delivers carbon dioxide (CO₂) gas through adjustable CO₂ regulators to a carbonator tank and syrup tanks. None of the above are furnished with this dispenser. Plain water is piped into the carbonator tank, and the regulated CO₂ gas is also piped into the carbonator tank. A pump is used to carbonate the water with the CO₂ gas and is then pumped to a cold plate where the water is cooled by use of the ice in the dispenser. The syrup is also routed through the cold plate to be cooled, and when a valve is opened, the syrup is forced through the valve by the regulated CO₂ pressure or by bag in box pumps. Syrup and carbonated water meet at the dispensing valve resulting in a carbonated drink being dispensed (see Fig. 19 and 19A for plumbing schematic).

CONNECTING DRINK LINES

Syrup lines and one carbonated water line have been connected to the cold plate and extended out the rear of the cabinet (see Fig. 13). All internal syrup and carbonated water lines are internally connected between the cold plate and the dispensing valves at the factory.

NOTE: Lines can be routed through the unit's base by removing cover inside rear panel.

Field connections of the syrup lines and carbonated water lines can be made to the lines extending out the rear of the dispenser by use of a straight hose connector and crimping tube clamps (O-clamps) (see Fig. 20). Check connection for leaks.

PREPARING THE SODA SYSTEM FOR OPERATION

1. Plug dispenser into power source.
2. Momentarily push each dispensing valve lever and note if electric solenoid valve on each valve is opening.
3. Adjust CO₂ regulators primary to carbonator and secondary CO₂ regulator to syrup tanks.

CO₂ regulators to syrup (sugar) tanks should be adjusted to 40 psig for syrup lines up to ten feet long and one psig for each additional ten feet in length plus one psig for every two feet in vertical rise.

On low calorie (diet) syrup tanks, the secondary CO₂ regulator should be adjusted to ten psig for up to 30 feet of line. The low calorie regulator should never be adjusted above 12 psig because this may cause excess foaming.

The primary CO₂ regulator should be adjusted at 60 to 100 psig.

NOTE: To readjust a CO₂ regulator to a lower setting, loosen the adjusting screw locknut and then turn the screw to the left (counterclockwise) until pressure gauge reads ten psig below what the new setting will be. Turn the adjusting screw to the right (clockwise) until the new setting is obtained and then tighten the locknut.

Fig. 14

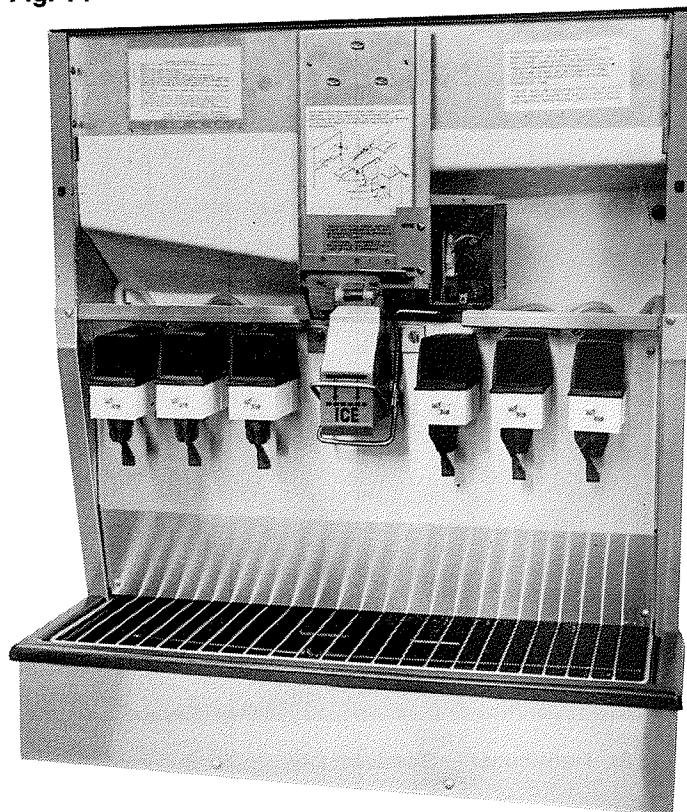
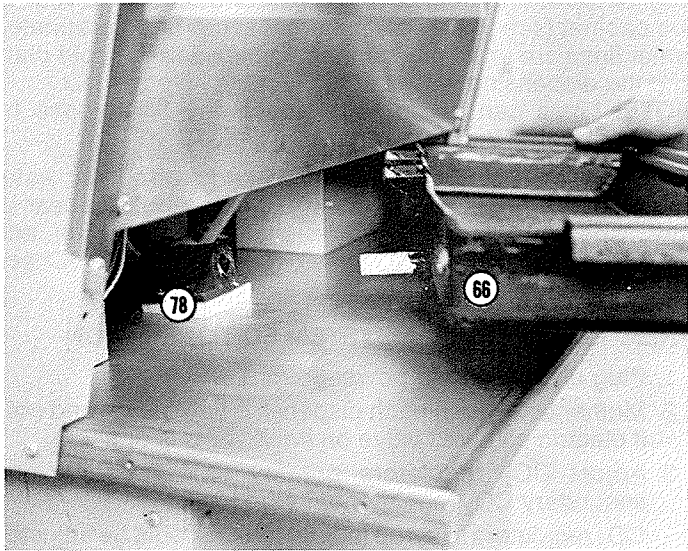
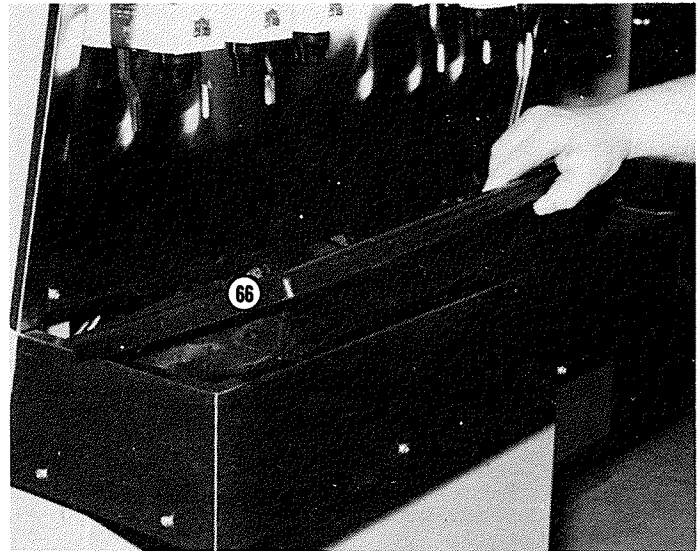

Fig. 15



66. Drain Pan Assembly
78. Drain Pan Hose Seal

Fig. 18



66. Drain Pan Assembly

Fig. 16

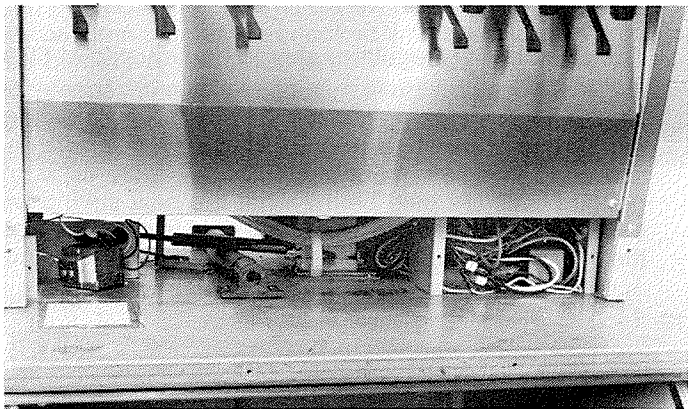
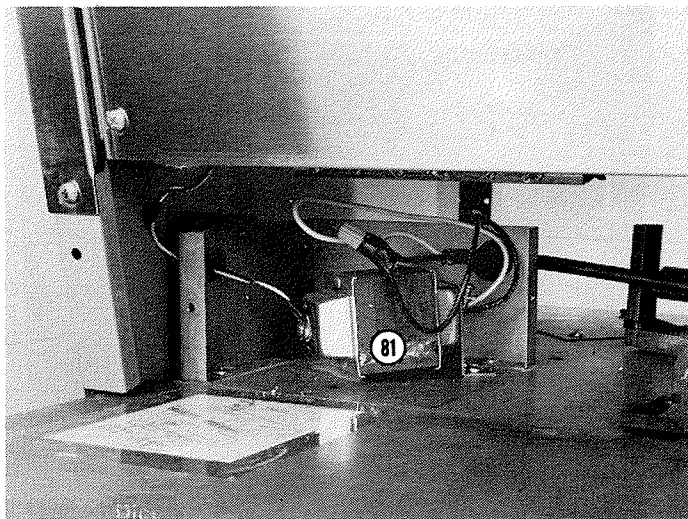
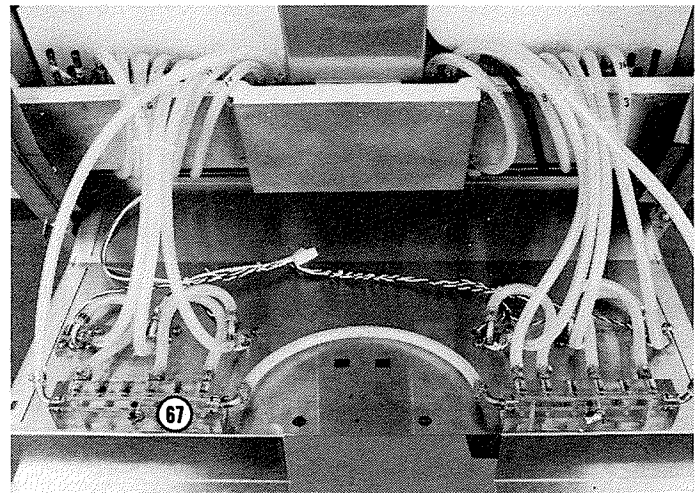

Fig. 17



81. Transformer — Stepdown 24V

Fig. 19



67. Soda Manifolds

IMPORTANT All syrup systems must be sanitized before the dispenser is put into operation.

Only qualified persons should perform sanitizing procedures.

When washing dispensing valve, care must be taken not to get water on electrical solenoids.

SANITIZING SYRUP SYSTEM AS REQUIRED BY LOCAL HEALTH CODES

1. Remove disconnect from syrup tank.
2. With a nylon brush and detergent soap solution, scrub both halves of the disconnect and rinse with clean water.
3. Using a sanitizing solution of one ounce per gallon of Chlor-Tergent (Oaklite Products Inc.), or Chlorox, mixed with water (resultant, concentration 300 PPM chlorine), sanitize both halves of the connectors and allow to air dry.

4. Connect hose half of disconnecter to a clean syrup tank filled with sanitizing solution described in Step 3.
5. Connect CO₂ syrup tank supply hose to sanitizer filled tank.
6. Place a container under the proper valve to collect waste. Open valve and permit sanitizing solution to flush syrup out of the system and valve. Allow to run until only sanitizing solution comes out.
7. Disassemble the diffusing assembly from the valve, and using a nylon brush and detergent soap solution, scrub the diffusing assembly and nozzle. Rinse with clear water.
8. Reassemble diffusing assembly and nozzle.
9. Open valve and allow sanitizing solution to be dispensed again.
10. Remove tank containing sanitizing solution from syrup system and reconnect syrup tank to system.
11. Open valve and allow to run, collecting the sanitizing solution. Continue to run valve until no sanitizing solution is collected.
12. Repeat the above procedure on all syrup lines in the system.
13. The syrup tank that was used for the sanitizing solution should be thoroughly rinsed inside and outside, each time after the sanitizing, with plain water to remove all solution residue.

NOTE: Any sanitizing solution left in the syrup system could create a health hazard, therefore, care must be taken to insure no sanitizing solution is left in the system.

NOTE: Before attempting to remove syrup tank cover, or covers, be sure the CO₂ pressure has been released from the tank. It could be dangerous to remove the cover before pressure is bled off.

NOTE: Before connecting a new CO₂ cylinder to the drink-dispensing system, be sure the CO₂ primary regulator is closed. Turn adjusting lever all the way out (counterclockwise).

CLEANING CO₂ CHECK VALVES

The CO₂ check valve should be inspected and serviced at least once a year. The syrup supplier should perform this function on this equipment.

IMPORTANT

Only qualified personnel should service soda/syrup components or electrical wiring.

WARNING

Disconnect electrical power to dispenser before attempting any electrical repairs to internal components. If repairs are to be made to CO₂, syrup, carbonated water, or plain water systems, shut off plain water and CO₂ supplies, disconnect carbonator power cord, disconnect syrup tanks, and bleed systems pressures before proceeding.

Fig. 19A

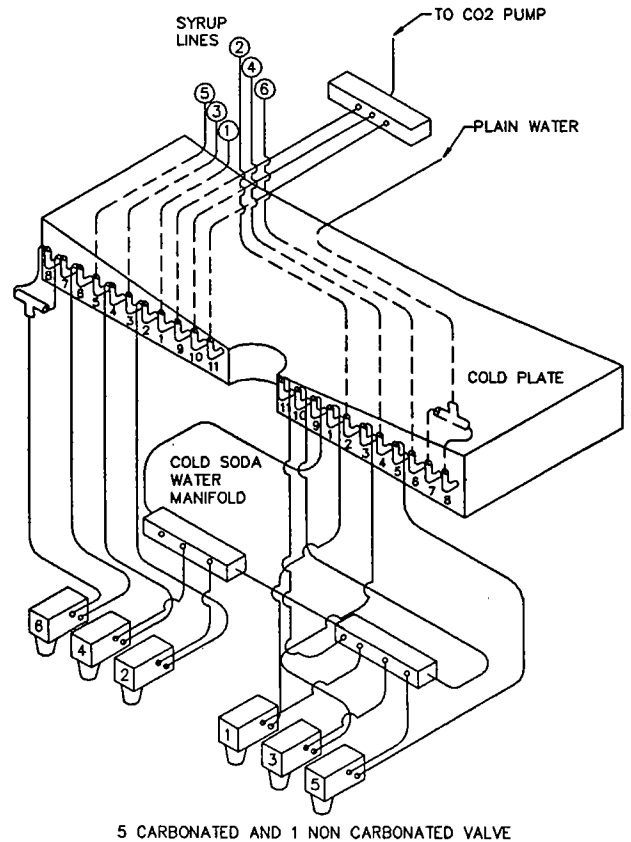
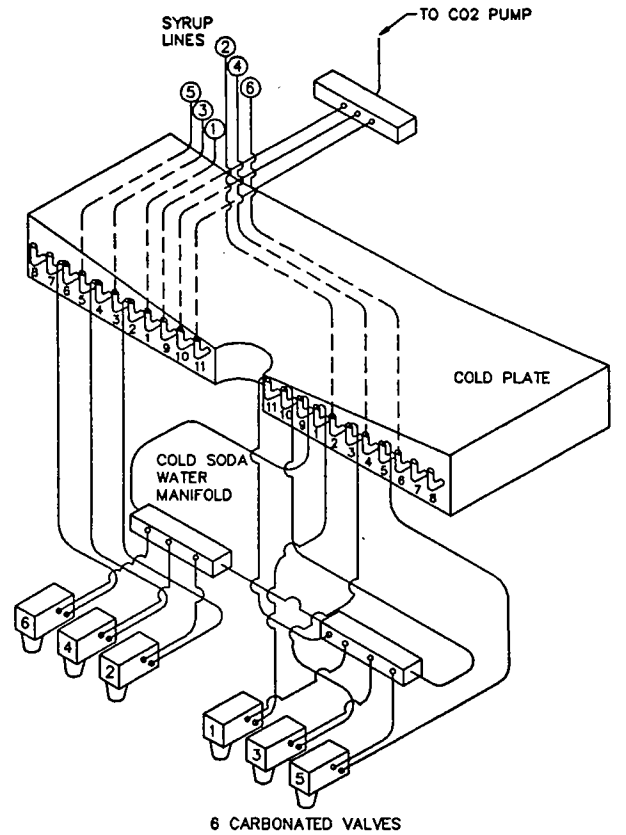
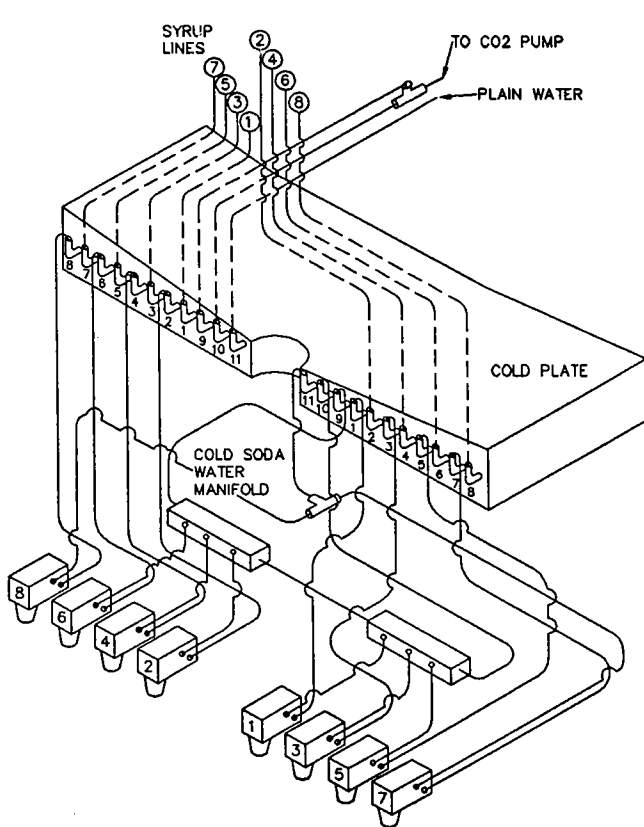
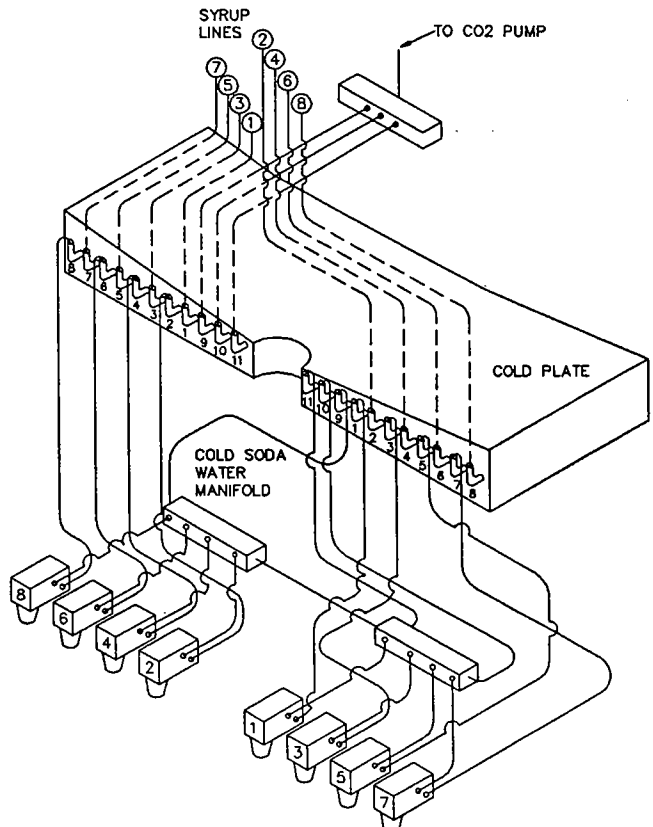

Fig. 19A continued



6 CARBONATED AND 2 NON CARBONATED VALVES



8 CARBONATED VALES

Fig. 20 Instructions For Crimping Tube Clamps

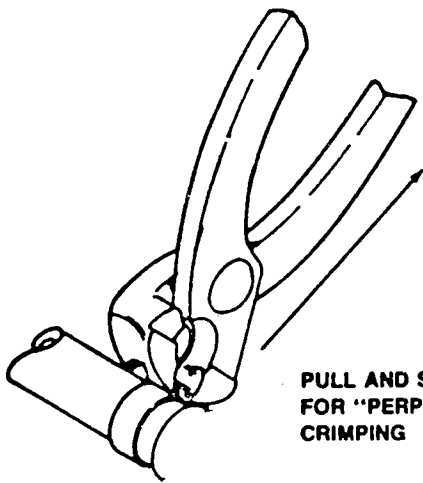

PULL AND SQUEEZE PINCER FOR "PERPENDICULAR" CRIMPING

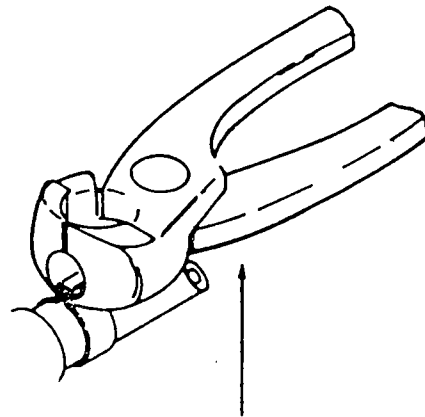

LIFT AND SQUEEZE PINCER FOR "PARALLEL" OR "SIDE SADDLE" CRIMPING

DO

SLIDE CLAMPS ON TUBING BEFORE INSTALLING TUBING ON FITTING

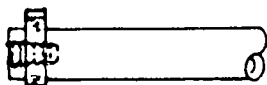

POSITION CLAMP BEHIND FIRST BARB FITTING FOR CRIMPING

DON'T

| | |
|-----------------------------------------|---------------------------------|
| <p>DO</p> <p>PROPER CRIMPING</p> | <p>IMPROPER CRIMPING</p> |
| <p>ONE-SIDED</p> | <p>TWISTED</p> |
| | <p>OVER-CRIMPED</p> |

TROUBLESHOOTING

| TROUBLE | POSSIBLE CAUSE | CORRECTIVE MEASURES |
|----------------------------------------------------------------------------------------------------------|-----------------------------------------------------------------------------------------------------------------|------------------------------------------------------------------------------------------------------------------------------------------------------------------------------------------------------------------------------------------------------------------|
| Water-to-syrup "ratio" too low or too high. | Dispensing valve syrup flow regulator not properly adjusted. | Adjust water-to-syrup "ratio" as instructed. |
| | CO ₂ gas pressure to syrup tanks insufficient to push syrup out of tank. | Adjust syrup tank's secondary CO ₂ regulator as instructed. |
| Adjustment of dispensing valve syrup flow regulator does not increase to desired water-to-syrup "ratio". | No syrup supply. | Replenish syrup supply as instructed. |
| | Syrup tank quick disconnects not secure. | Secure quick disconnects. |
| | Syrup tank's secondary CO ₂ regulator out of adjustment. | Adjust syrup tank's secondary CO ₂ regulator as instructed. |
| | Dispensing valve syrup flow regulator, syrup tank quick disconnect, or syrup line restricted. | Sanitize syrup system as instructed. |
| | Improper syrup Baume. | Replace syrup supply as instructed. |
| | Dirty or inoperative piston or spring in dispensing valve syrup flow regulator. | Disassemble and clean dispensing valve syrup flow regulator. NOTE: If necessary to disassemble and clean dispensing valve's syrup flow regulators, do not intermix their pistons and cylinders, as they are precision matched sets. |
| Adjustment of dispensing valve syrup flow regulator does not decrease to desired water-to-syrup "ratio". | Dirty or inoperative piston or spring in dispensing valve syrup flow regulator. | Disassemble and clean dispensing valve syrup flow regulator. NOTE: If necessary to disassemble and clean dispensing valve's syrup flow regulators, do not intermix their pistons and cylinders, as they are precision matched sets. |
| | | |
| Dispensed product's carbonation too low. | Carbonator primary CO ₂ regulator out of adjustment for existing water conditions or temperature. | Adjust carbonator primary CO ₂ regulator (reference manual provided with carbonator. |
| | Air in carbonator tank. | Vent air out of carbonator tank through relief valve. Actuate dispensing valve carbonated water lever to make carbonator pump cycle on. |
| | Water, oil, or dirt, in CO ₂ supply. | Remove contaminated CO ₂ . Clean CO ₂ system (lines, regulators, etc.) using a mild detergent. Install a clean CO ₂ supply |
| Dispensed product comes out of dispensing valve clear. | Oil film or soap scum in cup or glass. | Use clean cups and glasses. |
| | Ice used for finished drink is sub-cooled. | Do not use ice directly from freezer. Allow ice to become "wet" before using. |
| Dispensed product produces foam as it leaves dispensing valve. | Insufficient ice supply in ice bin. | Replenish ice supply as instructed. |
| | Carbonator CO ₂ regulator pressure too high for existing water conditions or temperature. | Reduce carbonator CO ₂ regulator pressure setting. Reference manual provided with carbonator. |
| | Syrup over-carbonated with CO ₂ , as indicated by bubbles in inlet syrup lines leading to dispenser. | Remove syrup tank's quick disconnects. Relieve tank CO ₂ pressure, shake tank vigorously, then relieve tank CO ₂ pressure as many times as necessary to remove over-carbonation. |
| | Dispensing valve restricted or dirty. | Sanitize syrup system as instructed. |
| | Dirty water supply. | Check water filter. NOTE: If water supply is dirty, be sure to flush lines and carbonator completely. It may be necessary to remove lines to carbonator tank, invert tank, and flush tank and all inlet lines to remove any foreign particles of dirt. |
| | | |

TROUBLESHOOTING (continued)

| TROUBLE | POSSIBLE CAUSE | CORRECTIVE MEASURES |
|--------------------------------------------------------------------------------------------------------------------------------------------------------------------------------------|------------------------------------------------------------------------------------------------|--------------------------------------------------------------------------------------------------|
| No product dispensed from all dispensing valves. | No electrical power to dispenser. | Plug in dispenser power cord. |
| | Disconnected or broken wiring to dispensing valve. | Connect or replace wiring. |
| | Inoperative 115/24VAC transformer. | Replace transformer. |
| No product dispensed from one dispensing valve. | Broken or disconnected wiring. | Repair or connect wiring. |
| | Inoperative dispensing valve solenoid coil. | Replace solenoid coil. |
| | Inoperative dispensing valve switch. | Replace switch. |
| Only carbonated water dispensed. | Quick disconnects not secure on syrup tanks. | Secure quick disconnects on syrup tanks. |
| | Out of syrup. | Replenish syrup supply as instructed. |
| | Syrup tank's secondary CO ₂ regulator not properly adjusted. | Adjust syrup tank's secondary CO ₂ regulator as instructed. |
| | Inoperable dispensing valve. | Repair dispensing valve. |
| | Dispensing valve syrup flow regulator not properly adjusted. | Adjust dispensing valve syrup flow regulator (water-to-syrup "ratio") as instructed. |
| | Dispensing valve syrup flow regulator, syrup tank quick disconnect, or syrup lines restricted. | Sanitize syrup system as instructed. |
| <p>NOTE: If necessary to disassemble and clean dispensing valve's syrup flow regulators, do not intermix their pistons and cylinders, as they are precision matched sets.</p> | | |
| Only syrup dispensed. | Plain water inlet supply line shut-off valve closed. | Open plain water inlet supply line shut-off valve. |
| | Carbonator power cord unplugged from electrical outlet. | Plug carbonator power cord into electrical outlet. |
| | Carbonator primary CO ₂ regulator not properly adjusted. | Adjust carbonator primary CO ₂ regulator (reference manual provided with carbonator). |

Fig. 21

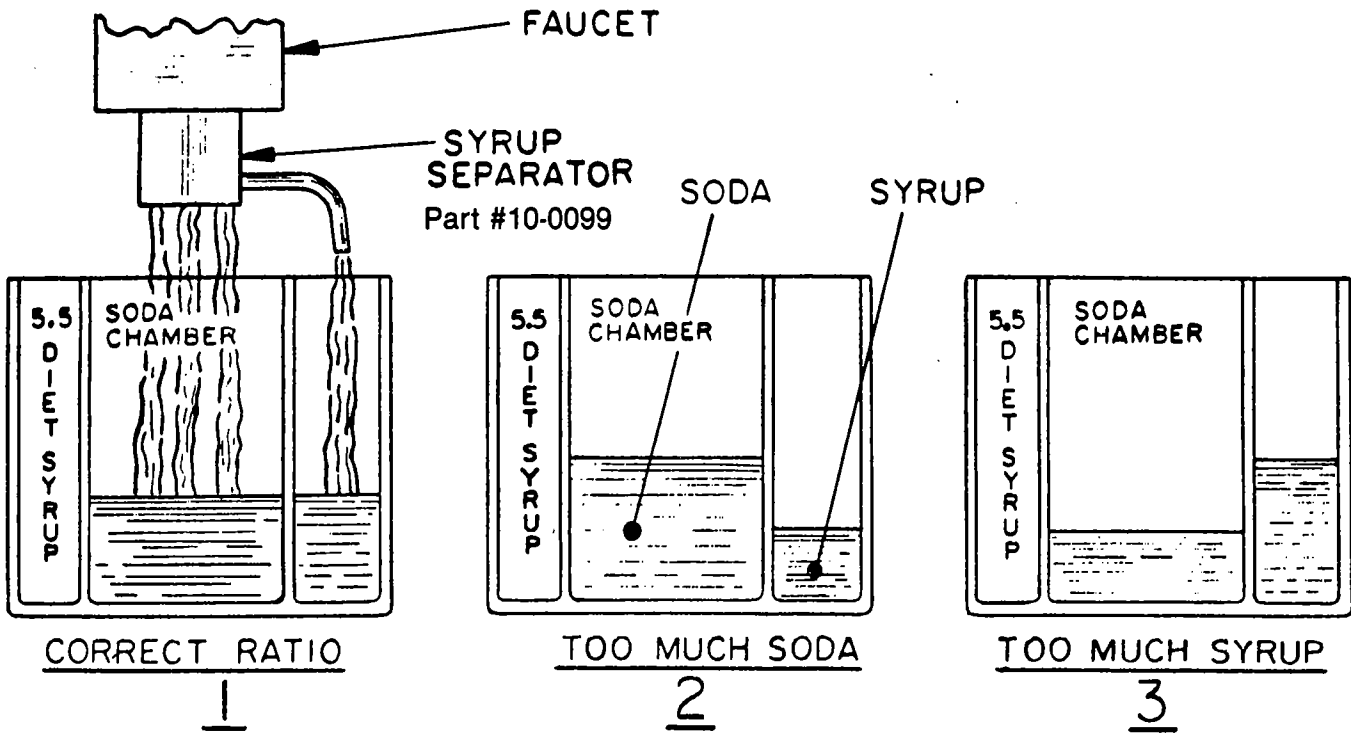

Fig. 21 — Brixing Procedure

PROCEDURES USING BRIX CUP FOR PROPER MIXING OF SYRUP AND SODA

NOTE: Brix Cups are available with different ratios.

| Syrup | Diet Syrup |
|-----------|------------|
| 5 to 1 | 5.5 to 1 |
| 4.75 to 1 | 5.5 to 1 |
| 4.50 to 1 | 5.5 to 1 |

1. Remove spout from faucet, replace with syrup separator. Have separator pushed up to faucet body with arm of separator extending to the right of faucet, as shown below (Fig. 21).
2. The faucet will contain either (not both) *flow controls* or *metering stems*, to adjust syrup and water flow. Faucets with flow controls have adjustments on the top (under cover). Those faucets without flow controls have metering stems on the bottom side of valve. The soda and syrup adjustments are plainly marked.
3. Place Brix Cup under faucet and syrup separator as shown (Fig. 21).
4. *Adjust soda flow first* — With the syrup disconnected or turned off, set the soda water to desired rate of flow.
5. *Syrup adjustment* — Actuate faucet lever and allow both the soda and syrup to flow into Brix Cup as shown (Fig. 21). After 2 or 3 ounces of soda has been dispensed, see if the soda and syrup *levels are equal*, as shown (Fig. 21-1). Then the mixture is correct. If the levels are *not equal* as shown (Fig. 21-2 and Fig. 21-3) make the following adjustments:
 - A. If the syrup level is below the soda level (Fig. 21-2):
 1. For the faucet with *flow controls*, turn syrup adjustment clockwise to increase syrup flow.
 2. If the faucet has *metering stems*, turn syrup adjustment counter clockwise to increase syrup flow.
 - B. If the syrup level is above the soda level (Fig. 21-3):
 1. For the faucet with *flow controls*, turn the syrup adjustment counter clockwise to decrease syrup flow.
 2. If the faucet has *metering stems*, turn the syrup adjustment clockwise to decrease the syrup flow.

Parts List/Callout Reference Chart

1. Spring
2. Grill — Wire
3. Positive Drive Belt
4. Lip Seal (part of Item 7)
5. Key Stock — $\frac{3}{16}$ " sq. x 1" lg. for use with Drive Pulleys
6. Pin
7. Upper Drive Shaft Housing Assembly
8. Sleeve Bearing (Part of Item 7)
9. Bearing $\frac{5}{8}$ " OD x $\frac{5}{16}$ " thick
10. Large Drive Pulley Assembly
11. Small Drive Pulley Assembly with Keyway
12. Upper Bearing Coupling
13. Agitator Drive Coupling
14. Agitator Flighting
15. Agitator Bearing 1.625" ID
16. Auger Bearing 1.334" ID
17. Thumbscrew — $\frac{8}{32}$ " x $\frac{7}{16}$ " B60030 Ice Chute
18. Thumbscrew — #8 x $\frac{1}{2}$ Type A
19. Capscrew $\frac{1}{4}$ — 20 Torx Head
20. #8-32 x $1\frac{1}{4}$ " Phil/Tr MS/Zinc
21. $\frac{1}{4}$ — 20 x 1 Full Thread MS SS
22. Thumbscrew Plastic
23. Cage Nut
24. Washer $1\frac{3}{8}$ " OD
25. Tensioner Bearing
26. Drain Fitting Assembly
27. Hinge Pin
28. Auger Access Panel
29. Weldment Agitator Shaft Paddle
30. Cover Switch Box
31. Product Inlet Lines
32. Switch Box Cover
33. Drain Fitting Bracket
34. Agitator Shaft Washer
35. Gear Motor Lock Bracket
36. Gear Box Angle Bracket
37. Electrical Box — Switch
38. Cover — Base Hole
39. Tie Strap
40. Clip — Spring Hinge Pin
41. Door — Living Hinge Polypropylene
42. Insert/Mounting Strip Spotweld
43. Agitator Bearing Bracket Weld
44. 4" OD Auger Assembly
45. Auger Bearing Bracket
46. Bracket Ice Outlet Door Mounting
47. Agitator Shaft — Pin Weld
48. Ice Chute
49. Belt Tensioner Mounting Bracket Weld
50. Drain Pan Wrapper
51. Left-hand Lower Front Trim
52. Right-hand Lower Front Trim
53. Top Cover (Black)
54. Lower Front Panel
55. Switch/Actuator Pilot Duty
56. Relay — Electronic
57. Sinpac Switch
58. Drive Motor/Gear Reducer
59. Valve — Post Mix
60. Start Capacitor Bracket
61. Actuating Arm — Two-hand
62. Actuating Arm — Glass Fill
63. Drain Fitting Filler Plate
65. Lower Drive Shaft/Housing Assembly
66. Drain Pan Assembly
67. Soda Manifold
68. Front Panel Assembly
69. Lower Back Panel Assembly
72. Small Drive Pulley Assembly Without Keyway
73. Roll Pin
74. Shim Angle Weld
75. Spring Belt Tensioner
76. Bracket — Spring Belt Tightener
77. Gasket — Upper Drive Shaft Housing
78. Drain Pan Hose Seal
79. Control Box
80. Transformer Box
81. Transformer 115V Primary — 24V Secondary

DISPENSER WIRING DIAGRAM - 230V, 50HZ

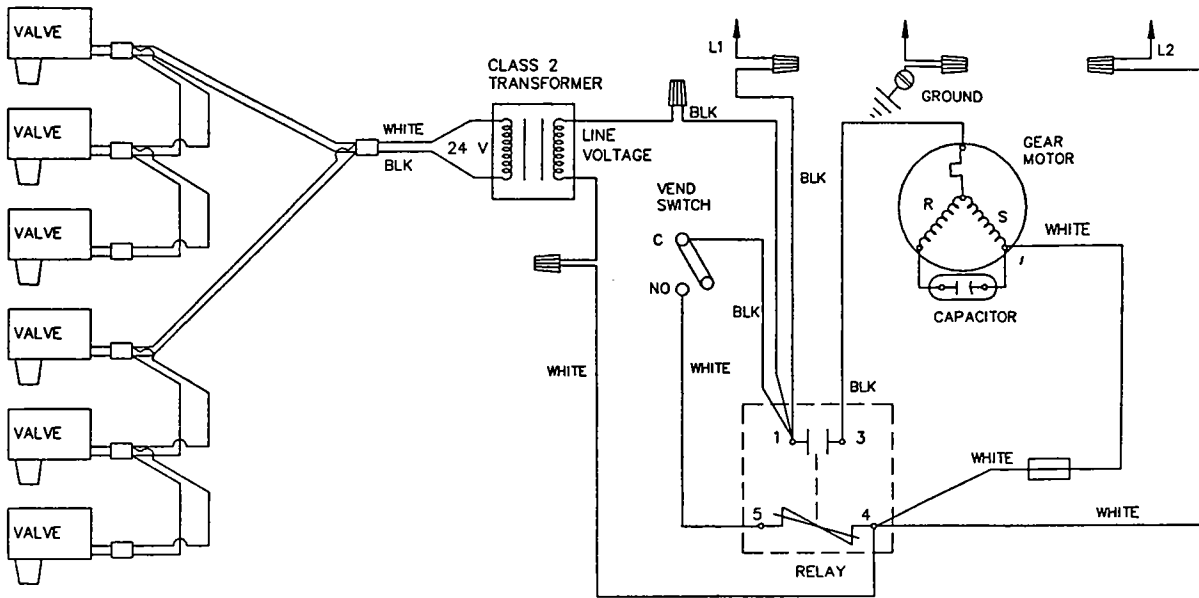

Free Manuals Download Website

<http://myh66.com>

<http://usermanuals.us>

<http://www.somanuals.com>

<http://www.4manuals.cc>

<http://www.manual-lib.com>

<http://www.404manual.com>

<http://www.luxmanual.com>

<http://aubethermostatmanual.com>

Golf course search by state

<http://golfingnear.com>

Email search by domain

<http://emailbydomain.com>

Auto manuals search

<http://auto.somanuals.com>

TV manuals search

<http://tv.somanuals.com>