

**Compact**<sup>™</sup>  
Made by Manitowoc<sup>®</sup>

# **SERVICE TECHNICIAN'S HANDBOOK**

## **CM Model Ice Machines**

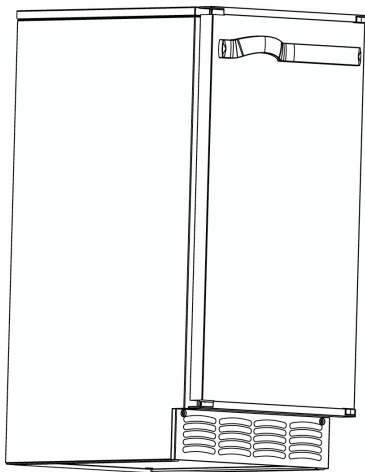

This manual is updated as new  
Information and models are released  
Visit our website for the latest manual:  
[www.compact-ice.com](http://www.compact-ice.com)

STH003  
06/06

©Manitowoc Ice, Inc.

## Safety Notices

When using or servicing these Ice Machines, be sure to pay close attention to the safety notices in this handbook. Disregarding the notices may lead to serious injury and/or damage to the ice machine.

Throughout this handbook, you will see the following types of safety notices:



### **WARNING**

Text in a Warning box alerts you to a potential personal injury situation. Be sure to read the Warning statement before proceeding, and work carefully.



### **CAUTION**

Text in a Caution box alerts you to a situation in which you could damage the ice machine. Be sure to read the Caution statement before proceeding, and work carefully.

## Procedural Notices

When using or servicing these Ice Machines, be sure to read the procedural notices in this handbook. These notices supply helpful information that may assist you as you work.

Throughout this handbook, you will see the following types of procedural notices:

### **IMPORTANT**

Text in an Important box provides you with information that may help you perform a procedure more efficiently. Disregarding this information will not cause damage or injury, but may slow you down as you work.

**NOTE:** Text set off as a Note provides you with simple, but useful extra information about the procedure you are performing.

## Read These Before Proceeding:



### CAUTION

Proper installation, care and maintenance are essential for maximum ice production and trouble free operation of your Compact Ice Machine. Read and understand this manual. If you encounter problems not covered by this manual, do not **proceed**, contact Manitowoc Ice, Inc. We will be happy to provide assistance.

### IMPORTANT

Routine adjustments and maintenance procedures outlined in this manual are not covered by the warranty.

We reserve the right to make product improvements at any time. Specifications and design are subject to change without notice.



### WARNING

#### PERSONAL INJURY POTENTIAL

Do not operate equipment that has been, misused, abused, neglected, damaged, or altered/modified from that of original manufactured specifications.



### WARNING

#### POTENTIAL PERSONAL INJURY SITUATION

This ice machine contains refrigerant charge. Installation and brazing of the line sets must be performed by a properly trained refrigeration technician aware of the **Dangers of dealing with refrigerant** charged equipment. The technician must also be US Government Environmental Protection Agency (EPA) certified in proper refrigerant handling and servicing procedures.

# TABLE OF CONTENTS

<b>GENERAL INFORMATION.....</b>	<b>7</b>
<b>MODEL NUMBERS.....</b>	<b>7</b>
<b>ACCESSORIES.....</b>	<b>8</b>
<b>MODEL/SERIAL NUMBER LOCATION .....</b>	<b>9</b>
<b>OWNER WARRANTY REGISTRATION.....</b>	<b>9</b>
<b>INSTALLATION .....</b>	<b>13</b>
<b>LOCATION OF ICE MACHINE .....</b>	<b>13</b>
<b>ICE MACHINE HEAT OF REJECTION .....</b>	<b>14</b>
<b>LEVELING THE ICE MACHINE .....</b>	<b>15</b>
<b>WATER SERVICE/DRAINS .....</b>	<b>16</b>
<b>ELECTRICAL REQUIREMENTS.....</b>	<b>18</b>
<b>COMPONENT IDENTIFICATION .....</b>	<b>19</b>
<b>OPERATIONAL CHECKS .....</b>	<b>19</b>
<b>MAINTENANCE .....</b>	<b>23</b>
<b>ICE MACHINE INSPECTION .....</b>	<b>23</b>
<b>EXTERIOR CLEANING.....</b>	<b>23</b>
<b>CLEANING THE CONDENSER .....</b>	<b>23</b>
<b>INTERIOR CLEANING AND SANITIZING.....</b>	<b>25</b>
<b>CLEANING PROCEDURE .....</b>	<b>28</b>
<b>REMOVAL OF PARTS FOR CLEANING AND     SANITIZING.....</b>	<b>31</b>
<b>ICE MAKING SEQUENCE OF OPERATION..</b>	<b>39</b>
<b>TROUBLESHOOTING .....</b>	<b>41</b>
<b>DIAGNOSING AN ICE MACHINE THAT     WILL NOT RUN.....</b>	<b>41</b>
<b>ICE MACHINE WILL NOT HARVEST.....</b>	<b>43</b>
<b>ICE QUALITY IS POOR – CUBES ARE     SHALLOW, INCOMPLETE OR WHITE .....</b>	<b>44</b>
<b>FREEZE CYCLE IS LONG, LOW ICE     PRODUCTION .....</b>	<b>45</b>
<b>ICE MACHINE RUNS &amp; NO ICE IS     PRODUCED.....</b>	<b>46</b>
<b>ANALYZING DISCHARGE PRESSURE.....</b>	<b>47</b>
<b>ANALYZING SUCTION PRESSURE .....</b>	<b>49</b>

<b>HOT GAS VALVE.....</b>	<b>52</b>
<b>BIN THERMOSTAT.....</b>	<b>55</b>
<b>ICE PRODUCTION CHECK.....</b>	<b>57</b>
<b>ADJUSTING CUBE WEIGHT .....</b>	<b>58</b>
<b>LIQUID LINE THERMISTOR .....</b>	<b>59</b>
<b>TOTAL SYSTEM REFRIGERATION</b>	
<b>CHARGE.....</b>	<b>61</b>
<b>COMPONENT SPECIFICATIONS AND CHECK</b>	
<b>PROCEDURES .....</b>	<b>62</b>
<b>MAIN FUSE .....</b>	<b>62</b>
<b>COMPRESSOR ELECTRICAL</b>	
<b>DIAGNOSTICS.....</b>	<b>63</b>
<b>DIAGNOSING START COMPONENTS: ....</b>	<b>65</b>
<b>CYCLE TIMES, 24 HR ICE PRODUCTION AND</b>	
<b>REFRIGERANT PRESSURE CHARTS .....</b>	<b>66</b>
<b>REFRIGERANT DEFINITIONS .....</b>	<b>68</b>
<b>REFRIGERANT RE-USE POLICY .....</b>	<b>69</b>
<b>SYSTEM CONTAMINATION CLEANUP ...</b>	<b>75</b>
<b>SEVERE SYSTEM CONTAMINATION</b>	
<b>CLEANUP PROCEDURE .....</b>	<b>ERROR!</b>
<b>BOOKMARK NOT DEFINED.</b>	
<b>REPLACING PRESSURE CONTROLS</b>	
<b>WITHOUT REMOVING REFRIGERANT</b>	
<b>CHARGE.....</b>	<b>80</b>
<b>BRAZING PROCEDURES FOR DANFOSS</b>	
<b>SOLENOID VALVES .....</b>	<b>82</b>
<b>FILTER-DRIERS.....</b>	<b>84</b>
<b>CONTROL BOARD .....</b>	<b>85</b>
<b>WIRING DIAGRAMS .....</b>	<b>88</b>
<b>TUBING SCHEMATIC.....</b>	<b>87</b>

# **GENERAL INFORMATION**

## **MODEL NUMBERS**

This manual covers the following models:

**CMS050A004**



### **WARNING**

An ice machine contains high voltage electricity and refrigerant charge. Repairs are to be performed by properly trained refrigeration technicians aware of the dangers of dealing with high voltage electricity and refrigerant under pressure.

## ACCESSORIES

Visit our website at: [www.compact-ice.com](http://www.compact-ice.com) for these optional accessories:

### LEGS

Four inch adjustable legs are available.

### DRAIN PUMP

Pumps waste water from ice machine to drain.

### MANITOWOC ICE MACHINE CLEANER AND SANITIZER

These are the only cleaner and sanitizer approved for use with Compact products.

Cleaner Part Number	Sanitizer Part Number
16oz 000000084	16oz 94-0565-3



#### CAUTION

Use only Manitowoc approved Ice Machine Cleaner (part number 94-0546-3 original green ice machine cleaner or 000000084 clear metal safe ice machine cleaner) and Sanitizer (part number 94-0565-3). It is a violation of Federal law to use these solutions in a manner inconsistent with their labeling. Read and understand all labels printed on bottles before use.



## MODEL/SERIAL NUMBER LOCATION

The model and serial numbers are required when requesting information from your local Compact retailer or Compact Ice at 800-235-9698. The model and serial number are listed on the MODEL/SERIAL NUMBER DECAL affixed to the ice machine

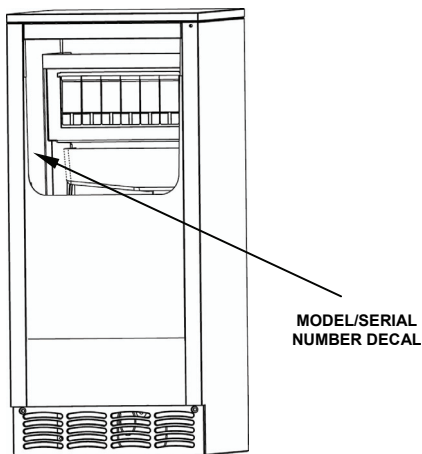
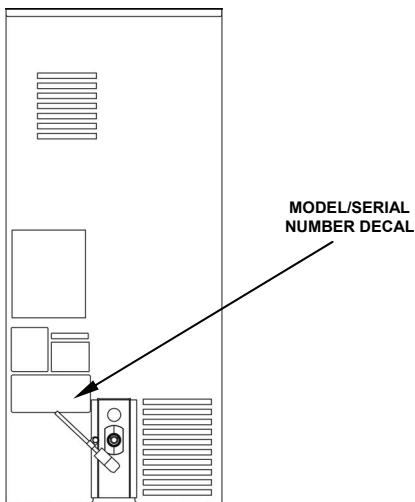

# OWNER WARRANTY REGISTRATION CARD

## GENERAL

The packet containing this manual also includes warranty information. Warranty coverage begins the day you purchase your new ice machine.

### Compact CM Series Limited Ice Machine Warranty

Subject to the exclusions and limitations below, Manitowoc Ice, Inc. (“**Manitowoc Ice**”) warrants this CM Series Ice Machine (the “**Product**”) against defects in material or workmanship as follows:

1. **Labor.** For a period of ninety (90) days from the date of purchase by the consumer (“**Purchaser**”), if the Product is determined to be defective, Manitowoc Ice shall, at its option, replace the Product or pay the labor charges to any authorized Manitowoc Ice service facility to repair the Product. After expiration of the ninety day (90) period referred above, the Purchaser must pay all labor charges.
2. **Parts.** In addition, for a period of twelve (12) months from the date of purchase by the Purchaser, if the Product is determined to be defective, Manitowoc Ice shall, at its option, replace the Product or provide new or rebuilt replacement parts for the Product at no charge.

REPAIR OR REPLACEMENT AS PROVIDED ABOVE IS THE PURCHASER’S SOLE AND EXCLUSIVE REMEDY UNDER THIS LIMITED WARRANTY.

This limited warranty only applies to the original Purchaser of the Product and is not transferable. This limited warranty is valid only in the United States. This limited warranty does not apply to: (1) any cost or expense associated with shipping, accessing, removing, installing or reinstalling the Product to obtain warranty service, including, without limitation, expenses related to remodeling or repairing any flooring, cabinetry or the like; (2) periodic or routine maintenance; (3) repair or replacement of the Product or parts due to normal wear and tear; (4) defects or damage to the Product or parts resulting from misuse, abuse, neglect, or accidents; (5) defects or damage to the Product or parts resulting from improper or unauthorized alterations, modifications, or changes; (6) any Product that has not been installed in accordance with the instruction manual or technical instructions provided by Manitowoc Ice; and (7) any Product that has not been maintained, cleaned or sanitized in accordance with the instruction manual or technical instructions provided by Manitowoc Ice. To the extent that warranty exclusions are not permitted under some state laws, these limitations or exclusions may not apply to you.

EXCEPT AS STATED IN THE FOLLOWING SENTENCE, THIS LIMITED WARRANTY IS THE SOLE AND EXCLUSIVE WARRANTY OF MANITOWOC ICE WITH REGARD TO THE PRODUCT. ALL IMPLIED WARRANTIES ARE STRICTLY LIMITED TO THE DURATION OF THE LIMITED WARRANTY APPLICABLE TO THE PRODUCTS AS STATED ABOVE, INCLUDING BUT NOT LIMITED TO, ANY WARRANTY OF MERCHANTABILITY OR OF FITNESS FOR A PARTICULAR PURPOSE. Some states do not allow limitations on how long an implied warranty lasts, so the above limitation may not apply to you.

IN NO EVENT SHALL MANITOWOC ICE OR ANY OF ITS AFFILIATES BE LIABLE TO THE PURCHASER OR ANY OTHER PERSON FOR ANY INCIDENTAL, CONSEQUENTIAL OR SPECIAL DAMAGES OF ANY KIND ARISING FROM OR IN ANY MANNER CONNECTED WITH THE PRODUCT, ANY BREACH OF THIS LIMITED WARRANTY, OR ANY OTHER CAUSE. Some states do not allow the exclusion or limitation of incidental or consequential damages, so the above limitation or exclusion may not apply to you.

This limited warranty gives the Purchaser specific legal rights, and the Purchaser may also have rights that vary from state to state or from one jurisdiction to another. To obtain warranty service or information regarding the Product, please contact us at:

MANITOWOC ICE, INC.  
2110 So. 26th Street  
P.O. Box 1720  
Manitowoc, WI 54221-1720  
Telephone: 800-235-9698

In order to obtain warranty service, the Purchaser must present proof of purchase which shows that the Purchaser was the original purchaser and that the Product is within the warranty periods described above.

To secure prompt and continuing warranty service, the warranty registration card must be completed and sent to Manitowoc Ice within thirty (30) days from the date of purchase by the Purchaser. Complete the enclosed registration card and send it to Manitowoc Ice at the address shown above. Retain a copy for your record.

# INSTALLATION

## LOCATION OF ICE MACHINE

The location selected for the ice machine must meet the following criteria. If any of these criteria are not met, select another location.

- The location must be indoors.
- The location must be free of airborne and other contaminants.
- Air temperature: must be at least 50°F (10°C) but must not exceed 110°F (43°C).
- The location must not be near heat-generating equipment or in direct sunlight.
- The location must be capable of supporting the weight of the ice machine and a full bin of ice.
- The location must allow enough clearance for water, drain, and electrical connections in the **rear of the ice machine**.
- The location must not obstruct airflow through or around the ice machine (condenser airflow is in and out the front). Refer to the chart below for clearance requirements.

	<b>Self-Contained Air-Cooled</b>	<b>Self-Contained Water-Cooled</b>
Top/Sides	5" (127 mm)*	5" (127 mm)*
Back	5" (127 mm)*	5" (127 mm)*

\*NOTE: The ice machine may be built into a cabinet.

There is no minimum clearance requirement for the top or left and right sides of the ice machine. The listed values are recommended for efficient operation and servicing only.



### CAUTION

The ice machine must be protected if it will be subjected to temperatures below 32 F (0 C). Failure caused by exposure to freezing temperatures is not covered by the warranty.

## ICE MACHINE HEAT OF REJECTION

Heat of Rejection*	
Air Conditioning**	Peak
1,145	2,300

\* B.T.U./Hour

\*\* Because the heat of rejection varies during the ice making cycle, the figure shown is an average.

Ice machines, like other refrigeration equipment, reject heat through the condenser. It is helpful to know the amount of heat rejected by the ice machine when sizing air conditioning equipment where self-contained air-cooled ice machines are installed.

## LEVELING THE ICE MACHINE

After moving the ice machine into the installation location, it must be leveled for proper operation. Follow these steps to level the ice machine:

1. Use a level to check the levelness of the ice machine from front to back and from side to side.
2. If the ice machine is not level, adjust the leveling glides or legs on each corner of the base of the ice machine as necessary.
3. Check the levelness of the ice machine after each adjustment.
4. Repeat steps 2 and 3 until the ice machine is level from front to back and from side to side.

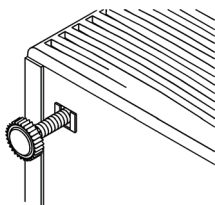

**Levelers**

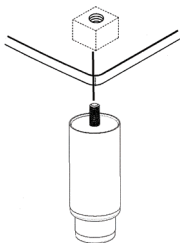

**Legs**

## **WATER SERVICE/DRAINS**

### **WATER SUPPLY**

Local water conditions may require treatment of the water to inhibit scale formation, filter sediment, and remove chlorine odor and taste.

#### **IMPORTANT**

If you are installing a Manitowoc water filter system, refer to the Installation Instructions supplied with the filter system for ice making water inlet connections.

### **WATER INLET LINES**

Follow these guidelines to install water inlet lines:

- Do not connect the ice machine to a hot water supply. Be sure all hot water restrictors installed for other equipment are working. (Check valves on sink faucets, dishwashers, etc.)
- If water pressure exceeds the maximum recommended pressure, 80 psig (5.5 bar) obtain a water pressure regulator from your Manitowoc distributor.
- Install a water shut-off valve for ice making potable water.
- Insulate water inlet lines to prevent condensation.
- Local, state or city codes may require an air gap. Contact a local plumber for code requirements.

### **DRAIN CONNECTIONS**

Follow these guidelines when installing drain lines to prevent drain water from flowing back into the ice machine and storage bin:

- Drain lines must have a 1.5-inch drop per 5 feet of run (2.5 cm per meter), and must not create traps.
- The floor drain must be large enough to accommodate drainage from all drains.



## WATER SUPPLY AND DRAIN LINE SIZING/CONNECTIONS

	Water Temperature	Water Pressure	Ice Machine Fitting	Tubing Size Up to Ice Machine Fitting
<b>Ice Making Water Inlet</b>	35°F (1.7°C) Min. 90°F (32.°C) Max.	20 psi (1.38 bar) Min 80 psi (5.5 bar) Max	1/4" (.64 cm) ID Copper Tubing	1/4" (.64 cm) min. inside diameter
<b>Bin Drain</b>	-----.	-----	3/4" (1.9 cm) Hose Barb	3/4" (1.9 cm) minimum inside diameter
<b>Drain Pump</b>	-----	-----	3/8" (.96 cm) Hose	3/8" (.96 cm) ID minimum
<b>Note:</b> If air temperature is less than 60 F (15.5 C) water temperature must be equal or greater than 50°F (10°C).				

## ELECTRICAL REQUIREMENTS

### VOLTAGE

The maximum allowable voltage variation is  $\pm 10\%$  of the rated voltage on the ice machine model/serial number plate at start-up (when the electrical load is highest).

- A qualified electrician must determine proper wire size dependent upon location, materials used and length of run (minimum circuit ampacity can be used to help select the wire size).
- The maximum allowable voltage variation is  $\pm 10\%$  of the rated voltage at ice machine start-up (when the electrical load is highest).
- Check all green ground screws in the control box and verify they are tight before starting the ice machine.

### MINIMUM CIRCUIT AMPACITY

The minimum circuit ampacity is used to help select the wire size of the electrical supply. (Minimum circuit ampacity is not the ice machine's running amp load.)

### ELECTRICAL SPECIFICATIONS



#### WARNING

The ice machine must be grounded in accordance with national and local electrical code.

Ice Machine	Voltage Phase Cycle	Max. Fuse/ Circuit Breaker	Minimum Circuit Amps
CM50	115/1/60	15 amp	4.1

### GFCI REQUIREMENTS

If GFCI (ground fault circuit interrupter) is required by local electrical code, it must be a breaker type.

# COMPONENT IDENTIFICATION

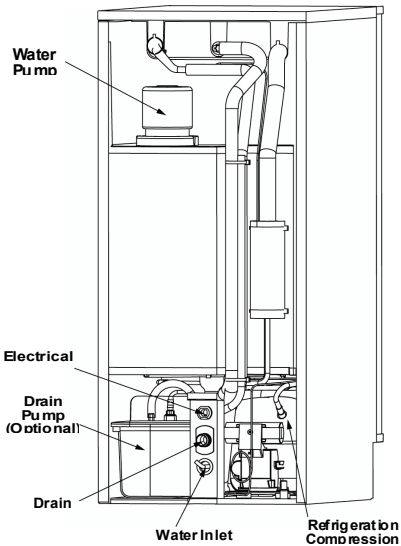
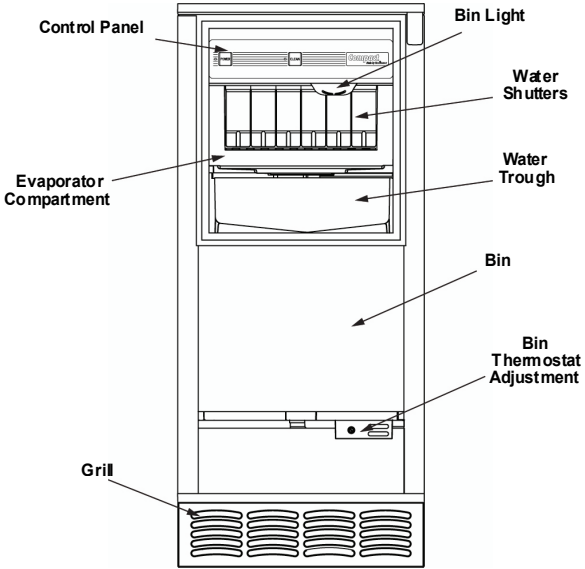

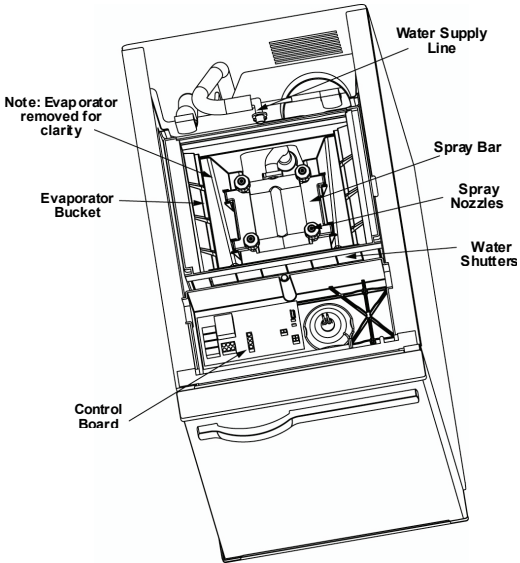
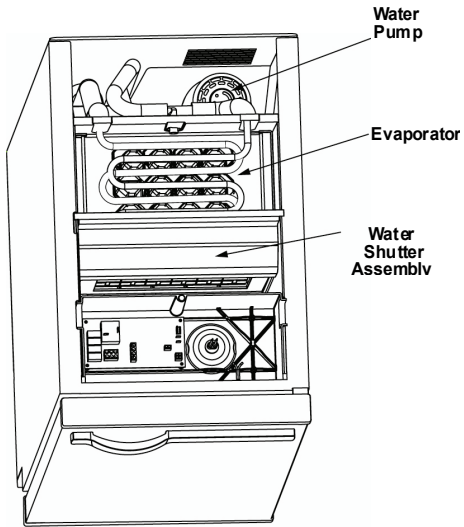

## **OPERATIONAL CHECKS**

Routine adjustments and maintenance procedures outlined in this manual are not covered by the warranty

### **WATER INLET VALVE**

The water inlet valve energizes in the harvest cycle. The water level will rise and flow out the overflow tube and down the drain. Verify the overflow tube is in place in the water trough. The water level is not adjustable.

### **BIN THERMOSTAT ADJUSTMENT**

The bin thermostat stops the ice machine when the bin is full. Turn the thermostat to the left to decrease the level of ice in bin or to the right to increase the level of ice in bin.

### **POWER BUTTON (GREEN)**

Pressing the "Power" button once will energize the ice machine and green Power light. Pressing the "Power" button a second time will de-energize the ice machine.

### **CLEAN (GREEN)**

Pressing the "Clean" button will initiate a clean cycle. The clean light will flash during the clean cycle for one minute to indicate the proper time to add ice machine cleaner or sanitizer.

## **SAFETY TIMERS**

The control board has the following non-adjustable safety timers:

- Initial cycle is 5 minutes longer than subsequent cycles.
- The ice machine is locked into the freeze cycle for 10 minutes (15 minutes initial cycle) before a harvest cycle can be initiated.
- The maximum freeze time is 120 minutes at which time the control board automatically initiates a harvest cycle (step 4).
- The maximum harvest time is 5 minutes at which time the control board automatically start a freeze cycle

# MAINTENANCE

## ICE MACHINE INSPECTION

Check all water fittings and lines for leaks. Also, make sure the refrigeration tubing is not rubbing or vibrating against other tubing, panels, etc.

Do not put anything (boxes, etc.) in front of the ice machine. There must be adequate airflow through and around the ice machine to maximize ice production and ensure long component life.

## EXTERIOR CLEANING

Clean the area around the ice machine as often as necessary to maintain cleanliness and efficient operation.

Sponge any dust and dirt off the outside of the ice machine with mild soap and water. Wipe dry with a clean, soft cloth.

A commercial grade stainless steel cleaner/polish can be used as necessary.

## CLEANING THE CONDENSER



### WARNING

Disconnect electric power to the ice machine at the electric service switch before cleaning the condenser.



### CAUTION

If you are cleaning the condenser fan blades with water, cover the fan motor to prevent water damage.

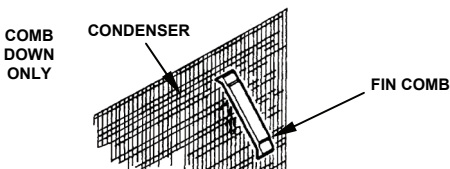

## AIR-COOLED CONDENSER

A dirty condenser restricts airflow, resulting in excessively high operating temperatures. This reduces ice production and shortens component life. Clean the condenser at least every six months. Follow the steps below.



### WARNING

The condenser fins are sharp. Use care when cleaning them.

1. The washable aluminum filter on self-contained air-cooled ice machines is designed to catch dust, dirt, lint and grease. This helps keep the condenser clean. Clean the filter with a mild soap and water solution.
2. Clean the outside of the condenser with a soft brush or a vacuum with a brush attachment. Clean from top to bottom, not side to side. Be careful not to bend the condenser fins.
3. Shine a flashlight through the condenser to check for dirt between the fins. If dirt remains:
  - a) Blow compressed air through the condenser fins from the inside. Be careful not to bend the fan blades.
  - b) Use a commercial condenser coil cleaner. Follow the directions and cautions supplied with the cleaner.
4. Straighten any bent condenser fins with a fin comb.
5. Carefully wipe off the fan blades and motor with a soft cloth. Do not bend the fan blades. If the fan blades are excessively dirty, wash with warm, soapy water and rinse thoroughly.



## INTERIOR CLEANING AND SANITIZING



### CAUTION

Use only Manitowoc approved Ice Machine Cleaner (part number 000000084 clear metal safe ice machine cleaner) and Sanitizer (part number 94-0565-3). It is a violation of Federal law to use these solutions in a manner inconsistent with their labeling. Read and understand all labels printed on bottles before use.



### CAUTION

Do not mix Ice Machine Cleaner and Sanitizer solutions together. It is a violation of Federal law to use these solutions in a manner inconsistent with their labeling.



### WARNING

Wear rubber gloves and safety goggles (and/or face shield) when handling Ice Machine Cleaner or Sanitizer.



### WARNING

Disconnect all electric power to the ice machine before cleaning and sanitizing.

## INTERIOR CLEANING AND SANITIZING

### GENERAL

Perform an In Place Cleaning/Sanitizing procedure monthly and a Cleaning/Sanitizing procedure every 12 months for efficient operation. If the ice machine requires more frequent cleaning and sanitizing, consult a qualified service company to test the water quality and recommend appropriate water treatment. An extremely dirty ice machine must be taken apart for cleaning and sanitizing.



#### CAUTION

Damage to the ice machine evaporator caused by incorrect chemical usage is not covered by the warranty. Use Manitowoc Ice Machine Cleaner (part number 000000084) and Sanitizer (part number 94-0565-3) only.

### IN PLACE CLEANING/SANITIZING PROCEDURE

This procedure allows monthly in place cleaning of all surfaces that come in contact with the water system. The ice machine requires disassembly and cleaning/sanitizing a minimum of once every 12 months. The quality of your potable water supply may require more frequent cleaning intervals.

Use ice machine cleaner to remove lime scale or other mineral deposits. Ice machine sanitizer disinfects and removes algae and slime.



#### WARNING

Follow all labels and warnings on cleaner and sanitizer bottles.

**NOTE:** All ice must be removed from the bin.

**Step 1** Prepare 4 oz (1/2 cup) of undiluted Manitowoc Ice Machine Cleaner (part number 000000084 only) in a container that will fit easily under the lifted water shutters.

**Step 2** Press the clean switch. The ice machine will initiate a 2 minute harvest to remove any remaining ice from the evaporator.

**Step 3** Remove all ice from the bin.

**Step 4** Wait 3 minutes until the Clean light flashes, then add the prepared Manitowoc Cleaner by lifting the water shutters and pouring directly into the spray area.

**Step 5** The ice machine will automatically time out a ten minute cleaning cycle, followed by eight rinse cycles, and stop. The Clean light will turn off to indicate the clean cycle is complete. This entire cycle lasts approximately 30 minutes.

**Step 6** Prepare 1/2 oz (1 tablespoon) of undiluted Manitowoc Ice Machine Sanitizer (part number 94-0565-3 only) in a container that will fit into the same area.

**Step 7** Press the Clean switch. Wait 3 minutes until the Clean light flashes, then add the prepared Manitowoc Sanitizer by lifting the water shutters and pouring directly into the spray area. The ice machine will automatically time out a ten minute sanitizing cycle, followed by eight rinse cycles, and stop. The Clean light will turn off to indicate the sanitizing cycle is complete. This entire cycle lasts approximately 30 minutes.

NOTE: The ice machine will automatically continue from the previous point before the clean cycle was initiated.

- A. If the ice machine was in the ice making cycle, the control board will start ice making again.
- B. If the ice machine was in the off cycle, the control board will turn off.

## CLEANING PROCEDURE

Ice machine cleaner is used to remove lime scale and other mineral deposits. Ice machine sanitizer disinfects and removes algae and slime.

**NOTE:** All ice must be removed from the bin.

**Step 1** Prepare 4 oz (1/2 cup) of undiluted Manitowoc Ice Machine Cleaner (part number 000000084 only) in a container that will fit easily under the lifted water shutters. Refer to page 3-1 to identify the water shutters.

**Step 2** Press the Clean switch. The ice machine will initiate a 2 minute harvest to remove any remaining ice from the evaporator.

**Step 3** Remove all ice from the bin.

**Step 4** Wait 3 minutes until the Clean light flashes, then add the prepared Manitowoc Cleaner by lifting the water shutters and pouring directly into the spray area. The ice machine will automatically time out a ten minute cleaning cycle, followed by eight rinse cycles, and stop. The Clean light will turn off to indicate the clean cycle is complete. This entire cycle lasts approximately 30 minutes.

**Step 5** When the cleaning process stops, disconnect power and remove all parts as described in Removal of Parts for Cleaning and Sanitizing.

**Step 6** Mix 16 oz (2 cups) cleaner with 2 gal of warm water.



### CAUTION

Do not mix Cleaner and Sanitizer solutions together. It is a violation of Federal law to use these solutions in a manner inconsistent with their labeling.

**Step 7** Take all removed components to a sink for cleaning. Use 1/2 of the cleaner/water mixture to clean all components. The cleaner solution will foam when it contacts lime scale and mineral deposits; once the foaming stops, use a soft-bristle nylon brush, sponge or cloth (NOT a wire brush) to carefully clean the parts. Disassemble the spray bar, remove nozzles and inserts and soak for 5 minutes. For heavily scaled parts, soak in solution for 15 – 20 minutes. Rinse all components with clean water.

**Step 8** While components are soaking, use the other 1/2 of the cleaner/water solution and a nylon brush or cloth to clean inside of ice bin. Clean inside of door, door gasket, bin, top of evaporator and evaporator bucket. Rinse all areas thoroughly with clean water.

**Step 9** Mix 1 oz (2 tablespoons) sanitizer with 2 gal of warm water.

**Step 10** Use 1/2 of the sanitizer/water mixture to sanitize all removed components. Use a cloth or sponge to liberally apply the solution to all surfaces of the removed parts or soak the removed parts in the sanitizer/solution. Rinsing is not required.

**Step 11** Use the other 1/2 of the sanitizer/water solution and a sponge or cloth to sanitize the inside of ice bin. Sanitize inside of door, door gasket, bin, top of evaporator and evaporator bucket. Rinsing is not required.

**Step 12** Replace all removed components.

**Step 13** Prepare 1/2 oz (1 tablespoon) of undiluted Manitowoc Sanitizer.

**Step 14** Reapply power to the ice machine, then press the Clean switch.

**Step 15** Wait 3 minutes until the Clean light flashes, then add the prepared Manitowoc Sanitizer by lifting the water shutters and pouring directly into the spray area. The ice machine will automatically time out a ten minute sanitizing cycle, followed by eight rinse cycles, and stop. The Clean light will turn off to indicate the sanitizing cycle is complete. This entire cycle lasts approximately 30 minutes.

NOTE: The ice machine will automatically continue from the previous point before the clean cycle was initiated.

- A. If the ice machine was in the ice making cycle, the control board will start ice making again.
- B. If the ice machine was in the off cycle, the control board will turn off.

## **REMOVAL OF PARTS FOR CLEANING AND SANITIZING**

### **TOP COVER**

1. Remove two back screws.
2. Slide back and lift cover off.



### **WARNING**

Disconnect electric power to the ice machine at the electric switch box before proceeding.

## WATER SHUTTERS

The water shutter is designed to keep the spraying water from escaping the evaporator compartment.

To remove just the water shutters:

1. Grasp one end of the water shutter and lift up.
2. Pivot water shutter and disengage remaining end.
3. To re-install into ice machine, grasp one end of the water shutters, install one end, pivot the opposite end and pull down into position. Make sure tabs are secure in grooves.

To remove water shutter assembly:

1. Slide evaporator bucket forward 1/2" (13 mm).
2. Lift shutter assembly straight up.

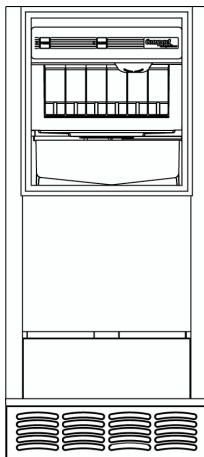
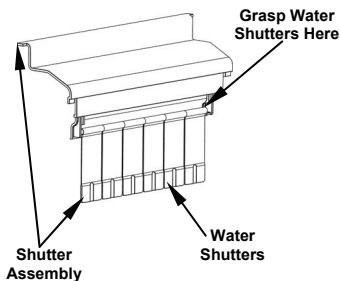

### WARNING

Removing the water shutters while the water pump is running will allow water to spray from ice machine. Disconnect the electrical power to the ice machine at the electric service switch box and turn off the water supply.



## ICE CHUTE

The ice chute is positioned over the spray nozzles and allows the ice to easily fall into the bin. It must be firmly positioned over the spray bar, with the front edge inside the water trough. Spray nozzles must align with the spray holes or spray water will fall into the bin.

1. Grab protruding spray hole on one end and lift up and remove.
2. To re-install ice chute, grasp protruding spray hole and position over Water Distribution Assembly. Make sure rear supports are over spray bar, and front edge is inside of water trough.

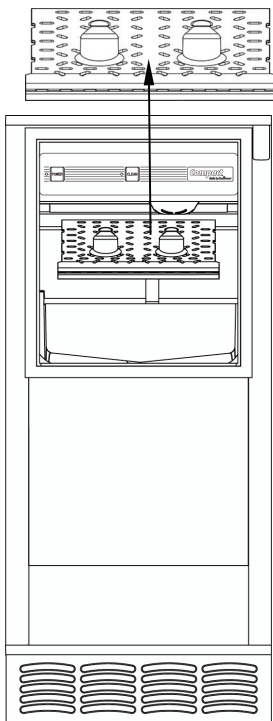

## SUMP DRAIN OVERFLOW TUBE

1. Remove clamp.
2. Pull down to remove overflow tube and tubing as an assembly. The sump trough water will drain into the bin.
3. Remove overflow tube from vinyl tubing by pulling.

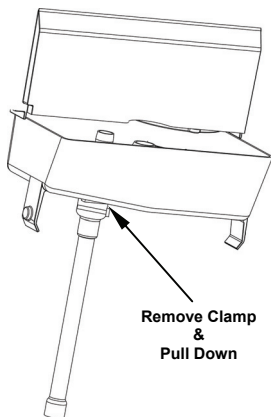

## WATER TROUGH

1. Depress tabs on right and left side of the water trough.
2. Allow front of water trough to drop as you pull forward to disengage the rear pins.

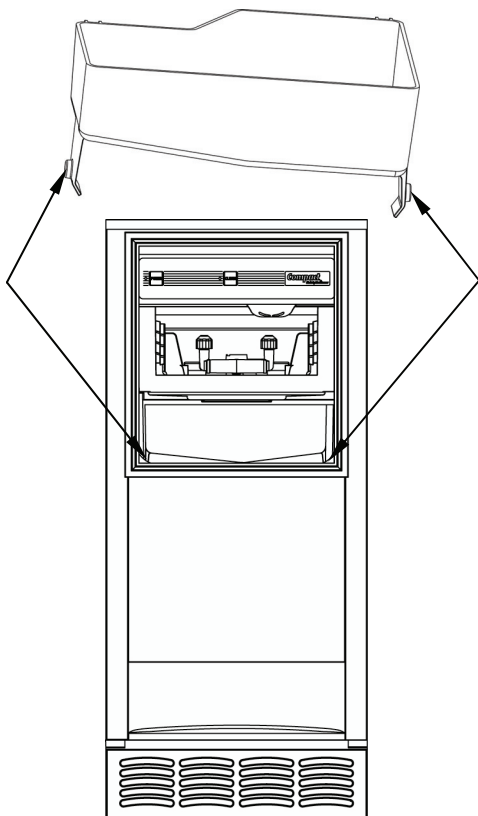

## SPRAY BAR, WATER PUMP AND HOSE



### WARNING

Disconnect the electric power to the ice machine at the electric service switch box and turn off the water supply before proceeding.

Remove spray bar clamp and spray bar.

1. Grasp pump and pull straight down until water pump disengages and electrical connector is visible.
2. Disconnect the electrical connector.
3. Remove the water pump from ice machine.
4. Remove clamp from hose to remove from pump.
5. Do not submerge the water pump motor in cleaner or sanitizer. If soaking is required, immerse pump to normal water level during the freeze.

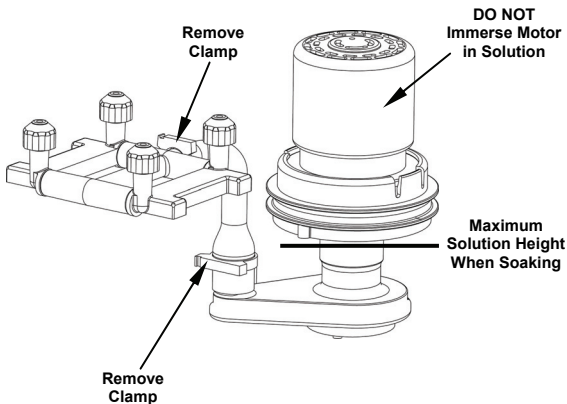

## SPRAY BAR DISASSEMBLY

The spray bar supplies water to the individual ice making cups. Water from the water pump sprays through the nozzles, located on the upper portion of the tubes.

1. Grasp one end of the spray bar, lift up and remove from seat formed in evaporator bucket.
2. Remove clamp on water inlet tubing by grasping both ears on clip and separating.
3. Apply food grade lubricant to ease re-assembly of spray bar components when necessary.
4. To re-install spray bar, position water inlet tubing on inlet ports, and squeeze clips until tight.
5. Reposition assembly on water trough seat. Nozzles and inserts can be removed for cleaning by unscrewing nozzles. Inserts are located inside the spray bar ports. The spray bar also disassembles for easy cleaning.

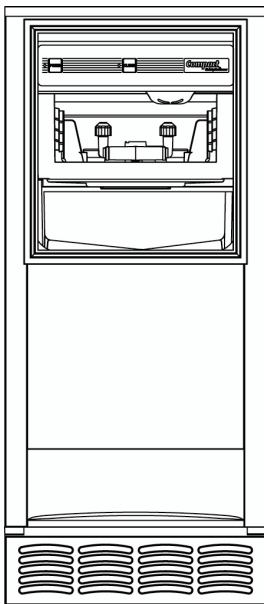
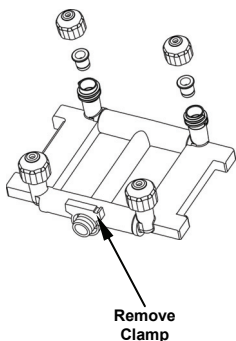

## REMOVAL FROM SERVICE/LONG TERM STORAGE/WINTERIZATION

### GENERAL

Special precautions must be taken if the ice machine is to be removed from service for an extended period of time or exposed to ambient temperatures of 32°F (0°C) or below.



### CAUTION

If water is allowed to remain in the ice machine in freezing temperatures, severe damage to some components could result. Damage of this nature is not covered by the warranty.

Follow the applicable procedure below.

### SELF-CONTAINED AIR-COOLED ICE MACHINES

1. Perform a cleaning and sanitizing procedure to prevent mildew growth.
2. Disconnect the electric power at the circuit breaker or the electric service switch.
3. Turn off the water supply.
4. Remove the water from the water trough.
5. Disconnect and drain the incoming ice-making water line at the rear of the ice machine.
6. Blow compressed air in both the incoming water and the drain openings in the rear of the ice machine until no more water comes out of the inlet water lines or the drain.
7. Make sure water is not trapped in any of the water lines, drain lines, distribution tubes, etc.
8. Block the door partially open to provide air exchange and prevent mildew growth.

# ICE MAKING SEQUENCE OF OPERATION

Depending on ambient conditions and cold water supply temperature, the ice making process will take approximately 30 minutes.

1. **Initial Start-Up or Start-Up After Automatic Shut-Off — Water Fill**

Before the compressor starts, the water inlet valve will energize to purge old water from the system for about 3 minutes.

2. **Refrigeration System Start-Up**

The compressor starts after the Water Fill cycle and remains on throughout the Freeze and Harvest cycles. The condenser fan motor starts and runs throughout the Freeze cycle.

3. **Freeze**

The water pump sprays water into the inverted cups. The water freezes layer by layer, until an ice cube forms in each cup. The control system will adjust the length of the Freeze cycle to conditions.

4. **Harvest**

The water pump shuts off and the water inlet valve starts up to assist harvest and refill the water sump. The evaporator is warmed, allowing the cubes to release from the evaporator and drop into the storage bin. The control system will adjust the length of the Harvest cycle to conditions and regulate whether the condenser fan will run.

At the end of the Harvest cycle, the ice machine will start another Freeze cycle (Step 3).

5. **Automatic Shut-Off**

The level of ice in the storage bin controls the ice machine shut-off. When the bin is full, ice will contact the bin thermostat bulb holder. The bin thermostat bulb cools, which stops the ice machine. The ice machine remains off until ice no longer contacts the bin thermostat bulb holder and the thermostat bulb warms up. The increase in temperature will restart the ice machine (step 1).

## ENERGIZED PARTS CHART SELF-CONTAINED ICE MACHINES

ICE MAKING SEQUENCE OF OPERATION	Control Board Relays			Length of "ON" Time
	1 Compressor	2 Hot Gas Valve Water Fill Valve	3 Water Pump Fan Motor	
Initial Start-Up	off	on	off	175 seconds
1. Water Fill 2. Refrigeration System Startup	on	on	on	5 seconds
3. Freeze Cycle	on	off	on	Automatically determined
4. Harvest Cycle	on	on	off	Automatically determined
5. Auto-Shut-Off	off	off	off	Until bin thermostat re-closes



# TROUBLESHOOTING

## DIAGNOSING AN ICE MACHINE THAT WILL NOT RUN



### WARNING

High (line) voltage is applied to the control board (terminals #20 and #21) at all times. Removing control board fuse or moving the toggle switch to OFF will not remove the power supplied to the control board.

1. Verify primary voltage is supplied to ice machine.
2. Verify that the fuse or circuit breaker is closed and the ice machine is plugged into a receptacle.
3. Verify control board fuse is OK.
4. Verify the transformer is supplying power to the control board.
  - If the interior light functions or the red control board light is energized the transformer is OK.
  - If the transformer is supplying power to the control board and the red control board light will not energize, replace the control board.

5. Verify the "Power" switch functions properly.
  - If the red control board light is energized and depressing the "Power" switch does not energize the green "Power" light, check the interconnecting wire, then replace the interface board.
6. Verify the bin thermostat functions properly.
  - The green "Power" light will be energized and the ice machine will function in the "Clean" cycle with the bin thermostat is open.
7. Check control board light to see if ice machine shutdown on over temperature limit (control board light will flash rapidly).
8. Replace the control board.
  - Be sure Steps 1-6 were followed thoroughly. Intermittent problems are not usually related to the control board.

## **ICE MACHINE WILL NOT HARVEST**

1. Verify cubes are present in evaporator and freeze time exceeds freeze chart cycle time.
  - Initial freeze cycle after resetting at toggle switch will be 5 minutes longer than chart time (refer to Sequence of Operation).
  - Verify control board is not set for additional freeze time to fill out the ice cubes, see cube weight adjustment.
2. Observe control board light:
  - Steady light indicates thermistor operation is normal.
  - Slow flash indicates a thermistor problem (open or disconnected). Verify liquid line thermistor is connected to control board, securely attached to liquid line and insulated. Refer to resistance chart and Ohm thermistor.
  - Rapid flash indicates liquid line temperature exceeded 170°F (refer to discharge pressure high checklist). If unable to determine cause, refer to resistance chart and Ohm thermistor.
3. Reset ice machine.
  - Wait freeze cycle time plus an addition 5 minutes (refer to Sequence of Operation).
4. Verify the water inlet valve is energized during the entire harvest cycle and water flow is normal.
  - Although the hot gas valve is energized, the ice machine will not consistently harvest if the water inlet valve does not energize or has low water flow.
5. Check for power at the hot gas valve
  - Power is present - replace coil/valve.
  - No power at hot gas valve - check for power at circuit board connector, replace control board if no power is present.

## **ICE QUALITY IS POOR – CUBES ARE SHALLOW, INCOMPLETE OR WHITE**

### **Problem**

- Cause

### **Ice machine is dirty**

- Clean and sanitize the ice machine

### **Water filtration is poor**

- Replace the filter

### **Water softener is working improperly (if applicable)**

- Repair the water softener

### **Poor incoming water quality**

- Contact a qualified company to test the quality of the incoming water and make appropriate filter recommendations

### **Water escaping from sump during freeze cycle**

- Check standpipe and drain
- Check for water tracking out of water circuit

## **FREEZE CYCLE IS LONG, LOW ICE PRODUCTION**

### **Problem**

- Cause

### **Water temperature is too high**

- Connect to a cold water supply, verify check valves in faucets and other equipment are functioning correctly

### **Dirty Condenser**

- Clean condenser

### **High air temperature entering condenser**

- Air temperature must not exceed 120°F (39°C)

### **Water inlet valve filter screen is dirty**

- Remove the water inlet valve and clean the filter screen

### **Water inlet valve stuck open or leaking**

- Turn off ice machine, if water continues to enter ice machine, verify water pressure is ok then replace water inlet valve

### **Water inlet valve is not working**

- Water inlet valve must be replaced

### **Refrigeration problem**

- Refer to refrigeration diagnostics

### **Water escaping from sump during freeze cycle**

- Check standpipe and drain
- Check for water tracking out of water circuit

## **ICE MACHINE RUNS & NO ICE IS PRODUCED**

### **Problem**

- Cause

### **No water to ice machine**

- Correct water supply

### **Incorrect incoming water pressure**

- Water pressure must be 20-80 psi (1.4-5.5 bar)

### **Spray nozzle is blocked with mineral buildup**

- Clean and sanitize the ice machine

### **Ambient temperature is too high or low**

- Ambient temperature must be between 50°F and 110°F (10°C and 43°C)

### **Thermistor Disconnected or Open**

- Refer to thermistor diagnostics

## ANALYZING DISCHARGE PRESSURE

1. Determine the ice machine operating conditions:  
Air temp. entering condenser \_\_\_\_\_  
Air temp. around ice machine \_\_\_\_\_  
Water temp. entering sump trough \_\_\_\_\_
2. Refer to Cycle Times/24 Hour Ice Production/Refrigeration Pressure Chart for ice machine being checked.

Use the operating conditions determined in Step 1 to find the published normal discharge pressures.

Freeze Cycle \_\_\_\_\_

Harvest Cycle \_\_\_\_\_

3. Perform an actual discharge pressure check.

	Freeze Cycle PSIG	Harvest Cycle PSIG
Beginning of Cycle	_____	_____
Middle of Cycle	_____	_____
End of Cycle	_____	_____

4. Compare the actual discharge pressure (Step 3) with the published discharge pressure (Step 2).

The discharge pressure is normal when the actual pressure falls within the published pressure range for the ice machine's operating conditions. It is normal for the discharge pressure to be higher at the beginning of the freeze cycle (when load is greatest), then drop through out the freeze cycle.

## **DISCHARGE PRESSURE HIGH CHECKLIST**

### **Problem**

- Cause

### **Improper Installation**

- Refer to "Installation/Visual Inspection Checklist"

### **Restricted Condenser Air Flow**

- High inlet air temperature
- Condenser discharge air re-circulation
- Dirty condenser fins
- Defective fan motor

### **Improper Refrigerant Charge**

- Overcharged
- Non-condensable in system
- Wrong type of refrigerant

### **Other**

- Non-Manitowoc components in system
- High side refrigerant lines/component restricted (before mid-condenser)

## **FREEZE CYCLE DISCHARGE PRESSURE LOW CHECKLIST**

### **Problem**

- Cause

### **Improper Installation**

- Refer to "Installation/Visual Inspection Checklist"

### **Improper Refrigerant Charge**

- Undercharged
- Wrong type of refrigerant

### **Other**

- Non-Manitowoc components in system
- High side refrigerant lines/component restricted (after condenser)
- Ambient temperature too low

NOTE: Do not limit your diagnosis to only the items listed in the checklists.



## **ANALYZING SUCTION PRESSURE**

The suction pressure gradually drops throughout the freeze cycle. The actual suction pressure (and drop rate) changes as the air and water temperature entering the ice machine changes. These variables also determine the freeze cycle times.

To analyze and identify the proper suction pressure drop throughout the freeze cycle, compare the published suction pressure to the published freeze cycle time.

**NOTE:** Analyze discharge pressure before analyzing suction pressure. High or low discharge pressure may be causing high or low suction pressure.

## PROCEDURE

Step	
1. Determine the ice machine operating conditions.	Air temp. entering condenser: 90°F/32.2°C Air temp. around ice machine: 80°F/26.7°C Water temp. entering water fill valve: 70°F/21.1°C
2A. Refer to "Cycle Time" and "Operating Pressure" charts for ice machine model being checked. Using operating conditions from Step 1, determine published freeze cycle time and published freeze cycle suction pressure.	<p style="text-align: center;"><u>19.1 - 21.7 minutes</u></p> Published freeze cycle time:  <p style="text-align: center;"><u>20-3 PSIG</u></p> Published freeze cycle suction pressure:
	<b>Published Freeze Cycle Time (minutes)</b>
2B. Compare the published freeze cycle time and published freeze cycle suction pressure. Develop a chart.	
	<p style="text-align: center;"><b>Published Freeze Cycle Suction Pressure (psig)</b></p> In the example, the proper suction Pressure should be approximately 16 PSIG at 5 minutes; 12 PSIG at 10 Minutes; etc.
3. Perform an actual suction pressure check at the beginning, middle and end of the freeze cycle. Note the times at which the readings are taken.	Manifold gauges were connected to the example ice machine and suction pressure readings taken as follows: PSIG Beginning of Freeze cycle: 30 (at 1 min.) Middle of freeze cycle: 22 (at 10 min.) End of freeze cycle: 8 (at 20 min.)
4. Compare the actual freeze cycle suction pressure (Step 3) to the published freeze cycle time and pressure comparison (Step 2B). Determine if the suction pressure is high, low or acceptable.	In this example, the suction pressure is considered high throughout the freeze cycle. It should have been: Approximately 20 PSIG (at 1 minute) – not 30 Approximately 12 PSIG (at 10 minutes) – not 22 Approximately – 3 PSIG (at 20 minutes) – not 8

## SUCTION PRESSURE HIGH CHECKLIST

### **Problem**

- Cause

### **Improper Installation**

- Refer to "Installation/Visual Inspection Checklist"

### **Discharge Pressure**

- Discharge pressure is too high, and is affecting suction pressure, refer to "Freeze Cycle Discharge Pressure High Checklist"

### **Improper Refrigerant Charge**

- Overcharged
- Wrong type of refrigerant
- Non Condensable in system

### **Other**

- Non-Manitowoc components in system
- Hot gas valve leaking
- Defective compressor
- Water inlet valve leaking

## SUCTION PRESSURE LOW CHECKLIST

### **Problem**

- Cause

### **Improper Installation**

- Refer to "Installation/Visual Inspection Checklist"

### **Discharge Pressure**

- Discharge pressure is too low, and is affecting suction pressure, refer to "Freeze Cycle Discharge Pressure Low Checklist"

### **Improper Refrigerant Charge**

- Undercharged
- Wrong type of refrigerant

### **Other**

- Non-Manitowoc components in system
- Improper water supply over evaporator refer to "Water System Checklist"
- Loss of heat transfer from tubing on back side of evaporator
- Restricted/plugged liquid line drier
- Restricted/plugged tubing in suction side of refrigeration system

NOTE: Do not limit your diagnosis to only the items listed in the checklists.

## **HOT GAS VALVE**

### **General**

The hot gas valve is an electrically operated valve that opens when energized, and closes when de-energized.

### **Normal Operation**

The valve is de-energized (closed) during the freeze cycle and energized (open) during the harvest cycle. The valve is positioned between the receiver and the evaporator and performs two functions:

1. Prevents refrigerant from entering the evaporator during the freeze cycle.

The hot gas valve is not used during the freeze cycle. The hot gas valve is de-energized (closed) preventing refrigerant flow from the receiver into the evaporator.

2. Allows refrigerant vapor to enter the evaporator in the harvest cycle.

During the harvest cycle, the hot gas valve is energized (open) allowing refrigerant gas from the discharge line of the compressor to flow into the evaporator. The heat is absorbed by the evaporator and allows release of the ice slab.

Exact pressures vary according to ambient temperature. Harvest pressures can be found in the "Cycle Time/24 Hour Ice Production/ Refrigerant Pressure Charts in this book.

## HOT GAS VALVE ANALYSIS

The valve can fail in two positions:

- Valve will not open in the harvest cycle.
- Valve remains open during the freeze cycle.

### **Valve will not open in the harvest cycle**

Although the circuit board has initiated a harvest cycle, the evaporator temperature remains unchanged from the freeze cycle.

### **Valve remains open in the freeze cycle:**

Symptoms are dependent on the amount of leakage in the freeze cycle. A small amount of leakage will cause increased freeze cycle times. A large amount of leakage will result in no ice produced.

Use the following procedure and table to help determine if a hot gas valve is remaining partially open during the freeze cycle.

1. Wait five minutes into the freeze cycle.
1. Feel the inlet of the hot gas valve(s).

### **IMPORTANT**

Feeling the hot gas valve outlet or across the hot gas valve itself will not work for this comparison. The hot gas valve outlet is on the suction side (cool refrigerant). It may be cool enough to touch even if the valve is leaking.



### **WARNING**

The inlet of the hot gas valve and the compressor discharge line could be hot enough to burn your hand. Just touch them momentarily

2. Feel the compressor discharge line.
3. Compare the temperature of the inlet of the hot gas valves to the temperature of the compressor discharge line.

## EXAMPLES OF HOT GAS VALVE INLET/COMPRESSOR DISCHARGE LINE TEMPERATURE COMPARISON

Findings	Comments
<p>The inlet of the hot gas valve is cool enough to touch and the compressor discharge line is hot.</p>	<p>This is normal as the discharge line should always be too hot to touch and the hot gas valve inlet, although too hot to touch during harvest, should be cool enough to touch after 5 minutes into the freeze cycle.</p>
<p>The inlet of the hot gas valve is hot and approaches the temperature of a hot compressor discharge line.</p>	<p>This is an indication something is wrong, as the hot gas valve inlet did not cool down during the freeze cycle. If the compressor dome is also entirely hot, the problem is not a hot gas valve leaking, but rather something causing the compressor (and the entire ice machine) to get hot.</p>
<p>Both the inlet of the hot gas valve and the compressor discharge line are cool enough to touch.</p>	<p>This is an indication something is wrong, causing the compressor discharge line to be cool to the touch. This is not caused by a hot gas valve leaking.</p>

## **BIN THERMOSTAT**

### **Function**

The bin thermostat stops the ice machine when the bin is full.

The level of ice in the ice storage bin controls the ice machine shut-off. When the bin is full, ice cubes contact the bin thermostat bulb holder, which cools down and opens the bin thermostat to stop the ice machine. The ice machine remains off until enough ice has been removed from the bin. This causes the thermostat bulb holder to warm and closes the bin thermostat, restarting the ice machine.

### **Specifications**

<b>Control</b>	<b>Setting</b>
Bin Thermostat	Cut in: 34°F (4.5°C) Cut out: 33.8°F (1.0°C)

## Check Procedure



### WARNING

High (line) voltage is applied to the control board (terminals #20 and #21) at all times. Removing the control board fuse or depressing the power button will not remove the power supplied to the control board.



### WARNING

Disconnect electrical power to the entire ice machine before proceeding.

1. Verify the capillary tube is inserted correctly in the bulb holder (17" 43 cm).
2. Remove the 2 bottom front panels to access the bin thermostat.
3. Disconnect wires #45 and #46 from the bin thermostat or control board and check the resistance across the bin thermostat terminals.

No Ice on Bulb	Ice on Bulb	Result
Closed (O)	Open (OL)	Thermostat good
Open (OL)	Closed (O)	Replace thermostat

**Note:** After covering/uncovering the bulb holder with ice, wait at least three minutes to allow the thermostat to react. (Open/Close)



## ICE PRODUCTION CHECK

The amount of ice a machine produces directly relates to the operating water and air temperatures. This means an ice machine with a 70°F (21.2°C) ambient temperature and 50°F (10.0°C) water produces more ice than the same ice machine with 90°F (32.2°C) ambient and 70°F (21.2°C) water.

- Determine the ice machine operating conditions:  
Air temp entering condenser: \_\_\_\_\_°  
Air temp around ice machine: \_\_\_\_\_°  
Water temp entering sump trough: \_\_\_\_\_°
- Refer to the appropriate 24-Hour Ice Production Chart. Use the operating conditions determined in Step 1 to find published 24 hr. ice production: \_\_\_\_\_  
Times are in minutes.  
Example: 1 min., 15 sec. converts to 1.25 min.  
(15 seconds ÷ 60 seconds = .25 minutes)  
Weights are in pounds.  
Example: 2 lb., 6 oz. converts to 2.375 lb.  
(6 oz. ÷ 16 oz. = .375 lb.)
- Perform an ice production check using the formula below.

1. _____	+	_____	=	_____
Freeze Time		Harvest Time		Total Cycle Time
2. <u>1440</u>	÷	_____	=	_____
Mins in 24 hrs		Total Cycle Time		Cycles Per Day
3. _____	x	_____	=	_____
Weight of One Harvest		Cycles Per Day		Actual 24 Hr Production

- Compare the results of Step 3 with Step 2. Ice production is normal when these numbers match closely. If they match closely, determine if:  
Another larger ice machine is required.  
Relocating the existing equipment to lower the load conditions is required.

## **ADJUSTING CUBE WEIGHT**

The cube weight can be increased from the factory setting by adjusting the finish time.

### **Additional finishing time check:**

Press and hold the power button for 5 seconds.

- Count the flashes on the Automatic Ice Making light. The light will flash once for each additional minute of freeze cycle time.

### **Adjusting Finishing Time**

Adjust in 1-minute increments and allow the ice machine to run several freeze/harvest cycles, and then inspect the ice cubes. If a heavier cube weight is desired add another minute of freeze time and repeat the process.

Press and hold the power button.

- Press and release the clean button once for each additional minute of freeze cycle time desired.

Five minutes is the maximum additional freeze time that can be added. Pressing the clean button 6 times will reset the finishing time to zero additional minutes.

## **LIQUID LINE THERMISTOR**

### **Function**

The liquid line thermistor senses the refrigeration system liquid line temperature. This is used in conjunction with the control board to determine the length of the freeze and harvest cycles.

### **Specifications**

10,000 Ohms  $\pm$  2% at 25°C (77°F)



### **CAUTION**

Use only Manitowoc thermistors.

### **Check Procedure**

Verify that the thermistor resistance is accurate and corresponding to the high and low temperature ranges.

1. Disconnect the thermistor at the control board. Connect the ohmmeter to the isolated thermistor wire leads.
2. Using a temperature meter capable of taking readings on curved copper lines, attach the temperature meter-sensing device to the liquid line next to the thermistor aluminum block.

### **IMPORTANT**

Do not simply "insert" the sensing device under the insulation. It must be attached to and reading the actual temperature of the copper liquid line.

3. With the ice machine running, verify that the temperature of the discharge line (step 2) corresponds to the thermistor resistance reading (step 1) as stated in the temperature/resistance chart.

## TEMPERATURE/RESISTANCE CHART

As the temperature rises at the thermistor block, the resistance drops.

### IMPORTANT

If the ohmmeter reads "OL," check the scale setting on the meter before assuming the thermistor is bad.

### SM50 Resistance Chart

Temperature of Thermistor		Resistance K Ohms (x 1000)
°C	°F	
15.6° - 21.1°	60° - 70°	15.31 - 11.88
21.1° - 26.7°	70° - 80°	11.88 - 9.29
26.7° - 32.2°	80° - 90°	9.29 - 7.33
32.2° - 37.8°	90° - 100°	7.33 - 5.82
37.8° - 43.3°	100° - 110°	5.82 - 4.66
43.3° - 48.9°	110° - 120°	4.66 - 3.75
48.9° - 54.4°	120° - 130°	3.75 - 3.05
54.4° - 60.0°	130° - 140°	3.05 - 2.49
60.0° - 65.6°	140° - 150°	2.49 - 2.04
65.6° - 71.1°	150° - 160°	2.04 - 1.68
71.1° - 76.7°	160° - 170°	1.68 - 1.40
76.7° - 82.2°	170° - 180°	1.40 - 1.17
82.2° - 87.8°	180° - 190°	1.17 - 0.98
87.8° - 93.3°	190° - 200°	0.98 - 0.82
93.3° - 98.9°	200° - 210°	0.82 - 0.70
100° (boiling water bath)	212°	0.73 - 0.62
104.4° - 110.0°	220° - 230°	0.59 - 0.51
110.0° - 115.6°	230° - 240°	0.51 - 0.43
115.6° - 121.1°	240° - 250°	0.43 - 0.37
121.1° - 126.7°	250° - 260°	0.37 - 0.33

## TOTAL SYSTEM REFRIGERATION CHARGE

### IMPORTANT

This information is for reference only. Refer to the ice machine serial number tag to verify the system charge. Serial plate information overrides information listed on this page.

<b>Model</b>	<b>Refrigerant Charge (grams)</b>	<b>Refrigerant Type</b>
CM50 Air Cooled	160	R-134A

# COMPONENT SPECIFICATIONS AND CHECK PROCEDURES

## MAIN FUSE

### Function

The control board fuse stops ice machine operation if electrical components fail causing high amp draw.

### Specifications

	Volt	Amp
CM50	250	10

### Check Procedure



#### WARNING

High (line) voltage is applied to the control board at all times. Removing the control board fuse or moving the toggle switch to OFF will not remove the power supplied to the control board.

1. If the bin switch light is on with the ice damper closed, the fuse is good.



#### WARNING

Disconnect electrical power to the entire ice machine before proceeding.

2. Remove the fuse. Check the resistance across the fuse with an ohmmeter.

Reading	Result
Open (OL)	Replace fuse
Closed (O)	Fuse is good

## **COMPRESSOR ELECTRICAL DIAGNOSTICS**

The compressor does not start or will trip repeatedly on overload.

### **CHECK RESISTANCE (OHM) VALUES**

NOTE: Compressor windings can have very low ohm values. Use a properly calibrated meter.

Perform the resistance test after the compressor cools. The compressor dome should be cool enough to touch (below 120°F/49°C) to assure that the overload is closed and the resistance readings will be accurate.

### **SINGLE PHASE COMPRESSORS**

1. Disconnect power from the condensing unit and remove the wires from the compressor terminals.
2. The resistance values between C and S and between C and R, when added together should equal the resistance value between S and R.
3. If the overload is open, there will be a resistance reading between S and R, and open readings between C and S and between C and R. Allow the compressor to cool, then check the readings again.

### **CHECK MOTOR WINDINGS TO GROUND**

Check continuity between all three terminals and the compressor shell or copper refrigeration line. Scrape metal surface to get good contact. If continuity is present, the compressor windings are grounded and the compressor should be replaced.

To determine if the Compressor is seized check the amp draw while the compressor is trying to start.

## **COMPRESSOR DRAWING LOCKED ROTOR**

The two likely causes of this are:

- Defective starting component
- Mechanically seized compressor

To determine which you have:

- Install high and low side gauges.
- Try to start the compressor.
- Watch the pressures closely.

If the pressures do not move, the compressor is seized. Replace the compressor.

If the pressures move, the compressor is turning slowly and is not seized. Check the capacitors and relay.

## **COMPRESSOR DRAWING HIGH AMPS**

The continuous amperage draw on start-up should not be near the maximum fuse size indicated on the serial tag.

The wiring must be correctly sized to minimize voltage drop at compressor start-up. The voltage when the compressor is trying to start must be within  $\pm 10\%$  of the nameplate voltage.



## **DIAGNOSING START COMPONENTS:**

If the compressor attempts to start, or hums and trips the overload protector, check the start components before replacing the compressor.

### **CAPACITOR**

Visual evidence of capacitor failure can include a bulged terminal end or a ruptured membrane. Do not assume a capacitor is good if no visual evidence is present. A good test is to install a known good substitute capacitor. Use a capacitor tester when checking a suspect capacitor. Clip the bleed resistor off the capacitor terminals before testing.

### **RELAY**

The relay has a set of contacts that connect and disconnect the start capacitor from the compressor start winding. The contacts on the relay are normally open. The relay senses the voltage generated by the start winding and closes and then opens the contacts as the compressor motor starts. The contacts remain open until the compressor is de-energized.

## **CYCLE TIMES, 24 HR ICE PRODUCTION AND REFRIGERANT PRESSURE CHARTS**

These charts are used as guidelines to verify correct ice machine operation.

Accurate collection of data is essential to obtain the correct diagnosis.

- Refer to “OPERATIONAL ANALYSIS CHART” for the list of data that must be collected for refrigeration diagnostics. This list includes: before beginning service, ice production check, installation/visual inspection, water system checklist, ice formation pattern, safety limits, comparing evaporator inlet/outlet temperatures, hot gas valve analysis, discharge and suction pressure analysis.
- Ice production checks that are within 10% of the chart are considered normal. This is due to variances in water and air temperature. Actual temperatures will seldom match the chart exactly.
- Zero out manifold gauge set before obtaining pressure readings to avoid misdiagnosis.
- Discharge and suction pressure are highest at the beginning of the cycle. Suction pressure will drop throughout the cycle. Verify the pressures are within the range indicated.

**NOTE: THESE CHARACTERISTICS MAY VARY DEPENDING ON OPERATING CONDITIONS.**

**Cycle Times**

Freeze Time + Harvest Time = Cycle Time

AIR TEMP. ENTERING CONDENSER °F/°C	FREEZE TIME			HARVEST TIME
	WATER TEMPERATURE °F/°C			
	50/10.0	70/21.1	90/32.2	
70/21.1	15.6-17.8	15.3-17.4	15.6-17.8	1.0-3.5
80/26.7	16.6-18.9	17.0-19.4	17.4-19.8	
90/32.2	17.4-19.8	19.1-21.7	18.2-20.7	
100/37.8	19.2-22.1	19.8-22.7	22.4-25.4	
110/43.3	24.9-28.2	25.7-29.1	31.4-35.5	

Times in minutes

**24 Hour Ice Production**

AIR TEMP. ENTERING CONDENSER °F/°C	WATER TEMPERATURE °F/°C		
	50/10.0	70/21.1	90/32.2
70/21.1	53	54	53
80/26.7	50	49	48
90/32.2	48	44	46
100/37.8	40	39	38
110/43.3	35	34	28

Based on the average weight of 1 harvest cycle 0.63 – 0.71 lb.

Nominal Individual Cube Weight 0.70 ounces

Cubes Per Harvest Cycle 16

**Operating Pressures**

AIR TEMP. ENTERING CONDENSER °F/°C	FREEZE CYCLE		HARVEST CYCLE	
	DISCHARGE PRESSURE PSIG	SUCTION PRESSURE PSIG	DISCHARGE PRESSURE PSIG	SUCTION PRESSURE PSIG
50/10.0	125-70	18-0	50-75	20-55
70/21.1	135-95	18-0	65-85	35-60
80/26.7	165-115	19-2	75-100	40-70
90/32.2	195-135	20-3	85-120	40-70
100/37.8	235-165	24-5	100-135	50-80
110/43.3	255-185	28-7	110-155	50-90

Suction pressure drops gradually throughout the freeze cycle

# **REFRIGERANT DEFINITIONS**

## **Recover**

To remove refrigerant, in any condition, from a system and store it in an external container, without necessarily testing or processing it in any way.

## **Recycle**

To clean refrigerant for re-use by oil separation and single or multiple passes through devices, such as replaceable core filter-driers, which reduce moisture, acidity and particulate matter. This term usually applies to procedures implemented at the field job site or at a local service shop.

## **Reclaim**

To reprocess refrigerant to new product specifications (see below) by means which may include distillation. A chemical analysis of the refrigerant is required after processing to be sure that product specifications are met. This term usually implies the use of processes and procedures available only at a reprocessing or manufacturing facility.

Chemical analysis is the key requirement in this definition. Regardless of the purity levels reached by a reprocessing method, refrigerant is not considered "reclaimed" unless it has been chemically analyzed and meets ARI Standard 700 (latest edition).

## **New Product Specifications**

This means ARI Standard 700 (latest edition). Chemical analysis is required to assure that this standard is met.

## **REFRIGERANT RE-USE POLICY**

Manitowoc recognizes and supports the need for proper handling, re-use, and disposal of, CFC and HCFC refrigerants. Manitowoc service procedures require recapturing refrigerants, not venting them to the atmosphere.

It is not necessary, in or out of warranty, to reduce or compromise the quality and reliability of your customers' products to achieve this.

### **IMPORTANT**

Manitowoc Ice, Inc. assumes no responsibility for use of contaminated refrigerant. Damage resulting from the use of contaminated, recovered, or recycled refrigerant is the sole responsibility of the servicing company.

Manitowoc approves the use of:

1. New Refrigerant
  - Must be of original nameplate type.
2. Reclaimed Refrigerant
  - Must be of original nameplate type.
  - Must meet ARI Standard 700 (latest edition) specifications.
3. Recovered or Recycled Refrigerant
  - Must be recovered or recycled in accordance with current local, state and federal laws.
  - Must be recovered from and re-used in the same Manitowoc product. Re-use of recovered or recycled refrigerant from other products is not approved.
  - Recycling equipment must be certified to ARI Standard 740 (latest edition) and be maintained to consistently meet this standard.

4. Recovered refrigerant must come from a “contaminant-free” system. To decide whether the system is contaminant free, consider:
  - Type(s) of previous failure(s)
  - Whether the system was cleaned, evacuated and recharged properly following failure(s)
  - Whether the system has been contaminated by this failure
  - Compressor motor burnouts and improper past service prevent refrigerant re-use.
  - Refer to “System Contamination Cleanup” to test for contamination.
  
5. “Substitute” or “Alternative” Refrigerant
  - Must use only Manitowoc-approved alternative refrigerants.
  - Must follow Manitowoc-published conversion procedures.

## Refrigerant Recovery/Evacuation/Charging

Do not purge refrigerant to the atmosphere. Capture refrigerant using recovery equipment. Follow the manufacturer's recommendations.

Install and uninstall your manifold gauge set correctly to prevent refrigerant loss.

### IMPORTANT

Manitowoc Ice, Inc. assumes no responsibility for the use of contaminated refrigerant. Damage resulting from the use of contaminated refrigerant is the sole responsibility of the servicing company.

### IMPORTANT

Replace the liquid line drier before evacuating and recharging. Use only a Manitowoc (O.E.M.) liquid line filter drier to prevent voiding the warranty.

### Connections

- Suction side of the compressor through the suction access fitting.
- Discharge side of the compressor through the discharge access fitting.

### IMPORTANT

Purge system with nitrogen while brazing to prevent build up of copper oxide in the refrigeration system.

## **IMPORTANT**

Manifold gauges must be removed properly to ensure that no refrigerant contamination or loss occurs. A quick disconnect is required for the high side connection.

### **Recovery/Evacuation**

1. Place the toggle switch in the OFF position.
2. Install manifold gauges, charging scale, and recovery unit or two-stage vacuum pump.
3. Open the high and low side valves on manifold gauges.
4. Perform recovery or evacuation:
  - A. Recovery: Operate the recovery unit as directed by the manufacturer's instructions.
  - B. Perform a nitrogen pressure test to verify leaks are not present.
  - C. Evacuation prior to recharging: Pull the system down to 500 microns.

**NOTE:** Check access fittings for leaks with an electronic leak detector after charging the ice machine.



## Charging Procedures

### **IMPORTANT**

The charge is critical on all Manitowoc ice machines. Use a scale to ensure the proper charge is installed. A quick disconnect is required for the high side connection

1. Be sure the toggle switch is in the OFF position.
2. Close the vacuum pump valve and the low side manifold gauge valve.
3. Open the high side manifold gauge valve.
4. Using a digital scale add the proper refrigerant charge (shown on nameplate) through the high side.
5. Close/isolate the refrigerant cylinder.
6. Let the system "settle" for 2 to 3 minutes.
7. Place the toggle switch in the ICE position.
8. Close the high side on the manifold gauge set.

NOTE: Manifold gauges must be removed properly to ensure that no refrigerant contamination or loss occurs. A quick disconnect is required for the high side connection.

9. Make sure that all refrigerant in the charging hose is drawn into the ice machine before disconnecting the manifold gauge set.
  - A. Drain the water from the sump trough.
  - B. Run the ice machine in the freeze cycle for 5 minutes.
  - C. Remove the high side hose with the quick disconnect.
  - D. Open the high and low side valves on the manifold gauge set. Any refrigerant in the lines will be pulled into the low side of the system.
  - E. Allow the suction pressure to reach 0 psig while the ice machine is in the freeze cycle.
  - F. Remove the low side hose.

## **SYSTEM CONTAMINATION CLEANUP**

### **GENERAL**

This section describes the basic requirements for restoring contaminated systems to reliable service.

#### **IMPORTANT**

Manitowoc Ice, Inc. assumes no responsibility for the use of contaminated refrigerant. Damage resulting from the use of contaminated refrigerant is the sole responsibility of the servicing company.

#### **Determining Severity Of Contamination**

System contamination is generally caused by either moisture or residue from compressor burnout entering the refrigeration system.

Inspection of the refrigerant usually provides the first indication of system contamination. Obvious moisture or an acrid odor in the refrigerant indicates contamination.

If either condition is found, or if contamination is suspected, use a Total Test Kit from Totaline or a similar diagnostic tool. These devices sample refrigerant, eliminating the need to take an oil sample. Follow the manufacturer's directions.

If a refrigerant test kit indicates harmful levels of contamination, or if a test kit is not available, inspect the compressor oil.

1. Remove the refrigerant charge from the ice machine.
2. Remove the compressor from the system.
3. Check the odor and appearance of the oil.
4. Inspect open suction and discharge lines at the compressor for burnout deposits.
5. If no signs of contamination are present, perform an acid oil test to determine the type of cleanup required.

<b>Contamination/Cleanup Chart</b>	
<b>Symptoms/Findings</b>	<b>Required Cleanup Procedure</b>
No symptoms or suspicion of contamination	Normal evacuation/recharging procedure
Moisture/Air Contamination symptoms Refrigeration system open to atmosphere for longer than 15 minutes Refrigeration test kit and/or acid oil test shows contamination No burnout deposits in open compressor lines	Mild contamination cleanup procedure
Mild Compressor Burnout symptoms Oil appears clean but smells acid Refrigeration test kit or acid oil test shows harmful acid content No burnout deposits in open compressor lines	Mild contamination cleanup procedure
Severe Compressor Burnout symptoms Oil is discolored, acidic, and smells acid Burnout deposits found in the compressor, lines, and other components	Severe contamination cleanup procedure

## MILD SYSTEM CONTAMINATION CLEANUP

### Procedure

1. Replace any failed components.
2. If the compressor is good, change the oil.
3. Replace the liquid line drier.

NOTE: If the contamination is from moisture, use heat lamps during evacuation. Position them at the compressor, condenser and evaporator prior to evacuation. Do not position heat lamps too close to plastic components, or they may melt or warp.

### IMPORTANT

Dry nitrogen is recommended for this procedure. This will prevent CFC release.

3. Follow the normal evacuation procedure, except replace the evacuation step with the following:
  - a) Pull vacuum to 1000 microns. Break the vacuum with dry nitrogen and sweep the system. Pressurize to a minimum of 5 psig.
  - b) Pull vacuum to 500 microns. Break the vacuum with dry nitrogen and sweep the system. Pressurize to a minimum of 5 psig.
  - c) Change the vacuum pump oil.
  - d) Pull vacuum to 500 microns.

NOTE: You may perform a pressure test as a preliminary leak check. You should use an electronic leak detector after system charging to be sure there are no leaks.

4. Charge the system with the proper refrigerant to the nameplate charge.
5. Operate the ice machine.

## **SEVERE SYSTEM CONTAMINATION CLEANUP PROCEDURE**

1. Remove the refrigerant charge.
2. Remove the compressor.
3. Wipe away any burnout deposits from suction and discharge lines at compressor.
4. Sweep through the open system with dry nitrogen.

### **IMPORTANT**

Refrigerant sweeps are not recommended, as they release CFC's into the atmosphere.

5. Install a new compressor and new start components.
6. Install suction line filter-drier in front of compressor.
7. Install a new liquid line drier.
8. Follow the normal evacuation procedure, except replace the evacuation step with the following:

### **IMPORTANT**

Dry nitrogen is recommended for this procedure. This will prevent CFC release.

- e) Pull vacuum to 1000 microns. Break the vacuum with dry nitrogen and sweep the system. Pressurize to a minimum of 5 psig.
- f) Change the vacuum pump oil.
- g) Pull vacuum to 500 microns. Break the vacuum with dry nitrogen and sweep the system. Pressurize to a minimum of 5 psig.
- h) Change the vacuum pump oil.
- i) Pull vacuum to 500 microns. Run the vacuum pump for 1 hour additional hour.

*Continued next page*

9. Charge the system with the proper refrigerant to the nameplate charge.
10. Operate the ice machine for one hour. Then, check the pressure drop across the suction line filter-drier.
  - a) If the pressure drop is less than 2 psig, the filter-drier should be adequate for complete cleanup.
  - b) If the pressure drop exceeds 2 psig, change the suction line filter-drier and the liquid line drier. Repeat until the pressure drop is acceptable.
11. Operate the ice machine for 48-72 hours. Replace the suction line and liquid line drier if necessary.
12. Follow normal evacuation procedures.

## **REPLACING PRESSURE CONTROLS WITHOUT REMOVING REFRIGERANT CHARGE**

This procedure reduces repair time and cost. Use it when any of the following components require replacement, and the refrigeration system is operational and leak-free.

- Fan cycle control
- High pressure cut-out control
- High side access valve
- Low side access valve

### **IMPORTANT**

This is a required in-warranty repair procedure.

1. Disconnect power to the ice machine.
2. Follow all manufacturers' instructions supplied with the pinch-off tool. Position the pinch-off tool around the tubing as far from the pressure control as feasible. (See the figure on next page.) Clamp down on the tubing until the pinch-off is complete.



### **WARNING**

Do not unsolder a defective component. Cut it out of the system. Do not remove the pinch-off tool until the new component is securely in place.

3. Cut the tubing of the defective component with a small tubing cutter.
4. Solder the replacement component in place. Allow the solder joint to cool.
5. Remove the pinch-off tool.
6. Re-round the tubing. Position the flattened tubing in the proper hole in the pinch off tool. Tighten the wing nuts until the block is tight and the tubing is rounded.

**NOTE:** The pressure controls will operate normally once the tubing is re-rounded. Tubing may not re-round 100%.



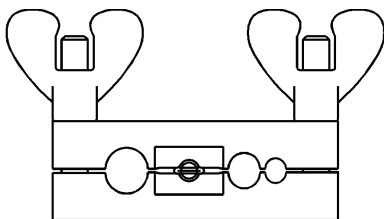

FIG. A - "PINCHING OFF" TUBING

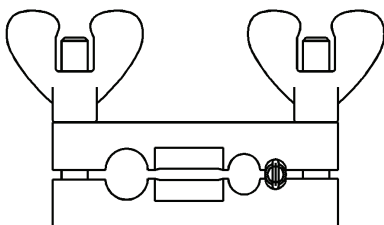

FIG. B - RE-ROUNDING TUBING

SV1406

### Using Pinch Off Tool

## BRAZING PROCEDURES FOR DANFOSS SOLENOID VALVES

- Danfoss stainless steel solenoid valves require a slightly different brazing technique than brass-bodied valves.  
Copper clad stainless steel does not require as much flame contact as copper tubing.  
Apply heat to the copper tubing first then the solenoid socket.
  - 15% silver solder is recommended although silver bearing solder in the 5% to 55% range can be used.
1. Remove coil and verify direction of flow.

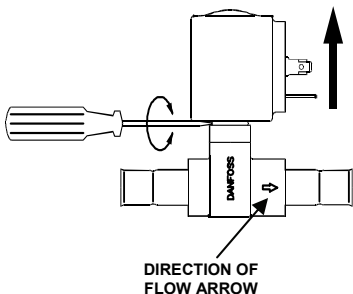

SV3069

2. Fit valve in place and align stem @ 12:00.

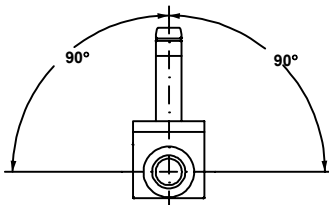

SV3070

3. Do not disassemble valve.

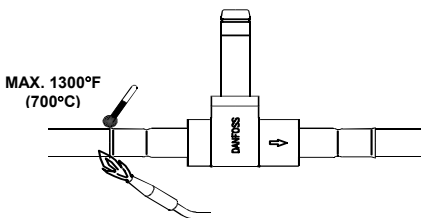

SV3071

4. Apply heat to copper tubing first and move flame toward valve socket.
  - A. Heat copper tubing for approximately 10 to 15 seconds then direct the heat to the solenoid socket
  - B. Heat the solenoid socket for 2 to 5 seconds and apply silver solder to joint.
  - C. Do not attempt to fill solenoid flange with solder. Solder will draw into socket.
5. Install new liquid line drier.
6. Leak check joints by pressurizing system with 150-  
psig nitrogen.
7. Evacuate and re-charge system to nameplate charge.
8. Reinstall coil (using a twisting motion) and attach wiring.

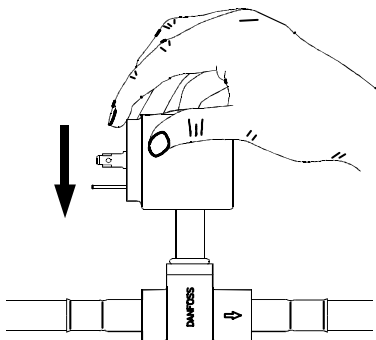

SV3073

## **FILTER-DRIERS**

### **Liquid Line Filter Drier**

The filter-drier used on Manitowoc ice machines are manufactured to Manitowoc specifications.

The difference between a Manitowoc drier and an off-the-shelf drier is in filtration. A Manitowoc drier has dirt-retaining filtration, with fiberglass filters on both the inlet and outlet ends. This is very important because ice machines have a back-flushing action that takes place during every harvest cycle.

A Manitowoc filter-drier has a very high moisture removal capability and a good acid removal capacity.

### **IMPORTANT**

The liquid line drier is covered as a warranty part. The liquid line drier must be replaced any time the system is opened for repair.

# CONTROL BOARD

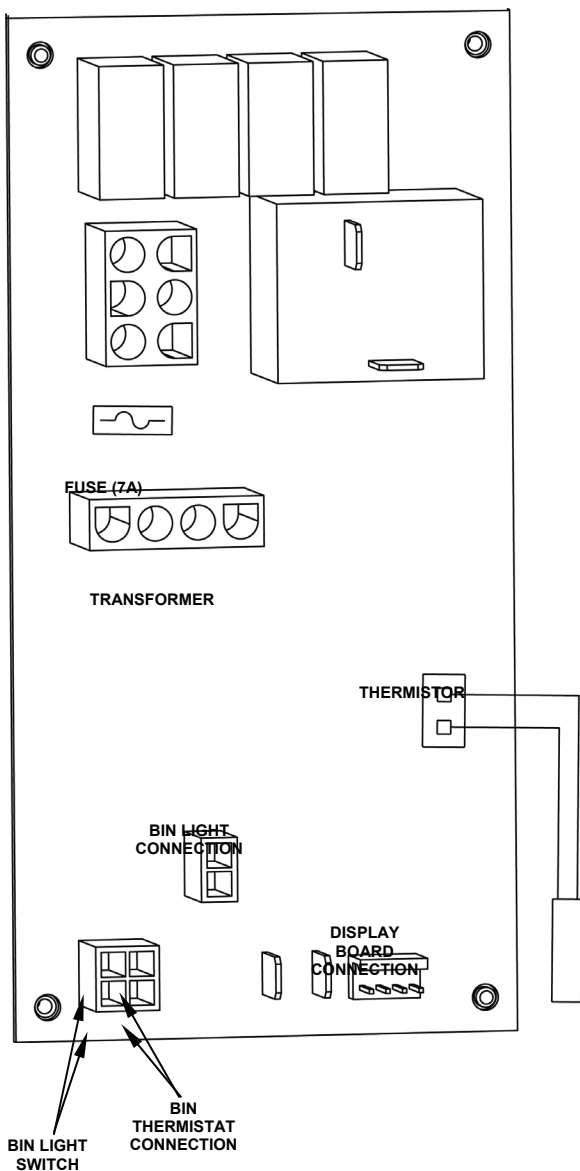

# WIRING DIAGRAMS

CAUTION: DISCONNECT POWER BEFORE  
WORKING ON ELECTRICAL CIRCUITRY  
DIAGRAM SHOWN DURING FREEZE CYCLE

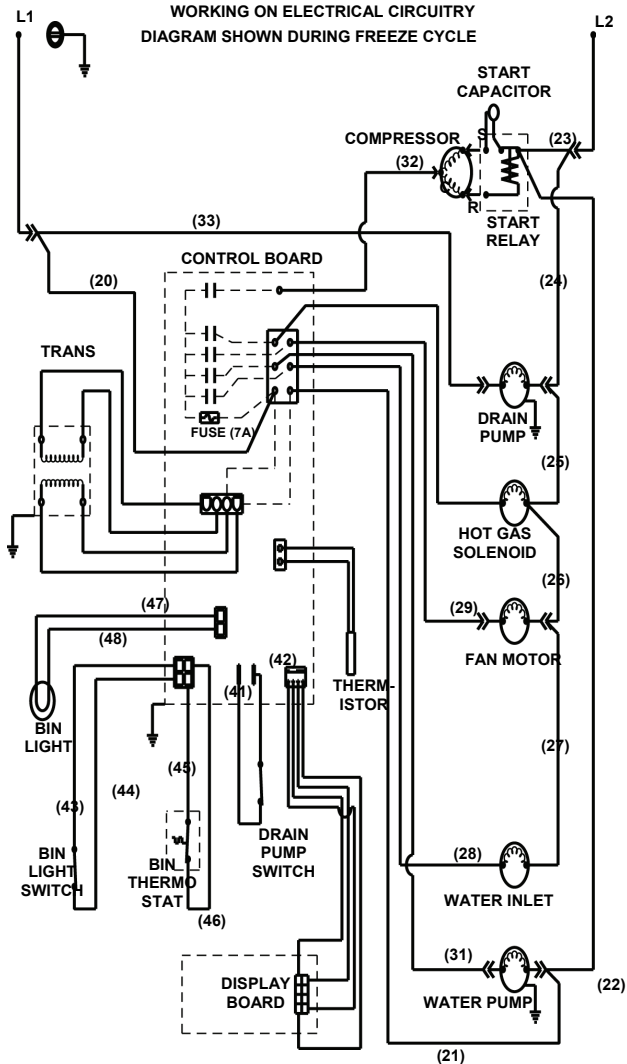

# TUBING SCHEMATIC

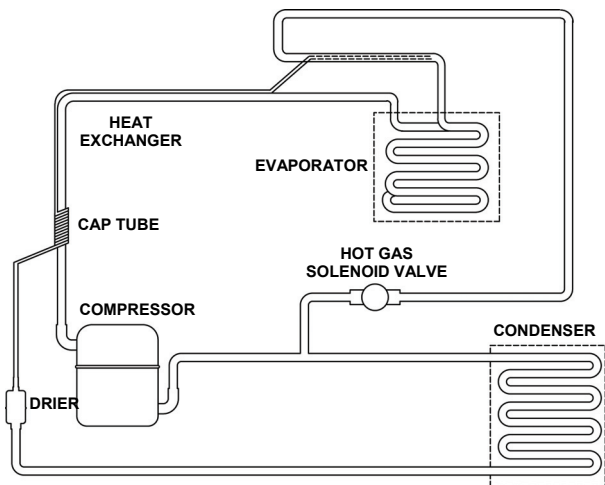

**Compact Ice by Manitowoc**  
**Manitowoc WI 54221-1720**  
**Phone: 1-800-235-9698**  
**Website – [www.compact-ice.com](http://www.compact-ice.com)**

**©2006 Manitowoc Ice, Inc.**



## Free Manuals Download Website

<http://myh66.com>

<http://usermanuals.us>

<http://www.somanuals.com>

<http://www.4manuals.cc>

<http://www.manual-lib.com>

<http://www.404manual.com>

<http://www.luxmanual.com>

<http://aubethermostatmanual.com>

Golf course search by state

<http://golfingnear.com>

Email search by domain

<http://emailbydomain.com>

Auto manuals search

<http://auto.somanuals.com>

TV manuals search

<http://tv.somanuals.com>