



MARTIN LOGAN®

THE GREAT AMERICAN SPEAKER COMPANY

MLT-2

HOME THEATER
SPEAKER SYSTEM

5.1 System

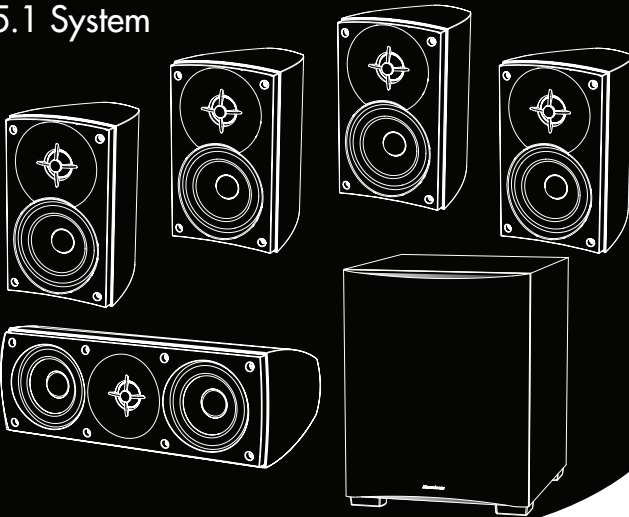

U S E R ' S M A N U A L

Thank you for choosing the MartinLogan MLT-2 5.1 Home Theater Speaker System. Our speakers are the product of countless hours of comprehensive research and development and will reward you with exceptional sound for many years.

To ensure proper installation please read this manual and follow all instructions. If you have further questions contact your Authorized MartinLogan Dealer or visit the Q&A page on our website at www.martinlogan.com.

UNPACKING YOUR SPEAKERS

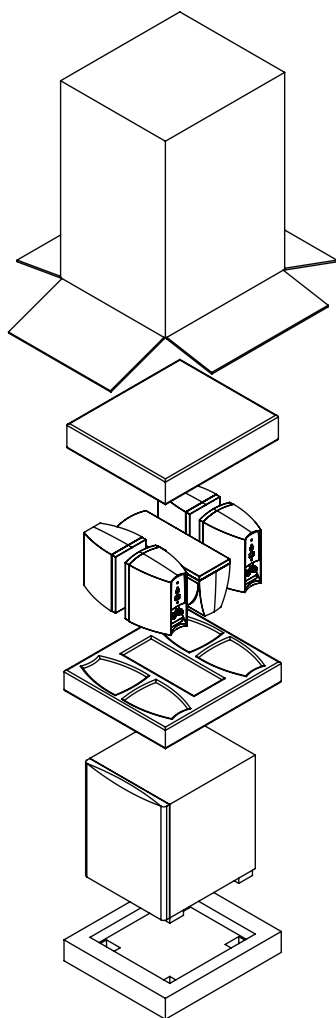

Serial Numbers:



Record your serial numbers here for easy reference. You will need this information when filling out your warranty registration. See page 14 for instructions on how to locate the serial numbers.

TABLE OF CONTENTS

Unpacking Your Speakers	1	Subwoofer Placement	9
Safety Precautions	2	Subwoofer Connection	10
Important Safety Instructions	3	Setting Subwoofer Controls	10
Your New Speakers	5	FAQ and Troubleshooting	12
Power Requirements	5	Serial Number & Service	14
How to Avoid Speaker Damage	5	Dimensional Drawings	15
Speaker Placement	6	Specifications	16
Wall Mounting	7	Warranty and Registration	17
Speaker Connection	8		
The Subwoofer	8		

SAFETY PRECAUTIONS

READ THIS SECTION CAREFULLY BEFORE PROCEEDING!

	WARNING RISK OF ELECTRIC SHOCK DO NOT OPEN	
<p>Warning: To Reduce The Risk Of Electric Shock, Do Not Remove Cover (Or Back). No User-Serviceable Parts Inside. Refer Servicing To Qualified Service Personnel.</p>		



The lightning flash with arrowpoint within an equilateral triangle warns of the presence of uninsulated “dangerous voltage” within the product’s enclosure that may be of sufficient magnitude to constitute a risk of electric shock to persons.



The exclamation point within an equilateral triangle warns users of the presence of important operating and maintenance (servicing) instructions in the literature accompanying the appliance.

WARNING: To Reduce Risk Of Fire Or Electric Shock, Do Not Expose This Product To Rain Or Moisture. Unit May Become Hot. Always Provide Adequate Ventilation To Allow For Cooling. Do Not Place Near A Heat Source, OR In Spaces That Can Restrict Ventilation.

CAUTION: To Prevent Electric Shock, Match Wide Blade Of Plug To Wide Slot, Fully Insert. For Continued Protection Against Risk Of Fire, Replace The Fuse Only With The Same Amperage And Voltage Type. Refer Replacement To Qualified Service Personnel.

IMPORTANT SAFETY INSTRUCTIONS

- 1. Read Instructions** – All the safety and operating instructions should be read before the product is operated.
- 2. Retain Instructions** – The safety and operating instructions should be retained for future reference.
- 3. Heed Warnings** – All warnings on the product and in the operating instructions should be adhered to.
- 4. Follow Instructions** – All operating and use instructions should be followed.
- 5. Cleaning** – Unplug this product from the wall outlet before cleaning. Do not use liquid cleaners or aerosol cleaners. Use a damp, soft cloth for cleaning.
- 6. Water and Moisture** – Do not use this product near water—for example, near a bath tub, wash bowl, kitchen sink, or laundry tub; in a wet basement; or near a swimming pool; and the like.
- 7. Accessories** – Do not place this product on an unstable cart, stand, tripod, bracket or table. The product may fall, causing serious injury to a child or adult, and serious damage to the product. Use only with a cart, stand, tripod, bracket or table recommended by the manufacturer, or sold with the product. Any mounting of the product should follow manufacturer's instructions and should use a mounting accessory recommended by the manufacturer.
- 8. Ventilation** – Slots and openings in the cabinet are provided for ventilation and to ensure reliable operation of the product and to protect it from overheating, and these openings must not be blocked or covered. The openings should never be blocked by placing the product on a bed, sofa, rug, or other similar surface. This product should not be placed in a built-in installation such as a bookcase or rack unless proper ventilation is provided or the manufacturer's instructions have been adhered to.
- 9. Power Sources** – This product should be operated only from the type of power source indicated on the marking label. If you are not sure of the type of power supply to your home, consult your product dealer or local power company. For products intended to operate from battery power, or other sources, refer to the operating instructions.
- 10. Grounding and Polarization** – This product may be equipped with a polarized alternating-current line plug (a plug having one blade wider than the other). This plug will fit into the power outlet only one way. This is a safety feature. If you are unable to insert the plug fully into the outlet, try reversing the plug. If the plug should still fail to fit, contact your electrician to replace your obsolete outlet. Do not defeat the safety purpose of the polarized plug.
- 11. Power-cord Protection** – Power supply cords should be routed so that they are not likely to be walked on or pinched by items placed upon or against them, paying particular attention to cords at plugs, convenience receptacles, and the point where they exit from the product.

- 12. Lightning** – For added protection for this product during a lightning storm, or when it is left unattended and unused for long periods of time, unplug it from the wall outlet and disconnect the antenna or cable systems. This will prevent damage to the product due to lightning and powerline surges.
- 13. Overloading** – Do not overload wall outlets, extension cords, or integral convenience receptacles as this can result in a risk of fire or electric shock.
- 14. Object and Liquid Entry** – Never push objects of any kind into this product through openings as they may touch dangerous voltage points or short-out parts that could result in a fire or electric shock. Never spill liquid of any kind on this product.
- 15. Servicing** – Do not attempt to service this product yourself as opening or removing covers may expose you to dangerous voltage or other hazards. Refer all servicing to qualified service personnel.
- 16. Damage Requiring Service** – Unplug this product from wall outlet and refer servicing to qualified personnel under the following conditions:
- When power supply cord or plug is damaged.
 - If liquid has been spilled, or objects have fallen into product.
 - If the product has been exposed to rain or water.
 - If the product does not operate normally by following the operating instructions. Adjust only those controls that are covered by the operating instructions as an improper adjustment of other controls may result in damage and will require extensive work by a qualified technician to restore the product to its normal operation.
 - If the product has been dropped or damaged in any way.
 - If the product exhibits a distinct change in performance – this indicates a need for service.
- 17. Replacement Parts** – When replacement parts are required, be sure the technician has used replacement parts specified by the manufacturer or have the same characteristics as the original part. Unauthorized substitutions may result in fire, electric shock, or other hazards.
- 18. Safety Check** – Upon completion of any service or repairs to this product, ask the service technician to perform safety checks to determine that the product is in proper operating condition.
- 19. Wall or Ceiling Mounting** – The product should be mounted to a wall or ceiling only as recommended by the manufacturer.
- 20. Heat** – The product should be situated away from heat sources such as radiators, heat registers, stoves, or other products (including amplifiers) that produce heat.
- 21. Unpacking** – Remove your new MartinLogan speakers from its packaging. Retain the packaging in a safe, dry place for future use.

YOUR NEW SPEAKERS

MLT-2 5.1 speakers are magnetically shielded for use near a CRT television or video screen. Keyhole slots on the rear allow them to be mounted on a wall (hardware not included).

Your speakers can also be placed on a bookshelf or desk.

POWER REQUIREMENTS

The 'Watts' (W) rating indicated on the rear panel is the maximum AC power your subwoofer will draw when producing its maximum power output. However, the actual wattage draw will vary with the bass content of the program material.

HOW TO AVOID SPEAKER DAMAGE

Use an appropriate amplifier. At high volumes, a very powerful amplifier can overdrive your speakers and damage them. On the other hand, if your amplifier isn't powerful enough, it can produce clipping distortion that can easily damage high-frequency drivers. (*See your Dealer.*)

Don't be fooled by your amplifier's volume control. It adjusts listening level—it does not indicate power output. If your speakers begin to sound harsh or grating, or if you hear the bass breaking up, turn the volume down immediately or you will damage your speakers!

This type of damage constitutes abuse and is not covered by warranty!

Tone controls and equalizers can demand even more power from an amplifier, lowering the point at which it produces clipping distortion. Use them sparingly, if at all, and do not use them when listening at loud levels.

SPEAKER PLACEMENT

Figure 1 provides a general guideline to help you get the best performance from your new system.

FRONTS (Left/Right) - MLT-2 Speakers

For the most accurate timbral balance, place your front speakers so that their high-frequency drivers are approximately ear level (see positioning ① and ②). Measure the distance from the listening area to your speakers. For optimal imaging, place the speakers approximately 3/4 of that distance from each other. MLT-2 speakers can be placed on a shelf, or wall mounted (Fig. 2 on page 7)

CENTER SPEAKER - MLT-2 Center Speaker

Place the center speaker (see position ③) above or below your TV, whichever position is closer to ear level. Position it flush with the front of the TV to minimize unwanted sound reflections. It should be about the same distance away from the primary listening area as the front speakers. (Some Audio/Video receivers and processors can electronically adjust for differences in distance.) Your center speaker can be placed on top of a TV, on a shelf, or wall mounted (see page 7 for Wall Mounting).

SURROUND SPEAKERS - MLT-2 Speakers

The surround speakers should be kept well away from the listening area for optimal surround performance.

5.1 Surround Configuration

Position speakers on each side of the listening area, (see position ④ and ⑤ in diagram).

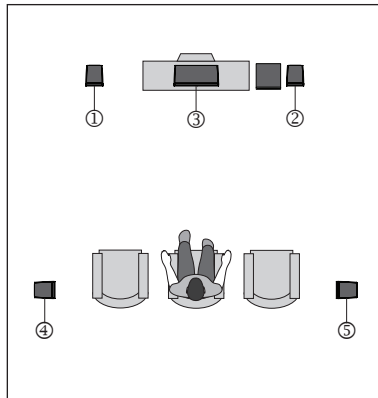

Fig. 1

WALL MOUNTING

If you are not comfortable performing the following mounting procedures, have a professional perform the installation (*see your Dealer*).

FLUSH TO WALL USING KEYHOLES

NOTE: When mounting the MLT-2 center channel, if you run speaker cable down the face of the wall, apply self-adhesive bumper pads (included) to rear corners of enclosure to accommodate the cable (see Figure 2).

1. Using #10 screws (not included) screw into the stud. (If model has two key holes, measure distance apart and use two screws). If you cannot locate a stud, use appropriate mounting hardware that will hold screws securely (*see your Dealer*). Do not screw all the way in, head should stand out approximately $3/8$ inch (9.5 mm). With the MLT-2 center channel, head should stand out $5/16$ inch (8 mm). If using bumper pads add $1/8$ inch (3 mm) to the amount head stands out.
2. Connect speaker cables as outlined in "Speaker Connection" section of this manual.
3. Align keyhole to screw head, and using an "in and down" motion mount speaker to wall.

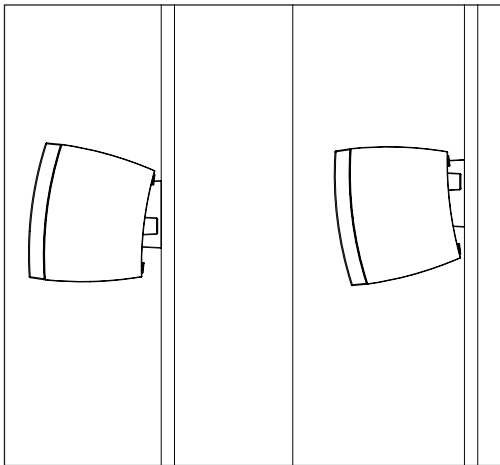

Fig. 2

SPEAKER CONNECTION



Turn your amplifier OFF before connecting speakers. This will avoid damage which could result from accidental shorting of speaker cables.

Your speakers are equipped with binding posts that can be used with banana, pin or spade connectors, as well as with bare wire. Using high-quality speaker cable (*not included, see your Dealer*), connect one speaker at a time to your receiver/amplifier. Connect the red (+) amplifier terminal to the red (+) speaker terminal and the black (-) to the black (-) (Fig. 3). Tighten the posts firmly by hand, but don't over-tighten them.

Turn your amplifier on and listen to your speakers. If you notice a complete lack of mid-bass and a dislocated image, one or more of your speakers may be connected out-of-phase (their polarity is reversed). Re-check to ensure that each speaker's cable is connected with correct polarity: red (+) to red (+) and black (-) to black (-). Make sure wires are firmly fastened.

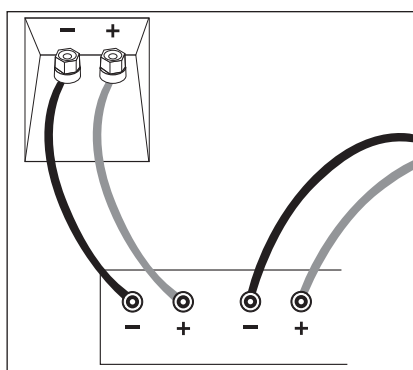

Fig. 3

THE SUBWOOFER

To achieve optimal bass performance for music and home theater, please read through the guidelines for subwoofer placement provided in the next section.

SIGNAL INPUTS

Low-Level Input

Allows connection from the LFE or Right/Left Output of an A/V receiver, processor or other suitable low-level source.

CONTROL FACILITIES

Auto On/Standby

The subwoofer will turn on when it receives an input signal and the LED will turn Green. If no signal is sensed for a period of time, the subwoofer will automatically switch to Standby and the LED will turn Red.

Control Level

Balances the subwoofer output level to your speaker system's output.

Low Pass Filter (Hz) Control

Controls the subwoofer's upper-frequency cut-off to match the low-frequency characteristics of your speakers.

Phase

Changes the phase of the subwoofer by 180° relative to your speakers.

SUBWOOFER PLACEMENT

We recommend positioning your subwoofer close to the wall, between the front speakers. Corner placement, Fig. 4 (①) provides the most bass, but sometimes at the expense of accuracy. A subwoofer placed near a wall (②) usually provides a good balance of quantity and accuracy.

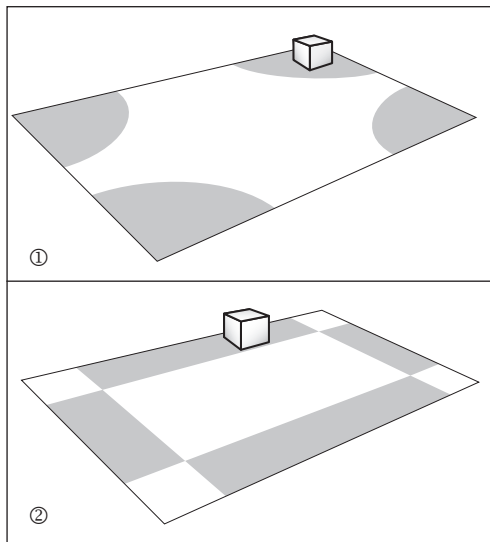

Fig. 4

SUBWOOFER CONNECTION



SAFETY PRECAUTION: Before proceeding with this section be sure to read and follow all safety precaution instruction notices at the beginning of this manual.



Turn all components OFF before connecting the subwoofer.



Ensure subwoofer is installed in a location where any rear amplifier parts (panels, heatsinks, etc.) cannot be accidentally touched.

We recommend the use of high-quality cables and connectors when hooking up your subwoofer (see your Dealer).

Low-Level Input (Fig. 5)

(For use with a receiver, processor or control unit with an LFE-Out jack.)

Using an RCA-to-RCA interconnect cable connect the subwoofer using the (LFE) Right input.

SETTING SUBWOOFER CONTROLS

When setting up your subwoofer and fine tuning it with your system, use music and video soundtracks that you know well. They should contain selections with extended bass that is continuous and repetitive. Set any tone or equalizer controls on your receiver or preamplifier to flat (zero) and switch any loudness controls off.

Room acoustics vary. Experiment with subwoofer placement to find the best position. Certain subwoofer positions may cause some bass frequency cancellation—when your speakers and subwoofer are “out-of-phase” they work against each other through the crossover region and bass is reduced. If bass sounds “weak” or “dislocated,” change the phase according to the instructions in point 4, on page 11. When adjusting your subwoofer, remember that bass should not be overbearing—the subwoofer should not draw attention to itself—but it shouldn’t be “thin” or difficult to hear, either. Use the following set-up tips to fine-tune subwoofer bass in your listening room:

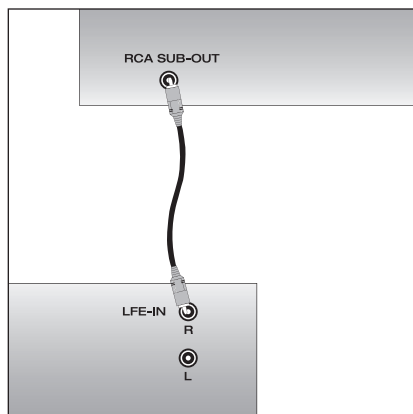

Fig. 5

SETTING SUBWOOFER CONTROLS *(continued)*

1. Turn the **Low Pass Filter (Hz) Control** to the middle of the **“Normal”** range.
2. Slowly rotate the **Level Control** until you match the subwoofer output level with the level of your speakers. Bass should be clearly audible but not intrusive.
3. If the sound is too “thin” set the **Low Pass Filter Control** higher than the “Normal” range; if the sound becomes “boomy” set the **Low Pass Filter Control** lower than the normal range.
4. If the bass sounds weak or “dislocated” you may have a phase alignment problem. Your MLT-2 subwoofer has a **Phase Switch** which is normally set to the 0° position. Switch it to the 180° position—this will switch the phase of the subwoofer by 180° relative to your speakers. Listen to determine if you hear more bass. If you don’t hear more bass, return the Phase Switch to its original position and then experiment with subwoofer placement to find an area of the room where there is less bass cancellation.

(FAQ) FREQUENTLY ASKED QUESTIONS

How do I clean my speakers and subwoofer?

Just use a dust free cloth or a soft brush to remove the dust from your speakers. We recommend a specialty cloth (available at the Xtatic shop at www.martinlogan.com) that cleans your speakers better than anything else we have tried.

What size amplifier should I use?

We recommend an amplifier with 50–100 watts per channel for most applications. Probably less would be adequate when used in home theater where a subwoofer is employed. The speakers will perform well with either a tube or transistor amplifier, and will reveal the sonic character of either type.

Could you suggest a list of suitable electronics and cables ideal for MartinLogan speakers?

The area of electronics and cable choice is probably the most common type of question that we receive. It is also the most subjective. We have repeatedly found that brands that work well in one setup will drive someone else nuts in another. We use many brands with great success. Again, we have no favorites; we use electronics and cables quite interchangeably. We would suggest listening to a number of brands—and above all else—trust your ears. Dealers are always the best source for information when purchasing additional audio equipment.

Is there likely to be any interaction between my speakers and the television in my A/V system?

No. The MLT-2 and MLT-2 center speakers are shielded and can be used with a CRT television.

Will exposure to sunlight affect the life or performance of my speakers?

We recommend that you not place any loudspeaker in direct sunlight. The ultraviolet (UV) rays from the sun can cause deterioration of grill cloth, speaker cones, etc. Small exposures to UV will not cause a problem. In general, the filtering of UV rays through glass will greatly reduce the negative effects.

Is it safe to set things on my subwoofer?

While your MLT-2 subwoofer is designed with a durable, stain-resistant surface, we advise you not to set anything on your MLT-2 subwoofer—especially containers holding liquids.

Is there likely to be any interaction between my subwoofer and the television in my Audio/ Video system?

Yes. The MLT-2 subwoofer doesn't use a shielded driver. We recommend 3 feet between the MLT-2 subwoofer and video components that are susceptible to magnetic fields, such as CRT televisions.

Will my electric bill go 'sky high' by leaving my subwoofer plugged in all the time?

No. The MLT-2 5.1 subwoofer, when the power switch is set to 'Auto On', will draw about 12 watts when idle and only 12 watts in standby mode.

Should I unplug my subwoofer during a thunderstorm?

Yes, or before. It's a good idea to disconnect all of your audio/video components during stormy weather.

TROUBLESHOOTING

SPEAKER

No Output

- Check that all your system components are turned on.
 - Check your speaker wires and connections.
 - Check all interconnecting cables.
-

SUBWOOFER

No Output

- Check that all your system components are turned on.
- Check that the power switch is set to 'Auto On'.
- Check your wires and connections.
- Check all interconnecting cables.
- Make sure the level control is not turned down.
- Turn off and unplug the MLT-2 subwoofer and check the fuse near the AC power cord receptacle on the back. If the fuse has blown, replace the bad fuse with a matching fuse.
- If the problem persists, contact your dealer.

Muddy Bass

- Check placement. Try moving the subwoofer closer to the front and side walls.
- Decrease the level.
- Check your processor setup.
- If the problem persists, contact your dealer.

Hums or Unusual Sounds

- Turn the MLT-2 subwoofer off, unplug all signal inputs, turn the MLT-2 subwoofer back on and turn up the level. If the problem disappears, the hum is originating elsewhere in your system.
- Connect the MLT-2 subwoofer AC connection to the same AC circuit as the pre amp.
- If the problem persists, contact your Dealer.

SERIAL NUMBER

MLT-2 5.1 speaker serial numbers are located directly beneath the binding posts. On the MLT-2 subwoofer the serial number is located on the back panel.

SERVICE

Should you be using your MartinLogan product in a country other than the one in which it was originally purchased, we ask that you note the following:

1. The appointed MartinLogan distributor for any given country is responsible for warranty servicing only on units distributed by or through it in that country in accordance with its applicable warranty.
2. Should a MartinLogan product require servicing in a country other than the one in which it was originally purchased, the end user may seek to have repairs performed by the nearest MartinLogan distributor, subject to that distributor's local servicing policies, but all cost of repairs (parts, labor, transportation) must be borne by the owner of the MartinLogan product.
3. If, after owning your speaker for six months, you relocate to a country other than the one in which you purchased your speaker, your warranty may be transferable. Contact MartinLogan for details.

DIMENSIONAL DRAWINGS

MLT-2 Speaker

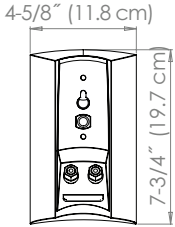
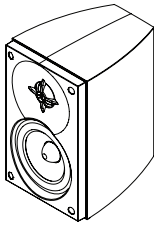
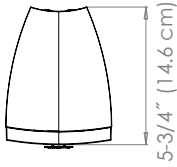

MLT-2 Center Channel

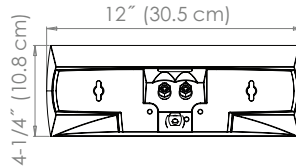
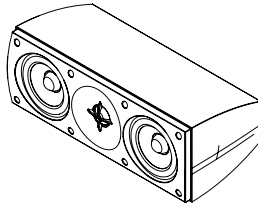
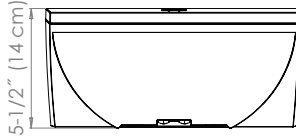

MLT-2 Subwoofer

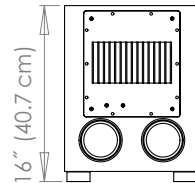
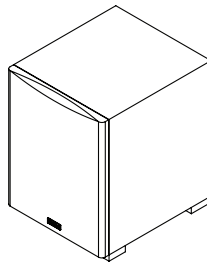
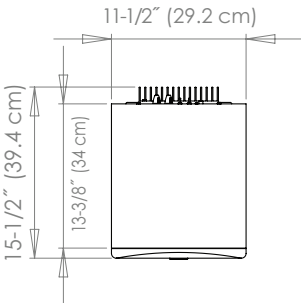

SPECIFICATIONS

MLT-2 SPEAKER

System Frequency Response

110–20,000 Hz \pm 2db

Sensitivity

88 dB@2.83 volts/meter

Impedance

8 Ohms compatible

Crossover Frequency

2000Hz

Tweeter Type

1" (2.54 cm) soft dome

Woofer Type

4.5" (11.5 cm) high rigidity poly cone with extended throw drive assembly

Enclosure Type

Non-resonance asymmetrical chamber format, sealed

Suitable Amplifier Range

15–100 watts

Power Handling

50 watts

Weight

3.4 lbs. (1.6 kg)

Size*

7-3/4" h x 4-5/8" w x 5-3/4" d
(19.7 h x 11.8 w x 14.6 d cm)

MLT-2 CENTER CHANNEL

System Frequency Response

130–20,000 Hz \pm 2db

Sensitivity

89 dB@2.83 volts/meter

Impedance

8 Ohms Compatible

Crossover Frequency

2300Hz

Tweeter Type

1" (2.54 cm) soft dome

Woofer Type

2 x 3.5" (8.9cm) high rigidity poly cone with extended throw drive assembly

Enclosure Type

Non-resonance asymmetrical chamber format, sealed

Suitable Amplifier Range

15–100 watts

Power Handling

50 watts

Weight

5 lbs. (2.2 kg)

Size*

4-1/4" h x 12" w x 5-1/2" d
(10.8 h x 30.5 w x 14 d cm)

MLT-2 SUBWOOFER

System Frequency Response

37–200 Hz \pm 3 dB. Anechoic in the LFE mode.

Low Pass Filter Frequencies

50Hz–200Hz

Phase

0°, 180°

Woofer Type

10" (25.4 cm) high-excursion, paper cone with extended throw driver assembly

Enclosure Type

Bass reflex

Amplifier

120 watts RMS (360 watts peak)

Impedance

Left & Right/LFE RCA – 10,000 Ohms

Inputs

Left & Right/LFE RCA Line Level

Mains Power Draw

Standby: 12W

Idle: 12W

Max: 250W

Weight

32.6 lbs. each (14.8 kg)

Size*

16" h x 11-1/2" w x 15-1/2" d
(40.7 h x 29.2 w x 39.4 d cm)

*For detailed dimensional drawings, please see page 15.
Specifications are subject to change without notice.

WARRANTY INFORMATION AND REGISTRATION

Limited Ninety Day Warranty

MartinLogan, Ltd, warrants the product designated herein to be free of manufacturing defects in material and workmanship, subject to the conditions hereinafter set forth, for a period of ninety (90) days from the date of purchase by the original purchaser.

Conditions

This warranty is subject to the following conditions and limitations: the warranty is void and inapplicable if the product has been used or handled other than in accordance with the instructions in the owner's manual, abused or misused, damaged by accident or neglect or in being transported, or the defect is due to the product being repaired or tampered with by anyone other than MartinLogan or an authorized MartinLogan repair center. If returned, the product must be properly packaged and shipped to MartinLogan or an authorized MartinLogan repair center by the customer at his or her sole expense. A returned product must be accompanied by a written description of the defect and proof of the date of purchase. MartinLogan reserves the right to modify the design of any product without obligation to purchaser of previously manufactured products and to change the prices or specifications of any product without notice or obligation to any person.

Exclusions

Any implied warranties relating to the above product shall be limited to the duration of the above warranty. The warranty does not extend to any incidental or consequential costs or damages to the purchaser. Some states do not allow limitations on how long an implied warranty lasts or an exclusion or limitation of incidental or consequential damages, so the above limitations or exclusions may not apply to you. This warranty gives you specific legal rights, and you may also have other rights which vary from state to state. This warranty represents a limited warranty as per definition by the Federal Trade Commission (Magnuson-Moss Warranty Act).

Warrantor

Inquiries regarding the above Limited Ninety Day Warranty may be sent to the address on the next page.

Limited Five Year (Three Year for subwoofers) Warranty Registration *(see enclosed)*

Automatic Coverage

Thank you for purchasing this MartinLogan product. We have made every effort to ensure that it represents the highest level of performance, reliability and finish. Your MartinLogan product is covered by a Limited Ninety Day Warranty whose terms are specified in the Limited Ninety Day Warranty. This ninety day coverage is automatic upon your acceptance of delivery and no registration is required.

Extended Warranty Coverage

Additionally, you have the option, at no cost to you, to secure extended warranty coverage for a period of Five (5) years (Three (3) years for subwoofer) from the date of purchase by simply returning the enclosed completed Warranty Registration Card within thirty (30) days of product delivery.

Online Warranty Registration

For your convenience MartinLogan also offers online warranty registration at www.martinlogan.com.

OPTIONAL LIMITED FIVE YEAR (THREE YEAR FOR SUBWOOFERS) WARRANTY

Upon receipt of the completed Limited Five Year Warranty (Three Year on MLT-2 subwoofer) Registration Card, the registered product will carry the following warranty coverage:

Limited Warranty

MartinLogan warrants the product designated herein to be free of manufacturing defects in material and workmanship, subject to the conditions hereinafter set forth, for a period of Five (5) years (Three (3) years for MLT-2 subwoofer) from the date of purchase by the original purchaser.

Conditions

This warranty is subject to the following conditions and limitations. The warranty is void and inapplicable if the product has been used or handled other than in accordance with the instructions in the owner's manual, abused or misused, damaged by accident or neglect or in being transported, or the defect is due to the product being repaired or tampered with by anyone other than MartinLogan or an authorized MartinLogan repair center. Any modification (electrical, mechanical, or cosmetic) may, at MartinLogan's discretion, void the warranty. If returned, the product must be properly packaged and shipped to MartinLogan or an authorized MartinLogan repair center by the customer at his or her sole expense. A returned product must be accompanied by a written description of the defect and a photocopy of the validated warranty. MartinLogan reserves the right to modify the design of any product without obligation to purchasers of previously manufactured products and to change the prices or specifications of any product without notice or obligation to any person.

Remedy

The above Warranty and the above conditions have been met, the purchaser's sole remedy under this Limited Warranty shall be to return the product. If you find yourself in this situation, first contact the dealer from whom you purchased the product. If you purchased your product outside the USA you must work with your distributor to resolve your issue. If you purchased your product in the USA and your MartinLogan dealer cannot help you, you may contact MartinLogan directly to resolve your issue. All factory product return issues must be reviewed and have a Return Authorization approved and issued by the MartinLogan factory before the product can be returned.

Restriction

This Warranty is for the sole benefit of the original purchaser of the covered product, is restricted to the original purchaser, and shall not be transferred to a subsequent purchaser of the product.

Duration

This Warranty expires on the fifth anniversary (third anniversary for MLT-2 subwoofer) of the date of purchase. During the first ninety (90) days following the date of purchase by the original purchaser, the MartinLogan Limited 90 Day Warranty supersedes this Warranty.

Exclusions

Any implied warranties relating to the above product shall be limited to the duration of the above warranty. The warranty does not extend to any incidental or consequential costs or damages to the purchaser. Some states do not allow limitations on how long an implied warranty lasts or an exclusion or limitation of incidental or consequential damages, so the above limitations or exclusions may not apply to you. This Warranty gives you specific legal rights, and you may also have other rights which vary from state to state. This Warranty represents a limited warranty as per definition by the Federal Trade Commission (Magnuson-Moss Act).

Warrantor

Inquiries regarding the above limited Warranty may be sent to the following address:

MartinLogan
2101 Delaware
Lawrence, Kansas 66046



WARNING: Do not use your MLT-2 5.1 loudspeaker system outside of the country of original sale—voltage requirements vary by country. Improper voltage can cause damage that will be potentially expensive to repair. The MLT-2 5.1 is shipped to authorized MartinLogan dealers with the correct power supply for use in the country of intended sale. A list of authorized dealers can be accessed at www.martinlogan.com or by emailing info@martinlogan.com.



Lawrence, Kansas. USA tel 785.749.0133 fax 785.749.5320 www.martinlogan.com

© 2010 MartinLogan. All rights reserved.

Rev. #082310

Download from Www.Somanuals.com. All Manuals Search And Download.

Free Manuals Download Website

<http://myh66.com>

<http://usermanuals.us>

<http://www.somanuals.com>

<http://www.4manuals.cc>

<http://www.manual-lib.com>

<http://www.404manual.com>

<http://www.luxmanual.com>

<http://aubethermostatmanual.com>

Golf course search by state

<http://golfingnear.com>

Email search by domain

<http://emailbydomain.com>

Auto manuals search

<http://auto.somanuals.com>

TV manuals search

<http://tv.somanuals.com>