

FREE VIDEO OFFER!



'Outdoor Cooking Made Simple'

From European and Southern style cooking to Louisiana Cajun and Midwest flavors, hosts Don and John McLemore guide viewers, step by step, through the world of smoking, grilling, frying and boiling. Let more than 20 recipes, tempt your taste buds and open up a world of rich flavor and awesome eating.

- Yes, I would like the free video 'Outdoor Cooking Made Simple.' I have included my payment (check or money order) for shipping and handling charges.

Shipping within continental United States \$5.95

For shipping rates outside the continental United States or for Visa or Mastercard orders, call 1-800-489-1581 and ask for one of our Customer Service Representatives.

ONLINE VIDEO

Visit our web site to view online videos. www.masterbuilt.com

Send this page, your return address, plus check or money order in an envelope to:

Masterbuilt Outdoor Products
450 Brown Avenue,
Columbus, GA 31906

Attn: Warranty Department

www.masterbuilt.com

MASTERBUILT PEDESTAL GRILL

MODELS

SBMPG3, SMPG3

WARNING

1. Never operate this grill unattended.
2. Never operate this grill under any overhead roof covering (car port), awning or overhang. Keep a minimum clearance of 2 feet (3m.) from all sides of the grill to all construction. Keep the area clear of all flammable liquids, combustible material including but not limited to wood (all forms), dry plants including grass, brush, paper, and canvas.
3. Grill is HOT while in use and after do not touch.

Failure to follow these instructions and warnings properly could result in fire or explosion, which could cause property damage, personal injury, or death.

STOP & READ

This unit is 100% assembled. Review Page 3 before using to make sure all parts are in place.

WARNING

1. Do not store spare LP cylinder within 10 feet (3 m) of this appliance.
2. Do not store or use gasoline or other flammable liquids or vapors within 25 feet (8 m) of this appliance.

DANGER

For Your Safety, If you smell gas:

1. Shut off gas to the grill.
2. Extinguish any open flame.
3. Open Lid.
4. If odor continues, immediately call your Fire Department.

Failure to follow these instructions and warnings properly could result in fire or explosion, which could cause property damage, personal injury, or death.

This instructions manual contains important information necessary for the proper and safe use of the grill.

Read and follow all warnings and instructions before using grill.

Follow all warnings and instructions when using the grill.

Keep the manual for future reference.

This unit can not be converted to use natural gas. Use propane gas only.



If you need help or parts are missing do not return to dealer. Contact Masterbuilt first, 1-800-489-1581

Manual Code 122303G



WARNING

- The Gas grill is for **OUTDOOR USE ONLY**.
- Never use inside an enclosed area such as screen patios, garage, buildings, tents.
- Never use in or on recreational vehicles and/or boats. Never use this grill as a heater.
- Never operate this grill under any overhead construction. Keep a minimum clearance of 2 feet from overhead construction, walls or rails.
- Keep the area clear of any combustible material. (Things that burn.)
- Use this grill only on a level, stable surface.
- Never use this product for anything other than its intended purposes. This grill is not intended for commercial use.
- Keep children and pets away from the grill at all time.
- Never move the grill when it is in use. Allow the grill to cool below 115°F (40°C) before moving or storing it.
- Avoid touching hot surfaces this grill is hot.
- Accessory attachments not manufactured or supplied by Masterbuilt for this grill are not recommended for use.
- Keep fuel supply hose away from the grill while in operation.



FOR YOUR SAFETY

- Do not store or use gasoline or other flammable vapors and liquids in the vicinity of this or any other appliance.
- An LP cylinder not connected for use shall not stored in the vicinity of this or any other appliance.

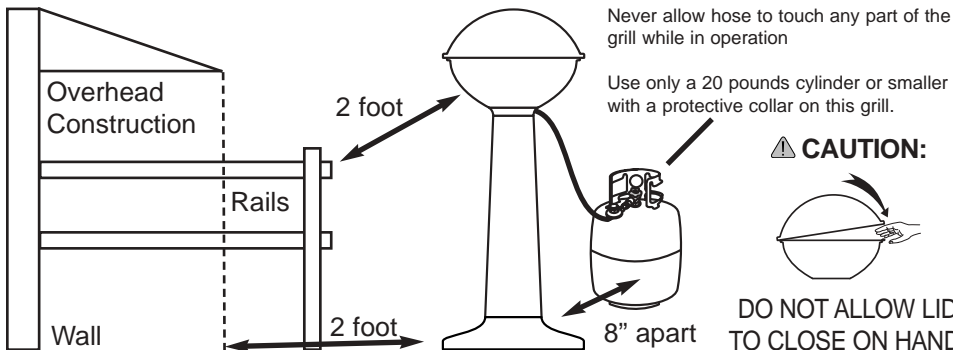

WARRANTY INFORMATION

Masterbuilt warrants the burner, regulator control valve, hose, and heat indicator to be free from defects in material and workmanship for one year. **All stainless steel parts for five years.**

Masterbuilt warranty does not cover rust of the unit. Within this period, Masterbuilt, shall correct any defect by repairing or replacing defective parts of the equipment or making available the parts from, Columbus, Georgia, F.O.B.

Masterbuilt requires reasonable proof of purchase and suggests that you keep your receipt. Failure to complete and return warranty information will make product warranty null and void. Upon the expiration of such warranty, all such liability shall terminate.

This warranty does not include the cost of property damage due to the failure of the product and does not cover damage due to the misuse, abuse, accident, damage arising out of transportation, or damage incurred through commercial use of this product. THIS EXPRESS WARRANTY IS THE SOLE WARRANTY GIVEN BY THE MANUFACTURER AND IS IN LIEU OF ALL OTHER WARRANTIES, EXPRESSED OR IMPLIED, INCLUDING IMPLIED WARRANTY OR MERCHANTABILITY OR FITNESS FOR A PARTICULAR PURPOSE. Neither Masterbuilt, nor the retail establishment selling this product, has authority to make any warranties or to promise remedies in addition to or inconsistent with those stated above. Masterbuilt's maximum liability, in any event, shall not exceed the purchase price of the product paid by the original consumer/purchaser. Some states do not allow the exclusion or limitation of incidental or consequential damages. In such a case, the above limitations or exclusions may not be applicable.

Notwithstanding this limitation of warranty, the following specific restrictions apply for California residents. If service, repair, or replacement of the product is not commercially practicable, the retailer selling the product or Masterbuilt will refund the purchase price paid for the product, less the amount directly attributable to use by the original buyer prior to the discovery of the nonconformity. In the state of California only, you may take the product to the retail establishment selling this product, in order to obtain performance under warranty.

This expressed warranty gives you specific legal rights, and you may also have other rights which vary from state to state.

NOTE: Paint finish may burn off under normal use and therefore it carries no warranty.

MASTERBUILT PEDESTAL GRILL WARRANTY INFORMATION

To validate your warranty, please fill out and return this portion within 30 days of the date of purchase.

SEND TO:

Masterbuilt Outdoor Products, 450 Brown Avenue, Columbus, GA 31906
ATTN: Warranty Department

Cut Line

1. Name _____
2. Address _____
City _____
State _____ Zip _____
3. Dealer's Name _____
4. Dealer's Location _____
5. Date of Purchase _____
6. What brand of outdoor cooking products have you previously owned (optional)?

7. Serial # _____ and/or Model # _____

TRY SOUTHERN SECRETS

Spices, Marinades, BBQ Sauces and Batters



Kickin' Cajun Seasoning for Frying Turkeys
Steak Seasoning for Frying or Grilling
BBQ Rub for Smoking Ribs and More

Injectable Turkey Marinades



Garlic & Herb or Buttery Creole

ALSO TRY: Sizzlin Steak Marinade, Glazing Honey Injectable Marinade, Kickin' Cajun Hot Wing Sauce, Hot and Spicy BBQ Sauce and Grandma's Mild BBQ Sauce

Fish & Seafood Batters



Original Crispy Batter
Original Crispy Cajun Batter
Southern Style Corn Meal Breading

Gift Packs



Turkey Cookin' Kit



Steak & BBQ Cookin' Kit



Fish & Wing Cookin' Kit



WARNING

- Always perform the soapy water test every time you use grill.
- Avoid bumping or impact of the grill.
- Always disconnect your gas cylinder from your grill when not in use.
- Keep your hands, hair and face away from the burner flame. Do not lean over grill when lighting the burner. This grill has an open flame. Be careful of loose hair and clothing during operation. They could catch fire.
- Never attach a gas cylinder, move or alter fittings when the grill is hot or in use.
- Do not attempt to disconnect any gas fitting while your grill is in use.
- Never use a gas cylinder if it shows signs of: dents, gouges, bulges, fire damage, erosion, leakage, excessive rust, or other forms of visible external damage. The cylinder may be hazardous and should be checked by a liquid propane supplier.
- If burner does not ignite, turn OFF the control valve and gas and wait 5 minutes before trying to light it again. If the burner goes out during operation, first turn control valve OFF, then the gas cylinder OFF.
- Do not allow anyone to conduct activities around your grill during or following its use until the unit has cooled. The grill is hot during operation and remains hot for a period of time following its use.
- Be careful when removing food from the grill for it is hot and could cause burns.
- Never use glassware, plastic, or ceramic cookware on this grill.
- When grill use is complete, always turn the gas control valve OFF first, then the gas cylinder valve OFF.
- Preheating grill is not necessary. If preheating is desired, opening dome can release intense heat. Use caution.



CAUTION

- Fatty foods (like hamburgers) can have excess grease and can cause flare up. When cooking fatty foods, use a low setting with lid open.
- Clean flame disk & internal base pan before each use. (See Page 5 for parts list). This will cut down on build-up and flare ups.



WARNING

- **The use of alcohol, prescription or non prescription drugs may impair the consumer's ability to properly assemble or safely operate the grill.**
- **Do not obstruct flow of combustion and ventilation. Keep the ventilation opening(s) of the cylinder enclosure free and clear of debris.**
- **The installation of this grill must conform with local codes or, in the absence of local codes, with the National Fuel Gas Code, ANSI Z223.1, Storage and Handling of Liquefied Petroleum Gases, ANSI/NFPA 58 or CSA B149.1, Natural Gas Installation Code or CAN/CGA-B149.2, Propane Installation Code.**
- **The LP-gas cylinder being used must be constructed and marked in accordance with the specifications for LP-gas cylinders of the U.S. Department of Transportation (DOT) CFR 49 or the National Standards of Canada, CAN/CSA-B339, Cylinders, Spheres and Tubes for the Transportation of Dangerous Goods.**

GRILLING RECIPES

GRILLED ZUCCHINI HALVES

- 2 large zucchini
- 4 tbs. olive oil
- 2 tbs. Southern Secrets Sizzlin' Steak Seasoning

Trim Zucchini ends and wash thoroughly. Cut in half. Make 4 cuts in zucchini 1/8 inch deep. Rub each half with 1 TBS. olive oil and 1/2 TBS. Southern Secrets Sizzlin' Steak Seasoning.

Grill on medium heat for 20 min.

GRILLED FLANK STEAK

1 1/2 lbs flank steak

Marinate in:

- 1/4 cup Worcestershire sauce
- 1/3 cup soy sauce
- 1tsp. dried, ground ginger or freshly chopped ginger and the juice of 1 lemon

Place steak in shallow glass casserole dish and pour marinade over top. Let marinate at least 3 hours, turning every hour or so. Remove from smoker and place on grill for 3 to 4 minutes on each side. Slice diagonally and serve.

CARIBBEAN FLAVOR CHICKEN

- 1 tsp. salt
- 1 clove garlic, peeled, plus 2 cloves, minced
- 1 1/2 teaspoons dried leaf oregano
- 1/4 teaspoon paprika
- 1 tablespoon lemon or lime juice
- 8 chicken pieces (breasts, thighs, drum sticks)
- 3 tablespoons oil
- 1 small onion, minced
- 1/3 catsup
- 1/3 cup cider vinegar
- Mash salt with peeled garlic to make a paste. Work in 1-1/2 teaspoon oregano, paprika and lemon juice. Rub this mixture over the chicken. Place chicken over hot coals and grill, turning every 7 to 8 minutes, until done. Stir in catsup, vinegar and remaining oregano, and simmer 15 minutes. When chicken is done, brush on chicken and grill 5 minutes longer. Place onto a warm platter and serve remaining sauce at table. Fried plantain or grill-baked bananas or saffron rice go well with this.

GRILLED FRESH PINEAPPLE

- 1 1/2 sticks of butter or margarine
- 1 tablespoon of garlic powder

Peel and clean fresh pineapple. Cut into serving pieces and place on grill. Mix butter and garlic powder well. Baste each piece of pineapple while cooking. Cook until golden brown. Serve as a side dish with chicken or pork.

GRILLING RECIPES

TENDERLOINS WITH BLUE CHEESE BUTTER

- 1/4 cup margarine or butter-softened
- 1/2 tsp. lemon juice
- 1/8 tsp. pepper
- 1/4 cup crumbled blue cheese
- 8 slices bacon
- 4 10-ounce beef tenderloin or top loin steaks, cut 1 inch thick

For blue cheese butter, in a small mixing bowl, stir together margarine or butter, lemon juice, and pepper. Fold in blue cheese and mix just till combined.

In a skillet, cook bacon till almost done, but not crisp. Drain off fat, pat bacon with paper towels to remove excess fat. Wrap bacon around steaks, securing with wooden toothpicks.

Preheat gas grill. Adjust heat for direct cooking. Place steaks on grill rack over medium heat. Cover and grill for 8 to 12 minutes for rare (140 degrees) or 12 to 15 minutes for medium (160 degrees.) Serve steaks with a spoonful of blue cheese butter.

SAUCY CHERRY CHICKEN PIECES

- 1 cup cherry preserves
- 1 tbs. margarine or butter
- 1/2 tsp. finely shredded lemon peel
- 2 tbs. lemon juice
- 1/2 tsp. ground cinnamon
- 1/4 tsp. ground allspice
- 1/8 tsp. salt
- Dash of ground cloves
- 2 to 2 1/2 lbs. chicken pieces

For sauce, in a small sauce pan combine cherry preserves, margarine or butter, lemon peel, lemon juice, cinnamon, allspice, salt, and cloves. Cook and stir until all combined.

Remove skin from chicken (if desired red) Rinse chicken; pat dry. Preheat gas grill. Adjust heat for direct cooking. Place chicken, bone side up on grill rack over medium heat. Cover and grill for 35 to 45 minutes or until tender and no longer pink. Turn chicken halfway through cooking. Brush with sauce frequently the last 10 minutes of grilling.



DANGER

Gas Cylinder Placement and Filling:

- **Do not store a spare LP-gas cylinder under or near grill. The gas cylinder safety relief valve may overheat, allowing gas to release causing and intense fire with rise of death or serious injury.**
- **Never fill the cylinder beyond 80 percent full. Overfilled cylinders can release gas.**
- **If you smell, hear or see gas escaping immediately get away from the gas cylinder and call the Fire Department.**



FOR YOUR SAFETY

Gas Cylinder Storage and Grill Check:

Cylinders must be stored outdoors out of reach of children and must not be stored in a building, garage, or any other enclosed area. Before each use check all nuts and bolts to be sure that they are tight and secure. Before each use perform soapy water test. Before each use, inspect gas hose for any signs of abrasion, cuts, leaks, or wear. If replacement is needed, contact Masterbuilt Manufacturing for regulator hose model # BPRLP19.

GRILL ASSEMBLY, CONFIGURATIONS & PARTS LIST

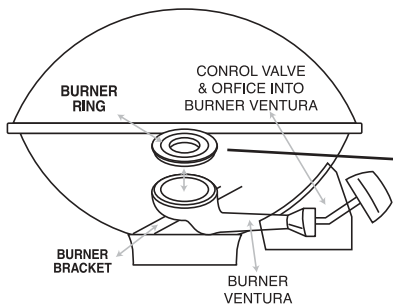
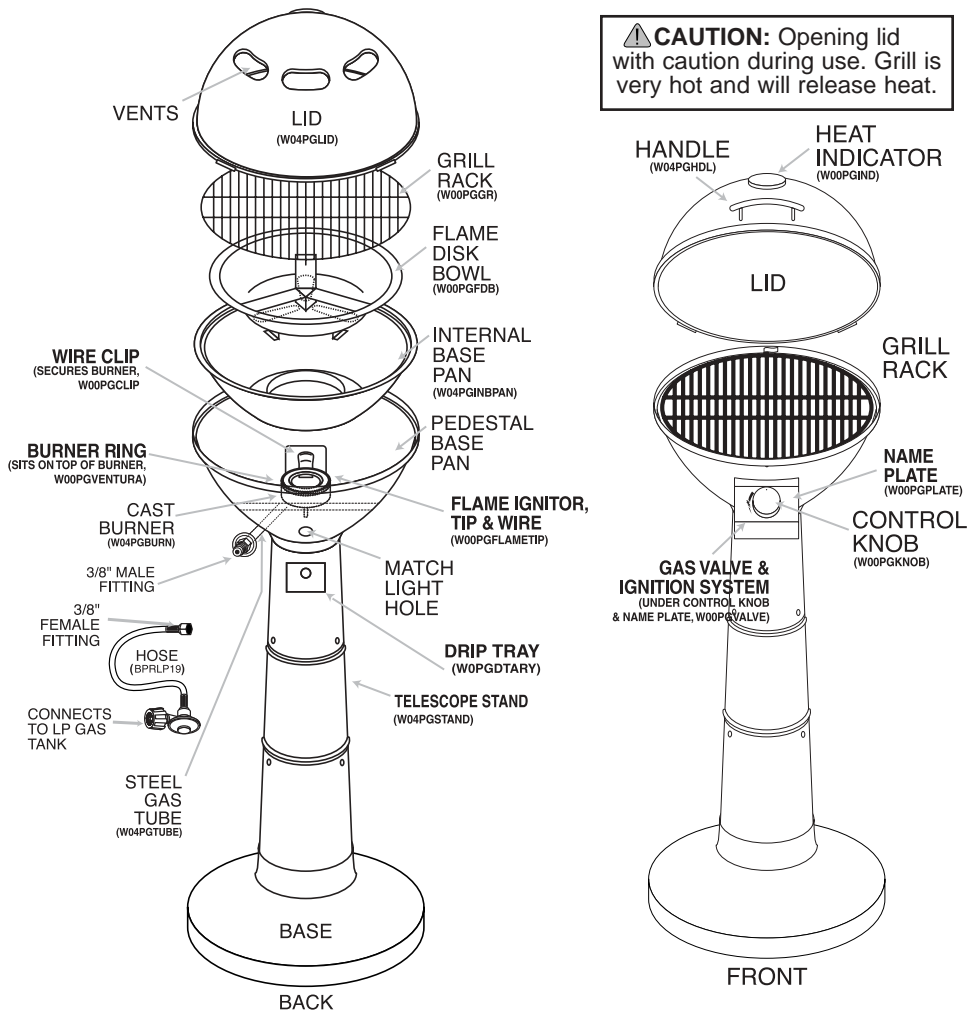

BURNER RING CHECK

BEFORE LIGHTING GRILL, CHECK BURNER RING TO MAKE SURE IT IS FIRMLY IN PLACE & FLAT ON TOP OF CAST BURNER BEFORE LIGHTING. IF THE BURNER RING IS NOT IN PLACE PROPERLY, THE BURNER WILL NOT BURN CORRECTLY, PRODUCING A LOW FLAME.

STAND ASSEMBLY

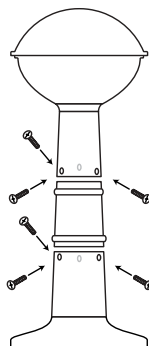

- 1) Mount center post first to the base and secure with three screws.
2. Mount grill head to the center post using three screws.

GRILLING RECIPES

GRILLED BONELESS CHICKEN BREASTS

- 4-6 Boneless Chicken Breasts
- 1 bottle of Southern Secret's Grandma's Mild BBQ Sauce

- 1) Place each chicken breast on cutting board and trim off skin and fat.
- 2) Cut horizontal chicken breast in half.
- 3) Pierce each chicken breast with a fork several times.
- 4) Place chicken breast in medium bowl and cover with Southern Secret's Grandma's Mild BBQ Sauce. Cover and refrigerate. The longer the better.
- 5) On low heat, grill chicken breasts 10 to 12 minutes brushing on marinade from bottle. Turn half way through. Cook chicken breast thoroughly.

GRILLED PORK TENDERLOIN

- 1 Pork Tenderloin 2 to 3 lbs.
- 1 bottle of Southern Secrets Garlic and Herb Marinade

- 1) Pierce pork tenderloin with a fork to allow marinade to permeate though the meat.
- 2) Place pork tenderloin in resealable plastic bag and pour in 1 bottle of Southern Secrets Garlic and Herb Marinade. Cover and refrigerate. The longer the better.
- 3) Place marinated pork tenderloin on aluminum foil and pour

marinade over tenderloin.

- 4) Seal up foil with marinade and tenderloin, over wrap with foil again.
- 5) Place on low heat; grill for 30 to 40 minutes, turning often.
- 6) Cook tenderloin thoroughly and serve.

GRILLED MARINATED STEAKS CHUCK STEAKS, T-BONES OR SIRLOIN STEAK

- 2 to 2 1/2 lb. Sirloin Steak about 1 inch thick.
- 1 bottle Southern Secret's Sizzlin' Steak Marinade

- 1) Pierce steak with forks completely.
- 2) Place Steak in shallow dish or Large resealable plastic bag.
- 3) Cover meat with Southern Secret's Sizzlin' Steak Marinade.
- 4) Cover or seal and refrigerate at least 2 hours.
- 5) Remove meat discard marinade.
- 6) Grill over medium coals until meat is grilled as desired.
- 7) 6-7 minutes per side for rare, 8-10 minutes per side for medium, 11- 13 minutes per side for well done.

SAFE STORAGE & MAINTENANCE

- ALWAYS turn gas OFF at the gas cylinder valve prior to inspecting parts.
- ALWAYS empty Drip Tray, located in back of unit, after to each use.
- DO NOT obstruct flow of combustion and ventilation. Keep the ventilation opening(s) of the cylinder enclosure clear of debris. The cylinder supply system must be arranged for vapor withdrawal.
- ALWAYS allow your grill to cool completely before handling.
- When grill is not in use, the gas must be turned off at the supply cylinder.
- ALWAYS disconnect your gas cylinder after using your grill.
- Clean grill, including special surfaces such as grill racks with cleaning agents. Wipe outside of unit with a damp rag. (Do Not Use Oven Cleaner)
- ALWAYS cover and store your grill in a protected area.
- Gas cylinders must be stored outdoors out of the reach of children and must not be stored in a building, garage or any other enclosed area.
- Always store gas cylinder upright and in areas where temperatures won't exceed 125° F.
- Indoor storage of grill is permissible only if the cylinder is disconnected and removed.
- With normal use, some bronzing may occur.

REGULATOR TO GAS CYLINDER VALVE CONNECTION

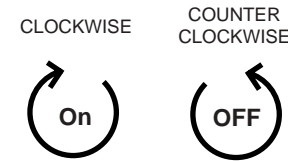

WARNING

Extinguish all open flames before connecting the regulator to the gas cylinder.

GAS CONTROL VALVE OPERATIONS

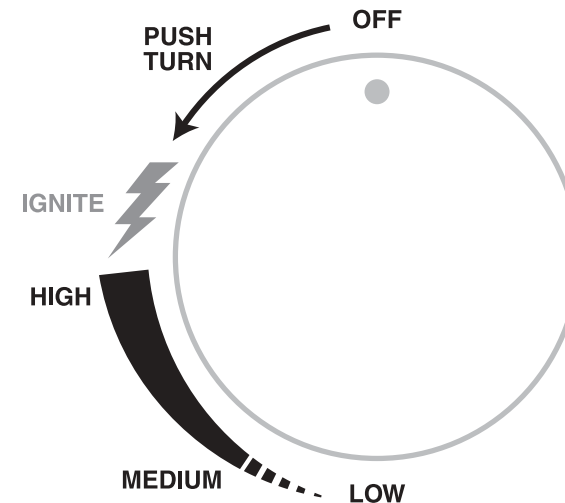

USE CAUTION WHEN OPENING LID TO PREVENT BURNS FROM ESCAPING HEAT AND FLARE UP

LIGHTING INSTRUCTIONS

1. READ ALL INSTRUCTIONS AND WARNINGS BEFORE LIGHTING
2. OPEN LID DURING LIGHTING
3. TURN GAS CONTROL KNOB OFF, TURN GAS CYLINDER VALVE ON
4. PUSH DOWN CONTROL KNOB AND TURN LEFT TO 'IGNITE' AND LIGHT
5. REPEAT UP TO THREE TIMES IF NECESSARY
6. IF IGNITION DOES NOT TAKE PLACE IMMEDIATELY, WAIT FIVE MINUTES AND THEN MATCH LIGHT, SEE INSTRUCTION MANUAL

SOAPY WATER TEST WARNING AND PROCEDURES

- The Soapy Water Test must be performed each time the gas cylinder is connected to your grill or each time the grill is used.
- The Soapy Water Test must be performed outdoors in a well-ventilated area.
- When performing the Soapy Water Test, always keep grill away from open flames, sparks, or lit cigarettes. Never use an open flame to test for gas leaks.
- This product will not operate with natural gas.

PROCEDURE:

1. Turn gas control valve to OFF position, and turn the gas cylinder valve to the OFF position.
2. Prepare your soapy water solution by combining (1) one part dish washing liquid with (3) three parts water to test for the possibility of any gas leaks in the hose or connections to regulator and the regulator connection to gas cylinder. Apply soapy water solution to the gas cylinder valve, regulator and up the hose to the grill hose connection.
3. Turn gas cylinder valve ON (gas control valve is in the OFF position) and observe gas cylinder valve, hose and regulator for bubbles. **DO NOT LEAVE GAS ON FOR MORE THAN 12 SECONDS.** If bubbles appear, stop, turn gas cylinder OFF, and retighten the fitting. Repeat test.
4. When the test is complete, and there are no leaks, wait a minimum of 5 minutes for gas fumes to diminish before lighting cooker.

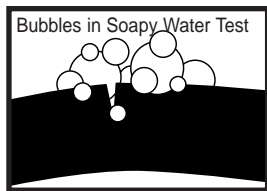

DURING ANY PORTION OF THE SOAPY WATER TEST, IF BUBBLES CONTINUE TO APPEAR, STOP, DO NOT USE THE GRILL AND CONTACT YOUR LOCAL PROPANE DEALER OR MASTERBUILT AT 800-489-1581 NOTE: USE A 20 LB. CYLINDER OR SMALLER WITH A PROTECTIVE COLLAR WITH THIS GRILL.

Before each use perform soapy water test. Before each use, inspect gas hose for any signs of abrasion, cuts, leaks, or wear. If replacement is needed, contact Masterbuilt Manufacturing for regulator hose model #BPRLP19.

BURNER LIGHTING INSTRUCTIONS

1. Read all instructions and warnings before lighting
2. Check the gas control valve and gas cylinder valve to be certain it is in the OFF position before connecting to the gas cylinder. perform soapy water test before each use.
3. Open lid during lighting
4. Turn gas control valve OFF, turn gas cylinder valve on
5. Push down knob and turn to 'ignite' and light
6. Repeat up to three time if necessary
7. If ignition does not take place immediately, wait five minutes and then match light. See match light instructions below.
8. After each use, first turn the gas control valve off first, then the gas cylinder valve off. Always allow grill to cool completely before touching, moving, or storing.

⚠ CAUTION: Fatty foods (like hamburgers) can have excess grease and can cause flare up. When cooking fatty foods, use a low setting with lid open.

MATCH LIGHTING INSTRUCTIONS

1. Read all instructions and warnings before lighting
2. Check the gas control valve and gas cylinder valve to be certain it is in the OFF position before connecting to the gas cylinder. perform soapy water test before each use.
3. Open lid during lighting
4. Turn gas control valve OFF, turn gas cylinder valve on
5. Push down knob and turn to low setting
6. Place a lit fireplace match through lighting hole in side of grill.
7. After each use, first turn the gas control valve off first, then the gas cylinder off. Always allow grill to cool completely before touching, moving, or storing.

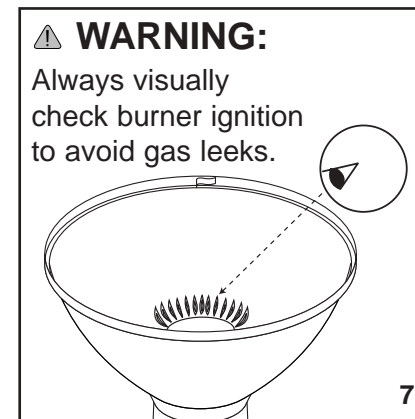

Free Manuals Download Website

<http://myh66.com>

<http://usermanuals.us>

<http://www.somanuals.com>

<http://www.4manuals.cc>

<http://www.manual-lib.com>

<http://www.404manual.com>

<http://www.luxmanual.com>

<http://aubethermostatmanual.com>

Golf course search by state

<http://golfingnear.com>

Email search by domain

<http://emailbydomain.com>

Auto manuals search

<http://auto.somanuals.com>

TV manuals search

<http://tv.somanuals.com>