

## TO PLAY

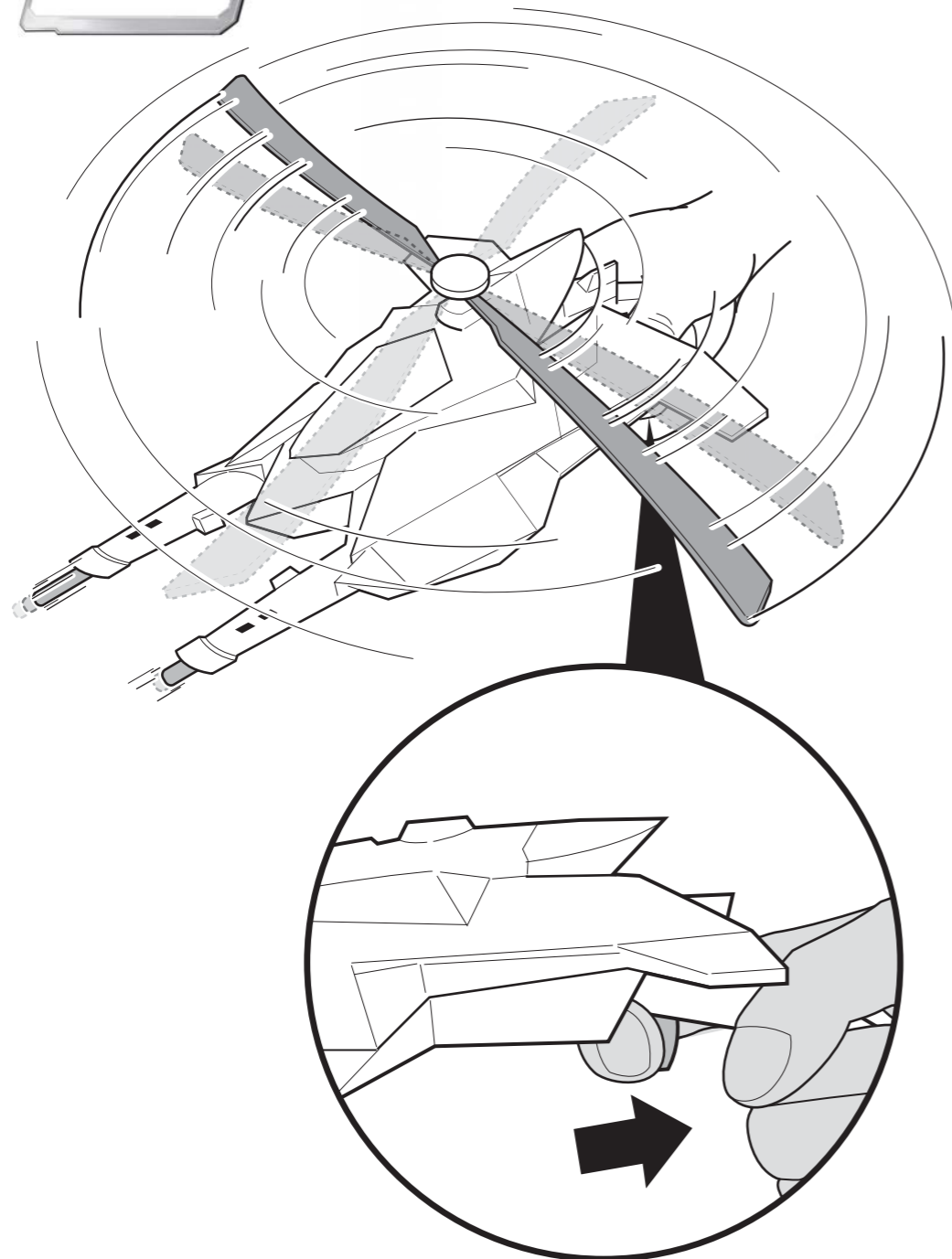

## INSTRUCTIONS

4+

Please keep these instructions for future reference as they contain important information.

## CONTENTS

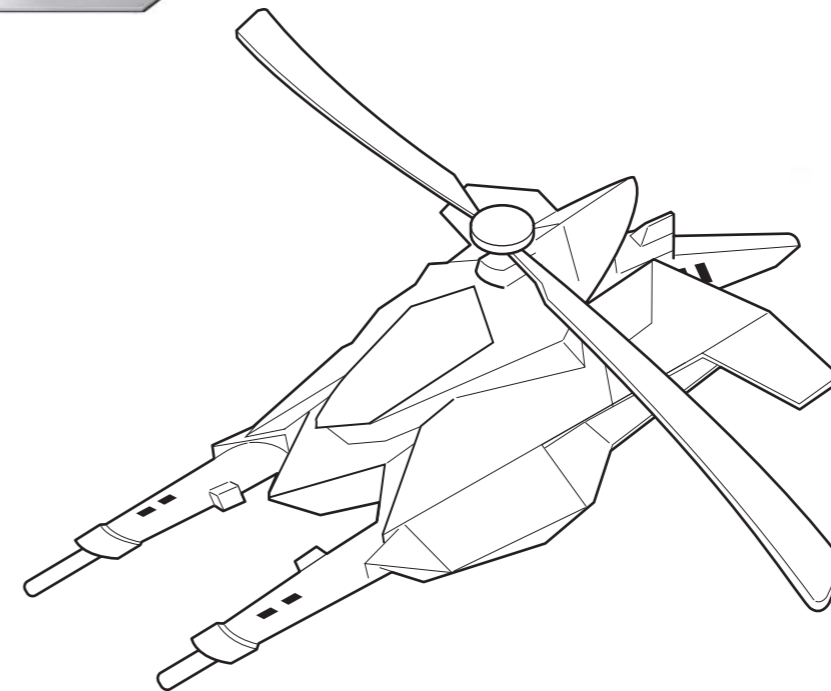

### INSTRUCTION SHEET SPECIFICATIONS

Toy: BM DK HELI JET  
Toy No.: M5071  
Part No.: 0920  
Trim Size: A5  
Folded Size: A6  
Type of Fold: 2  
# colors: One  
Colors: Black  
Paper Stock: White Offset  
Paper Weight: 70 lb.  
EDM No.: \_\_\_\_\_

Mattel, Inc. All Rights Reserved. Mattel, Inc. 333 Continental Blvd., El Segundo, CA 90245 U.S.A. Consumer Relations 1 (800) 524-8697. • Mattel Canada Inc., Mississauga, Ontario L5R 3W2. You may call us free at 1-800-524-8697. • Mattel U.K. Ltd., Vanwall Business Park, Maidenhead SL6 4UB. Helpline 01628500303. • Mattel Australia Pty Ltd., Richmond, Victoria. 3121. Consumer Advisory Service - 1300 135 312. • Mattel East Asia Ltd., Room 1106, South Tower, World Finance Centre, Harbour City, Tsimshatsui, HK, China. • Diimport & Diedarkan Oleh: Mattel SEA Ptd Ltd.(993532-P) Lot 13.5, Menara M5071-0920 Asst. M1110 Lien Hoe, Persiaran Tropicana Golf Country Resort, 47410 PJ. Tel:03-78803817, Fax:03-78803867.



BATMAN and all related characters and elements are trademarks of and © DC Comics. (s08)



service.mattel.com

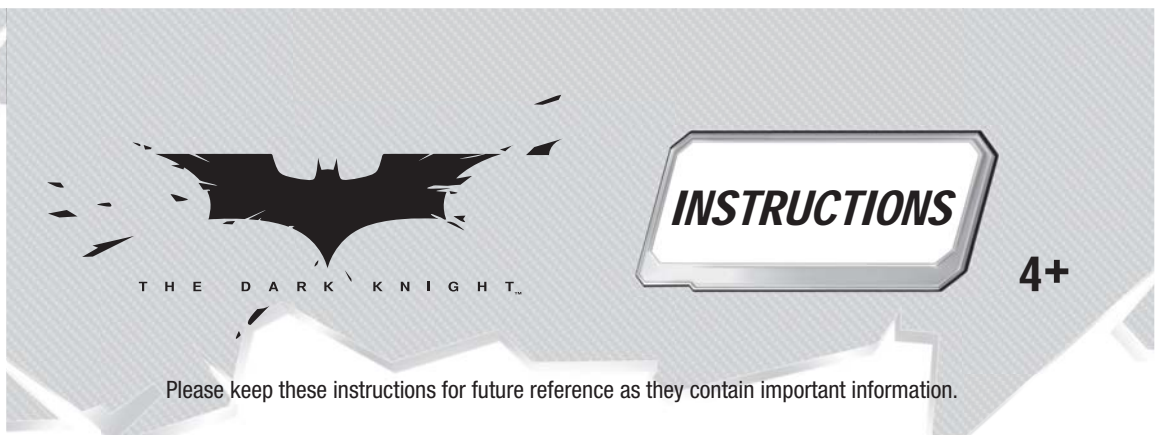

**INSTRUCTION SHEET SPECIFICATIONS**

Toy:	BM DK BAT TRACKER
Toy No.:	M5072
Part No.:	0920
Trim Size:	A4
Folded Size:	A5
Type of Fold:	
# colors:	One
Colors:	Black
Paper Stock:	White Offset
Paper Weight:	70 lb.
EDM No.:	

**3.**

Do not aim at eyes or face.  
Only use projectiles supplied with this toy.  
Do not fire at point blank range.

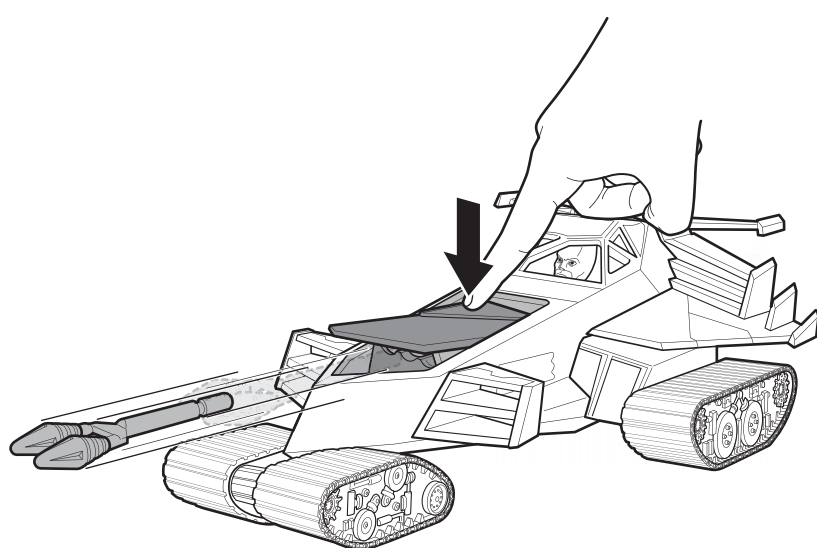

**CONTENTS**

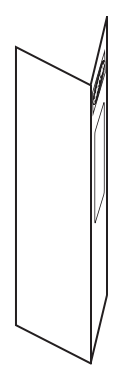
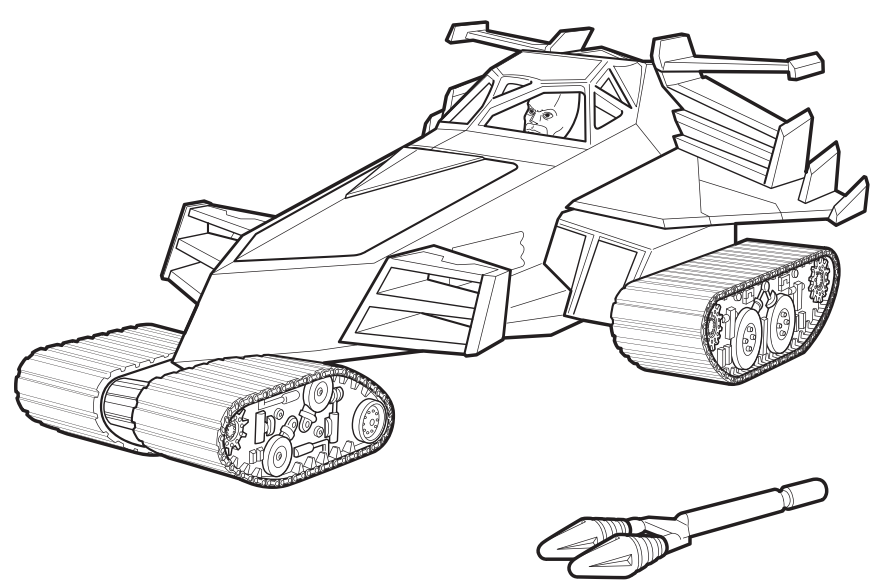

Mattel, Inc. All Rights Reserved. Mattel, Inc., 333 Continental Blvd., El Segundo, CA 90245 U.S.A. Consumer Relations 1 (800) 524-8697.  
 • Mattel Canada Inc., Mississauga, Ontario L5R 3W2. You may call us free at 1-800-524-8697. • Mattel U.K. Ltd., Vanwall Business Park, Maidenhead SL6 4UB, Helpline 01628500303. • Mattel Australia Pty Ltd., Richmond, Victoria, 3121. Consumer Advisory Service - 1300 135 312. • Mattel East Asia Ltd., Room 1106, South Tower, World Finance Centre, Harbour City, Tsimshatsui, HK. M5072 -0920 Asst. M1110  
 China. • Diimport & Diedarkan Oleh: Mattel SEA Ptd Ltd.(993532-P) Lot 13.5, Menara Lien Hoe, Persiaran Tropicana Golf Country Resort, 47410 PJ. Tel:03-78803817, Fax:03-78803867.

BATMAN and all related characters and elements are trademarks of and © DC Comics. (s08)

[service.mattel.com](http://service.mattel.com)

**TO PLAY 1**

**1.**

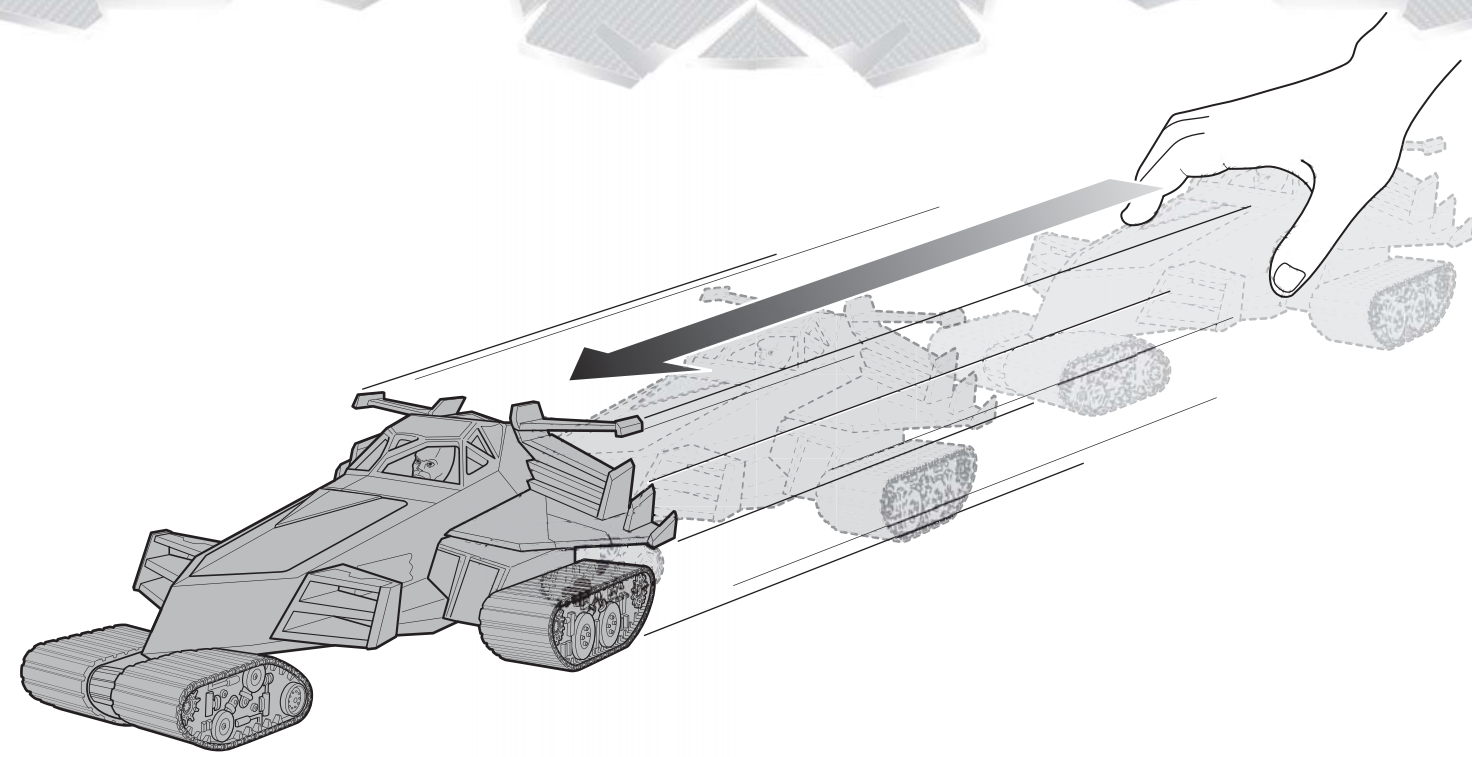

**TO PLAY 2**

**1.**

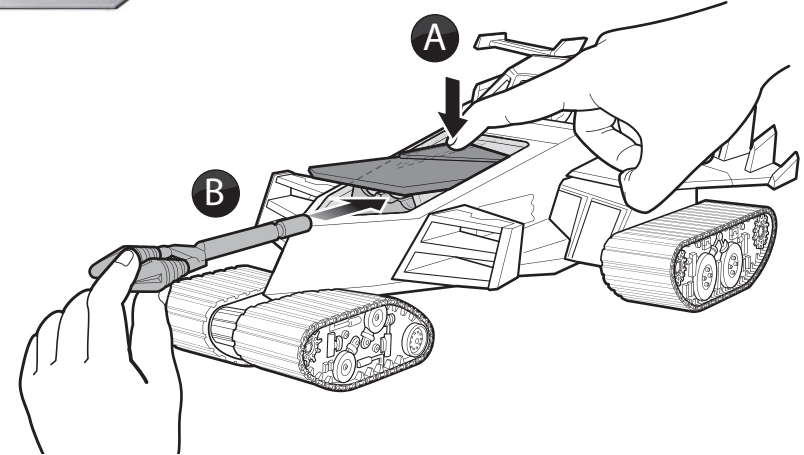

**2.**

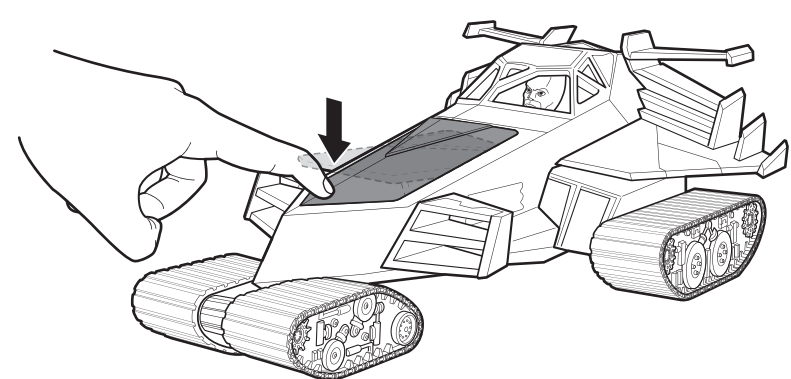



2.

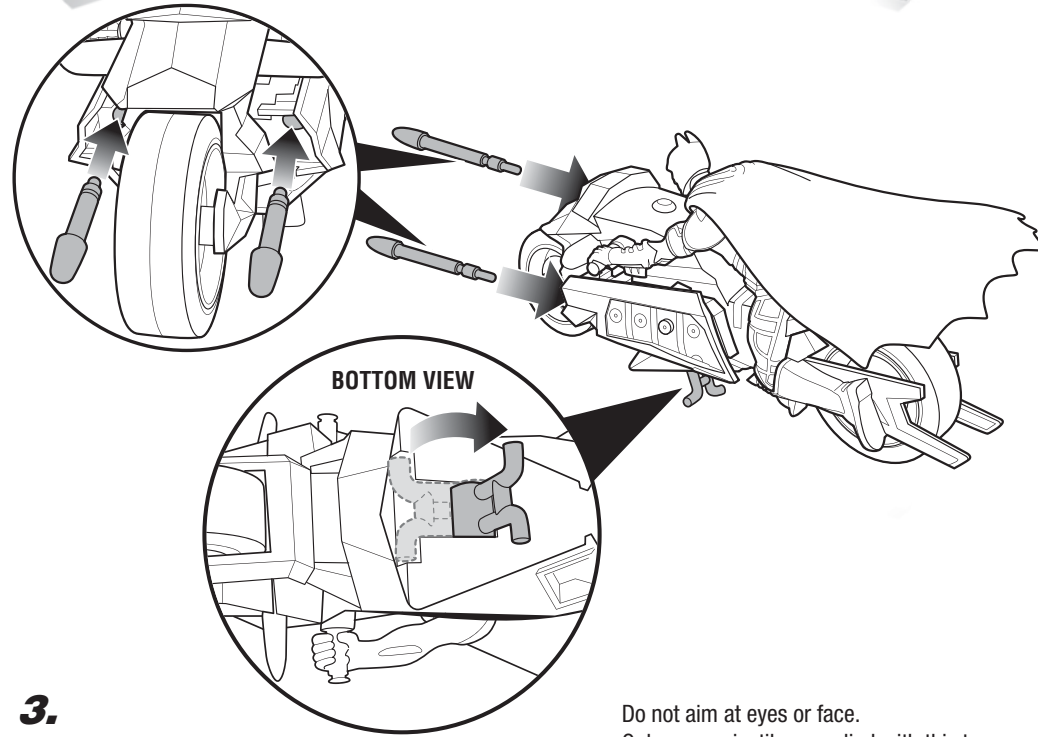

3.

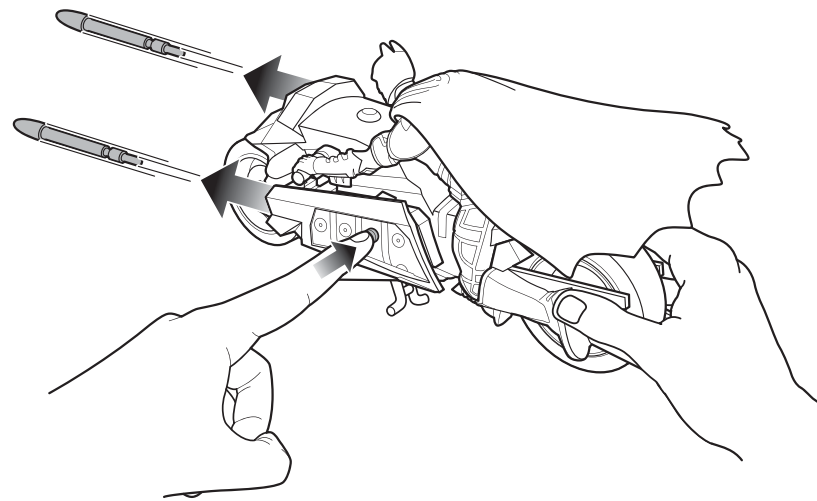

Do not aim at eyes or face.  
Only use projectiles supplied with this toy.  
Do not fire at point blank range.

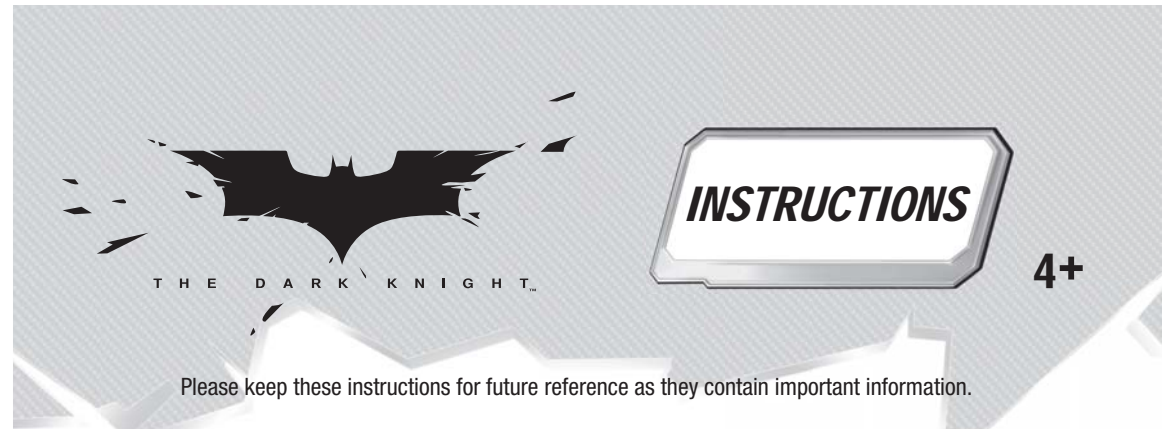

INSTRUCTION SHEET SPECIFICATIONS

Toy:	BM DK PURSUIT CYCLE
Toy No.:	M5073
Part No.:	0920
Trim Size:	A5
Folded Size:	A6
Type of Fold:	
# colors:	One
Colors:	Black
Paper Stock:	White Offset
Paper Weight:	70 lb.
EDM No.:	

CONTENTS

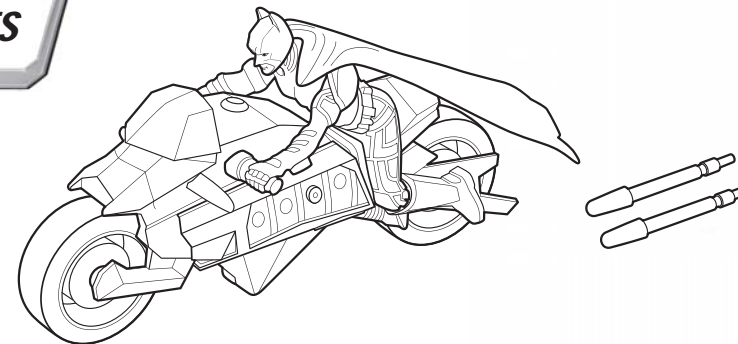

TO PLAY

1.

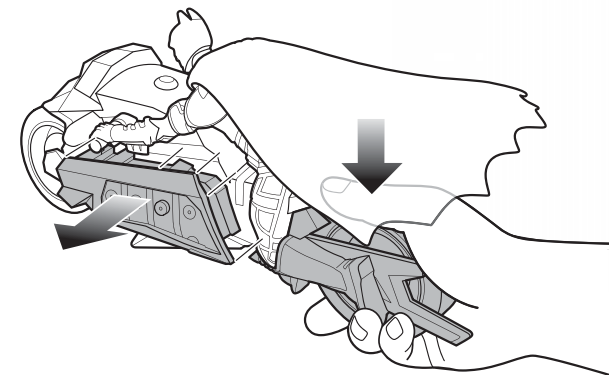

Mattel, Inc. All Rights Reserved. Mattel, Inc, 333 Continental Blvd., El Segundo, CA 90245 U.S.A. Consumer Relations 1 (800) 524-8697.  
 • Mattel Canada Inc., Mississauga, Ontario L5R 3W2. You may call us free at 1-800-524-8697. • Mattel U.K. Ltd., Vanwall Business Park, Maidenhead SL6 4UB, Helpline 01628500303. • Mattel Australia Pty Ltd., Richmond, Victoria. 3121. Consumer Advisory Service - 1300 135 312. • Mattel East Asia Ltd., Room 1106, South Tower, World Finance Centre, Harbour City, Tsimshatsui, HK, M5073-0920  
 China. • Diimport & Diedarkan Oleh: Mattel SEA Ptd Ltd.(993532-P) Lot 13.5, Menara Lien Hoe, Persiaran Tropicana Golf Country Resort, 47410 PJ. Tel:03-78803817, Fax:03-78803867. Asst. M1110



BATMAN and all related characters and elements are trademarks of and © DC Comics.  
(s08)

service.mattel.com



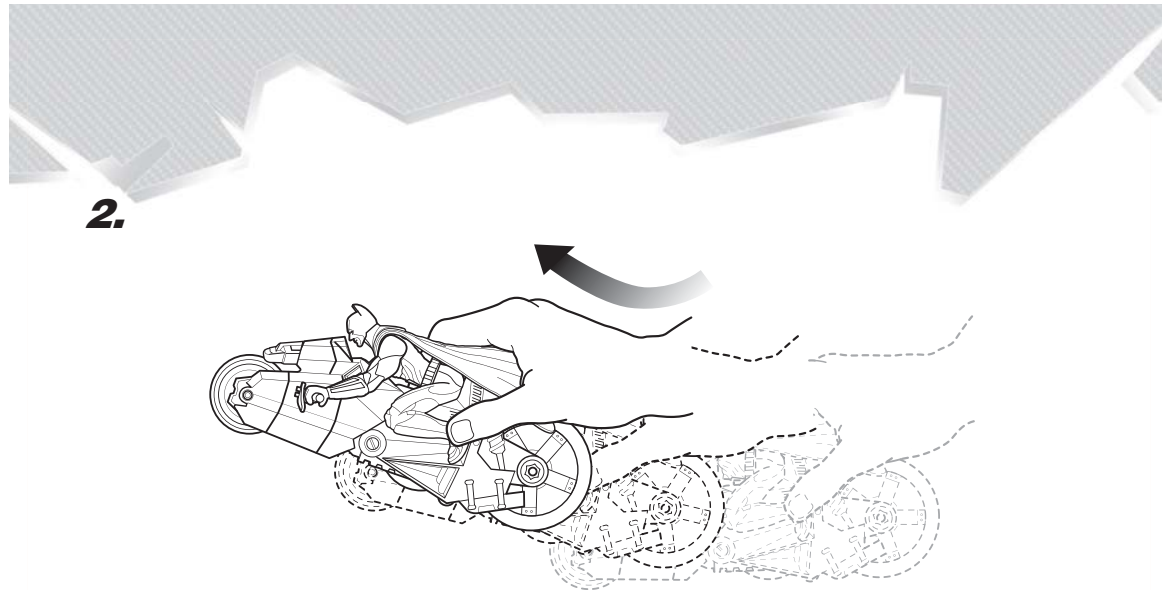

IMPORTANT: Keep fingers away from the rotating rear wheel.

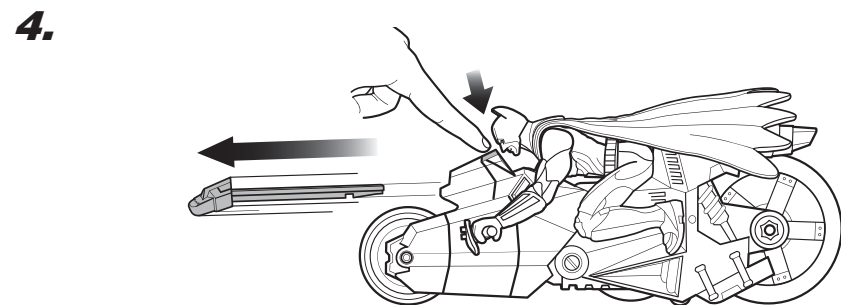
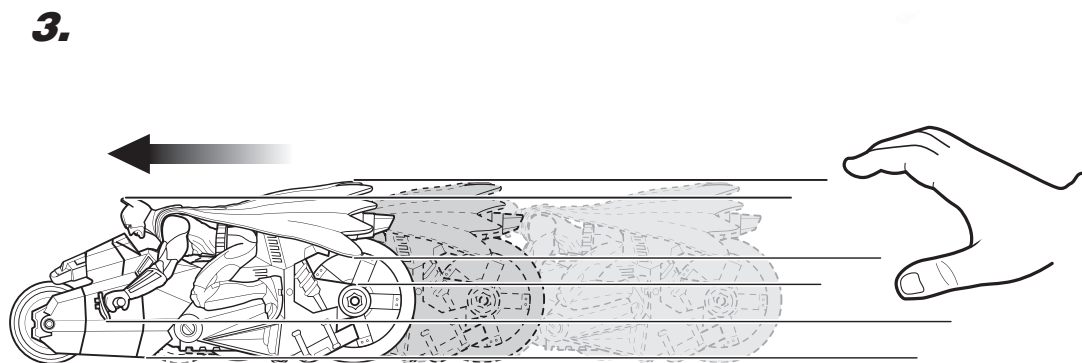

Do not aim at eyes or face.  
Only use projectiles supplied with this toy.  
Do not fire at point blank range.



## CONTENTS

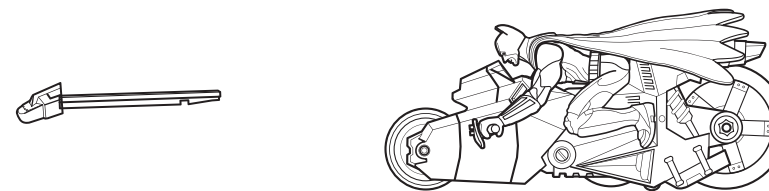

## TO PLAY

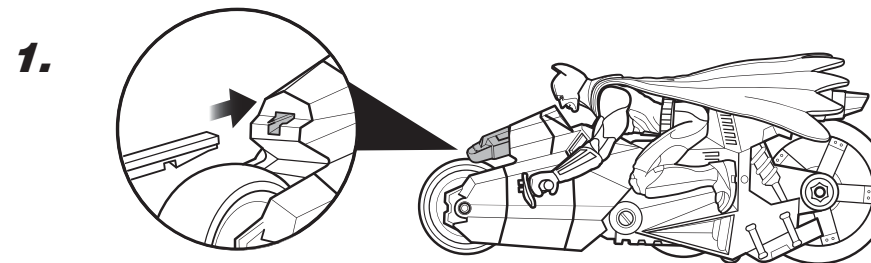

Mattel, Inc. All Rights Reserved. Mattel, Inc. 333 Continental Blvd., El Segundo, CA 90245 U.S.A. Consumer Relations 1 (800) 524-8697.  
 • Mattel Canada Inc., Mississauga, Ontario L5R 3W2. You may call us free at 1-800-524-8697. • Mattel U.K. Ltd., Vanwall Business Park, Maidenhead SL6 4UB, Helpline 01628500303. • Mattel Australia Pty Ltd., Richmond, Victoria. 3121. Consumer Advisory Service - 1300 135 312. • Mattel East Asia Ltd., Room 1106, South Tower, World Finance Centre, Harbour City, Tsimshatsui, HK, China. • Diimport & Diedarkan Oleh: Mattel SEA Ptd Ltd.(993532-P) Lot 13.5, Menara Lien Hoe, Persiaran Tropicana Golf Country Resort, 47410 PJ. Tel:03-78803817, Fax:03-78803867.

BATMAN and all related characters and elements are trademarks of and © DC Comics. (s08)

service.mattel.com



INSTRUCTION SHEET SPECIFICATIONS	
Toy:	BM DK CYCLE
Toy No.:	M9763
Part No.:	0920
Trim Size:	A5
Folded Size:	A6
Type of Fold:	
# colors:	One
Colors:	Black
Paper Stock:	White Offset
Paper Weight:	70 lb.
EDM No.:	

## Free Manuals Download Website

<http://myh66.com>

<http://usermanuals.us>

<http://www.somanuals.com>

<http://www.4manuals.cc>

<http://www.manual-lib.com>

<http://www.404manual.com>

<http://www.luxmanual.com>

<http://aubethermostatmanual.com>

Golf course search by state

<http://golfingnear.com>

Email search by domain

<http://emailbydomain.com>

Auto manuals search

<http://auto.somanuals.com>

TV manuals search

<http://tv.somanuals.com>