

FRONT

17. Carefully pry and lift the car body with the tool to loosen it further.

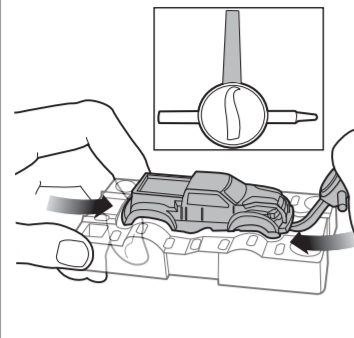

18. Hold firmly and pull the car body completely off the mold.

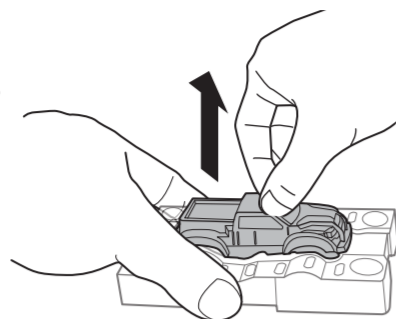

19. Attach car body to a chassis.

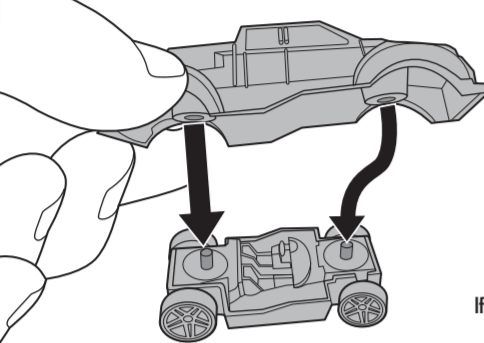

20. Customize with labels.

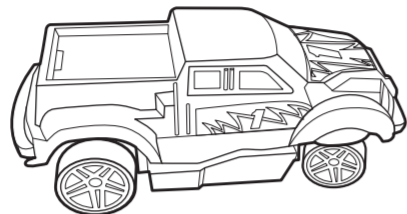

If you need additional help, go to [www.HotWheels.com/CarMaker](http://www.HotWheels.com/CarMaker).

### CLEANING

Remove wax from inside of car mold before next use. **IMPORTANT-** Only use included tool for car making and cleaning.

1.

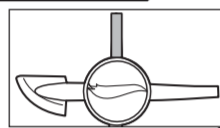

2.

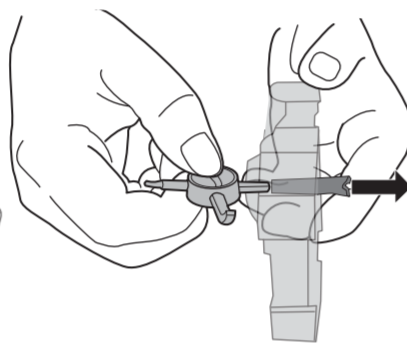

### IMPORTANT INFORMATION:

- Regularly examine the transformer used with this toy for damage to the cord, plug, enclosure, and other parts. In the event of such damage, do not use until damage has been repaired.
- The toy is not intended for children under 3 years old.
- This toy must only be used with a transformer for toys.
- The transformer is not a toy.
- This toy is not to be connected to more than the recommended number of power supplies.
- Toys likely to be cleaned with liquid are to be disconnected from the transformer before cleaning.
- Residual wax from the previous car making cycle may alter the color of the car body.
- Only use Protoshot™ wax sticks supplied with the toy. Do not use other materials.
- Do not use broken wax sticks. They may cause the handle to jam.
- Do not insert wax stick during cooldown cycle. The wax may leak and increase the cooling time.
- If the toy malfunctions, remove the transformer from the wall socket and then plug it in again.

### COMPLIANCE WITH FCC REGULATIONS (VALID IN U.S. ONLY)

This device complies with Part 15 of the FCC Rules.

Operation is subject to the following two conditions:

(1) This device may not cause harmful interference, and (2) this device must accept any interference received, including interference that may cause undesired operation.

• This equipment has been tested and found to comply with the limits for a Class B digital device, pursuant to part 15 of the FCC rules. These limits are designed to provide reasonable protection against harmful interference in a residential installation. This equipment generates, uses and can radiate radio frequency energy and, if not installed and used in accordance with the instructions, may cause harmful interference to radio communications. However, there is no guarantee that interference will not occur in a particular installation. If this equipment does cause harmful interference to radio or television reception, which can be determined by turning the equipment off and on, the user is encouraged to try to correct the interference by one or more of the following measures:

- Reorient or relocate the receiving antenna.
- Increase the separation between the equipment and receiver.
- Connect the equipment into an outlet on a circuit different from that to which the receiver is connected.
- Consult the dealer or an experienced radio/TV technician for help.

NOTE: Changes or modifications not expressly approved by the manufacturer responsible for compliance could void the user's authority to operate the equipment.

### THIS CLASS B DIGITAL APPARATUS COMPLIES WITH CANADIAN ICES-003. CET APPAREIL NUMÉRIQUE DE LA CLASSE B EST CONFORME À LA NORME NMB-003 DU CANADA. (VALID FOR CANADA ONLY • VALABLE AU CANADA SEULEMENT)

Operation is subject to the following two conditions:

(1) this device may not cause interference, and (2) this device must accept any interference, including interference that may cause undesired operation of the device.

L'utilisation de ce dispositif est autorisée seulement aux conditions suivantes :

(1) Il ne doit pas produire de brouillage et (2) il doit pouvoir tolérer tout brouillage radioélectrique reçu, même si ce brouillage est susceptible de compromettre son fonctionnement.



Protect the environment by not disposing of this product with household waste (2002/96/EC). Check your local authority for recycling advice and facilities.



## CAR MAKER

### INSTRUCTIONS

Please keep these instructions for future reference as they contain important information.

### CONTENTS

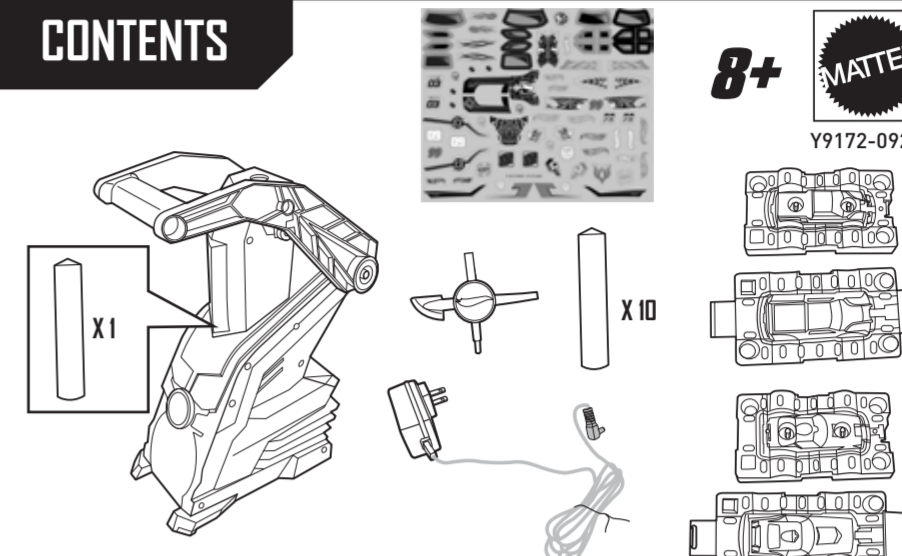

8+



Y9172-0920

### CAUTION: ELECTRIC TOY:

This toy has a heating element, which can result in burns. Not recommended for children under 8 years of age. As with all electric products, precautions should be observed during handling and use to prevent electric shock. Electrical rating – Transformer Input voltage AC: 120V, 50/60 Hz, Output voltage DC: 13.5 V/ 1200 mA. Model No.: PS15B-1351200U.

ADULT SUPERVISION REQUIRED.

©2013 Mattel. All Rights Reserved. Mattel, Inc., 636 Girard Avenue, East Aurora, NY 14052, U.S.A. Consumer Relations 1-800-524-8697. • Mattel U.K. Ltd., Vanwall Business Park, Maidenhead SL6 4UB, Helpline 01628 500303. • Mattel Australia Pty., Ltd., Richmond, Victoria, 3121. Consumer Advisory Service - 1300 135 312. • Mattel East Asia Ltd., Room 1106, South Tower, World Finance Centre, Harbour City, Tsimshatsui, HK, China. • Distributor & Dealer: Mattel SEA Ptd Ltd, (993532-P) Lot 13.5, 13th Floor, Menara Lien Hoe, Persiaran Tropicana Golf Country Resort, 47410 PJ. Tel: 03-78803817, Fax: 03-78803867. service.mattel.com

BACK

### TO PLAY

1. Connect transformer to Car Maker and wall socket.

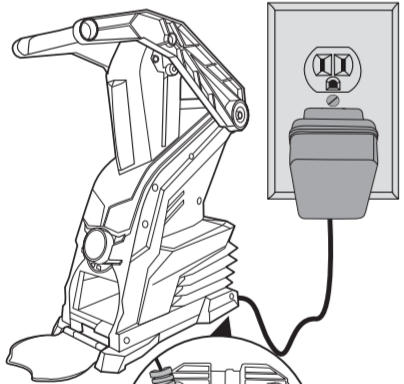

**Note to Adults:** Periodically examine this transformer for damage to the cord, housing or other parts that may result in the risk of fire, electric shock or injury. If the transformer is damaged, do not use it.

Children playing with electrical toys operating at 120 volts should be supervised by an adult.

This transformer is intended to be correctly orientated in a vertical or floor mount position. This toy must only be used with the transformer included.

This product is not recommended for use on loose dirt or wet surfaces.

Do not immerse in water.

BOTTOM VIEW

2. Select a car mold. Align and press together.

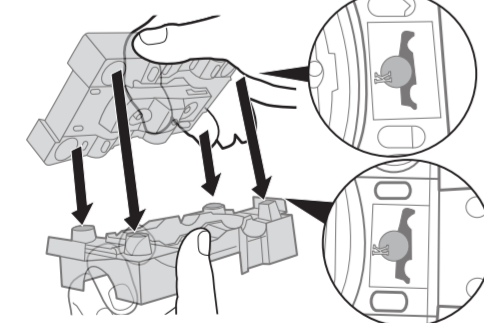

3. Clip both sides to lock mold.

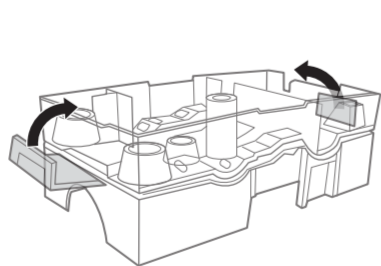

4. Load the mold in the orientation shown. You will hear a "Click" when inserted correctly.

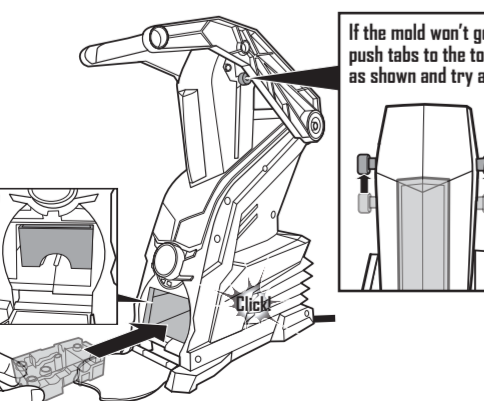

If the mold won't go in, push tabs to the top as shown and try again.

5. Close the door.

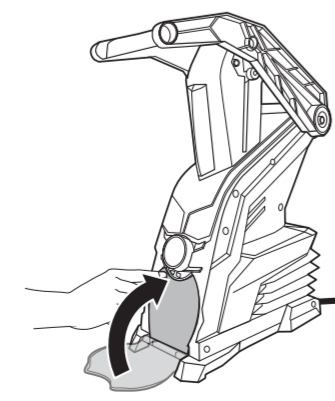

**FOR FIRST USE,** insert 2 wax sticks (Car Maker comes pre-loaded 6. with 1 blue stick). **After that, insert 1 wax stick for each use.**

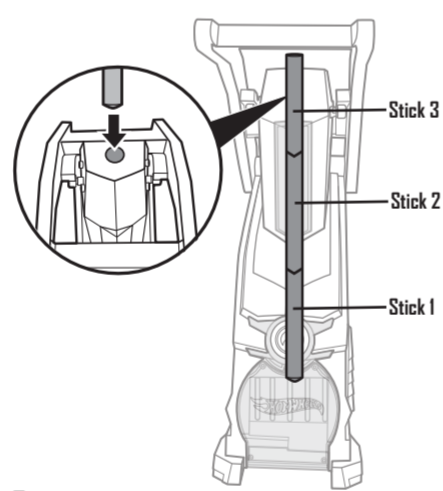

7. Press button to lock the door and begin heating cycle. Heating cycle takes 5-7 minutes. **Note:** Car mold **MUST** be inserted correctly before the door will lock.

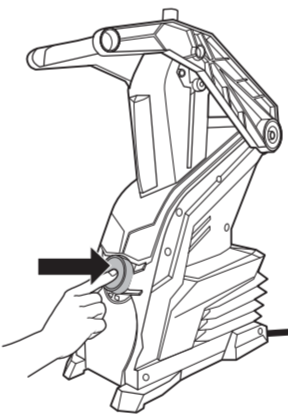

8. When instructed, pull down handle until you hear "complete".

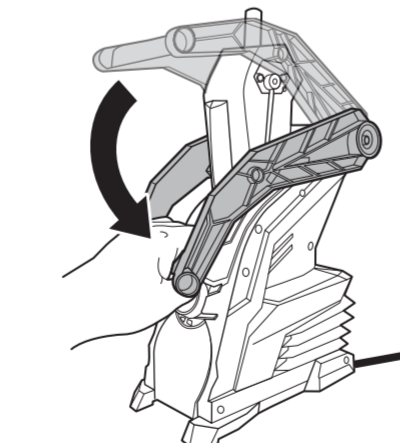

9. Release handle to start cooldown cycle. Completes in 6-7 minutes.

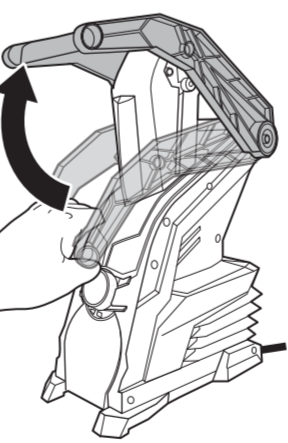

10. When cooldown cycle is complete, the door will unlock. Pull door open.

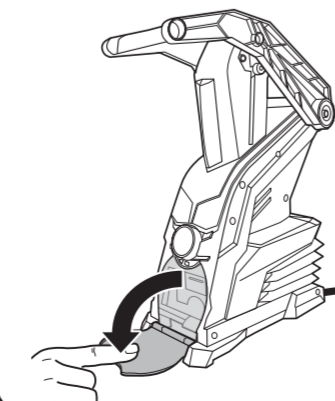

11. Remove the car mold.

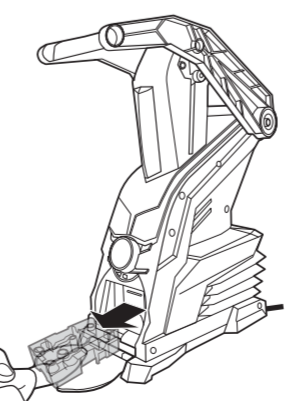

12. Use tool to remove excess wax.

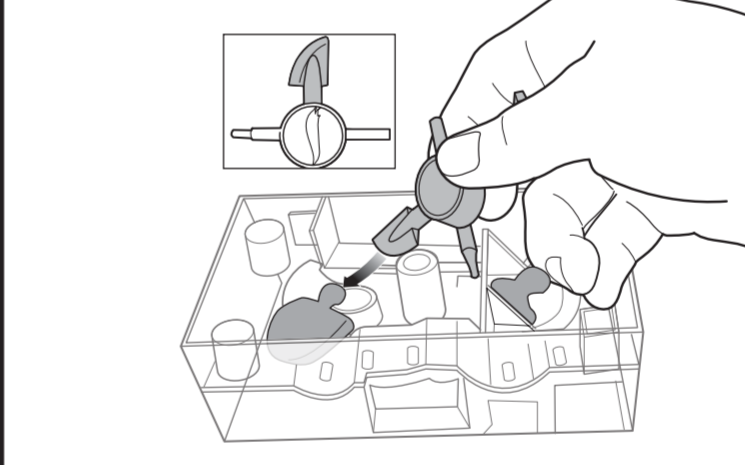

13. Unclip the mold.

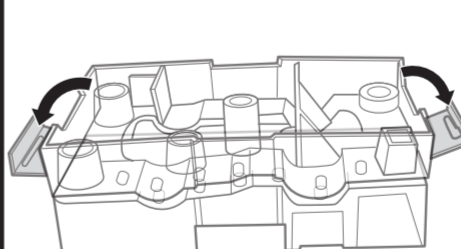

14. Separate the mold.

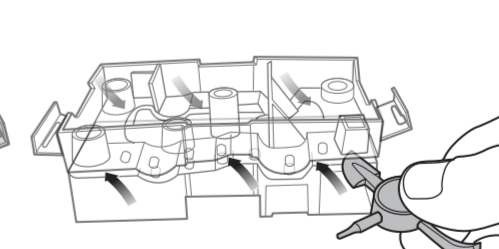

15. Pull the mold apart.

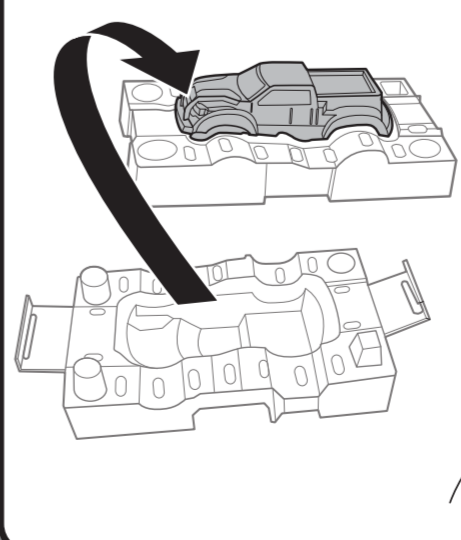

16. Use tool as shown to free the front and back of the car body from the mold.

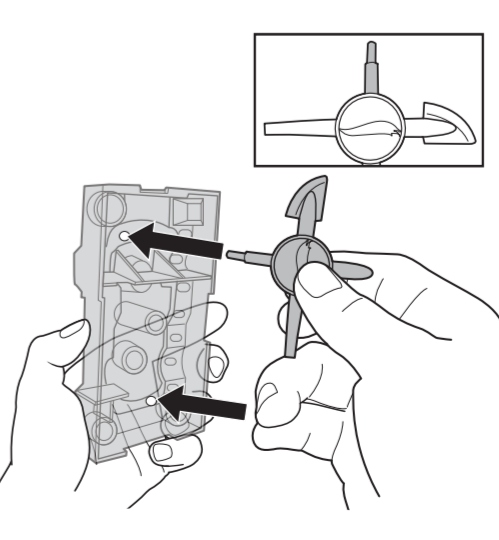

### INSTRUCTION SHEET SPECIFICATIONS

Toy: HW CAR MAKER  
Toy No.: Y9172  
Part No.: 0920  
Trim Size: 16.5" W x 8.5" H  
Folded Size: 5.5" W x 8.5" H  
Type of Fold: Single  
# colors: One  
Colors: Black  
Paper Stock: White Offset  
Paper Weight: 70 lb.  
EDM No.:  
Date: 09/05/2011

### 2 PANEL Folding Dummy

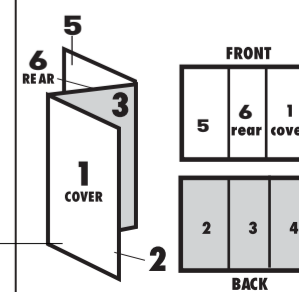

## Free Manuals Download Website

<http://myh66.com>

<http://usermanuals.us>

<http://www.somanuals.com>

<http://www.4manuals.cc>

<http://www.manual-lib.com>

<http://www.404manual.com>

<http://www.luxmanual.com>

<http://aubethermostatmanual.com>

Golf course search by state

<http://golfingnear.com>

Email search by domain

<http://emailbydomain.com>

Auto manuals search

<http://auto.somanuals.com>

TV manuals search

<http://tv.somanuals.com>