

HOW TO PLAY

MATTEL ELECTRONICS® BOWLING

THE ELECTRONIC BOWLING GAME
WITH
WRIST-ACTION
BALL
CONTROL!

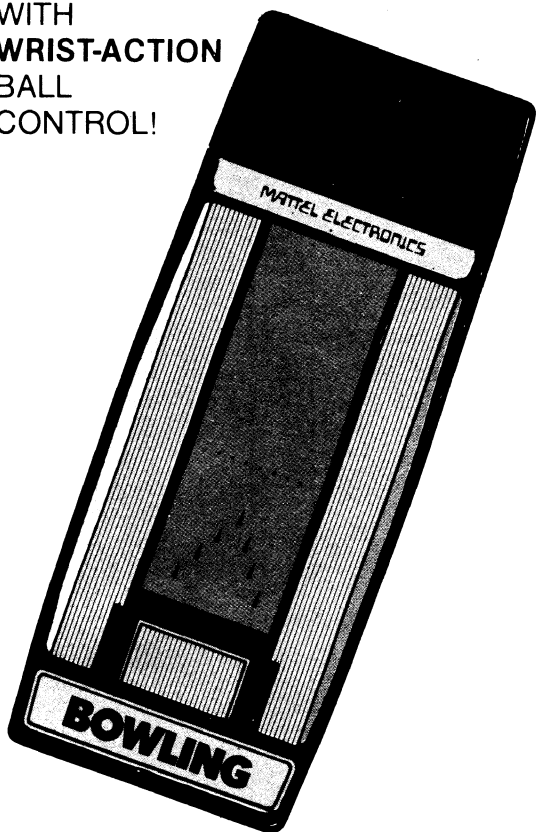

Illustrations: ©Mattel, Inc. 1980. Hawthorne, CA 90250

PRINTED IN HONG KONG. All Rights Reserved.

INSERT BATTERY

Slide open the back cover. Attach one 9-volt battery to the connector. Replace cover. Alkaline battery recommended.

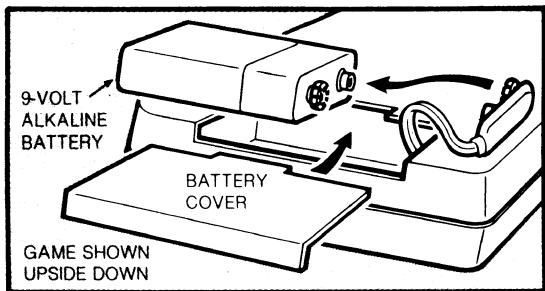

Use a 9-volt Duracell* or other high quality alkaline battery for longer life.

*Trademark of Duracell International, Inc.

TO REMOVE BATTERY

Remove the back cover. Place the edge of the cover between the battery posts and the battery. Pry up gently. Important: Do not pull the plastic wire connector to loosen it.

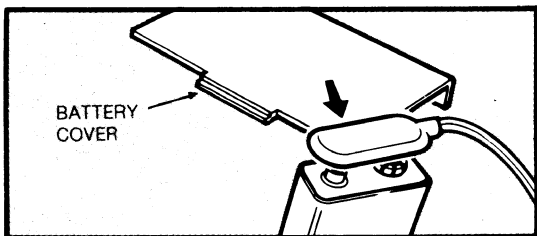

IMPORTANT INFORMATION

If the lights appear to be malfunctioning, this is the first sign of battery wear. A fresh battery should solve the problem.

AC ADAPTOR (OPTIONAL)

You may use a Mattel Electronics® Adapter with this game (sold separately).

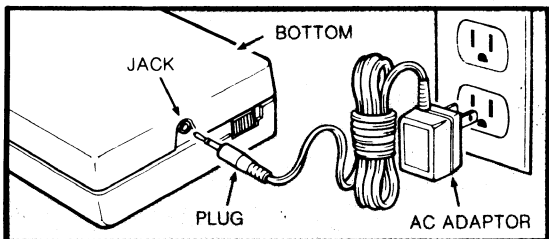

THE CONTROLS

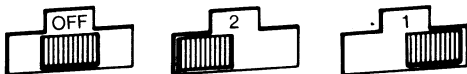

ON/OFF SWITCH SETS NUMBER OF PLAYERS

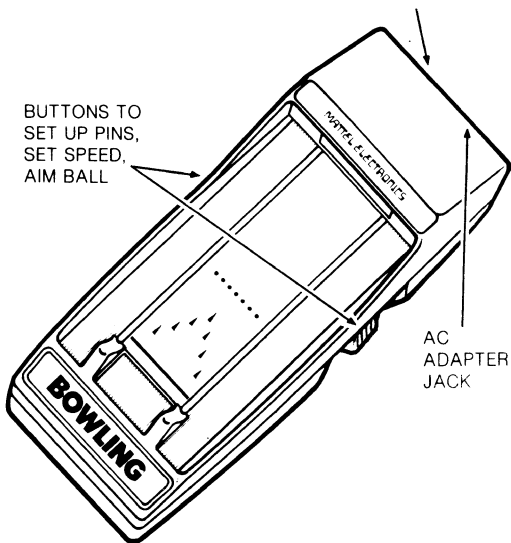

SEVEN SPEED OPTIONS

First, turn on the game by sliding the switch to 1 or 2, for the number of bowlers. The display will be blank. As soon as you touch the side buttons, the display will tell you the game speed, for instance (with digital numbers a "5" looks like an "S"):

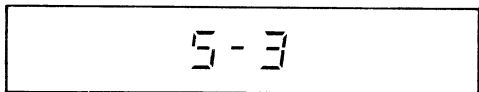

You can change the speed by pressing either side button. As you do this, you'll see the digital display change.

In this game, as in real bowling, speed is not as important as accuracy. You'll probably want to start playing at one of the slower speeds (S-1 is the slowest, S-7 the fastest). NOTE: You set the speed just once, at the beginning of each game.

When you see the speed you want, just **release both buttons**. This control is sensitive, so be careful not to jiggle the game as you release the buttons. A sensor will tell the computer that's the speed you've selected.

HOW TO HOLD THE GAME

There are different ways to hold MATTEL ELECTRONICS® BOWLING. The important thing is to be able to keep a sensitive touch on the side buttons while you're positioning the ball. You also have to be able to tilt the game from side to side for better ball control. Use a grip that's most comfortable for you. Here are three suggested methods:

A

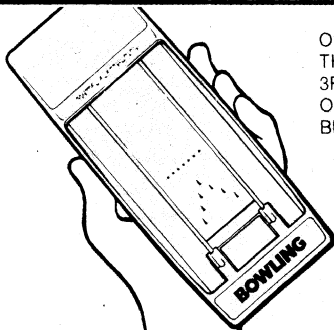

ONE HAND —
THUMB AND
3RD FINGER
ON SIDE
BUTTONS

B

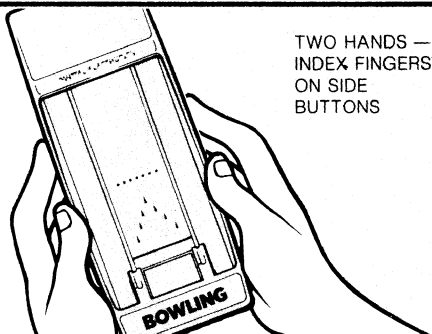

TWO HANDS —
INDEX FINGERS
ON SIDE
BUTTONS

C

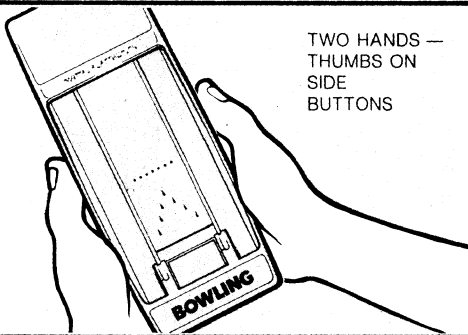

TWO HANDS —
THUMBS ON
SIDE
BUTTONS

HOW TO PLAY

As soon as you've set the speed, the scoreboard flashes a series of numbers:

P	1	FOI	r	000
PLAYER #		FRAME #	MARKS	SCORE

The symbol for "marks" will always be **r** at the start of the game. If you're not familiar with the scoring system for bowling, refer to the next section.

Now place fingers or thumbs on the side buttons and press in. The pins are set up at the far end of the alley. The ball, appearing as a bright light, is at your end. By pressing one side or the other you can move the starting point of the ball from side to side. When you've adjusted the ball's starting position to your liking, release the side buttons. Again, be careful not to jiggle the game as you move your fingers off buttons. The ball will "roll" down the alley.

IF YOU TOUCH EITHER SIDE BUTTON WHILE THE BALL IS MOVING, THAT WILL BE A FOUL, SIGNALLED BY A FALLING TONE. A FOUL MEANS YOU WASTE THAT BALL, AND YOU CAN'T SCORE ANY PINS WITH IT.

If there's no foul, you hear a rising tone as the ball approaches the pins.

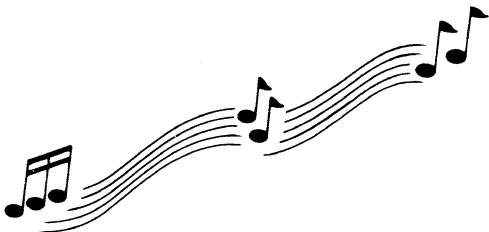

To make the ball curve or hook, tilt the game toward the side where you want it to go. If you tilt too far, the ball will fall into the gutter and you will not, of course, knock down any pins. If you should try to **start** the ball down the gutter after releasing the side buttons, the scoreboard will just recycle through the series of numbers shown earlier.

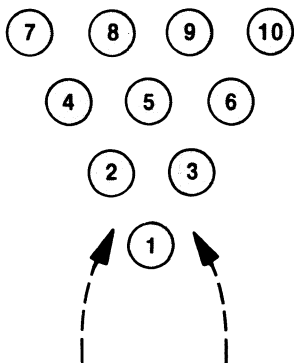

Try to move the game so the ball curves into the "pocket" between the #1 (head pin) and either of the pins behind it, to increase your chance for a strike.

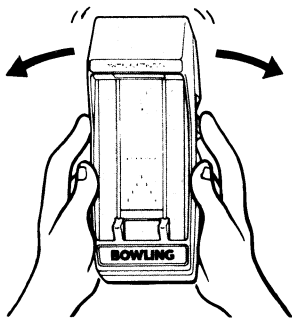

When the ball hits the pins, you hear a short sound for each pin you knock down. Let's assume you get 8 pins with your first ball. You hear 8 of the pin-counting sounds. Then the scoreboard flashes:

08 (pins dropped by that ball)

Player #

Frame #

000 (if you have no marks in the previous frame, your total pins won't be added until this frame is finished)

The "mark" symbol will appear only **before** the first ball of each frame.

If you knock down the remaining two pins with your second ball, you've got a "spare". The #2, #5, and #9 pins will light up, and the scoreboard will show a score of 10 (total pins knocked down in that frame).

When two people play, the scoreboard's first number after each frame shows the results for the bowler who has just had his turn. The sequence continues with the other player's number, frame number, mark symbol and score.

When you get a strike, you hear a short "fanfare" sound — a single series of rising tones.







SCORE KEEPING

There are 10 turns (or "frames") for each player to knock down as many pins as possible. Each player gets two chances to knock down the ten pins. If the bowler fails to knock down all ten pins in both chances, his score for that frame is the total number of pins that **were** knocked down. If the bowler takes both chances to knock down all ten pins, that's a "spare," and the points won in that frame are the ten pins **plus** the number of pins knocked down by the first ball of the following frame (so the most points you could get with a spare would be 20). If the bowler gets all ten pins with the first ball, that's a "strike" — 10 points **plus** all the pins he knocks down with the next two balls. So a strike could mean 30 points. Twelve strikes would be a 300 score — a perfect game!

If you get all the pins down in a frame — called a "mark" whether you made a spare or a strike — your pin total doesn't include your total score until you've actually rolled one or two more balls.

The scoreboard flashes one of these symbols before each player comes up to bowl his first ball of a frame, to tell what "mark" has been made in the previous frame:

-  means **no mark** (you knocked down less than 10 pins with two balls)
-  means a **spare** (you got ten points plus your pins on your next ball)
-  means a **strike** (you got ten points plus your pins on your next two balls)
-  means a **double** (you got two strikes in a row — 20 points plus your pins on your next ball)

Also, when you make a mark some of the pins reappear momentarily, showing the standard symbols for a spare (/) or strike (X):

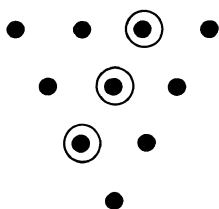

AFTER A SPARE

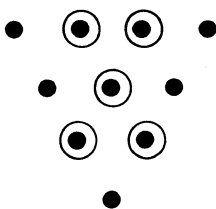

AFTER A STRIKE

11TH AND 12TH FRAMES

If the bowler scores a spare or a strike in the 10th frame, there are opportunities to get extra points by rolling either one or two more balls. The scoreboard will show these bonus chances as Frame 11 and Frame 12.

TAKING CARE OF YOUR GAME

- Treat your BOWLING game with care.
- Don't drop it.
- Don't expose it to heat. For instance, leaving it in the glove compartment of a car on a hot, sunny day could be harmful.
- Avoid getting it wet or dirty.

90-DAY LIMITED WARRANTY

Mattel Electronics warrants to the original consumer purchaser of any of its electronic games (including hand-held electronic games) that the product will be free of defects in material or workmanship for 90 days from the date of purchase.

During this 90-Day Warranty Period, the game will either be repaired or it will be replaced (at our option) without charge to the purchaser, when returned either to the dealer with proof of the date-of-purchase, or when returned prepaid and insured, with proof of the date-of-purchase, to:

Mattel Electronics Repair Center
5150 Rosecrans Avenue.
Hawthorne, California 90250

Units returned without proof of date-of-purchase, or units returned after the 90-Day Warranty Period has expired, will be repaired or replaced (at our option) for a service charge of \$10.00. Payment must be made by check or money order. This non-warranty service will only be available for one year from the date of purchase. All non-warranty units must be returned postage prepaid and insured to MATTEL ELECTRONICS REPAIR CENTER.

This warranty gives you specific legal rights and you may also have other rights which vary from state to state. This warranty does not cover damage resulting from accident, unreasonable use, neglect, unauthorized service or other causes not arising out of defects in material or workmanship.

IF YOU NEED SERVICE FROM MATTEL ELECTRONICS® REPAIR CENTER. . .

it's available during **and** after the 90-day warranty period.

1. **Pack** the product carefully in its original box. If the box is not available, use a strong carton with plenty of newspaper or other padding. Enclose a brief note telling us the specific problem you are having with the unit, and your name and home address. Remove the battery.
2. **Print** this address on the box:
MATTEL ELECTRONICS REPAIR CENTER
5150 ROSECRANS AVENUE
HAWTHORNE, CA 90250
. . . and your return address.
3. **Send** the package by insured parcel post. During the warranty period, enclose proof-of-purchase date. After warranty period has expired, enclose check or money order for \$10.00.

Free Manuals Download Website

<http://myh66.com>

<http://usermanuals.us>

<http://www.somanuals.com>

<http://www.4manuals.cc>

<http://www.manual-lib.com>

<http://www.404manual.com>

<http://www.luxmanual.com>

<http://aubethermostatmanual.com>

Golf course search by state

<http://golfingnear.com>

Email search by domain

<http://emailbydomain.com>

Auto manuals search

<http://auto.somanuals.com>

TV manuals search

<http://tv.somanuals.com>