

Installation and Operating Guide | Warranty

Model Number | ZRY-316 | VCR / DVD Recorder



© Copyright 2005, LG Electronics U.S.A., Inc.





CAUTION
RISK OF ELECTRIC SHOCK
DO NOT OPEN



CAUTION: TO REDUCE THE RISK OF ELECTRIC SHOCK
DO NOT REMOVE COVER (OR BACK)
NO USER-SERVICEABLE PARTS INSIDE
REFER SERVICING TO QUALIFIED SERVICE PERSONNEL.



This lightning flash with arrowhead symbol within an equilateral triangle is intended to alert the user to the presence of uninsulated dangerous voltage within the product's enclosure that may be of sufficient magnitude to constitute a risk of electric shock to persons.



The exclamation point within an equilateral triangle is intended to alert the user to the presence of important operating and maintenance (servicing) instructions in the literature accompanying the product.

WARNING: TO PREVENT FIRE OR ELECTRIC SHOCK HAZARD, DO NOT EXPOSE THIS PRODUCT TO RAIN OR MOISTURE.

WARNING: Do not install this equipment in a confined space such as a bookcase or similar unit.

CLASS 1 LASER PRODUCT
KLASSE 1 LASER PRODUKT
LUOKAN 1 LASER LAITE
KLASS 1 LASER APPARAT
CLASSE 1 PRODUIT LASER

CAUTION:

This product employs a Laser System. To ensure proper use of this product, please read this owner's manual carefully and retain it for future reference. Should the unit require maintenance, contact an authorized service center. Performing controls, adjustments, or carrying out procedures other than those specified herein may result in hazardous radiation exposure. To prevent direct exposure to laser beam, do not try to open the enclosure. Visible laser radiation when open. **DO NOT STARE INTO BEAM.**

CAUTION: The apparatus should not be exposed to water (dripping or splashing) and no objects filled with liquids, such as vases, should be placed on the apparatus.

CAUTION: CLASS 2M VISIBLE AND INVISIBLE LASER RADIATION WHEN OPEN AND INTERLOCKS DEFEATED
DO NOT STARE INTO THE BEAM OR VIEW DIRECTLY WITH OPTICAL INSTRUMENTS

FCC WARNING: This equipment may generate or use radio frequency energy. Changes or modifications to this equipment may cause harmful interference unless the modifications are expressly approved in the instruction manual. The user could lose the authority to operate this equipment if an unauthorized change or modification is made.

REGULATORY INFORMATION: FCC Part 15

This equipment has been tested and found to comply with the limits for a Class B digital device, pursuant to Part 15 of the FCC Rules. These limits are designed to provide reasonable protection against harmful interference when the product is operated in a residential installation. This product generates, uses, and can radiate radio frequency energy and, if not installed and used in accordance with the instruction manual, may cause harmful interference to radio communications. However, there is no guarantee that interference will not occur in a particular installation. If this product does cause harmful interference to radio or television reception, which can be determined by turning the product off and on, the user is encouraged to try to correct the interference by one or more of the following measures:

- Reorient or relocate the receiving antenna.
- Increase the separation between the product and receiver.
- Connect the product into an outlet on a circuit different from that to which the receiver is connected.
- Consult the dealer or an experienced radio/TV technician for help.

FCC COMPLIANCE: The responsible party for this product's compliance is:

Marketed and Distributed by LG Electronics U.S.A., Inc.,
1000 Sylvan Avenue, Englewood Cliffs, NJ.
Phone: 1-201-816-2000.

CAUTION concerning the Power Cord

Most appliances recommend they be placed upon a dedicated circuit;

That is, a single outlet circuit which powers only that appliance and has no additional outlets or branch circuits. Check the specification page of this owner's manual to be certain.

Do not overload wall outlets. Overloaded wall outlets, loose or damaged wall outlets, extension cords, frayed power cords, or damaged or cracked wire insulation are dangerous. Any of these conditions could result in electric shock or fire. Periodically examine the cord of your appliance, and if its appearance indicates damage or deterioration, unplug it, discontinue use of the appliance, and have the cord replaced with an exact replacement part by an authorized servicer.

Protect the power cord from physical or mechanical abuse, such as being twisted, kinked, pinched, closed in a door, or walked upon. Pay particular attention to plugs, wall outlets, and the point where the cord exits the appliance.

SERIAL NUMBER:

You can find the serial number on the back of the unit. This number is unique to this unit and not available to others. You should record requested information here and retain this guide as a permanent record of your purchase.

Model No. _____

Serial No. _____

IMPORTANT SAFETY INSTRUCTIONS

CAUTION: PLEASE READ AND OBSERVE ALL WARNINGS AND INSTRUCTIONS IN THIS OWNER'S MANUAL. AND THOSE MARKED ON THE PRODUCT. RETAIN THIS BOOKLET FOR FUTURE REFERENCE.

This product has been designed and manufactured to assure personal safety. Improper use can result in electric shock or fire hazard. The safeguards incorporated in this product will protect you if you observe the following procedures for installation, use, and servicing.

This product does not contain any parts that can be repaired by the user.

DO NOT REMOVE THE CABINET COVER, OR YOU MAY BE EXPOSED TO DANGEROUS VOLTAGE. REFER SERVICING TO QUALIFIED SERVICE PERSONNEL ONLY.

- 1. Read these instructions.** - All these safety and operating instructions should be read before the product is operated.
- 2. Keep these instructions.** - The safety, operating and use instructions should be retained for future reference.
- 3. Heed all warnings.** - All warnings on the product and in the operating instructions should be adhered to.
- 4. Follow all instructions.** - All operating and use instructions should be followed.
- 5. Do not use this product near water.** - For example: near a bath tub, wash bowl, kitchen sink, laundry tub, in a wet basement; or near a swimming pool; and other areas located near water.
- 6. Clean only with dry cloth.** - Unplug this product from the wall outlet before cleaning. Do not use liquid cleaners.
- 7. Do not block any ventilation openings. Install in accordance with the manufacturer's instructions.** - Slots and openings in the cabinet are provided for ventilation and to ensure reliable operation of the product and to protect it from over-heating. The openings should never be blocked by placing the product on a bed, sofa, rug or other similar surface. This product should not be placed in a built-in installation such as a bookcase or rack unless proper ventilation is provided or the manufacturer's instructions have been adhered to.
- 8. Do not install near any heat sources such as radiators, heat registers, stoves, or other apparatus (including amplifiers) that produce heat.**
- 9. Do not defeat the safety purpose of the polarized or grounding-type plug.** A polarized plug has two blades with one wider than the other. A grounding type plug has two blades and a third grounding prong. The wide blade or the third prong are provided for your safety. If the provided plug does not fit into your outlet, consult an electrician for replacement of the obsolete outlet.
- 10. Protect the power cord from being walked on or pinched particularly at plugs, convenience receptacles, and the point where they exit from the product.**
- 11. Only use attachments/accessories specified by the manufacturer.**
- 12. Use only with the cart, stand, tripod, bracket, or table specified by the manufacturer, or sold with apparatus. When a cart is used, use caution when moving the cart/product combination to avoid injury from tip-over.**
- 13. Unplug this product during lightning storms or when unused for long periods of time.**
- 14. Refer all servicing to qualified service personnel. Servicing is required when the product has been damaged in any way, such as power-supply cord or plug is damaged, liquid has been spilled or objects have fallen into the product, the product has been exposed to rain or moisture, does not operate normally, or has been dropped.**



INTRODUCTION

Symbol Used in this Manual	6
About the \emptyset Symbol Display	6
Notes on Discs	6
Moisture Condensation	6
Recordable and Playable Discs	7
Recommended recordable DVD discs	7
Playable Discs	8
Regional code of the recorder and DVDs	8
Restrictions on video recording	9
What is 'CPRM'?	9
Copyright	9
Notice for Progressive Scan Use	9
Disc-related terms	10
About the Remote Control	10
Front Panel	11
Function Display Window	12
Remote Control	13
Rear Panel	14

HOOKUP AND SETTINGS

Connecting an Antenna or Cable TV	15
Connections to your TV	15-16
Connection to an Amplifier	16-17
Initial Settings	18-24
General Operation	18
General Settings	18-20
• Tuning Band Select	18
• Auto Channel Set	18
• To Add or Erase Channels from Memory	18
• Clock Set	19
• TV Aspect	19
• Display Mode	19
• Progressive Scan	20
• Power Save Mode	20
• Factory Set	20
Language Settings	20
• Display Menu	20
• Disc Menu/Audio/Subtitle	20
Audio Settings	21
• Dolby Digital/DTS/MPEG	21
• Sampling Freq. (Frequency)	21
• DRC (Dynamic Range Control)	21
• Vocal	21
LOCK (Parental Control) Settings	22
• Rating	22
• Set Password	22
• Area Code (Country Code)	22
Recording Settings	23
• Disc Record Mode	23
• VCR Record Mode	23
• Record Aspect	23
• Auto Chapter	23

Disc Settings	23-24
• Initialize	23
• Finalize	24
• Disc Label	24
• Disc Protect	24
• Auto Play	24

General Explanation of On-Screen

Display	25
Displaying Information While Watching TV	25
Changing TV Audio Channel	25
Displaying Disc Information On-screen	25

PLAYBACK

VCR Tape Playback	26-27
Basic Instructions	26
Auto Tracking	26
Manual Tracking	26
Search	26
Still Picture and Frame-by Frame Playback	26
Slow Motion	26
Counter Memory Function	27
S-VHS Quasi Playback (SQPB)	27
Playing a DVD	27-29
Playback Setup	27-29
• Moving to another TITLE	27
• Moving to another CHAPTER	27
• Slow motion	27
• Search	27
• Time Search	28
• Marker Search	28
• Play mode select	28
• Still Picture and Frame-by-Frame Playback	28
• Zoom	28
• Repeat A-B	29
• Title Menu	29
• Disc Menu	29
• Camera Angle	29
• Subtitles	29
• Changing the Audio Soundtrack	29
• Changing the Audio Channel	29
• 3D Surround	29
• Last Scene Memory	29
Playing an Audio CD or MP3/WMA files	30
Audio CD and MP3/WMA file Features	30
• Pause	30
• Moving to another Track	30
• Play mode select	30
• Repeat A-B	30
• Search	30
Program Playback with Audio CD and MP3/WMA files	31
Notes on MP3/WMA Recordings	31
Viewing a JPEG File	32

RECORDING

About DVD recording33
Disc types and recording formats, modes, and settings33
Notes for recording33
Basic Recording from a TV34
Instant Timer Recording34
Checking the Recording Time34
To Extend the Recording Time34
To Pause the Recording34
To record one TV program while watching another35
Timer Recording35-36
Checking Timer Recording Details35
Canceling a Timer Recording35
Timer Recording Troubleshooting36
Additional Information36
Dubbing from DVD to VCR36
Dubbing from VCR to DVD37
Recording from External Components37

EDITING

Title List and Chapter List Menu Overview38
VR Mode: Original and Playlist Editing39
Titles, Chapters and Parts39
Is editing a DVD like editing a video tape?39
About words 'Original' and 'Playlist'39
Adding Chapter Markers39
Changing Title Thumbnails39
Making a New Playlist40
Adding Additional Title / Chapters to the Playlist40
Deleting an Original or Playlist Title / Chapter41
Deleting a Part41
Naming a Title42
Moving a Playlist Chapter42
Divide One Titles Into Two43
Combining Two Chapters Into One43
Hide a Chapter44
Protect a Title44
Overwriting Recording45
Viewing Title list menu displayed on other DVD Recorders or Players45
Playing Your Recordings on Other DVD Players (Finalizing a Disc)45

REFERENCE

Controlling Your TV with the Supplied Remote Control46
Language Codes47
Area Codes (Country Codes)47
Troubleshooting48-50
Reset the Recorder50
Specifications51-52

Introduction

To ensure proper use of this product, please read this owner's manual carefully and retain for future reference.

Symbol Used in this Manual



Indicates hazards likely to cause harm to the unit itself or other material damage.

Note: Indicates special notes and operating features.

Tip: Indicates tips and hints for making the task easier.

A section whose title has one of the following symbols are applicable only to those discs represented by the symbol.

- RW_{VR}** DVD-RW with VR recording mode
- RW_{Video}** DVD-RW with Video recording mode
- +RW** DVD+RW disc
- R** DVD-R disc
- +R** DVD+R disc
- DVD** DVD-Video disc
- ACD** Audio CDs
- MP3** MP3 files
- WMA** WMA files
- JPEG** JPEG files

About the Symbol Display

"" may appear on your TV display during operation and indicates that the function is not permitted by this unit or the disc.

Notes on Discs

Handling Discs

Do not touch the playback side of the disc. Hold the disc by the edges so that fingerprints do not get on the surface. Never stick paper or tape on the disc.



Storing Discs

After playing, store the disc in its case. Do not expose the disc to direct sunlight or sources of heat and never leave it in a parked car exposed to direct sunlight.

Cleaning Discs

Fingerprints and dust on the disc can cause poor picture quality and sound distortion. Before playing, clean the disc with a clean cloth. Wipe the disc from the center out.

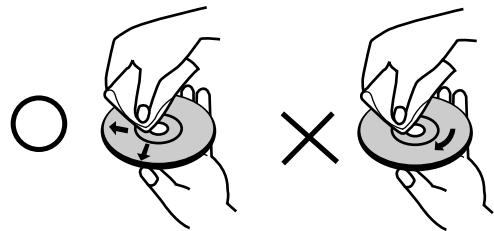

Do not use strong solvents such as alcohol, benzene, thinner, commercially available cleaners, or anti-static spray intended for older vinyl records.

Moisture Condensation

Never operate this product immediately after moving it from a cold location to a warm location. Leave it for two or three hours without operating it. If you use this product in such a situation, it may damage discs/tapes and internal parts.

Recordable and Playable Discs



DVD-RW (DVD - ReWritable)

- DVD-RW discs can be formatted for VR mode recording or Video mode recording.
- These Discs can be recorded on repeatedly. Recordings can be erased, then you can record again on the same Disc.

[VR mode]

- Recordings can be extensively edited
- Playable only on VR mode compatible players (after finalization)

[Video mode]

- Playable on regular DVD players (after finalization)
- Limited editing features



DVD-R (DVD - Recordable)

- These Discs can be recorded only once. After you finalize a DVD-R, you cannot record on it or edit it.
- DVD-R discs can be only formatted to Video mode.
- Playable on regular DVD players (after finalization)
- Limited editing features



DVD+RW (DVD+ ReWritable)

- These Discs can be recorded on repeatedly. Recordings can be erased, then you can record again on the same Disc.
- Playable on DVD+RW compatible players (automatically finalization)
- The edited contents are playable on DVD+RW compatible players only after finalization.
- Recordings can be edited the title/chapter



DVD+R (DVD + Recordable)

- These Discs can be recorded only once. After you finalize a DVD+R, you cannot record on it or edit it any more.
- Playable on DVD+R compatible players (after finalization)
- Any edited contents are not be compatible on DVD+R compatible players. (Hide, chapter combine, added chapter mark, etc.)
- Limited title/chapter editing features.

Recommended recordable DVD discs

DVD-R	DVD+R	DVD-RW	DVD+RW
SONY (8x, 16x)	SONY (2.4x, 4x, 8x, 16x)	Victor (1x, 4x)	SONY (2.4x)
TDK (4x, 8x)	TDK (4x)	Maxell (1x, 2x, 4x)	TDK (2.4x)
Verbatim (4x, 8x)	Mitsubishi (4x, 8x)	VerbatimTDK (2x)	Ricoh (2.4x)
Panasonic (2x, 4x)	Ricoh (2x, 4x, 8x)	Mitsubishi (2x)	HP (2.4x, 4x)
-	-	-	Philips (4x)

Playable Discs



DVD (8 cm / 12 cm disc)

- Discs such as movies that can be purchased or rented
-



Audio CD (8 cm / 12 cm disc)

- Music CDs or CD-Rs/CD-RWs in music CD format that can be purchased
-



CD-R/CD-RW (8 cm / 12 cm disc)

- CD-R/CD-RW discs that contain audio titles, MP3, WMA or JPEG files.
-

Notes:

- Depending on the conditions of the recording equipment or the CD-R/RW (or DVD±R/RW) disc itself, some CD-R/RW (or DVD±R/RW) discs cannot be played on the unit.
- Do not attach any seal or label to either side (the labeled side or the recorded side) of a disc.
- Do not use irregularly shaped CDs (e.g., heart-shaped or octagonal). Doing so may result in malfunctions.
- Depending on the recording software & the finalization, some recorded discs (CD-R/RW or DVD±R/RW) may not be playable.
- DVD-R/RW, DVD+R/RW and CD-R/RW discs recorded using a personal computer or a DVD or CD Recorder may not play if the disc is damaged or dirty, or if there is dirt or condensation on the Recorder's lens.
- If you record a disc using a personal computer, even if it is recorded in a compatible format, there are cases in which it may not play because of the settings of the application software used to create the disc. (Check with the software publisher for more detailed information.)

Region code of the recorder and DVDs



This recorder is designed and manufactured for playback of Region 1 encoded DVD software. The region code on the labels of some DVD discs indicates which type of the recorder can play those discs. This unit can play only DVD discs labeled 1 or ALL. If you try to play any other discs, the message "Incorrect region code. Can't play back" will appear on the TV screen. Some DVD discs may not have a region code label even though their playback is prohibited by area limits.

Notes on DVDs

Some playback operations of DVDs may be intentionally fixed by software manufacturers. As this unit plays DVDs according to disc content designed by the software manufacturer, some playback features of the unit may not be available or other functions may be added.

Refer also to the instructions supplied with the DVDs. Some DVDs made for business purposes may not be played on the unit.

Restrictions on video recording

- You cannot record copy-protected video using this recorder. Copy-protected video includes DVD-Video discs and some satellite broadcasts. If copy-protected material is encountered during a recording, recording will pause or stop automatically and an error message will be displayed on-screen.
- Video that is 'copy-once only' can only be recorded using a DVD-RW disc in VR mode with CPRM (see below).

What is 'CPRM'?

CPRM is a copy protection system (with scramble system) only allowing the recording of 'copy once' broadcast programs. CPRM stands for Content Protection for Recordable Media.

This Recorder is CPRM compatible, which means that you can record copy-once broadcast programs, but you cannot then make a copy of those recordings. CPRM recordings can only be made on DVD-RW discs formatted in VR mode, and CPRM recordings can only be played on players that are specifically compatible with CPRM.

Copyright

- Recording equipment should be used only for lawful copying and you are advised to check carefully what is lawful copying in the area in which you are making a copy. Copying of copyright material such as films or music is unlawful unless permitted by a legal exception or consented to by the rights owner.
- This product incorporates copyright protection technology that is protected by method claims of certain U.S. patents and other intellectual property rights owned by Macrovision Corporation and other rights owners. Use of this copyright protection technology must be authorized by Macrovision Corporation, and is intended for home and other limited viewing uses only, unless otherwise authorized by Macrovision corporation. Reverse engineering or disassembly is prohibited.

Notice for Progressive Scan Use

CONSUMERS SHOULD NOTE THAT NOT ALL HIGH DEFINITION TELEVISION SETS ARE FULLY COMPATIBLE WITH THIS PRODUCT AND MAY CAUSE ARTIFACTS TO BE DISPLAYED IN THE PICTURE. IN CASE OF 525 PROGRESSIVE SCAN PICTURE PROBLEMS, IT IS RECOMMENDED THAT THE USER SWITCH THE CONNECTION TO THE 'STANDARD DEFINITION' OUTPUT. IF THERE ARE QUESTIONS REGARDING YOUR TV SET COMPATIBILITY WITH THIS MODEL 525p DVD+VCR RECORDER, PLEASE CONTACT OUR CUSTOMER SERVICE CENTER.

Disc-related terms

DVD \pm R / DVD \pm RW

DVD -R and DVD +R are two different standards for recordable DVD drives and discs. This format allows information to be recorded onto the DVD disc only once. DVD +RW and DVD -RW are two standards for re-writable media, meaning the DVD content can be erased and re-recorded. Single-sided discs can hold 4.7 GB and double-sided discs hold twice as much.

MP3

MP3 is a popular compression format used for digital audio files that yields very high near-CD quality.

WMA

Windows media audio file. A type of coding / decoding developed by Microsoft Corp.

JPEG

Joint Pictures Expert Group. JPEG is a compressed file format that allows you to save images with no limit on the number of colors.

Title (DVD video discs only)

A title is generally a distinct section of a DVD disc. For example the main feature could be title 1, a documentary describing how the film was made could be title 2, and cast interviews could be title 3. Each title is assigned a reference number enabling you to locate it easily.

Chapter (DVD video discs only)

A chapter is a segment of a title such as a scene in a film or one interview in a series. Each chapter is assigned a chapter number, enabling you to locate the chapter you want. Depending on the disc, chapters may not be recorded.

Track

A distinct element of audiovisual information, such as the picture or sound track for a specific language (DVD), or a musical piece on a video or audio CD. Each track is assigned a track number, enabling you to locate the track you want. DVD discs allow one track of video (with multiple angles) and several tracks of audio.

About the Remote Control

Operation Range

Point the remote control at the remote sensor and press the buttons.

Distance: About 23 ft (7 m) from the front of the remote sensor.

Angle: About 30° in each direction of the front of the remote sensor.

Battery installation

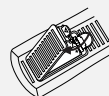

Detach the battery cover on the rear of the remote control, and insert two (R03/AAA) size batteries with \oplus and \ominus aligned correctly.



Do not mix old and new batteries and never mix different types of batteries such as standard, alkaline, etc.

Front Panel

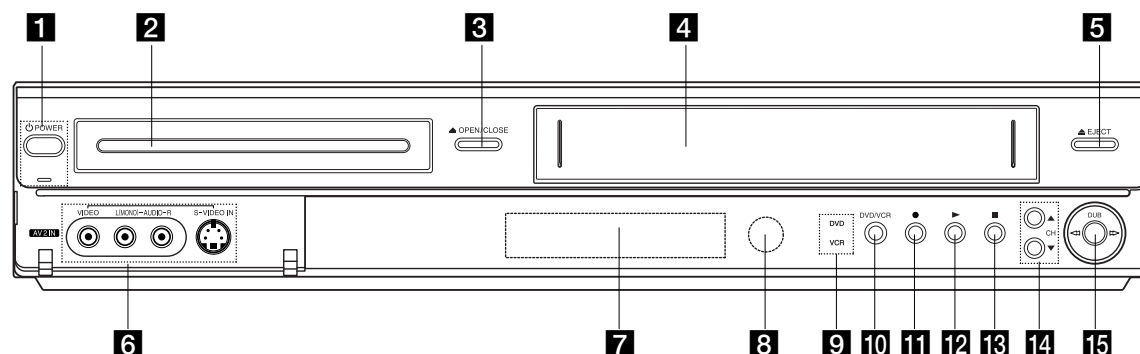

- | | |
|---|--|
| <p>1 POWER button and indicator
Switches the Recorder ON and OFF.
Lights green when the Recorder is turned on.</p> <p>2 Disc Tray (DVD deck)
Insert a disc here.</p> <p>3 ▲ OPEN/CLOSE
Opens or closes the disc tray.</p> <p>4 Cassette Compartment (VCR deck)
Insert a video cassette here.</p> <p>5 ▲ EJECT
Ejects the tape in the VCR deck.</p> <p>6 AV 2 IN
- VIDEO /AUDIO (Left/Right)
Connect the audio/video output of an external source (Audio system, TV/ Monitor, VCR, Camcorder, etc.).
- S-VIDEO IN
Connect the S-Video output of an external source (TV/ Monitor, VCR, Camcorder, etc.).</p> <p>7 Display window
Shows the current status of the Recorder.</p> | <p>8 Remote Sensor
Point the Recorder Remote Control here.</p> <p>9 DVD/VCR indicator
Indicates the active DVD or VCR deck.</p> <p>10 DVD/VCR
Toggles control between the DVD deck and the VCR deck.</p> <p>11 ● (REC) button
Starts recording.
Press repeatedly to set the recording time.</p> <p>12 ► (PLAY)
To play back a disc or tape.</p> <p>13 ■ (STOP)
Stops playback.</p> <p>14 CH (▲ / ▼)
Scans up or down through memorized channels.</p> <p>15 DUB (DUBBING)
Press to copy DVD to VCR (or VCR to DVD).</p> |
|---|--|

LOCK function

The Lock feature disables the front panel buttons to prevent children from tampering with this unit. Simply press LOCK on the remote control to toggle this feature on and off.

Function Display Window

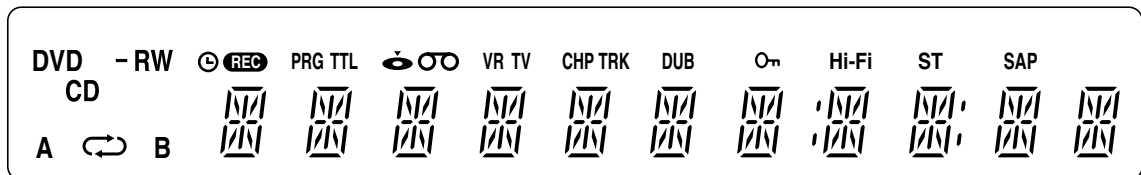

DVD - RW Indicates the type of disc loaded.
CD

A B Indicates repeat mode.

⌚ Indicates when the recorder is in timer recording or a timer recording is programmed.

REC The recorder is recording.

PRG Programmed playback active.

TTL Indicates current title.



A disc is inserted in the DVD deck.



A VHS tape is inserted in the VCR deck.

VR Indicates a DVD-RW disc (VR mode only) is inserted in the DVD deck.

TV Indicates that TV mode is active.

CHP TRK Indicates current chapter or track number

DUB Indicates that a DVD to VCR (or VCR to DVD) dubbing is in progress.

🔒 Indicates when the Recorder is Locked.

Hi-Fi Indicates when the Recorder is playing a tape in Hi-Fi.

ST Indicates a stereo broadcast is being received.

SAP Indicates when a SAP BILINGUAL broadcast is being received.



Indicates clock, total playing time, elapsed time, remaining time, title number, chapter/track number, channel, etc.

Remote Control

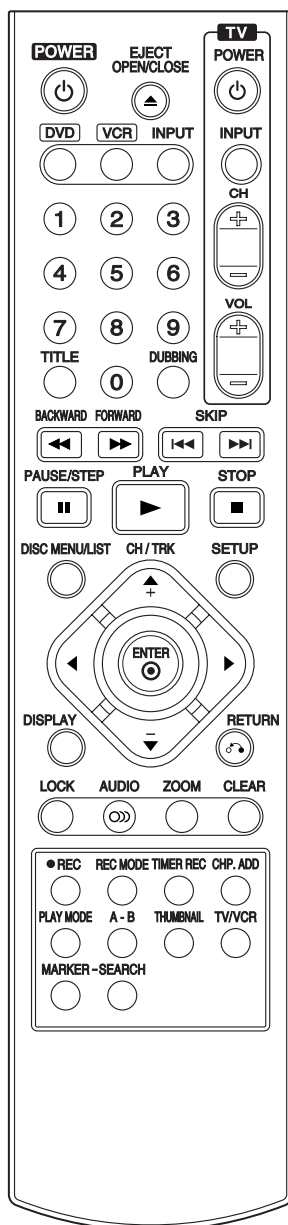

A-B

Repeats sequence between two points (A and B)

AUDIO

Selects an audio language (DVD).

BACKWARD / FORWARD

(◀▶)

- DVD: Search backward or forward.
- VCR: Rewinds/Advances the tape during the STOP mode, for fast reverse/ forward picture search.

CHP. ADD

Inserts a chapter marker when playing/recording.

CH/TRK(▲▼):

Selects a program.
Adjusts manually the tape's picture onscreen.

CLEAR

Removes a mark on the Marker Search menu.

DISC MENU / LIST

Accesses menu on a DVD disc, Title List or Playlist menu.

DISPLAY

Accesses On-Screen Display.
Displays information of current status.

DUBBING

Press to copy DVD to VCR (or VCR to DVD).

DVD

Select the Recorder's function mode to DVD.

EJECT, OPEN/CLOSE

- Opens and closes the disc tray.
- Ejects the tape in the VCR deck.

ENTER (⊙)

Confirms menu selections.

INPUT

Changes the input to use for recording (Tuner, AV1, AV2).

LOCK

Locks/unlocks front panel buttons.

MARKER

Marks any point during playback.

POWER

Turns Recorder ON and OFF.

PAUSE/STEP (II)

Pause playback or recording temporarily.
Press repeatedly for frame-by-frame playback.

PLAY (▶)

Starts playback.

PLAY MODE

Selects play mode.

● REC

Starts recording. Press repeatedly to set the recording time.

REC MODE

Selects the recording mode:
- DVD : SP, LP, EP or XP.
- VCR : SP or SLP.

RETURN (↶)

Removes the menu.

STOP (■)

Stops playback or recording.

SEARCH

Displays Marker Search menu.

SETUP

Accesses or removes the Setup menu.

SKIP (◀◀ / ▶▶)

Go to next chapter or track. Returns to beginning of current chapter or track or go to previous chapter or track.

TITLE

Displays the disc's Title menu, if available.

THUMBNAIL

Selects a thumbnail picture for the current title for use in the Title List or Chapter List menu.

TIMER REC

Displays Timer Record menu.

TV Control Buttons

See page 46.

TV/VCR

To view channels selected by the VCR tuner or by the TV tuner.

VCR

Select the Recorder's function mode to VCR.

ZOOM

Enlarges DVD video image.

0-9 numerical buttons

Selects numbered options in a menu.

◀▶▲▼ (left/right/up/down)

Selects menu options.

LOCK function

The Lock feature disables the front panel buttons to prevent children from tampering with this unit. Simply press LOCK on the remote control to toggle this feature on and off.

Rear Panel

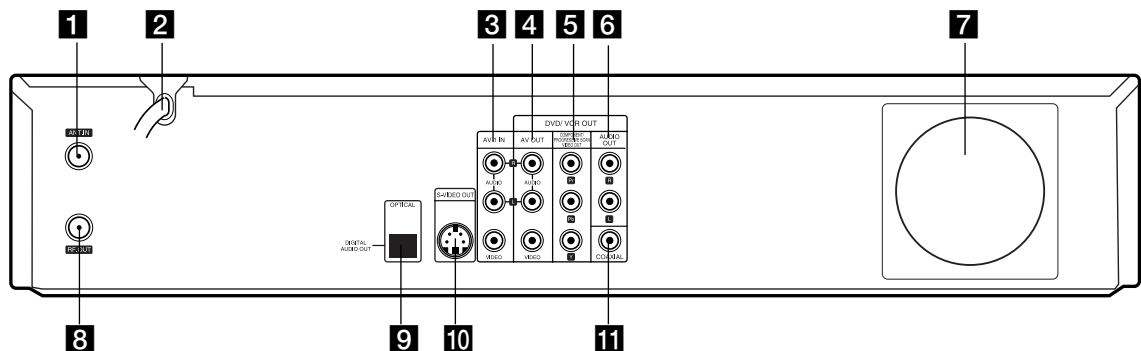

- | | |
|---|--|
| <p>1 ANT.IN
Connect the antenna to this terminal.</p> <p>2 AC Power Cord
Plug into the power source.</p> <p>3 AV 1 IN (VIDEO IN /AUDIO IN (Left/Right))
Connect the audio/video output of an external source (Audio system, TV/Monitor, VCR, Camcorder).</p> <p>4 AV OUT (VIDEO OUT/AUDIO OUT (Left/Right))
Connect to a TV with video and audio inputs.</p> <p>5 COMPONENT/PROGRESSIVE SCAN VIDEO OUT (Y Pb Pr)
Connect to a TV with Y Pb Pr inputs.</p> | <p>6 AUDIO OUT (Left/Right)
Connect to a TV or other equipment with audio inputs.</p> <p>7 Cooling fan</p> <p>8 RF. OUT
Connect to a TV with RF coaxial inputs.</p> <p>9 OPTICAL (DIGITAL AUDIO OUT jack)
Connect to digital (optical) audio equipment.</p> <p>10 S-VIDEO OUT
Connect to a S-Video Input on TV.</p> <p>11 COAXIAL (DIGITAL AUDIO OUT jack)
Connect to digital (coaxial) audio equipment.</p> |
|---|--|

Caution

Do not touch the inner pins of the jacks on the rear panel. Electrostatic discharge may cause permanent damage to the unit.

Hookup and Settings

Depending on your TV and other equipment there are various ways you can connect the recorder. Please refer to the manuals of your TV, VCR, Stereo System or other devices as necessary for additional connection information.

Notes:

- Make sure the Recorder is connected directly to the TV and tune the TV to the correct video input channel.
- Do not connect the Recorder's AUDIO OUT jack to the phono in jack (record deck) of your audio system. Do not connect the Recorder via another VCR. The DVD image could be distorted by the copy protection system.
- The picture and sound of a nearby TV, VCR, or radio may be distorted during playback. Position the units away from each other or turn off the unit after removing the disc.

Connecting an Antenna or Cable TV

1 Antenna:

Disconnect the antenna from the rear of the TV and identify the antenna cable. If it is a round 75 ohm coaxial cable connect it directly to the jack marked ANT.IN on your Recorder. If your antenna cable is flat connect it to a 300-ohm to 75-ohm antenna adaptor (not supplied) and slip the adaptor over the ANT.IN jack. Don't attempt to screw it into the Recorder.

2 Cable TV:

If your cable connection has no converter or descrambler, unscrew the cable from your TV and attach it to the ANT.IN jack on the Recorder. If a converter is required connect a coaxial cable from the wall jack to the IN connector on the converter, and a coaxial cable from the OUT connector on the converter to the ANT.IN on your Recorder. This cable hookup permits both TV and Recorder operation.

To view or record a CATV channel

1. Tune the TV to the Recorder output channel (CH 3 or 4).
2. Set the Recorder channel selector to the cable output channel. (Example: CH3)
3. Select a channel using the cable converter.

Notes:

- With this connection, you cannot record one program while viewing another.
- If you are using a cable box to tune channels, it is not necessary to do Auto Channel Set.

Connections to your TV

Make one of the following connections, depending on the capabilities of your TV.

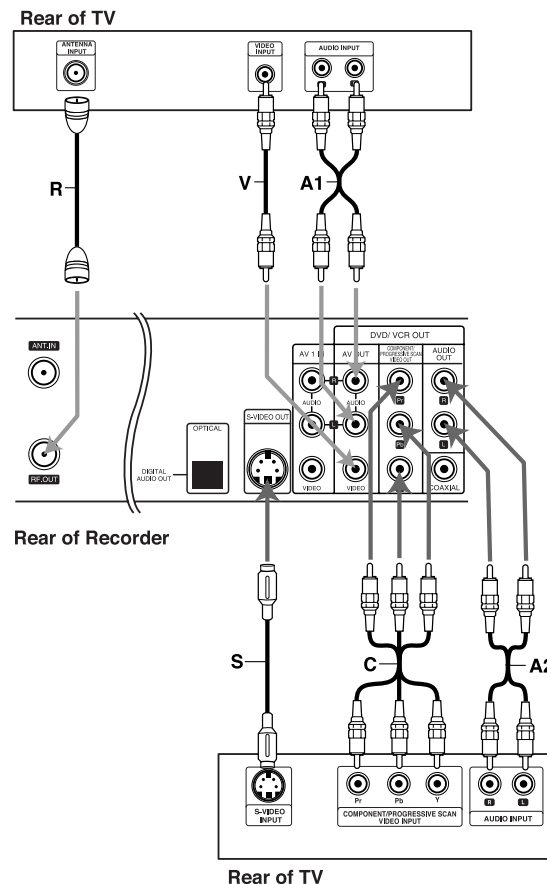
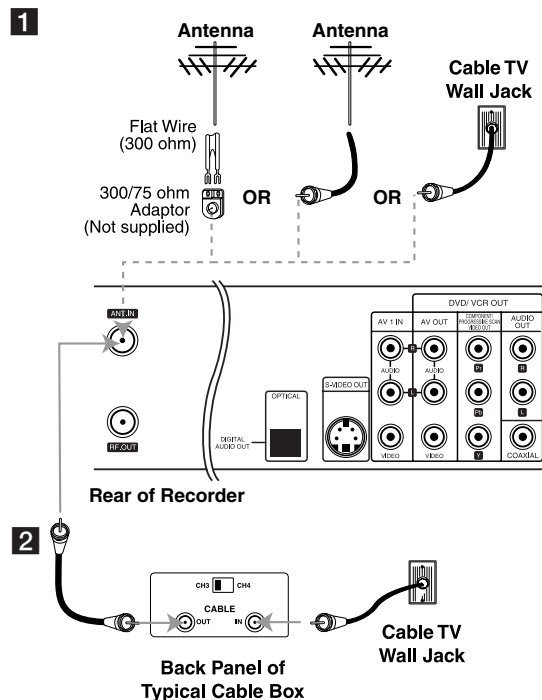

RF coaxial connection

Connect the RF.OUT jack on the Recorder to the antenna in jack on the TV using the supplied 75-ohm Coaxial Cable (R).

How to set the Recorder's RF output channel

1. When the Recorder is turned off, press and hold CH (▼/▲) on the front panel for more than five seconds. [RF-03] or [RF-04] appears in the display window.
2. Press CH (▼/▲) to change the RF output channel (RF-03 or RF-04).
3. Tune the TV to this channel.

Video connection

Connect the DVD/VCR VIDEO OUT jack on the Recorder to the video in jack on the TV using the video cable supplied (V).

Note:

If you use this connection, set the TV's source selector to VIDEO.

S-Video connection

Connect the S-VIDEO OUT jack on the Recorder to the S-Video in jack on the TV using the optional S-Video cable (S).

Component Video / Progressive Scan connection

If your television is a high-definition or "digital ready" television, you may take advantage of the Recorder's progressive scan output for the highest video resolution possible.

Connect the COMPONENT/PROGRESSIVE SCAN VIDEO OUT jacks on the Recorder to the corresponding in jacks on the TV using an optional Y Pb Pr cable (C).

Notes:

- Set Progressive Scan option to [ON] in the setup menu, see page 20.
- Progressive Scan does not work with the RF, Audio/Video or S-Video connections.
- If your TV does not accept the Progressive Scan format, the picture may appear scrambled or no picture at all.
- When you use Component Video signal, set the Progressive Scan to [OFF] on the setup menu.

Audio connection

Connect the Left and Right DVD/VCR AUDIO OUT jacks on the Recorder to the audio left/right in jacks on the TV using the supplied audio cables (A1 or A2).

Connection to an Amplifier

Connecting to an amplifier equipped with two channel analog stereo or Dolby Pro Logic II/Pro Logic

Connect the Left and Right AUDIO OUT (or DVD/VCR AUDIO OUT) jacks on the Recorder to the audio left and right in jacks on your amplifier, receiver, or stereo system using the audio cables (A) supplied.

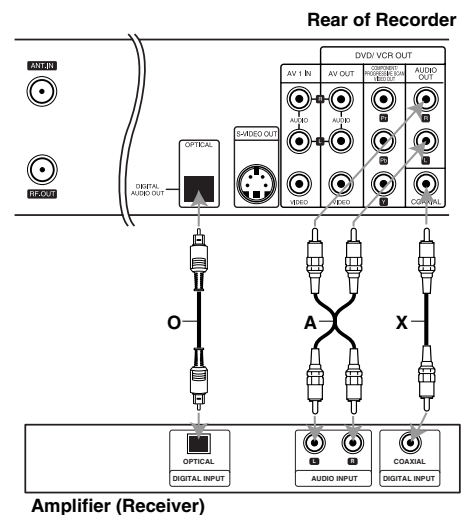

Manufactured under license from Dolby Laboratories. "Dolby", "Pro Logic", and the double-D symbol are trademarks of Dolby Laboratories.

DTS and DTS Digital Out are trademarks of Digital Theater Systems, Inc.

Connecting to an amplifier equipped with two channel digital stereo (PCM) or to an Audio/Video receiver equipped with a multi-channel decoder (Dolby Digital™, MPEG 2, or DTS)

1. Connect one of the Recorder's DIGITAL AUDIO OUT jacks (OPTICAL O, COAXIAL X) to the corresponding in jack on your amplifier. Use an optional digital (OPTICAL O, COAXIAL X) audio cable.
2. You will need to activate the Recorder's digital output. (See [Audio Settings] on page 21).

Digital Multi-channel sound

A digital multi-channel connection provides the best sound quality. For this you need a multi-channel Audio/Video receiver that supports one or more of the audio formats supported by your Recorder (MPEG 2, Dolby Digital and DTS). Check the receiver manual and the logos on the front of the receiver.

Caution:

Due to the DTS Licensing agreement, the digital output will be in DTS digital out when DTS audio stream is selected.

Notes:

- If the audio format of the digital output does not match the capabilities of your receiver, the receiver will produce a strong, distorted sound or no sound at all.
- Six Channel Digital Surround Sound via digital connection can only be obtained if your receiver is equipped with a Digital Multi-channel decoder.
- To see the audio format of the current DVD in the on-screen display, press AUDIO.
- This Recorder does not perform internal (2 channel) decoding of a DTS sound track. To enjoy DTS multi channel surround, you must connect this Recorder to a DTS compatible receiver via one of this Recorder's digital audio outputs.

Accessory Audio/Video (A/V) Connections to Recorder

Connect the AV 1 IN or AV 2 IN jacks on the Recorder to the audio/video out jacks on your accessory component, using the optional audio/video cables. (Refer to page 37 for [Recording from External Components].)

Note:

If you use the S-VIDEO IN jack on the front panel, the VIDEO IN jack on the front panel is not available.

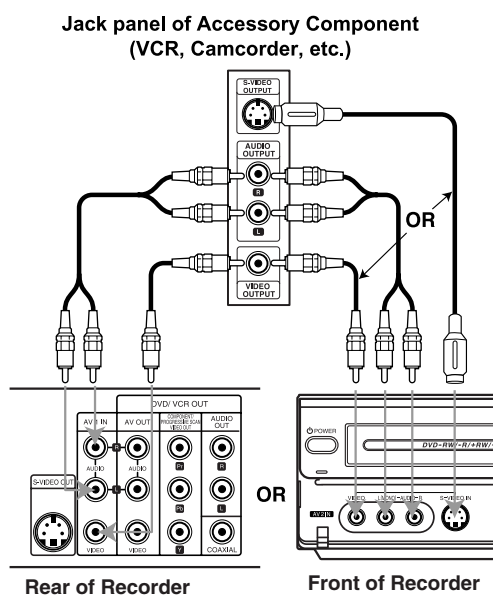

Initial Settings

In this menu system, there are several ways to customize the settings provided. Most menus consist of three levels to set up the options, but some require greater depth for the variety of settings.

General Operation

1. Press SETUP and the Setup menu appears.
2. Use ▲ / ▼ to select the desired option.
3. While the desired item is selected, press ► to move to the second level.
4. Use ▲ / ▼ to select the second desired option.
5. Press ► to move to the third level.
6. Use ▲ / ▼ to select the desired setting then press ENTER to confirm your selection.
Some items require additional steps.
7. Press SETUP to exit the Setup menu.

Note:

Press ◀ to go back to the previous level.

General Settings

Tuning Band Select

1. Select the [Tuning Band] option then press ►.
2. Use ▲ / ▼ to select the tuning band (TV or CATV) option then press ENTER.
TV: If you are using a standard antenna to receive channels.
CATV: If you are using basic cable to receive channels.



Auto Channel Set

Connect the Recorder to the desired type of antenna or cable TV system as shown on page 15.

This Recorder is equipped with a frequency synthesized tuner capable of receiving up to 181 channels. These include VHF channels 2-13, UHF channels 14-69 and CATV channels 1-125.

1. Select the [Tuning Band] option.
2. Use ► / ▲ / ▼ to select [START] icon.
3. Press ENTER to begin the channel search.
The tuner will automatically cycle through all available channels in the area and place them in the tuner's memory.

Note:

After the Auto Channel Set proceeding is complete, make sure the Tuning Band is set appropriately (TV or CATV) on tuning band, follow steps 1~2 as shown previous (Tuning Band Select) to choose the correct Tuning Band (TV or CATV).

To Add or Erase Channels from Memory

This feature allows you to add to or erase channels from memory manually.

1. Select the [CH. Add/Del] option.
2. Press ► to move to the third level.
[Edit] icon is highlighted.
3. Press ENTER and the Channel Edit menu appears.



4. Use ▲ / ▼ or number buttons to select a channel to add or delete then press ►.
[Add] or [Delete] icon is highlighted.
5. Press ENTER to confirm your setting.
6. Repeat steps 4-5 to add or erase additional channels.
7. Press RETURN (↶) to exit the menu.

Clock Set

1. Select the [Clock Set] option.
2. Press ► to move to the third level.

Auto

The Auto option is set at the factory. In the Auto option, the Recorder looks for a channel carrying XDS (Extended Data Services) information. XDS updates the clock using the Coordinated Universal Time.

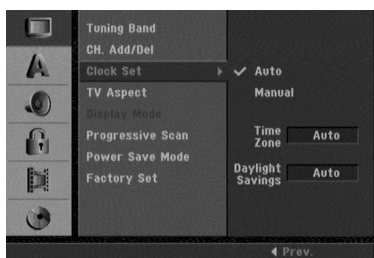

1. Use ▲ / ▼ to choose your Time Zone manually. When Timezone is set to Auto, the Recorder will use XDS information to determine the proper setting.
2. Use ► to choose the [Daylight Savings] option. Use ▲ / ▼ to choose Auto, On, or Off. When it is set to Auto, the Recorder will use XDS information to determine the proper setting.
3. Press ENTER to confirm your setting.

Note :

The Auto Clock Feature enables the Recorder to set up the clock when the Recorder is turned off.

Manual

If your local TV station does not send date and time information, or sends incorrect information, you can set the clock manually.

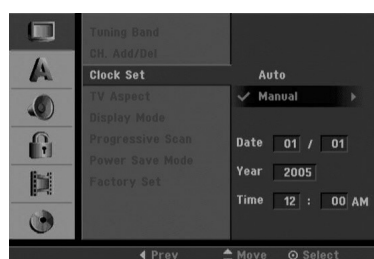

1. Enter the necessary information for year, date and time.
 - ◀ / ▶ (left/right): Moves the cursor to the previous or next column.
 - ▲ / ▼ (up/down): Changes the setting at the current cursor position.
2. Press ENTER to confirm your setting.
3. Press SETUP to exit the Setup menu.

TV Aspect

Selects the aspect ratio of the connected TV (4:3 standard or wide).

- [4:3] Select this when connecting to a 4:3 screen TV. When you select [4:3], set [Display Mode] below.
- [16:9] Select this when connecting to a wide-screen TV or TV with a wide mode function.



Display Mode

Selects how to display a wide picture on the screen when [4:3] is selected in [TV Aspect].

- [Letter Box] Displays a wide picture with bands on the upper and lower portions of the screen.
- [Pan Scan] Automatically displays a wide picture on the entire screen and cuts off the portions that do not fit.

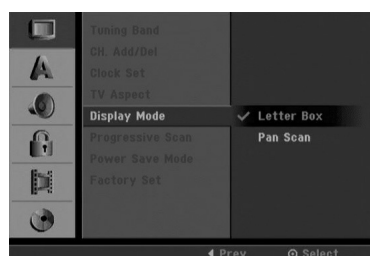

Progressive Scan

Progressive Scan Video provides the highest quality pictures with less flickering.

[ON] : Using the COMPONENT/PROGRESSIVE SCAN VIDEO OUT jacks for connection to a TV or monitor that is compatible with a progressive scan signal.

[OFF] : Using the COMPONENT/PROGRESSIVE SCAN VIDEO OUT jacks, but are connecting the Recorder to a standard (analog) television.

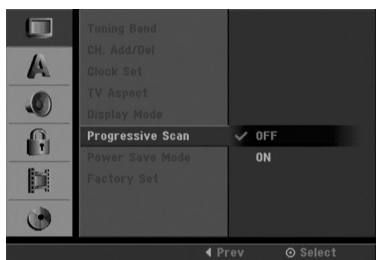

Caution

Once the setting for Progressive Scan output is entered, an image will only be visible on a Progressive Scan compatible TV or monitor. If you set Progressive Scan to [ON] in error, you must reset the Recorder. First, remove any disc or tape in the Recorder. Next, press STOP (■) and hold it for five seconds before releasing it. The video output will be restored to the standard setting, and a picture will once again be visible on a conventional analog TV or monitor.

Power Save Mode

Set [Power Save Mode] to [ON] to place your Recorder into an economic power save mode.

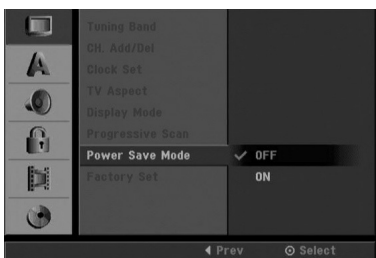

Factory Set

You can reset the Recorder to its original factory settings. Some options cannot be reset (Rating, Set Password and Area Code).

1. Select the [Factory Set] option.
2. Press ► to select [Set] then press ENTER. The Initialize menu will appear.

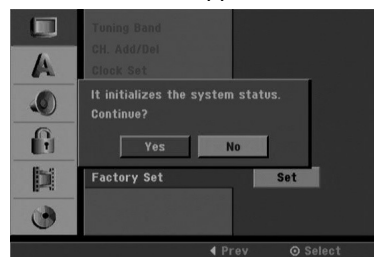

3. Select [Yes] and press ENTER.

Language Settings

Display Menu

Select a language for the Setup menu and information display.



Disc Menu/Audio/Subtitle

[Original] : Refers to the original language in which the disc was recorded.

[Others] : To select another language, press number buttons then ENTER to enter the corresponding 4-digit number according to the language code list in the reference chapter (see page 46).

If you enter the wrong language code, press ◀ .
[OFF] (for Disc Subtitle) : Turn off Subtitle.



Audio Settings

Each DVD disc has a variety of audio output options. Set the Recorder's Audio Output according to the type of audio system you use.

Dolby Digital / DTS / MPEG

[Bitstream]: Select [Bitstream] if you connect the DVD+VCR's DIGITAL AUDIO OUT jack to an amplifier or other equipment with a Dolby Digital, DTS or MPEG decoder.

[PCM] (for Dolby Digital / MPEG): Select when connected to a two-channel digital stereo amplifier. DVDs encoded in Dolby Digital or MPEG will be automatically downmixed to two-channel PCM audio.

[OFF] (for DTS): If you select [OFF], the DTS signal is not output through the DIGITAL AUDIO OUT jack.

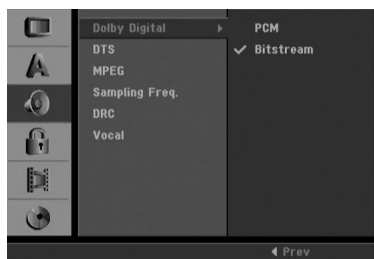

Sampling Freq. (Frequency)

If your receiver or amplifier is NOT capable of handling 96 kHz signals, select 48 kHz. When this choice is made, this unit automatically converts any 96 kHz signals to 48 kHz so your system can decode them. If your receiver or amplifier is capable of handling 96 kHz signals, select 96 kHz. When this choice is made, this unit passes each type of signal through without any further processing.

Check the documentation for your amplifier to verify its capabilities.

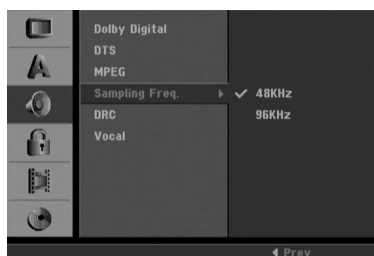

DRC (Dynamic Range Control)

With the DVD format, you can hear a program's soundtrack in the most accurate and realistic presentation possible, thanks to digital audio technology. However, you may wish to compress the dynamic range of the audio output (the difference between the loudest sounds and the quietest ones). This allows you to listen to a movie at a lower volume without losing clarity of sound. Set DRC to [ON] for this effect.

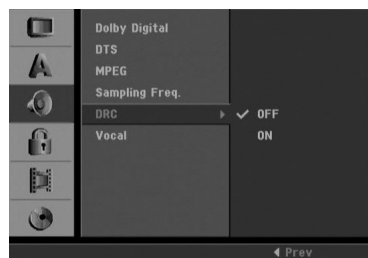

Vocal

Set Vocal to [ON] only when a multi-channel karaoke DVD is playing. The karaoke channels on the disc will mix into normal stereo sound.

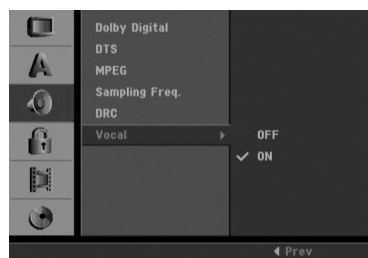

Lock (Parental Control) Settings

Rating

Some movies contain scenes that may not be suitable for children to view. Many of these discs contain parental control information that applies to the complete disc or to certain scenes on the disc. Movies and scenes are rated from 1 to 8, depending on the area (country). DVD video discs may or may not respond to the parental control setting if the Area code (Country code) of the disc is set wrongly. Some discs offer more suitable scenes as an alternative. Ratings are area (country) dependent. The parental control feature allows you to block access to scenes below the rating you input, thereby preventing your children from being able to view material you believe is unsuitable.

1. Select [Rating] option then press ►.
2. To access the Rating, Password and Area Code (Country Code) features, you must input the 4-digit security code you created.

If you have not yet entered a security code you are prompted to do so. Input a 4-digit code and press ENTER. Enter it again and press ENTER to verify. If you make a mistake before pressing ENTER, press ◀.

3. Select a rating from 1 to 8 using the ▲ / ▼ buttons.

[1]-[8] : Rating one (1) has the most restrictions and rating eight (8) is the least restrictive.

[No Limit] : If you select [No Limit], parental control is not active and the disc plays in full.

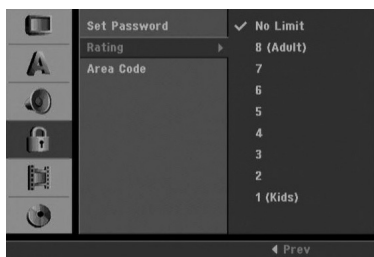

4. Press ENTER to confirm your rating selection, then press SETUP to exit the menu.
5. Press OPEN/CLOSE (▲) to activate parental control.

Note:

If you set a rating for the recorder, all disc scenes with the same rating or lower are played. Higher rated scenes are not played unless an alternate scene is available on the disc. The alternative must have the same rating or a lower one. If no suitable alternative is found, playback stops. You must enter the 4-digit password or change the rating level in order to play the disc.

Set Password

You can enter or change password.

1. Select [Set Password] option then press ►.



2. Follow step 2 as shown [Rating]. To change the password, select the [Change], press ENTER and input the new 4-digit code then press ENTER. Input it again to verify.
3. Press SETUP to exit the menu.

If you forget your password

If you forget your password you can clear it using the following steps:

1. Press SETUP to display the Setup menu.
2. Input the 6-digit number [210499]. The message appears, select [Yes] then press ENTER. The security code is cleared.
3. Enter a new code as described above.

Area Code (Country Code)

Enter the Area Code (Country Code) whose standards were used to rate the DVD video disc, based on the list in the reference chapter (see page 46).



1. Select [Area Code] option then press ►.
2. Follow step 2 as shown [Rating].
3. Select the first character using ▲ / ▼ buttons.
4. Shift the cursor using ► buttons and select the second character using ▲ / ▼ buttons.
5. Press ENTER to confirm your area code selection, then press SETUP to exit the menu.

Recording Settings

Disc Record Mode

You can set the picture quality for recording; XP (Excellent quality), SP (Standard quality), LP (Low quality), EP (Extend quality).

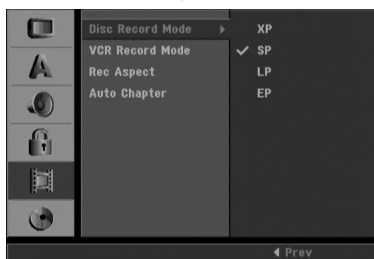

1. Select the [Disc Record Mode] option then press ►.
2. Use ▲ / ▼ to select a desired Disc Record Mode (XP, SP, LP or EP).
3. Press ENTER to confirm your selection, then press SETUP to exit the menu.

VCR Record Mode

You can set the picture quality for VCR recording; SP (Standard Play), SLP (Super Long Play).



Record Aspect

When DVD recording, you can set the recording aspect ratio to suit the material you're recording (16:9 or 4:3).



Auto Chapter

During recording, chapter markers are added automatically at fixed intervals. You can set this interval to 5 minutes, 10 minutes or 15 minutes. To turn off automatic chapter marking, select [None].

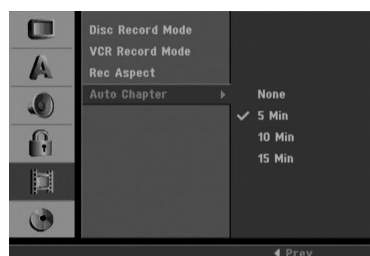

Disc Settings

Initialize

If you load a completely blank disc, the [Initialize] menu will appear. Select [Yes] then press ENTER. The Recorder will initialize the disc.

DVD-R: The Recorder initializes the disc for Video mode. The recording mode will always be Video mode.

DVD-RW: The Initialize menu will appear. Select [VR Mode] or [Video Mode] then press ENTER.

DVD+R / DVD+RW: The Recorder initializes the disc.

Also, you can reformat the DVD-RW/DVD+RW from the Setup menu as below.



1. Select the [Initialize] option then press ►. [Start] icon is highlighted.
2. Press ENTER.
 - In case of DVD-RW, use ◀ / ▶ to select a desired Disc Initialize Mode (VR Mode or Video Mode) then press ENTER.
 - In case of DVD+RW, use ◀ / ▶ to select [Yes], and press ENTER. It takes a few moments to format the disc.

Caution:

If you want to change the disc format, everything recorded on the disc will be erased.

Finalize

Finalizing 'fixes' the recordings in place so that the disc can be played on a regular DVD player or computer equipped with a suitable DVD-ROM drive. Finalizing a Video mode disc creates a menu screen for navigating the disc. This is accessed by pressing DISC MENU/LIST or TITLE.

⚠ Caution

Once you have finalized a DVD-R and DVD+R disc, you cannot edit or record anything else on that disc except DVD+RW. However, you can record and edit a DVD-RW disc by choosing [Unfinalize] option.

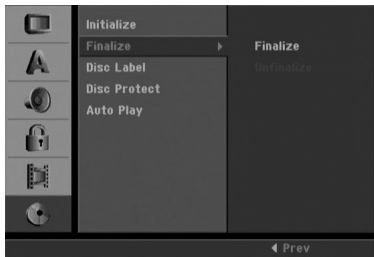

1. Select the [Finalize] option then press ►.
2. Press ENTER while [Finalize] is selected. Finalize menu appears.
3. Select [Yes] then press ENTER. The Recorder starts finalizing the disc.

Note:

Finalization can take up to 3-4 minutes or more depending on the type of disc, how much is recorded on the disc, and the number of titles on the disc.

Tips:

- If you load a DVD-RW that has already been finalized, you can 'Unfinalize' it by choosing [Unfinalize] from the Finalize menu. After doing this, you can edit and re-record onto the disc.
- You cannot unfinalize a DVD-R and DVD+R disc.
- If [Disc Protect] option is set to [ON], the finalize is not available. To finalize, set [Disc Protect] option to [OFF].

Disc Label

Use the Disc Label feature to enter a name for the disc. This name appears when you load the disc and when you display disc information on-screen.

- The Disc label can be up to 32 characters long.
- For discs formatted on a different Recorder, you will see only a limited character set.



1. Select the [Disc Label] option then press ►. [Edit] icon is highlighted.
2. Press ENTER. Keyboard menu appears. To enter characters, see page 42.

Disc Protect

Depending on the type of disc you are using, Disc Protect allows you to preserve your recordings in a variety of ways:

- DVD+RW : Prevents editing, regular recording, erasing, or overwriting of existing recordings.
- DVD+R/DVD-RW(VR mode) : Prevents editing, erasing, and regular recording.

Notes:

- Disc Protect is not compatible with DVD-RW discs in Video mode or DVD-R discs.
- If you need to unlock a disc to make edits, select [OFF].



AutoPlay

When you load a DVD with AutoPlay turned on, the Recorder will bypass the Disc menu and trailers and start playing the movie automatically. Set [AutoPlay] to [ON] or [OFF].



General Explanation of On-Screen Display

Some DVDs require specific operation or allow only limited operation during playback. When this occurs,

⊘ is displayed, action prohibited or not available.

Displaying Information While Watching TV

While watching TV, press DISPLAY to display/remove the information displayed on-screen.

e.g., when DVD-RW in VR mode is inserted.

Indicates current media and title.

Indicates the record mode, free space, and elapsed time progress bar.

Indicates channel number and audio input signal received by the tuner.



Indicates current date and time.

Indicates operational mode of the recorder.

Changing TV Audio Channel

Some TV programs are broadcast with both a main and a Secondary Audio Program (SAP). You can change the TV audio.

Press AUDIO repeatedly to change the TV audio, according to Broadcast audio signal as shown below.

- STEREO+SAP Audio Signal
Stereo → SAP → Mono → Stereo
- STEREO Audio Signal
Stereo → L → R → Mono → Stereo
- SAP Audio Signal
Mono → SAP → Mono
- MONO Audio Signal
Mono

The current audio channel is displayed on-screen.

- If SAP is selected, but there is no SAP channel being broadcast, you will still hear the main audio (Mono or Stereo) channel.
- If the sound is poor quality when set to Stereo, you can often improve it by changing to Mono.
- When an external input is selected, the audio channel can be switched only to Stereo.

Displaying Disc Information on-screen

You can display various information about the disc or tape loaded on-screen. Some items can be changed using the menu.

1. Press DISPLAY to show various playback information.

The items displayed differ depending on the disc type or playing status.

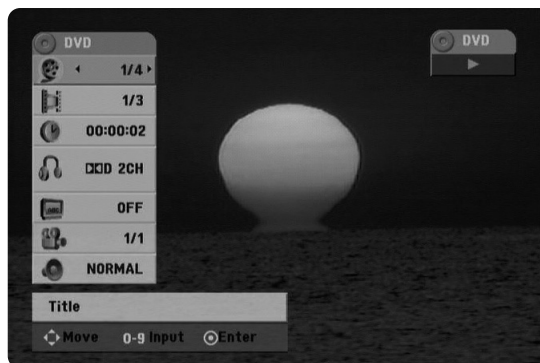

2. You can select an item by pressing ▲ / ▼ and change or select the setting by pressing ◀ / ▶. For details about each item, see the pages in parentheses.

- [Title]: Current title (or track) number/total number of titles (or tracks) (page 27)
- [Chapter]: Current chapter number/total number of chapters (page 27)
- [Time]: Elapsed playing time (page 28)
- [Audio]: Selected audio language (DVD VIDEO only) or audio channel (page 29)
- [Subtitle]: Selected subtitle (page 29)
- [Angle]: Selected angle/total number of angles (page 29)
- [Sound]: Selected sound mode (page 29)

Note:





If no button is pressed for 10 seconds, the on-screen display disappears.

Playback

VCR Tape Playback

Press **VCR** button to select the device to be operated.

Basic Instructions

1. Insert a pre-recorded video cassette.
The  indicator lights and the Recorder powers on automatically.
2. If a tape without a safety tab is inserted the unit starts playback automatically.
If not, press **PLAY** (.
3. Press **STOP** () to stop playback. **STOP** appears on the TV screen. If the tape reaches the end before you press **STOP** () the Recorder automatically stops, rewinds and ejects the tape.

Note:



It is not necessary to select the tape speed for playback because it is automatically selected by the Recorder. Also, during playback the TV/VCR selector switches to VCR mode automatically.

Auto Tracking

Automatic tracking adjusts the picture to remove snow or streaks and beings when:

- A tape is played for the first time.
- The tape speed (SP, LP, SLP) changes.
- Streaks or snow appear due to scratches on the tape.

Manual Tracking

To manually adjust the tracking use the **CH/TRK** () buttons on the remote control or **CH** () on the front panel during playback.



Notes:

- Vertical jitter requires a very fine adjustment.
- Tracking is automatically reset to normal when the tape is ejected or the power cord is unplugged for more than 3 seconds.

Search

This function lets you visually search for a tape section in either direction: forward and reverse. During the high-speed picture search modes, the audio is muted and horizontal lines (noise bars) appear. Also, a short time is needed to stabilize the tape speed when re-entering the **PLAY** mode so slight interference may be observed during this time.





To search:

1. Press **BACKWARD** () or **FORWARD** () during playback.
2. To return to playback, press **PLAY** (.

Note:

After 3 minutes in **SEARCH** mode the Recorder returns to **PLAY** mode to protect the tape and video heads.

Still Picture and Frame-by-Frame Playback



1. Press **PAUSE/STEP** () during playback.
A still picture appears on the TV screen and the audio is muted.
2. If the still picture vibrates vertically, stabilize it by using **CH/TRK** () on the Remote Control.
3. Press **PAUSE/STEP** () repeatedly to advance the video picture one frame at a time.
4. To return to playback, press **PLAY** (.

Note:

After 5 minutes in **STILL** mode the Recorder stops to protect the tape and video heads.

Slow Motion

During slow motion, audio is muted and horizontal lines (noise bars) may appear on the TV screen. This is normal.

1. While in still mode, press **FORWARD** (). The tape is played at a speed 1/19 times slower than the normal speed.
2. Use **CH/TRK** () on the Remote Control if necessary to adjust the tracking.
3. To return to the normal speed, press **PLAY** (.

Note:

After 3 minutes in **SLOW MOTION** mode the Recorder goes back to **PLAY** mode to protect the tape and video heads.

Counter Memory Function

This feature is useful if there is a section of tape you want to view immediately after recording or if you want to return to the same point several times.

1. Begin recording or playing a tape.
2. Press DISPLAY until the real-time counter is displayed on the TV screen.
3. At the point that you want to locate later, reset the real-time counter to [0:00:00] by pressing CLEAR.
4. Continue to play or record.
5. Press STOP (■) when recording or playback finishes.
6. Press RETURN (↶). The tape automatically stops when the tape counter returns to about [0:00:00].

S-VHS Quasi Playback (SQPB)

- This Recorder can play back S-VHS recorded tapes, however, it cannot make recordings using S-VHS format tapes.
- SQPB is an abbreviation for S-VHS Quasi Playback.

Playing a DVD

Playback Setup

1. Press OPEN/CLOSE (⏏) to open the disc tray. Load your chosen disc in the tray, with the playback side down.
2. Press OPEN/CLOSE (⏏) to close the tray. Playback starts automatically. If playback does not start, press PLAY (▶).
In some cases, the disc menu might appear instead.
DVD
Use the ◀ ▶ ▲ ▼ buttons to select the title/chapter you want to view, then press ENTER to start. Press TITLE or DISC MENU/LIST to return to the menu screen.
3. To stop the playback, press STOP (■). The unit records the stopped point, depending on the disc. "IIII" appears on the screen briefly. Press PLAY (▶) to resume playback (from the scene point). If you press STOP (■) again or unload the disc ("■" appears on the screen.), the unit will clear the stopped point. Press OPEN/CLOSE (⏏) to remove the disc. Press OPEN/CLOSE (⏏) to close disc tray or press POWER (⏻), the disc tray closes automatically and unit turns off.

Notes:

- If parental control is set and the disc is not within the rating settings you must input the password. (See [Rating] on page 22).
- DVDs may have a region code. Your Recorder will not play discs that have a region code different from your Recorder. The region code for this player is 1 (one).
- Unless stated otherwise, all operations described use the Remote Control. Some features may also be available on the Setup menu.

Moving to another TITLE

-RW_{VR} -RW_{Video} +RW -R +R DVD

When a disc has more than one title, you can move to another title:

Press DISPLAY then use ▲ / ▼ to select the title icon. Then, press the appropriate numbered button (0-9) or ◀ / ▶ to select a title number.

Moving to another CHAPTER

-RW_{VR} -RW_{Video} +RW -R +R DVD

When a title on a disc has more than one chapter, you can move to another chapter as follows:

- Press SKIP (▶▶) or (◀◀) briefly during playback to select the next chapter or to return to the beginning of the current chapter.
- Press SKIP (◀◀) twice in quick successions to step back to the previous chapter.
- To go directly to any chapter during playback, press DISPLAY and use ▲ / ▼ to select the chapter icon. Input the chapter number or use ◀ / ▶.

Slow Motion

-RW_{VR} -RW_{Video} +RW -R +R DVD

1. Press BACKWARD (◀◀) or FORWARD (▶▶) during pause mode.
2. Use the BACKWARD (◀◀) or FORWARD (▶▶) to select the required speed: 4 steps (forward and backward)
3. To exit Slow Motion mode, press PLAY (▶).

Search

-RW_{VR} -RW_{Video} +RW -R +R DVD

1. Press BACKWARD (◀◀) or FORWARD (▶▶) during playback.
2. Press BACKWARD (◀◀) or FORWARD (▶▶) to select the required speed: 4 steps (forward and backward)
3. To exit SEARCH mode, press PLAY (▶).

Time Search **-RW_{VR}** **-RW_{Video}** **+RW** **-R** **+R** **DVD**

To start playing at any chosen time on the disc:

1. Press DISPLAY during playback. The time search box shows the elapsed playing time.
2. Press ▲ / ▼ to select the time clock icon and [--:--:--] appears.
3. Input the required start time in hours, minutes, and seconds from left to right. If you enter the wrong numbers, press CLEAR. Then enter the correct numbers.
4. Press ENTER to confirm. Playback starts from the selected time.

Marker Search **-RW_{VR}** **-RW_{Video}** **+RW** **-R** **+R** **DVD**

To enter a Marker

You can start playback from up to 9 memorized points. To enter a marker, press MARKER at the desired point on the disc. The Marker icon appears on the TV screen briefly. Repeat to enter up to nine markers.

To Recall or Clear a Marked Scene

1. During disc playback, press SEARCH. The marker search menu appears on the screen.
2. Within 10 seconds, press ◀ / ▶ to select a marker number that you want to recall or clear.
3. Press ENTER and playback starts from the marked scene. Or, Press CLEAR and the marker number is erased from the list.
4. You can play any marker by inputting its number on the marker search menu.

Play mode select

-RW_{VR} **-RW_{video}** **+RW** **-R** **+R** **DVD**
karaoke DVD

Press PLAY MODE to select a desired play mode while playback.

- [Chapter] repeats the current chapter.
- [Title] repeats the current title.
- [Off] does not play repeatedly.

Still Picture and Frame-by-Frame Playback

-RW_{VR} **-RW_{Video}** **+RW** **-R** **+R** **DVD**

1. Press PAUSE/STEP (⏸) during playback. Advance the picture frame-by-frame by pressing PAUSE/STEP (⏸) repeatedly.
2. To exit still motion mode, press PLAY (▶).

Zoom

-RW_{VR} **-RW_{Video}** **+RW** **-R** **+R** **DVD**

Use zoom to enlarge the video image.

1. Press ZOOM during playback or still playback to activate the Zoom function.
2. Each press of the ZOOM button changes the TV screen in the sequence: X1 (normal size) → X2 size → X4 size → X1 (normal size)
3. Use the ◀ ▶ ▲ ▼ buttons to move through the zoomed picture.
4. To resume normal playback, press ZOOM repeatedly or CLEAR button.

Note:

The Zoom function may not work on some DVDs.

Repeat A-B**-RW_{VR} -RW_{Video} +RW -R +R DVD**

To repeat a sequence during playback.

1. Press A-B at your chosen starting point.
[A -] appears briefly on the TV screen.
2. Press A-B again at your chosen end point.
[A - B] appears briefly on the TV screen and the repeat sequence begins.
3. Press A-B again to cancel.

Title Menu DVD

1. Press TITLE. If the current title has a menu, the menu appears on the screen. Otherwise, the disc menu may not appear.
2. The menu offers features such as camera angles, spoken language and subtitle options, and chapters for the title.

Disc Menu DVD

1. Press DISC MENU/LIST and the disc menu is displayed.
2. Press DISC MENU/LIST again to exit.

Camera Angle DVD

If the disc contains scenes recorded at different camera angles, you can change to a different camera angle during playback. Press DISPLAY then select the Angle icon during playback. Use ◀ / ▶ to select a desired angle. Note that the number of the current angle appears on the display.

Tip:

The Camera Angle icon is displayed on the TV screen when alternate angles are available.

Subtitles DVD

1. Press DISPLAY then select the Subtitle icon during playback.
2. Use ◀ / ▶ to display desired subtitle language.

Changing the Audio Soundtrack DVD

Press AUDIO then press ◀ / ▶ repeatedly during playback to hear a different audio language or audio soundtrack if available.

Note:

Some discs feature both Dolby Digital and DTS soundtracks. There is no analog audio output when DTS is selected. To listen to the DTS soundtrack, connect this recorder to a DTS decoder via one of the digital outputs. See page 16 for connection details.

Changing the Audio Channel**-RW_{VR} -RW_{Video} +RW -R +R DVD**

Press AUDIO then press ◀ / ▶ repeatedly during playback to hear a different audio channel.

With DVD-RW discs recorded in VR mode that have both a main and a Bilingual audio channel, you can switch between Main (L), Bilingual (R), or a mix of both (Main + Bilingual) by pressing AUDIO.

3D Surround**-RW_{VR} -RW_{Video} +RW -R +R DVD**

This unit can produce a 3D Surround effect, which simulates multi-channel audio playback from two conventional stereo speakers, instead of the five or more speakers normally required to listen to multi-channel audio from a home theater system.

1. Press DISPLAY then use ▲ / ▼ to select the sound icon. Then, use ◀ / ▶ to select [3D SUR].
2. To turn off the 3D Surround effect, select [NORMAL].

Last Scene Memory DVD

This Recorder memorizes last scene from the last disc that is viewed. The last scene remains in memory even if you remove the disc from the Recorder or switch off the Recorder. If you load a disc that has the scene memorized, the scene is automatically recalled.

Notes:

- Settings are stored in memory for use any time.
- This Recorder does not memorize settings of a disc if you switch off the Recorder before commencing to play it.
- The Last Scene Memory function may not work on some DVDs.
- Last Scene Memory function for a previous DVD title is erased once a different DVD title is played.

Playing an Audio CD or MP3/WMA files

The Recorder can play Audio CDs and MP3/WMA files on CD-ROM, CD-R/RW, DVD+R/RW or DVD-R/RW discs.

Before playing MP3/WMA files, read [Notes on MP3/WMA Recordings] on page 31.

Audio CD

Once you insert an audio CD a menu appears on the TV screen. Use ▲ / ▼ to select a track then press PLAY (▶) and playback starts.

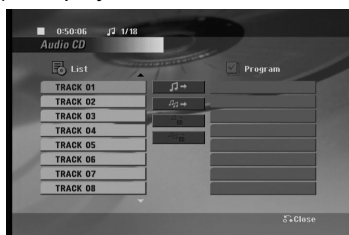

MP3 / WMA

1. Use ▲ / ▼ to select a folder, and press ENTER. A list of files in the folder appears.
2. Use ▲ / ▼ to select a track then press PLAY (▶) and Playback starts.

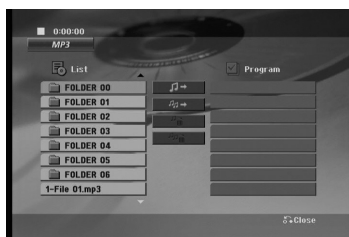

Tips:

- You can view TV channel or video input source by pressing RETURN (↵). If you want to return to the Music menu, press DISC MENU/LIST.
- Press DISPLAY to view ID3-Tag information for the MP3 file. Press DISPLAY again to remove the information screen.
- Press and hold ▲ / ▼ for fast to move to the next/previous track or folder.
- On CDs or DVDs with mixed content (MP3/WMA files or JPEG files), you can select between the MP3/WMA menu and JPEG menu. Press TITLE a word on top on the menu is highlighted. Then, use ◀ / ▶ to select MP3/WMA or JPEG then press ENTER.
- If you are in a file list and want to return to the Folder list, use the ▲/▼ to highlight [Folder icon] and press ENTER to return to the previous menu screen.

Audio CD and MP3/WMA file Features

Pause

1. Press PAUSE/STEP (⏸) during playback.
2. To return to playback, press PLAY (▶) or press PAUSE/STEP (⏸) again.

Moving to another Track

- Press SKIP (▶▶ or ◀◀) briefly during playback to go to the next track or to return to the beginning of the current track.
- Press SKIP (◀◀) twice in quick successions to go back to the previous track.
- On an Audio CD, to go directly to any track, enter the track number using the numbered buttons (0-9) during playback.

Play mode select

Press PLAY MODE to select a desired play mode.

- [TRACK]: Repeats the current track.
- [ALL] (CD): Repeats all the tracks on a disc.
- [Random]: Random playback.
- [OFF](No display): Does not play repeatedly.

Tip:

By pressing SKIP (◀◀ or ▶▶) during random playback, the unit selects another track and resumes random playback.

Repeat A-B **ACD**



1. To repeat a sequence during disc playback. Press A-B at your chosen starting point. The Repeat icon and [A] appear on the menu screen.
2. Press A-B again at your chosen end point. The Repeat icon and [A-B] appear on the menu screen, and the sequence begins to play repeatedly.
3. Press A-B again to cancel.

Search **ACD**

1. Press BACKWARD (◀◀) or FORWARD (▶▶) during playback.
2. Press BACKWARD (◀◀) or FORWARD (▶▶) to select the required speed (3 steps).
3. To exit SEARCH mode, press PLAY (▶).

Program Playback with Audio CD and MP3 / WMA files

The program function enables you to store your favourite tracks from any disc in the player memory. Program can contain 99 tracks (Audio CD) or 256 tracks (MP3/WMA).

1. Insert a disc.
Audio CD and MP3/WMA Discs:
Audio CD or MP3/WMA menu appears.
2. Select a track on the List.
3. Select “” icon then press ENTER to place the selected track on the Program list. Repeat to place additional tracks on the list.
You can add all tracks in the disc. Select “” icon then press ENTER.
4. Select the track you want to start playing on the Program list.

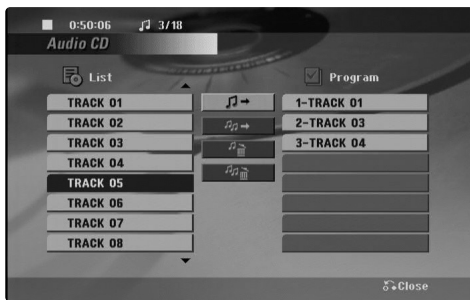

Example) Audio CD





5. Press PLAY () or ENTER to start. Playback begins in the order in which you programmed the tracks. Playback stops after playing the last programmed track on the program list.

Play mode selection for Programmed Tracks

Press PLAY MODE to select the desired play mode.

- [TRACK] Repeats the current track.
- [ALL] Repeats all tracks on the Program List.
- [OFF] Cancels Repeat mode (no display).
- [Random] Random playback on the Program List.

Erasing a Track from Program List

1. Use     to select the track that you wish to erase from the Program list.
2. Press CLEAR. Or, select “” icon then press ENTER to erase the selected track on the Program list. Repeat to erase additional tracks on the list.

Erasing the Complete Program List

Select “”, then press ENTER. The complete Program for the disc is erased.

Note:

The programs are also cleared when the disc is removed.

Notes on MP3/WMA Recordings

MP3 / WMA disc compatibility with this unit is limited as follows:

- Sampling frequency: within 32 - 48 kHz (MP3), within 32 - 48 kHz (WMA)
- Bit rate: within 32 - 320 kbps (MP3), 32 - 192 kbps (WMA)
- This unit cannot read an MP3/WMA file that has a file extension other than “.mp3” / “.wma”.
- CD-R physical format should be “ISO 9660” and “JOLIET”.
- DVD±R/RW physical format should be “ISO 9660 (UDF Bridge format)”.
- If you record MP3 / WMA files using software that cannot create a file system (eg. Direct-CD) it is impossible to playback MP3 / WMA files. We recommend that you use Easy-CD Creator, which creates an ISO 9660 file system.
- The total number of files and folders on the disc should be less than 999.

This unit requires discs and recordings to meet certain technical standards in order to achieve optimal playback quality. Pre-recorded DVDs are automatically set to these standards. There are many different types of recordable disc formats (including CD-R containing MP3 or WMA files) and these require certain pre-existing conditions (see above) to ensure compatible playback.

Customers should note that permission is required in order to download MP3 / WMA files and music from the Internet. Our company has no right to grant such permission. Permission should always be sought from the copyright owner.

Viewing a JPEG File

This unit can play JPEG files on CD-R/RW, DVD+R/RW, DVD-R/RW discs. Before playing JPEG recordings, read [About JPEG image files].

1. Insert a disc and close the tray. The JPEG menu appears on the TV screen.

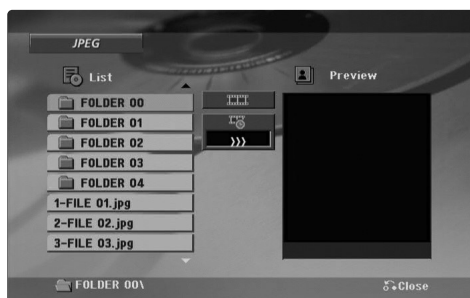

2. Press ▲ / ▼ to select a folder, then press ENTER. A list of files in the folder appears.
3. If you want to view a particular file, press ▲ / ▼ to highlight a file then press ENTER or PLAY (▶). The selected image is displayed in full screen.

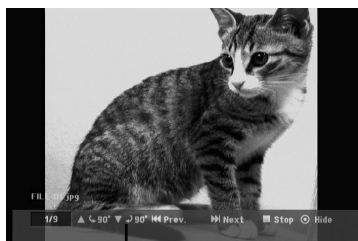

Press ENTER to display or remove this menu.

4. To stop viewing at any time, press STOP (■). The menu screen appears.

Tip:

- If you are in a file list and want to return to the Folder list, use the ▲/▼ to highlight [Folder] and press ENTER to return to the previous menu screen.
- Press and hold ▲/▼ to go to the next/previous page.
- On CDs or DVDs with mixed content (MP3/WMA files or JPEG files), you can select between the MP3/WMA menu and JPEG menu. Press TITLE a word on top on the menu is highlighted. Then, use ◀ / ▶ to select MP3/WMA or JPEG then press ENTER.
- You can view TV channel or video input source by pressing RETURN (↵). If you want to return to the Music menu, press DISC MENU/LIST.

Still picture

Use PAUSE/STEP (⏸) while showing a picture to pause mode.

Skip Images

While viewing a picture, press SKIP (▶▶ or ◀◀) once to advance to the next file or return to the previous file.

Rotate Images

Use ▲ / ▼ while viewing a picture to flip the picture clockwise or counterclockwise.

Slide Show JPEG

Use ▲ ▼ ◀ ▶ to highlight the [Slide Show] on the JPEG menu then press ENTER.

Slide Show starts from the selected file if Speed option is not [II] (Off). While viewing a file, you can press STOP (■) to move to the previous menu (JPEG menu).

- There are four Slide Speed options ([Speed]): >>> (Fast), >> (Normal), > (Slow) and II (Off). Use ▲ ▼ ◀ ▶ to highlight the Speed options ([Speed]). Then, use ◀ / ▶ to select the option you want to use then press ENTER.

To listen to music while slide show simultaneously JPEG

You can display photo files while listening to MP3/WMA music files recorded on a disc. Select [Music] icon then press ENTER on the JPEG menu.

About JPEG image files

JPEG disc compatibility with this recorder is limited as follows:

- Depending upon the size and number of JPEG files, it could take a long time for the recorder to read the files. If you don't see an on-screen display after several minutes, some of the files may be too large — reduce the resolution of the JPEG files to less than 4M pixels.
- The total number of files and folders on the disc should be less than 999.
- Some discs may be incompatible due to a different recording format or the condition of disc.
- Ensure that all the selected files have the “.jpg” extensions when copying into the CD layout.
- If the files have “.jpe” or “.jpeg” extensions, please rename them as “.jpg” file.
- File names without “.jpg” extension will not be able to be read by this recorder. Even though the files are shown as JPEG image files in Windows Explorer.

Recording

About DVD recording

Notes:

- This Recorder cannot record CD-R or CD-RW discs.
- Fingerprints and small scratches on a disc can affect playback and/or recording performance. Please take proper care of your discs.
- The company does not hold any responsibility to compensate the contents which should have been recorded, and any losses or damages (e.g. losses of business profit, or business intermission) that may arise from malfunction of this recorder (not recording/editing as intended).

Disc types and recording formats, modes, and settings

This recorder can play many different kinds of DVD discs: pre-recorded DVD-Video discs, DVD-RW, DVD-R, DVD+RW and DVD+R discs. The disc format for DVD-R, DVD+R, DVD+RW discs is always "Video format"—the same as pre-recorded DVD-Video discs. This means that once finalized, you can play a DVD-R, DVD+R, or DVD+RW in a regular DVD player. The DVD-RW disc format is Video Recording (VR) format or Video format. You can change Recording format, if required. (Reinitializing the disc will erase the contents of the disc.)

The recording mode is closely related to the disc format. If the disc format is Video Recording format, then the recording mode is VR mode; if the disc format is Video mode, then the recording mode is Video mode (except for DVD-Video, which is not recordable, and so does not have a recording mode). These can be changed as required for each recording and determine the picture quality and how much space the recording will take up on the disc.

Notes for recording

- The recording times shown are not exact because the recorder uses variable bit-rate video compression. This means that the exact recording time will depend on the material being recorded.
- When recording a TV broadcast, if the reception is poor or the picture contains interference, the recording times may be shorter.
- If you record still pictures or audio only, the recording time may be longer.
- The displayed times for recording and time remaining may not always add up to exactly the length of the disc.
- The recording time available may decrease if you heavily edit a disc.
- If using a DVD-RW disc, make sure you change the recording format (Video mode or VR mode) before you record anything on the disc. See page 23 (Initialize) for how to do this.
- When using a DVD-R or DVD+R disc, you can keep recording until the disc is full, or until you finalize the disc. Before you start a recording session, check the amount of recording time left on the disc.
- When using a DVD-RW disc in Video mode, recording time available will only increase if you erase the last title recorded on the disc.
- The Delete Title option in the Title List (Original) menu only hides the title, it does not actually erase the title from the disc and increase the recording time available (except for the last recorded title on a DVD-RW disc in Video mode).
- Overwrite recording is available using DVD+RW discs.
- When using a DVD+R/RW, the recorder will execute the Menu-making operation to update the new title and editing when removing the disc from the recorder.

Basic Recording from a TV

Follow the instructions below to record a TV program. Recording starts immediately and continues until the disc or tape is full or you stop the recording.

1. Switch on the Recorder, select the device (VCR or DVD) for Recording and load a recordable disc or tape. Also make sure that the TV input is set to this recorder.
2. Set a recording mode as necessary by pressing REC MODE repeatedly.
DVD: XP, SP, LP, EP.
VCR: SP, SLP.
3. Select the TV channel to record.
4. Use AUDIO to select the audio channel to record. The table below shows what will be recorded on the different settings for different types of broadcast. The last column (Monitor Audio) shows what you'll hear as it is recording.

TV Broadcast	Selected Audio	Broadcast Audio		Monitor Audio
		L Ch	R Ch	
MONO	MONO	MONO	MONO	MONO
STEREO	STEREO	L	R	STEREO
	Left	L	L	Left
	Right	R	R	Right
MONO+SAP	MONO	MONO	MONO	MONO
	SAP	SAP	SAP	SAP
STEREO +SAP	STEREO	L	R	STEREO
	SAP	SAP	SAP	SAP
	MONO	MONO	MONO	MONO

If you set the audio channel to SAP, but there is no SAP channel being broadcast, the main audio (mono or stereo) will be recorded.

5. Press ● REC once to start recording. The REC indicator lights in the display window.
6. Press STOP (■) to stop recording.

Notes:

- The maximum numbers of DVD titles are as show below;
- DVD-R/RW : 99
- DVD+R/RW : 49
- If the Recorder is powered off during DVD recording, the recording will not be saved.

Instant Timer Recording

Instant Timer Recording allows you to make a recording easily of a preset length without using the program timer.

1. Follow steps 1-4 as shown left (Basic Recording from a TV).
2. Press ● REC repeatedly to select the recording time length. Recording starts after the first press.
DVD: Each subsequent press increases the recording time by 10 minutes.

VCR: Each subsequent press increases the recording time by 30 minutes (maximum 540 minutes). Please confirm the VHS tape has enough remaining time to be recorded before recording.



Instant Timer Record Menu

Checking the Recording Time

Press ● REC or DISPLAY once to check the recording time. The recalled setting will automatically return to the TV screen for a moment.

Also, remaining time of recording is shown in the display window.

To Extend the Recording Time

The recording time can be extended anytime by pressing ● REC.

Each subsequent press increases the recording time by 10 minutes (DVD) or 30 minutes (VCR).

To Pause the Recording

1. Press PAUSE/STEP (||) to pause the recording.
2. When you want to continue recording, press PAUSE/STEP (||) or ● REC.

Notes:

- If you press PAUSE/STEP (||) during the Instant Timer Recording, it will be canceled.
- The Recorder will automatically power off when the Instant Timer Recording ends.
- If the unit is DVD mode when the VCR Instant timer recording ends, the unit will not automatically power off.
- If the unit is VCR recording mode when the DVD Instant Timer Recording ends, the unit will not automatically power off.

To record one TV program while watching another

1. Press TV/VCR to select the TV mode during recording. The TV indicator appears.
2. Using the TV, select the channel to be viewed.

Tip (VCR mode only)

Always use PAUSE/STEP (II) for best results when making changes during recording .

For example: To change channels during recording, first press PAUSE/STEP (II) to put the unit in pause mode. Then select the desired channel on the Recorder, and press PAUSE/STEP (II) again to resume recording.

Timer Recording

The Timer Recording function allows you to record up to 8 programs within a period of one month.

1. Press TIMER REC.
The Timer Record menu will appear.

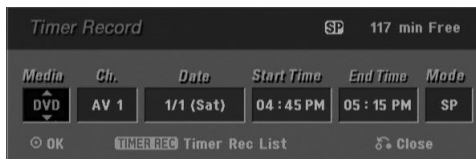

- [Media] – Choose a media (DVD or VCR).
 - [Ch.] – Choose a channel (2-69 or 1-125 for antenna or cable channels respectively, excluding skip channels), or one of the external inputs from which to record (AV1 or AV2).
 - [Date] – Choose a date up to 1 month in advance, or select a daily or weekly program.
 - [Start Time] – Set the recording start time.
 - [End Time] – Set the recording end time.
 - [Mode] – Choose a record mode.
DVD: EP, LP, SP, XP, or AT (Auto)
VCR: SP, SLP, or AT (Auto)
AT(Auto) mode determines how much time is available on the disc or tape and switches record mode, if necessary, to complete recording the program.
2. Enter the necessary information for your timer recording(s).
 - ◀ / ▶ (left/right) – Move the cursor left/right
 - ▲ / ▼ (up/down) – Change the setting at the current cursor position
 - Press RETURN (↵) to exit the Timer Record menu.
 - Press TIMER REC to display Timer Record List.

3. Press ENTER to save the program.
The Timer Record List will appear.
4. Press RETURN (↵) to exit the Timer Record List.

Notes:

- The Timer indicator lights on the front panel display.
- If the Disc and Tape indicator are blinking, either no disc or tape is loaded, or the loaded disc is not recordable.
- The Recorder will record the audio according to the current TV tuner setting (Stereo, Mono or SAP). Use the AUDIO button to set the audio before switching the Recorder to Standby mode.
- The Recorder will automatically power off when the Timer Recording ends.
- If the unit is DVD mode when the VCR timer recording ends, the unit will not automatically power off.
- There is a short delay when a timer recording finishes to confirm the recorded program. If two timer recordings are set to record sequentially (one right after the other), the very beginning of the later program may not be recorded.
- You must press STOP (■) to stop the Timer Recording.

Checking Timer Recording Details

Programming can be checked whenever the Recorder is turned on. Press TIMER REC twice.

- Use ▲ / ▼ to select a timer recording.
- Press ENTER to edit the selected program.
Timer Record menu appears.



Canceling a Timer Recording

You can clear a timer setting anytime before the recording actually starts.

- Use ▲ / ▼ to select a program you want to erase on the Timer Recorder List, then press CLEAR and select [Yes] than press ENTER.

Timer Recording Troubleshooting

Even though the timer is set, the recorder will not record when:

- There is no disc (or tape) loaded.
- A non-recordable disc (or tape) is loaded.
- Disc Protect is set to ON in the Disc menu (see page 24).
- There are already 99 titles (DVD-RW, DVD-R) or 49 titles (DVD+RW, DVD+R) recorded on the disc.

You cannot enter a timer program when:

- A recording is already underway.
- The time you're trying to set has already passed.
- There are already 8 timer programs set.

If two or more timer programs overlap:

- The earlier program takes priority.
- When the earlier program finishes, the later program starts.
- If two programs are set to start at exactly the same time, the program entered first takes priority.

If the disc is damaged, the recording may not complete successfully. In this case even though the Check field shows [Rec. OK], it may not be.

Additional Information

Simultaneous Play and Record

You can play or record DVD during the VCR playing or recording. During the VCR recording or playing, press DVD, then you can play or record a DVD.

Notes:

- You cannot playback both DVD and VCR at the same time.
- If you wish VCR playback or record during the DVD playback, press VCR to change to VCR mode and perform the VCR playback or recording.
- You can not change VCR mode during the DVD recording mode.

Dubbing from DVD to VCR

You can copy the contents of a DVD to a VHS tape using the DUBBING (or DUB) button.

1. Insert a blank VHS videotape into the VCR deck.
2. Insert the disc you wish to copy in the DVD deck and close the disc tray.
3. Find the place on the DVD (or Disc) from which you want to start dubbing using the PLAY, FF, REW and PAUSE functions.
For best results, pause playback at the point from which you want to record.
4. Press the DUBBING button on the Remote Control or DUB on the front panel.
The Dubbing menu appears.

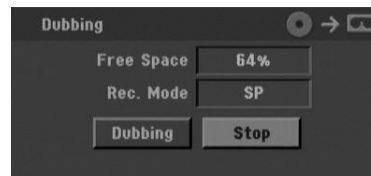

5. Use ▲ / ▼ / ◀ / ▶ to select the desired Record Mode: SP or SLP (3 times SP).
6. Select [Dubbing] then press ENTER or DUBBING to start copying.
7. To stop dubbing at any other time, press STOP (■).
You must stop the dubbing process manually when the DVD movie ends, or the unit may replay and record over and over again.

Note:

If the DVD (or Discs) you are attempting to copy is copy protected, you will not be able to copy the disc. It is not permitted to copy Macrovision encoded DVDs (or Discs). [Copy-protected. Cannot record.] is displayed on the TV screen.

Tip:

If you press PAUSE during Dubbing mode, both the DVD and VCR decks go into Pause mode and the [DUB] indicator blinks on the front panel display. While in Pause mode, you can adjust the DVD playback position using PLAY, REW, FF, PAUSE/STEP, etc. The VCR deck will remain in Pause mode. To resume Dubbing, press the DUBBING button twice.

Dubbing from VCR to DVD

You can copy the contents of a VHS tape to a DVD using the DUBBING (DUB) button. This allows you to archive your old VHS tapes to DVD.

1. Insert a blank DVD disc in the DVD deck and close the disc tray.
2. Insert the VHS video tape you wish to copy into the VCR deck.
3. Find the place on the VHS tape from which you want to start dubbing using the PLAY, FF, REW and PAUSE functions. For best results, pause playback at the point from which you want to record.
4. Press the DUBBING button on the Remote Control or DUB on the front panel. The Dubbing menu appears.



5. Use ▲ / ▼ / ◀ / ▶ to select the desired Record Mode: EP, LP, SP or XP.
6. Select [Dubbing] then press ENTER or DUBBING to start copying.
7. To stop dubbing at any other time, press STOP (■). Dubbing will stop automatically when the VHS tape ends.

Note:

If the VHS video tape you are attempting to copy is copy protected, you will not be able to copy the tape. It is not permitted to copy Macrovision encoded tapes.

Tip:

If you press PAUSE during Dubbing mode, both the DVD and VCR decks go into Pause mode and the [DUB] indicator blinks on the front panel display. While in Pause mode, you can adjust the VCR playback position using PLAY, REW, FF, PAUSE/STEP, etc. The DVD deck will remain in Pause mode. To resume Dubbing, press the DUBBING button twice.

Recording from External Components

You can record from an external component, such as a camcorder or VCR, connected to any of the Recorder's external inputs.

1. Make sure that the component you want to record from is connected properly to the Recorder. See page 17.
2. Press INPUT repeatedly to select the external input to record from.
 - AV1: Audio/Video Input mounted on back panel.
 - AV2: Audio/Video Input mounted on front panel.
3. Load a recordable disc or tape.
4. Set a recording mode as necessary by pressing REC MODE repeatedly.
DVD: XP, SP, LP or EP.
VCR: SP or SLP
5. Press ● REC once to start recording. The REC indicator lights in the display window.
6. Press STOP (■) to stop recording.

Notes:

- If your source is copy-protected using CopyGuard, you will not be able to record it using this recorder. See [Copyright] on page 9 for more details.
- Recording continues until you press STOP (■) or the disc is full.
- To record for a fixed length of time, see Instant Timer Recording on page 34.

Editing

Title List and Chapter List Menu Overview

Using the Title List menu you can edit video content. The editing features available in the Title List menu depend on whether you are editing video on DVD, and whether you're editing Original content, or a Playlist.

There are two ways to edit VR mode DVD-RW discs. You can directly edit the Original content of the disc, or you can create and edit a Playlist. The Playlist doesn't actually change any of the content on the disc, but just controls how the content is played back.

1. Press DISC MENU/LIST to display the Title List menu.
Playback should be stopped when you do this.
 - When selecting titles, use the ▲ / ▼ buttons to display the previous/next page if there are more than six titles.
 - If you are editing a VR mode disc, press DISC MENU/LIST to switch between Original and Playlist menu.
 - On the left side of the screen are the menu options. The main part of the screen shows thumbnails of the titles (or chapter) on the DVD. You can change these thumbnails using the THUMBNAIL button. (see [Changing Title Thumbnails] on page 39.)
 - Press DISPLAY to display the information of selected title on the Title List menu.
 - After selecting a title or chapter on the Title List of Chapter List menu, then press ENTER. The menu options on the left side of the menu. Use ▲ / ▼ to select a option then press ENTER to confirm your selection.
2. To exit the Title List menu, press RETURN (↵) repeatedly.

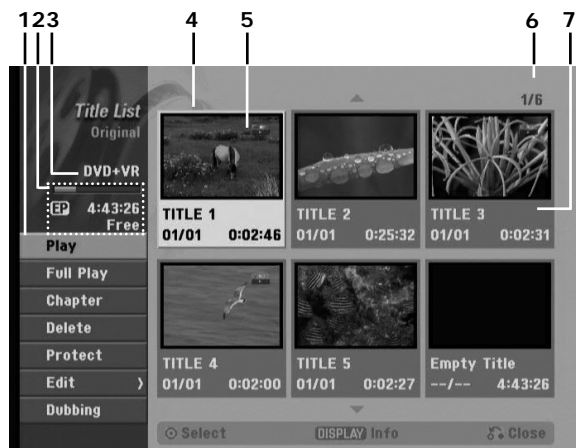

1. Menu options: To display menu option, select a title or chapter then press ENTER. The options displayed differ depending on the disc type.
 - [Play] Start playback of the selected title or chapter. The hidden titles and chapters on the DVD+R/RW cannot be play back.
 - [Chapter] Displays Chapter List of the title.
 - [Delete] Deletes the title or chapter. (page 41)
 - [Move] Moves chapter position on [chapter List-playlist] menu (page 42).
 - [Protect] Protects accidental recording, editing or deleting of the title (page 44).
 - [Edit] Edits or Deletes a part of the title.
 - [Title Name] Edits the title name. (page 42)
 - [Delete Part] Deletes a part of the Title (page 41).
 - [Playlist Add] Adds the title or chapter to the Playlist. (page 40)
 - [Title] Displays Title List of the chapter.
 - [Combine] Combines two titles or chapters into one (page 43).
 - [Divide] Divides a title into two (page 43).
 - [Full Play] Starts playback of the selected title including the hidden chapters.
 - [Hide (Show)] Hides (or Shows) the selected title or chapter. (page 44)
 - [Dubbing] Dubs the title to VCR.
2. Indicates the record mode, free space, and elapsed time progress bar.
3. Current media.
4. Currently selected title.
5. Thumbnail.
6. Shows the selected title number and total number of titles.
7. Shows the title name, recorded date, and recording length.

VR Mode: Original and Playlist Editing

Titles, Chapters and Parts

Titles in the disc's original content contain one or more chapters. When you insert a disc's title into the Playlist, all the chapters within that title also appear. In other words, chapters in the Playlist behave exactly as chapters on a DVD-Video disc do. Parts are sections of Original or Playlist titles. From the Original and Playlist menu you can add or delete parts. Adding a chapter or title to the Playlist creates a new title made up of a section (ie., chapter) of an Original title. Deleting a part removes part of a title from the Original or Playlist menu.

Caution

- When editing using the Delete, Add and Move functions, the start and end frames may not be exactly as set in the start and end point display.
- During Playlist playback, you may notice a momentary pause between edits. This is not a malfunction.

Is editing a DVD like editing a video tape?

No. When you edit a video tape you need one video deck to play the original tape and another to record the edits. With DVD, you edit by making a 'Playlist' of what to play and when to play it. On playback, the Recorder plays the disc according to the Playlist.

About words 'Original' and 'Playlist'

-RWVR

Throughout this manual, you will often see the words Original and Playlist to refer to the actual content and the edited version.

- **Original:** content refers to what's actually recorded on the disc.
- **Playlist:** content refers to the edited version of the disc — how the Original content is to be played.

Adding Chapter Markers

Chapter -RWVR +RW +R

You can create chapters within a title by inserting chapter marks at the desired points.

Note:

Chapter markers are inserted at regular intervals automatically. You can change this interval from the Initial Setup menu (see [Auto Chapter] on page 23).

During recording or playing back, at the point you want to start a new chapter, press CHP. ADD. A chapter marker icon appears on the TV screen.

Changing Title Thumbnails

Thumbnail -RWVR +RW +R

Each title displayed in the Title List menu is represented by a thumbnail picture taken from the start of that title or chapter.

If you prefer, select a different still picture from within a title.

Press THUMBNAIL to make the currently displayed picture the one that appears in the Title List menu. The still picture that you choose appears in both the Original or Playlist menu.

Making a New Playlist

-RW/VR

Use this function to add an Original title or chapter to the Playlist. When you do this, the whole title is put into the Playlist (you can delete bits you don't need later - see [Deleting an Original or Playlist title/chapter] on page 41).

The title appears in the Playlist complete with the chapter markers that appear in the Original. However, if you add more chapter markers to the Original later, these are not automatically copied over into the Playlist title.

1. Choose a title or chapter on the [Title List-Original] menu or [Chapter List-Original] menu to put into the Playlist, then press ENTER. The menu options appears on the left side of the screen.



2. Use ▲ / ▼ to select [Playlist] option then press ENTER.



3. Select [New Playlist] then press ENTER. The new title appears in the updated Playlist. All chapters of the title are added to the Playlist.

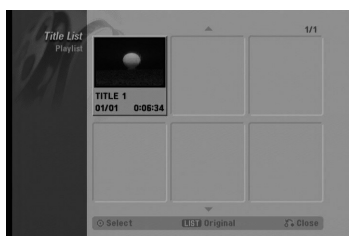

Adding Additional Title / Chapters to the Playlist

-RW/VR

You can add an Original title or chapter to add to a Playlist title even if it is already registered.

1. Choose a title or chapter on the [Title List-Original] menu or [Chapter List-Original] menu to put into the Playlist, then press ENTER. The menu options appears on the left side of the screen.



2. Use ▲ / ▼ to select [Playlist] from menu options then press ENTER.



3. Choose a Title List-Playlist that is already registered to insert a title or chapter, then press ENTER.
4. Repeat steps 1-3 to add additional title or chapter on the Playlist. You can view the added chapters on the [Chapter List-Playlist] menu.



5. Press RETURN (↵) to exit, or DISC MENU/LIST to go back to the [Title List-Original] menu.

Deleting an Original or Playlist Title / Chapter

When you erase a title or chapter from the Playlist menu, you only remove it from the Playlist; the title/chapter remains in the Original menu.

If you choose to delete a title or chapter from the Original (title/chapter) menu, the title or chapter is actually deleted from the disc and the remaining time available for recording increases. Titles/chapters deleted from the Original are also removed from the Playlist.

Note:

It may not be possible to delete chapters that are less than 5 seconds long.

1. Use ◀ / ▶ / ▲ / ▼ to choose a chapter or title you want to delete on the [Title List] or [Chapter List] menu then press ENTER. The menu options appears on the left side of the screen.
2. Select [Delete] option from the options on the menu.

Example: Title List (DVD-VR)



3. Press ENTER to confirm. The confirm message for deleting will appear.
4. Use ◀ / ▶ to select [Yes] then press ENTER. The selected chapter or title is deleted. After pressing ENTER, the new, updated menu is displayed.
5. Repeat steps 1 - 4 to continue to delete from the menu.
6. Press RETURN (↵) repeatedly to exit the menu.

Notes:

- When DVD+RW recording, the deleted title's name is changed to [Deleted Title].
- If more than two titles are repeatedly deleted, the titles are combined into one.
- When you are deleting a title or chapter, only the last one on DVD+R/RW increases remaining recording time.

Deleting a Part **-RW/VR**

You can delete a part which you do not want in the title.

1. Use ◀ / ▶ / ▲ / ▼ to choose a title you want to delete on the Title List menu then press ENTER. The options appears on the left side of the menu.
2. Select [Delete Part] option then press ENTER. [Title Edit (Delete Part)] menu appears on the TV screen. [Start Point] icon is highlighted.

Example: Title Edit (Delete Part) (DVD-VR)



3. Starts playback and use pause step, search and slow-motion to find the starting point.
4. Press ENTER at the starting point of the section you want to delete. [End Point] icon is highlighted. The part is indicated on the Progress Bar.
5. Use pause step, search and slow-motion to find the ending point.
6. Press ENTER at the ending point of the section you want to delete. You can cancel the selected point, use ▲ / ▼ to select [Cancel] icon then press ENTER.
7. If you finish to edit, select [Done] icon then press ENTER. The confirm message for deleting will appear. Use ◀ / ▶ to select [Yes] then press ENTER. The selected part is deleted from the title and Title List menu appears.

Notes:

- It may not be possible to delete parts that are less than 1 seconds long.
- If you select [Cancel] then press ENTER, the Recorder will go to previous option and into Pause mode.

Naming a Title

You can name Original and Playlist titles independently.

1. Choose the title you want to name on the Title List menu, then press ENTER.
The menu options appears on the left side of the menu.
2. Use ▲/▼ to select [Title Name] option then press ENTER.
Keyboard menu appears.



3. Enter a name for the title. Use ◀ / ▶ / ▲ / ▼ to select a character then press ENTER to confirm your selection.
 - **Alphabet Capital:** Switches the keyboard to upper case characters.
 - **Alphabet Small:** Switches the keyboard to lower case characters.
 - **Symbol:** Switches the keyboard to symbol characters.
 - **Space:** Inserts a space at the cursor position.
 - **Delete:** Deletes the character to the left of the cursor position.
 - **◀ / ▶:** Moves the cursor left or right.
 - **OK:** Confirms the name you have entered.
 - **Cancel:** Deletes all characters and exits the Keyboard menu.
4. Choose [OK] then press ENTER to fix the name and return to the previous menu screen.
5. Press RETURN (↵) repeatedly to exit the menu.

Notes:

- Names can be up to 32 characters long.
- For discs formatted on a different recorder, you will see only a limited character set.
- When recording on DVD-R, DVD+R or DVD+RW discs, the entered name is displayed on the DVD player only after finalization.

Moving a Playlist Chapter

-RWVR

Use this function to re-arrange the playing order of Playlist chapters on the [Chapter List-Playlist] menu.

Note:

This function is not available if there is only one chapter.

1. Select a chapter on the [Chapter List-Playlist] menu.
2. Press ENTER.
The menu options appears on the left side of the menu.
3. Use ▲ / ▼ to select [Move] option from Playlist options then press ENTER.



4. Use ◀ / ▶ / ▲ / ▼ to choose the place you want to move the chapter then press ENTER.
After pressing ENTER, the updated menu is displayed.

Divide One Titles Into Two

+RW

Use this command to split a title up into two new titles.

1. On the Title List menu, select a title you want to divide then press ENTER. The menu options appears on the left side of the screen.
2. Select [Divide] option.
Example: Title List (DVD+RW)



3. Press ENTER. [Title Edit (Divide)] menu appears. [Divide] option is highlighted.

Current picture



The first title's thumbnail

The second title's thumbnail

4. Use play, pause step, search and slow-motion to find the point you want to divide the title.
5. Select [Divide] option then press ENTER at the point.
To reset the point, select [Cancel] option then press ENTER. Repeat from step 3.
6. Choose [Done] option then press ENTER to fix the dividing point.
The title is divided into two new titles. It take up to 4 minutes to divide.

Note:

You cannot select dividing point less than 3 seconds.

Combining Two Chapters Into One

-RW/VR +RW +R

Use this function to combine two adjacent chapters into one.

1. On the Chapter List menu, select the second chapter of the two chapters you want to combine then press ENTER. The menu options appears on the left side of the screen.
2. Use ▲ / ▼ to select [Combine] option.
The combine indicator appears between the two chapters you want to combine.

Example: Chapter List (DVD+RW)



3. Repeat steps 1 - 2 to continue to combine from the menu.
4. Press RETURN (↵) repeatedly to exit the menu.

Notes:

This function cannot operate listed as below;

- If there is only one chapter within the title.
- If you select last chapter.
- If the chapter has been hidden.

Hide a Chapter

+RW **+R**

You can skip playing chapters without deleting from the disc.

1. Use **▲▼◀▶** to choose a chapter you want to hide on the [Chapter List] menu, then press **ENTER**.
Options appear on the left side of the screen.
2. Select [Hide] option.

Example: Chapter List (DVD+RW)



3. Press **ENTER** to confirm.

Tip:

If you select a hidden chapter on the [Chapter List] menu, you can 'show' it by choosing [Show] option on the menu. After doing that, you are able to see the chapter.

Protect a Title

+RW **+R**

Use this function to protect against accidental recording, editing or deleting of the title.

1. Press **DISC MENU/LIST** to display the [Title List] menu.
2. Use **▲▼◀▶** to choose a title you want to protect then press **ENTER**.
Options appear on the left side of the screen.
3. Select [Protect] from the options.

Example: Title List (DVD+RW)



4. Press **ENTER** to confirm.
The lock mark will appear on the title's thumbnail.

Tip:

If you select a title that has already been protected on the Title List menu, you can 'unprotect' it by choosing [Protect] option from the Title List menu options. After doing that, you can edit and delete the title.

Overwriting Recording **+RW**

To overwrite a new video recording on a previously recorded title, follow these steps. This feature is not available for DVD+Rs, that always record at the end of the Disc.

1. Select input source you want to record (TV channel, AV1-2).
2. Press DISC MENU/LIST to display the Title List menu.



3. Use ▲▼◀▶ to choose a title you want to overwrite.
4. Press ● REC to start overwrite recording. Overwrite recording starts from the start point of the title.
5. Press STOP (■) to stop the overwrite recording. The new title is created and updated menu is displayed.

Notes:

- This function is not available for a protected title.
- **If the overwrite is longer than the recording length of the current title, the next title is overwritten. But if next title is protected, the overwriting stops at the starting point of the title.**

Viewing Title List menu displayed on other DVD Recorders or Players

+RW **+R**

You can view the Title List menu displayed on the other DVD player that is capable of playing DVD+RW or DVD+R discs.

1. Insert DVD+R or DVD+RW disc recorded already.

2. Press TITLE in Play mode or DVD tuner mode. Title List menu will appear as shown below.



3. To play back a title, select the title you want then press ENTER or PLAY (▶).

Tip:

You can remove the Title List menu by pressing STOP (■).

Playing Your Recordings on Other DVD Players (Finalizing a Disc)

Most regular DVD players can play finalized discs recorded in Video mode, finalized DVD+R or DVD+RWs. A small number of players can also play DVD-RW discs recorded in VR mode, finalized or not. Check the manual that came with the other player to check what formats of discs it will play.

Finalizing 'fixes' the recordings and editings in place so that the disc can be played on a regular DVD player or computer equipped with a suitable DVD-ROM drive.

Finalizing a Video mode disc creates a menu screen for navigating the disc. The menu can be accessed by pressing DISC MENU/LIST or TITLE.

To finalize a disc, refer to [Finalize] on page 24.

Notes:

- Unfinalized DVD+RW is playable on regular DVD players.
- The edited contents of a DVD+RW disc is compatible on regular DVD players only after finalization.
- Any edited contents of the DVD+R disc are not compatible on regular DVD players. (Hide, chapter combine, added chapter mark, etc.)
- How long finalization takes depends on the type of disc, how much is recorded on the disc, and the number of titles on the disc.

Reference

Controlling Your TV with the Supplied Remote Control

You can control the sound level, input source, and power switch of your LG TV with the supplied remote.

You can control your TV using the buttons below.

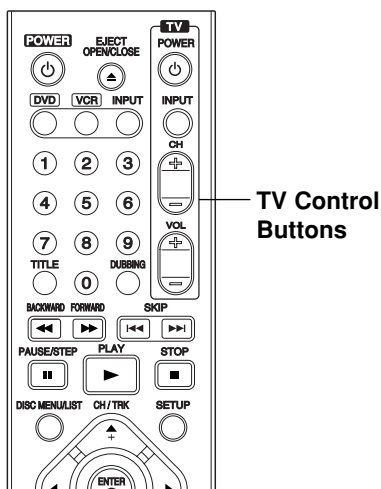

By pressing	You can
POWER	Turn the TV on or off.
INPUT	Switch the TV's input source between the TV and other input sources.
CH +/-	Scans up or down through memorized channels.
VOL +/-	Adjust the volume of the TV.

Controlling other TVs with the remote

You can control the sound level, input source, and power switch of non-LG TVs as well. If your TV is listed in the table below, set the appropriate manufacturer code.

1. While holding down TV POWER button, press the number buttons to select the manufacturer code for your TV (see the table below).
2. Release TV POWER button.

Code numbers of controllable TVs

If more than one code number is listed, try entering them one at a time until you find the one that works with your TV.

Manufacturer	Code Number
LG / GoldStar	1 (Default), 2
Zenith	1, 3, 4
Samsung	6, 7
Sony	8, 9
Hitachi	4

Notes:

- Depending on your TV, some or all buttons may not function on the TV, even after entering the correct manufacturer code.
- If you enter a new code number, the code number previously entered will be erased.
- When you replace the batteries of the remote, the code number you have set may be reset to the default setting. Set the appropriate code number again.

Language Codes

Use this list to input your desired language for the following initial settings: Disc Audio, Disc Subtitle, Disc Menu.

Language	Code	Language	Code	Language	Code	Language	Code
Abkhazian	6566	Fiji	7074	Lingala	7678	Singhalese	8373
Afar	6565	Finnish	7073	Lithuanian	7684	Slovak	8375
Afrikaans	6570	French	7082	Macedonian	7775	Slovenian	8376
Albanian	8381	Frisian	7089	Malagasy	7771	Somali	8379
Ameharic	6577	Galician	7176	Malay	7783	Spanish	6983
Arabic	6582	Georgian	7565	Malayalam	7776	Sudanese	8385
Armenian	7289	German	6869	Maltese	7784	Swahili	8387
Assamese	6583	Greek	6976	Maori	7773	Swedish	8386
Aymara	6588	Greenlandic	7576	Marathi	7782	Tagalog	8476
Azerbaijani	6590	Guarani	7178	Moldavian	7779	Tajik	8471
Bashkir	6665	Gujarati	7185	Mongolian	7778	Tamil	8465
Basque	6985	Hausa	7265	Nauru	7865	Tatar	8484
Bengali; Bangla	6678	Hebrew	7387	Nepali	7869	Telugu	8469
Bhutani	6890	Hindi	7273	Norwegian	7879	Thai	8472
Bihari	6672	Hungarian	7285	Oriya	7982	Tibetan	6679
Breton	6682	Icelandic	7383	Panjabi	8065	Tigrinya	8473
Bulgarian	6671	Indonesian	7378	Pashto, Pushto	8083	Tonga	8479
Burmese	7789	Interlingua	7365	Persian	7065	Turkish	8482
Byelorussian	6669	Irish	7165	Polish	8076	Turkmen	8475
Cambodian	7577	Italian	7384	Portuguese	8084	Twi	8487
Catalan	6765	Japanese	7465	Quechua	8185	Ukrainian	8575
Chinese	9072	Javanese	7487	Rhaeto-Romance	8277	Urdu	8582
Corsican	6779	Kannada	7578	Rumanian	8279	Uzbek	8590
Croatian	7282	Kashmiri	7583	Russian	8285	Vietnamese	8673
Czech	6783	Kazakh	7575	Samoan	8377	Volapük	8679
Danish	6865	Kirghiz	7589	Sanskrit	8365	Welsh	6789
Dutch	7876	Korean	7579	Scots Gaelic	7168	Wolof	8779
English	6978	Kurdish	7585	Serbian	8382	Xhosa	8872
Esperanto	6979	Laothian	7679	Serbo-Croatian	8372	Yiddish	7473
Estonian	6984	Latin	7665	Shona	8378	Yoruba	8979
Faroese	7079	Latvian, Lettish	7686	Sindhi	8368	Zulu	9085

Area Codes (Country Codes)

Choose a area code (country code) from this list.

Area (Country)	Code	Area (Country)	Code	Area (Country)	Code	Area (Country)	Code
Afghanistan	AF	Ethiopia	ET	Malaysia	MY	Saudi Arabia	SA
Argentina	AR	Fiji	FJ	Maldives	MV	Senegal	SN
Australia	AU	Finland	FI	Mexico	MX	Singapore	SG
Austria	AT	France	FR	Monaco	MC	Slovak Republic	SK
Belgium	BE	Germany	DE	Mongolia	MN	Slovenia	SI
Bhutan	BT	Great Britain	GB	Morocco	MA	South Africa	ZA
Bolivia	BO	Greece	GR	Nepal	NP	South Korea	KR
Brazil	BR	Greenland	GL	Netherlands	NL	Spain	ES
Cambodia	KH	Islands	HM	Netherlands Antilles	AN	Sri Lanka	LK
Canada	CA	Hong Kong	HK	New Zealand	NZ	Sweden	SE
Chile	CL	Hungary	HU	Nigeria	NG	Switzerland	CH
China	CN	India	IN	Norway	NO	Taiwan	TW
Colombia	CO	Indonesia	ID	Oman	OM	Thailand	TH
Congo	CG	Israel	IL	Pakistan	PK	Turkey	TR
Costa Rica	CR	Italy	IT	Panama	PA	Uganda	UG
Croatia	HR	Jamaica	JM	Paraguay	PY	Ukraine	UA
Czech Republic	CZ	Japan	JP	Philippines	PH	United States	US
Denmark	DK	Kenya	KE	Poland	PL	Uruguay	UY
Ecuador	EC	Kuwait	KW	Portugal	PT	Uzbekistan	UZ
Egypt	EG	Libya	LY	Romania	RO	Vietnam	VN
El Salvador	SV	Luxembourg	LU	Russian Federation	RU	Zimbabwe	ZW

Troubleshooting

Check the following guide for the possible cause of a problem before contacting service.

Symptom	Cause	Correction
No power.	<ul style="list-style-type: none"> The power cord is disconnected. 	<ul style="list-style-type: none"> Plug the power cord into the wall outlet securely.
No picture.	<ul style="list-style-type: none"> The TV is not set to receive Recorder signal output. 	<ul style="list-style-type: none"> Select the appropriate video input mode on the TV so the picture from the Recorder appears on the TV screen.
	<ul style="list-style-type: none"> The video cable is not connected securely. 	<ul style="list-style-type: none"> Connect the video cable into the jacks securely.
	<ul style="list-style-type: none"> The Progressive Scan is set to On on the setup menu but is connected to a standard(analog) television with component video input. 	<ul style="list-style-type: none"> Set Progressive Scan to [OFF] (see page 20).
	<ul style="list-style-type: none"> Wrong connection. 	<ul style="list-style-type: none"> Check the connection.
No sound.	<ul style="list-style-type: none"> The equipment connected with the audio cable is not set to receive Recorder signal output. 	<ul style="list-style-type: none"> Select the correct input mode of the audio receiver so you can listen to the sound from the Recorder.
	<ul style="list-style-type: none"> The audio cables are not connected securely. 	<ul style="list-style-type: none"> Connect the audio cable into the jacks securely.
	<ul style="list-style-type: none"> The power of the equipment connected with the audio cable is turned off. 	<ul style="list-style-type: none"> Turn on the equipment connected with the audio cable.
	<ul style="list-style-type: none"> The AUDIO options are set to the wrong position. 	<ul style="list-style-type: none"> Set the AUDIO options to the correct position.
The playback picture is poor.	<ul style="list-style-type: none"> The disc is dirty. 	<ul style="list-style-type: none"> Clean the disc.
	<ul style="list-style-type: none"> The TV channels are not tuned in properly. 	<ul style="list-style-type: none"> Check tuning, carry out tuning again.
	<ul style="list-style-type: none"> Tape heads are dirty. 	<ul style="list-style-type: none"> Clean video heads.
	<ul style="list-style-type: none"> Tape is a rental or was recorded on another VCR. 	<ul style="list-style-type: none"> Use CH/TRK (▲/▼) for manual tracking adjustment while tape is playing.
	<ul style="list-style-type: none"> This unit can only output 525p Progressive scan picture. 	<ul style="list-style-type: none"> Make sure that your TV can support 525p Progressive scan picture or set Progressive scan to off.
Picture from external input is distorted.	<ul style="list-style-type: none"> The video signal from the external component is copy-protected. 	<ul style="list-style-type: none"> You cannot connect via the Recorder. Connect the component directly to your TV.
Some channels are skipped over when using CH (▲ / ▼).	<ul style="list-style-type: none"> The skipped channels were deleted with the CH. Add/Del feature. 	<ul style="list-style-type: none"> Use the CH. Add/Del feature to restore channels. See [To Add or Erase Channels from Memory] on page 18.

Symptom	Cause	aCorrection
The Recorder does not start playback.	<ul style="list-style-type: none"> No disc is inserted. No tape is inserted. 	<ul style="list-style-type: none"> Insert a disc or tape. (Check that the disc or tape indicator in the display window is lit.)
	<ul style="list-style-type: none"> An unplayable disc is inserted. 	<ul style="list-style-type: none"> Insert a playable disc. (Check the disc type and Regional code.)
	<ul style="list-style-type: none"> The disc is placed upside down. 	<ul style="list-style-type: none"> Place the disc with the playback side down.
	<ul style="list-style-type: none"> The disc is not placed within the guide. 	<ul style="list-style-type: none"> Place the disc on the disc tray correctly inside the guide.
	<ul style="list-style-type: none"> The disc is dirty. 	<ul style="list-style-type: none"> Clean the disc.
	<ul style="list-style-type: none"> The Rating level is set. 	<ul style="list-style-type: none"> Cancel the Rating function or change the rating level.
Video tape cannot be inserted.	<ul style="list-style-type: none"> Is the cassette compartment empty? 	<ul style="list-style-type: none"> Eject the tape in.
The remote control does not work properly.	<ul style="list-style-type: none"> There is an obstacle in the path of the remote control and this unit. 	<ul style="list-style-type: none"> Remove the obstacle.
	<ul style="list-style-type: none"> The batteries in the remote control are exhausted. 	<ul style="list-style-type: none"> Replace the batteries with new ones.
	<ul style="list-style-type: none"> The remote control is not pointed at the remote sensor of the Recorder. 	<ul style="list-style-type: none"> Point the remote control at the remote sensor of the Recorder.
	<ul style="list-style-type: none"> The remote control is too far from the Recorder. 	<ul style="list-style-type: none"> Operate the remote control within 23ft (7m).
	<ul style="list-style-type: none"> This remote control use the same buttons for VCR and DVD functions (ex.PLAY). 	<ul style="list-style-type: none"> When using a VCR, first press the VCR button. When using a DVD, first press the DVD button.
Camcorder image is not shown.	<ul style="list-style-type: none"> Camcorder is off. 	<ul style="list-style-type: none"> Turn camcorder on and operate properly.
Camcorder image via A/V input to Recorder is not shown on TV screen.	<ul style="list-style-type: none"> The recorder's source is incorrect. 	<ul style="list-style-type: none"> Use INPUT to select input channel (AV1 or AV2).
Timer recording is not possible.	<ul style="list-style-type: none"> Clock in Record is not set to correct time. 	<ul style="list-style-type: none"> Set clock to correct time.
	<ul style="list-style-type: none"> Timer has been programmed incorrectly. 	<ul style="list-style-type: none"> Reprogram Timer.
	<ul style="list-style-type: none"> Ⓢ (TIMER) indicator light does not appear after programming timer. 	<ul style="list-style-type: none"> Reprogram Timer and turn Record off to enable timer.

Symptom	Cause	Correction
Picture or sound of broadcasting channel is weak or missing.	<ul style="list-style-type: none"> • Antenna or cables are loose. 	<ul style="list-style-type: none"> • Tighten connections or replace cable.
	<ul style="list-style-type: none"> • Wrong Tuning Band is selected in the Recorder Setup menu. 	<ul style="list-style-type: none"> • Try [Tuning Band Select] options; see page 18 for details.
Can't play disc recorded on this Recorder on another DVD player.	<ul style="list-style-type: none"> • The disc was recorded in Video mode. 	<ul style="list-style-type: none"> • Finalize the disc; see page 24.
	<ul style="list-style-type: none"> • Some players will not play even a finalized disc recorded in Video mode. 	<ul style="list-style-type: none"> • No solution.
	<ul style="list-style-type: none"> • The disc was recorded in VR mode. 	<ul style="list-style-type: none"> • The other player must be RW compatible in order to play it.
	<ul style="list-style-type: none"> • Discs recorded with copy-once material cannot be played on other players. 	<ul style="list-style-type: none"> • No solution.
Cannot record or did not record successfully.	<ul style="list-style-type: none"> • The remaining blank space on the disc is insufficient. 	<ul style="list-style-type: none"> • Use another disc.
	<ul style="list-style-type: none"> • The source you are trying to record is copy-protected. 	<ul style="list-style-type: none"> • You cannot record the source.
	<ul style="list-style-type: none"> • When setting the recording channel, the channel is tuned on the TV's own tuner. 	<ul style="list-style-type: none"> • Select the channel on the Recorder's built-in TV tuner.
	<ul style="list-style-type: none"> • When recording to a Video mode disc, programs that are copy-once protected cannot be recorded. 	<ul style="list-style-type: none"> • Use a VR mode formatted disc for copy-once material.
Stereo Audio Record and/or Playback not present.	<ul style="list-style-type: none"> • TV is not Stereo-compatible. 	<ul style="list-style-type: none"> • No solution.
	<ul style="list-style-type: none"> • Broadcast program is not in stereo format. 	<ul style="list-style-type: none"> • No solution.
	<ul style="list-style-type: none"> • Recorder A/V Out jacks are not connected to TV A/V In jacks. 	<ul style="list-style-type: none"> • Make A/V connections. Stereo is available only via A/V output from Recorder.
	<ul style="list-style-type: none"> • Recorder Audio/Video Out is not selected for viewing at the TV. 	<ul style="list-style-type: none"> • Select AUX or A/V source as TV input.
	<ul style="list-style-type: none"> • Recorder's TV audio channel is set to SAP or MONO. 	<ul style="list-style-type: none"> • Set TV audio channel mode to Stereo. See [Changing TV Audio Channel] on page 25.

Reset the Recorder

If you observe any of the following symptoms...

- When the Recorder is plugged in, but the power will not turn on or off.
- When the display window does not working.
- When the Recorder does not operate normally.

You can reset the Recorder as follows :

- Press and hold the POWER button for more than five seconds. This will force the Recorder to power off. Press the POWER button again to turn the Recorder back on.
- Unplug the power cord and then plug the power cord again after more than five seconds.

Specifications

General

Power requirements	AC 120V, 60 Hz
Power consumption	35W
Dimensions (approx.)	430 X 78.5 X 354 mm (16.9 x 3.1 x 13.9 inches) (w x h x d)
Mass (approx.)	5.6 kg (12.32 lbs)
Operating temperature	5°C to 35°C (41°F to 95°F)
Operating humidity	5 % to 90 %
Signal system	NTSC

Recording

Recording format	DVD VideoRecording, DVD-VIDEO
Recordable discs	DVD-ReWritable, DVD-Recordable, DVD+ReWritable, DVD+Recordable
Recordable time	DVD ; Approx. 1 hour (XP mode), 2 hours (SP mode), 4 hours (LP mode), 6 hours (EP mode) VCR ; SP: 2 HOURS (T-120), SLP: 6 HOURS (T-120)/8 HOURS (T-160)

Video recording format

Sampling frequency	27MHz
Compression format	MPEG 2

Audio recording format

Sampling frequency	48kHz
Compression format	Dolby Digital

VCR Specifications

Head system	Four head helical scan azimuth system
Timer	12-hour display type with AM, PM
Tape speed	SP: 33.35 mm/sec, LP: 16.67 mm/sec, SLP: 11.12 mm/sec
Tape width	12.7 mm
Rewind time	About 65 seconds (T-120)
Antenna	75 ohms (VHF/UHF)
VHF output signal	Channel 3 or 4 (Switchable)
Channel coverage	VHF: 2-13, UHF: 14-69, CATV: 1-125 (4A, A-W, W+1 - W+84, A-5 - A-1)
Frequency range	20Hz to 20kHz
Signal-to-noise ratio	43dB
Dynamic range	88 dB
Channel separation	60 dB

DVD Specifications

Laser system	Semiconductor laser, wavelength 650 nm
Frequency response	DVD (PCM 48 kHz): 8 Hz to 22 kHz, CD: 8 Hz to 20 kHz
Signal-to-noise ratio	More than 95dB
Harmonic distortion	Less than 0.008%
Dynamic range	More than 90 dB

Inputs

ANTENNA IN	Antenna or CATV input, 75 ohms
VIDEO IN (AV1,2)	1.0 Vp-p 75 ohms, sync negative, RCA jack x 2
AUDIO IN (AV1,2)	-6 dBm more than 47 kohms, RCA jack (L, R) x 2
S-VIDEO IN	(Y) 1.0 V (p-p), 75 Ω , negative sync, Mini DIN 4-pin x 1 (C) 0.286 V (p-p) 75 Ω

Outputs

VIDEO OUT	1 Vp-p 75 Ω , sync negative, RCA jack x 1
S-VIDEO OUT	(Y) 1.0 V (p-p), 75 Ω , negative sync, Mini DIN 4-pin x 1 (C) 0.286 V (p-p) 75 Ω
COMPONENT VIDEO OUT (PROGRESSIVE SCAN)	(Y) 1.0 V (p-p), 75 Ω , negative sync, RCA jack x 1 (Pb)/(Pr) 0.7 V (p-p), 75 Ω , RCA jack x 2
Audio output (digital audio)	0.5 V (p-p), 75 Ω , RCA jack x 1
Audio output (optical audio)	Optical connector x 1
Audio output (analog audio)	1.1 Vrms (1 kHz, -6 dB), 600 Ω , RCA jack (L, R) x 2
RF OUT	Channel 3 or 4 (Switchable)

Accessory:

Video cable1	Audio cable (L, R)1
RF 75-ohm Coaxial Cable1	Remote control1
Batteries2		

Design and specifications are subject to change without notice.

Note

Note

Note



Zenith Limited Warranty - USA

This Zenith product, will be repaired or replaced, at Zenith's option, if it proves to be defective in material or workmanship, under normal use, during the warranty period ("Warranty Period") listed below, effective from the date ("Date of Purchase") of original consumer purchase of the product. This warranty is good only to the original purchaser of the product and effective only when used in the United States, excluding U.S. Territories.

WARRANTY PERIOD:	HOW SERVICE IS HANDLED:
LABOR: 90 days from the Date of Purchase.	Call 1-800-243-0000 for instructions on getting the defective unit repaired or replaced.
PARTS: One Year from the Date of Purchase.	Please retain dated sales receipt and your box to return the unit to Zenith for repair or replacement.
* Parts replaced are warranted for the remaining portion of the original warranty period.	Shipping both ways will be paid by Zenith during the first 90 days of the Warranty Period. During the remainder of the Warranty Period (91-365 days), you pay inbound shipping charges and Zenith pays return shipping charges.
	Visit our website at: http://www.zenithservice.com

THIS WARRANTY IS IN LIEU OF ANY OTHER WARRANTIES, EXPRESS OR IMPLIED, INCLUDING WITHOUT LIMITATION, ANY WARRANTY OF MERCHANTABILITY OR FITNESS FOR A PARTICULAR PURPOSE. TO THE EXTENT ANY IMPLIED WARRANTY IS REQUIRED BY LAW, IT IS LIMITED IN DURATION TO THE EXPRESS WARRANTY PERIOD ABOVE. ZENITH WILL NOT BE LIABLE FOR ANY INCIDENTAL, CONSEQUENTIAL, INDIRECT, SPECIAL OR PUNITIVE DAMAGES OF ANY NATURE, EVEN IF ADVISED OF THE POSSIBILITY OF SUCH DAMAGES, INCLUDING WITHOUT LIMITATION, LOST REVENUES OR PROFITS, LOST OR CORRUPTED PROGRAMMING OR DATA, OR ANY OTHER DAMAGE WHETHER BASED IN CONTRACT, TORT OR OTHERWISE. Some states do not allow the exclusion or limitation of incidental or consequential damages or limitation on how long an implied warranty lasts, so the above exclusion or limitation may not apply to you. This warranty gives you specific legal rights and you may also have other rights that may vary from state to state.

THIS LIMITED WARRANTY DOES NOT APPLY TO:

- Damages or operating problems that result from shipping, installation, adjustment of user controls, calibration, maintenance or failure to maintain, or separate system components; and
- Damages or operating problems that result from normal wear and tear, misuse, abuse, operation outside environmental specifications or contrary to the requirements or precautions in the Operating Guide, accident, lightning strikes or other natural causes, unauthorized modification or alteration, incorrect electrical current or voltage, signal reception or input, software not licensed directly by LG, software errors that do not disable functionality, operating and software protocols adopted after the date of manufacture or for outside the US, institutional or commercial use, or other causes not arising out of defect in material or workmanship.

The cost of repair or replacement under these excluded circumstances shall be borne by the consumer.

CUSTOMER INTER-ACTIVE CENTER NUMBERS:

For Warranty Service, Where to buy, Product Assistance, or Customer Assistance	Call 1-800-243-0000 (24 hours a day, 365days per year) and select appropriate options from the menu. Or visit our website at http:// www.zenithservice.com To contact us by mail: LG Customer Interactive Center PO Box 240007 201 James Record Road Huntsville, AL 35824 Attn CIC
---	---

Marketed and distributed by:
LG ELECTRONICS U.S.A., INC.
1000 SYLVAN AVENUE
ENGLEWOOD CLIFFS, NJ

P/N : 3835RV0040H
Issue O
Printed in Indonesia

Free Manuals Download Website

<http://myh66.com>

<http://usermanuals.us>

<http://www.somanuals.com>

<http://www.4manuals.cc>

<http://www.manual-lib.com>

<http://www.404manual.com>

<http://www.luxmanual.com>

<http://aubethermostatmanual.com>

Golf course search by state

<http://golfingnear.com>

Email search by domain

<http://emailbydomain.com>

Auto manuals search

<http://auto.somanuals.com>

TV manuals search

<http://tv.somanuals.com>