

**Use & Care Guide
Tumble Dryer
MAYTAG
MDE 9901**



CONTENTS

READ FIRST	Page
1 Before tumble drying for the first time	3
2 Safety instructions General, Installation, Safety, Interrupting a programme, Transport/Winter storage, Packing materials, Disposal	4
3 Child safety General, Child lock	5
4 Parts of the tumble dryer	7
5 Panel	8
6 LC display	8

INSTALLATION

See Installation Instructions

TUMBLE DRYING

7 Before tumble drying Spin-dried?, Washing instructions, Sorting fabrics, Programmes, Options, Temperature, Drying time	9-11
8 Tumble dry Tumble drying, Instructions – step-by-step, Automatic draining	12-15
9 Consumption values – pre-set drying programmes	16
10 Making your own drying programmes General, Available settings and options, Available programmes, Create your own drying programme, Interrupt input, Reset programme, Menu system for altering pre-set programmes	17-21

CARE	Page
11 Care and cleaning Cleaning the lint filter, Draining the condensation water container, Cleaning the outside of the dryer, Cleaning the fan, Cleaning the condenser	23-25

PROBLEMS?

12 Trouble shooting Dryer will not start, Overheating protection, No interior lighting, Drying takes too long, Fault messages, Wrong language on the display, Stop flashes in the display, Reset programme	26-28
----------------------------------------------------------------------------------------------------------------------------------------------------------------------------------------------------------------------	-------

MISCELLANEOUS

13 Technical information Technical data, Standard tests	29
14 Service and guarantee	30
15 Index	31
16 Quick guide	32

1 BEFORE TUMBLE DRYING THE FIRST TIME

READ THE OPERATING INSTRUCTIONS

Please read through this Use and Care Guide before attempting to use the machine, particularly Chapter 2, Safety instructions, and 3, Children's safety.

DO NOT TUMBLE-DRY

Some fabrics are sensitive to tumble drying. Check the Recommended washing marking on the items concerned, and study Chapter 7, Before tumble drying.

NOTE

When you start the tumble dryer the first time, or after a long period when it has not been in use, you may hear a light rumbling noise. This is quite normal and the sound will disappear after a few drying operations.

For brief operating instructions; see Chapter 16, Quick guide.

2 SAFETY INSTRUCTIONS



GENERAL

- Study and save this Use and Care Guide for future reference.
- Electrical installation, if required, must be carried out by an authorized electrician.
- The machine may only be used for tumble drying in accordance with this Use and Care Guide.
- Repairs and maintenance which affect safety or performance must be carried out by an authorized specialist.
- Damaged mains cables must only be replaced by an authorised professional.
- Sufficient ventilation is required to prevent smoke from open fires or fumes from equipment burning other fuels being sucked into the room.

INSTALLATION

See the accompanying installation instructions.

SAFETY



This machine may not be used for drying fabrics that have been dry-cleaned at home, or which can be suspected of containing residues of flammable fluids.

The tumble dryer is fitted with an overheating protection device, which switches the machine off in the event of excessive temperature.

A float valve switches the machine off if the condensation water hose becomes clogged, or if there is danger of water flowing over from the container.

INTERRUPTING THE PROGRAMME

A drying programme can be interrupted by pres-

sing the main switch, , or by opening the door causing the drum to stop automatically. The machine will “remember” where in the programme it was when stopped. If you wish to continue the drying process, just close the door and press the  -button and the machine will start where it was interrupted.

You can also interrupt a programme by pressing  for three seconds. However, if you stop the machine in this way it will forget where it was in the programme and you will have to select a programme to restart.

TRANSPORT/WINTER STORAGE

If the machine is to be transported or stored during the winter, on unheated premises, ensure that the water container is drained.

PACKING MATERIAL

Sort the packing material for recycling according to recommendations by the local authorities.

DISPOSAL

When the machine is no longer useful and is to be scrapped it should be made unusable.

Get in touch with the refuse collection service or your local authorities for advice on how to scrap the machine in a proper manner.

The machine is made and marked to facilitate recycling.

CAUTION!



During the programme, the back of the tumble dryer will get very hot. Leave the machine to cool completely before touching the back.

3 CHILDREN'S SAFETY





GENERAL

Do not allow children to play with the tumble dryer.



The tumble dryer is fitted with a magnetic catch, which allows the door to be opened from the inside. The door is equipped with a switch, which automatically stops the tumble dryer when the door is opened. The machine will not start automatically on closing the door (eg, if a child should close the door from the inside).



CHILD LOCK ON AND BUTTONS

By locking the  and  buttons, you can prevent that for example a child starts the machine or changes the settings by mistake.

Child lock On/Off

Turn the main power switch, , off and then turn it on again.



Press the  button five times, then press the  button five times. These ten times must be completed within fifteen seconds.

Within three seconds after the last press on the  button, use the   buttons to choose Child lock ON (the figure 3 will appear at the bottom right in the display) or OFF (the figure 0 will appear at the bottom right in the display).

To start a programme with locked button.

Press the  button for three seconds and the machine will start.

To change programme settings with Child locked button.

Press the  button for three seconds, after that the  button works normally again. If you do not press any button within two minutes, the  button will be locked again.

This page has been left blank for technical printing reasons.

4 PARTS OF THE TUMBLE DRYER

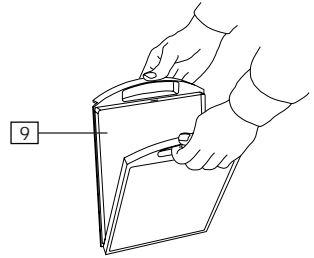
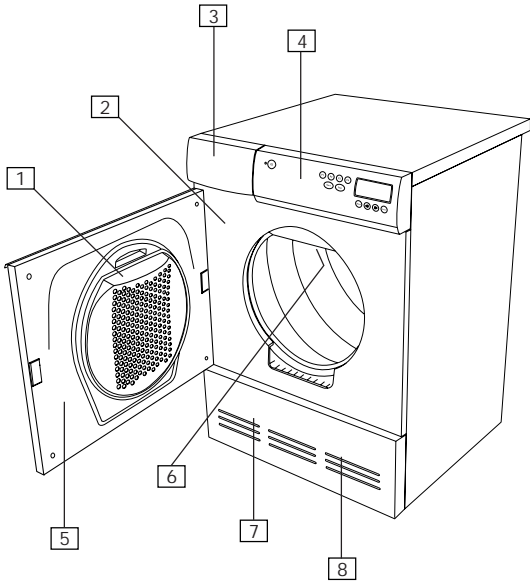

- 1. FLUFF-FILTER HOLDER

- 2. DATA PLATE

- 3. CONDENSATION WATER CONTAINER

- 4. PANEL

- 5. OUTER DOOR

- 6. INTERIOR LIGHTING (ON THE INSIDE)

- 7. FAN (BEHIND THE LOWER COVER)

- 8. CONDENSER (BEHIND THE LOWER COVER)

- 9. LINT FILTER

5 PANEL

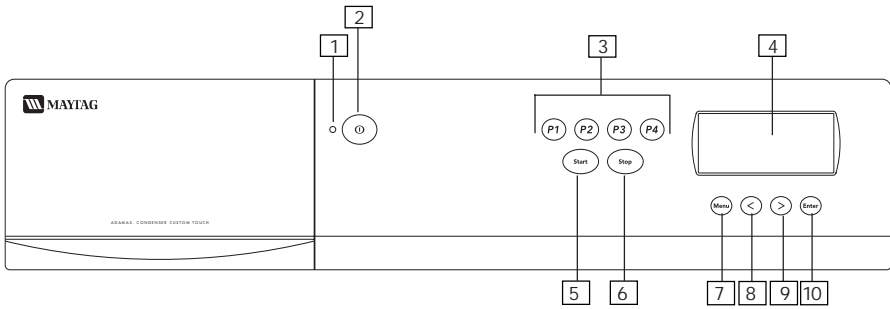

1. INDICATOR LAMP ON/OFF

2. MAIN POWER SWITCH

3. PROGRAMME SELECTOR BUTTONS P4-P4

4. DISPLAY

5. START BUTTON

6. STOP BUTTON

7. MENU BUTTON

8. INDEX BACK/REDUCE TIME

9. INDEX FORWARD/INCREASE TIME

10. ENTER BUTTON

6. LC-DISPLAY

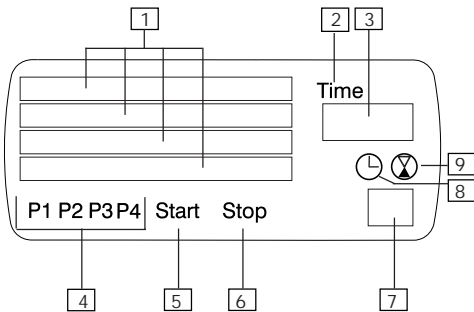

1. TEXT FIELD INDICATING PROGRAMME, OPTIONS AND FAULT MESSAGES, ETC.

2. INDICATES THAT [3] IS SHOWING THE SELECTED TIME FOR A TIMED DRY OR AN AIR FLUFF PROGRAMME

3. SHOWS THE SELECTED TIME FOR TIMED DRY PROGRAMMES

4. INDICATES THE SELECTED PROGRAMME

NOTE

The display will be extinguished if no buttons are pressed within three minutes. The display will be reinstated the next time any button is pressed.

5. INDICATES THAT A PROGRAMME HAS STARTED

6. INDICATES THAT A PROGRAMME HAS BEEN COMPLETED

7. SEE 8 AND 9 BELOW

8. INDICATES THAT DELAYED START IS ON. [7] THEN INDICATES HOURS REMAINING TO START

9. INDICATES THAT [7] IS DISPLAYING THE PROGRAMME TIME REMAINING IN HOURS AND MINUTES (ALTERNATING), INCLUDING THE COOLING TIME.

7 BEFORE TUMBLE DRYING

Before you start tumble drying, here is some advice that can be useful.

SPIN-DRIED?

Items that are to be tumble dried should first be spin-dried, preferably at 800 revs per minute or more. Better spin drying saves both energy and drying time.

RECOMMENDED WASHING MARKING



Material suitable for tumble drying

The symbol above indicates that the material can be tumble-dried. Cotton fabrics, towelling and synthetic fibres are best suited to tumble drying. Clothes and fabrics become softer and fluffier when tumble-dried than when dried on a line.

NOTE

Wear and tear of fabrics in a tumble dryer is minimal. The lint caught in the lint filter consists of dust and fibre residue that has been formed when wearing the garments.



Material which should not be tumble-dried

This symbol indicates that the material will not withstand tumble-drying.

Certain materials will melt or become dangerously flammable if heated, while others will lose their shape or shrink.

Do not tumble-dry...

- Materials that are marked "Do not dry close to heat".
- Items that have been dry-cleaned at home.
- Foam plastic.
- Glass-fibre materials
- Woollen items, because of the risk of felting.

SORTING FABRICS

Best results are obtained if all articles are of the same material.

Close zip-fasteners, button up garments, tie belts, and sort the fabrics and adapt the load and the temperature as shown in the table below.

TYPE OF FABRIC		LOAD	TEMPERATURE
White, coloured and synthetic	Cotton and linen	1/1 (6.0 kg)	Normal
	Polyester/cotton	1/2 (3.0 kg)	Normal
Delicate and mild	Acrylic, rayon, acetate etc.	1/2 (3.0 kg)	Low

Sort a suitable amount and type of fabric.





PROGRAMMES

Your choice of programme will depend on what you wish to do with the fabrics after tumble drying. The available programmes are Extra dry, Dry, Normal dry, Iron dry, Timed dry and Air fluff.

Extra dry

This programme is designed for washing that is extremely difficult to dry, eg, jeans with very thick seams.

NOTE

Knitted fabrics in particular are liable to shrink. Use the Dry, Normal dry or Iron dry programme for these materials. Always stretch garments out directly after drying.

Dry, Normal dry

These programmes turn off the heat when the washing is dry, but not bone-dry.

The Dry programme turns off the heat a little later than Normal dry. Choose what you prefer by trial and error. Use these programmes when you want dry fabrics.

Iron dry

This programme turns off the heat when the washing is just damp enough for ironing or mangling.

Timed dry

The programme length that you should choose depends on what you wish to do with the fabrics after tumble drying. Dry different times for different materials to find the right combination.

When using a timed dry programme with mixed washing it may happen that some of the items will not be sufficiently dried. Such items can suitably be dried by running the timed programme for a further 10 minutes or so.

Timed dry programmes automatically operate at temperature Low, but you can change it yourself to Normal.

NOTE

When using a timed programme it is possible to over-dry fabrics if you set too long a time. This can cause fabrics to shrink or crease and feel rough. Synthetic materials can also become charged with static electricity. Set a shorter time if you tumble dry at temperature Normal.

Air fluff

Use the air fluff programme just to shake dust out of garments, air them or soften them up.

To select Timed dry or Air fluff, see Chapter 10, Making own drying programmes.

OPTIONS

Cooling

You can choose between Normal cooling and Quick cooling. Normal cooling lasts 20 minutes and Quick cooling lasts 5 minutes.

Buzzer

The machine offers you the possibility of hearing when the cooling period ends. Set the option Buzzer ON and it will sound for three seconds when the programme is completed.

Anti-crease programme

Using the Anti-crease programme you can prevent garments from lying still and becoming unnecessarily creased at the end of tumble drying. This is a helpful option if you cannot take out garments promptly at the end of the tumbling phase.

You can choose a programme duration of 1, 2 or 3 hours. The drum will then continue to rotate intermittently, ie, three seconds every minute for the number of hours chosen.

If you choose Buzzer ON, a signal will sound each time the drum rotates.

To choose these options, see Chapter 10, Making own drying programmes.

TEMPERATURE

You can choose temperature Normal or Low, see chapter 10, Making own drying programmes.

DRYING TIME

The drying time may be influenced by a number of factors, such as the size of the load, the program selected, the moisture content of the load, the materials being washed, connection capacity and the ambient temperature and humidity. Drying time remaining is calculated within four minutes of the start of the drying program. The estimated time is shown in the bottom right-hand corner of the display, together with the – symbol.

If the actual drying time is less than that calculated, the time display may jump ahead, e.g. from 50 to 20 minutes, at the end of the program.

If the actual drying time is longer than that calculated, the countdown will stop at the end of the program until the load is dry.

Please note that times include a cooling period.

8 TUMBLE DRY



TUMBLE DRYING WITH EASY CONTROL

Easy tumble drying by pushing a few buttons

Your tumble dryer works like a radio with pre-set tuning. Instead of radio stations, however, you select your preferred drying programme in this case. We have preset the (P1) (P4) buttons with four common programmes.

Switch on the dryer and press the button for your preferred programme. You then simply press the Start button to start the programme.

To alter the settings for (P1) (P4)

You can create your own favourite programmes, if you wish. You can even preset Timed dry and Air fluff programmes.

You can also adapt settings and options such as temperature, buzzer, cooling and delayed start to suit your particular needs.

Chapter 10 - Making your own drying programmes, tells you what to do to create a temporary or permanent drying programme. It also includes a description of all the available programme types, options and other settings.

SORT FABRICS

SETTINGS OF THE FOUR PRE-SET PROGRAMMES.

PROGRAMME BUTTON	PROGRAMME	Cooling	Buzzer	Options	Anti-crease programme	TEMPERATURE	DELAYED START
P1	EXTRA DRY	NORMAL	ON	ON, 1 h	NORMAL	0 h	
P2	DRY	NORMAL	ON	ON, 1 h	NORMAL	0 h	
P3	NORMAL DRY	NORMAL	ON	ON, 1 h	NORMAL	0 h	
P4	IRON DRY	NORMAL	ON	ON, 1 h	NORMAL	0 h	

1 For tips and advice, see Chapter 8 – Before tumble drying.

NOTE

Empty the pockets. Coins, nails and similar items can cause damage to the dryer.

TURN ON THE MAIN POWER SWITCH (ⓘ)

2

OPEN THE DOOR, PUT IN THE WASHING AND CLOSE THE DOOR AGAIN

3

See Chapter 7 for the recommended quantity of washing – Before tumble drying.

4

SELECT A PROGRAMME [##]

The dryer has four pre-set programmes. Press the button for the desired programme. The programmes are shown in the table below.

Your choice of programme will depend on what you wish to do with the fabrics after tumble drying. See also Chapter 7 – Before tumble drying.

5 START TUMBLE DRYING

Press the  button. The text **Start** at the lower edge of the display indicates that the programme has started. The text field of the display shows the current stage of the programme while it is in progress.

NOTE

If the child lock is on, the  button must be held down for 3 seconds in order for the programme to start. See Chapter 3, Child safety, for details of how to switch the child lock on and off.

Remaining drying time

The approximate remaining drying time is estimated within four minutes of the start of the drying programme. Only the time for the **Ti-med dry** programme and **Air fluff** programme is indicated for venting dryers.

The time is shown in hours and minutes (alternating) at the bottom right of the display together with the  symbol. Note that the time also includes cooling.

DURING TUMBLE DRYING

Putting in more washing

Open the door and the drum will stop automatically. To restart: Close the door and press the  button.

Changing programme

Press the  button for three seconds. The programme will then be zero set and you can choose a new programme.

6 DRYING PROGRAMME ENDED

The text **STOP** on the bottom edge of the display indicates that the programme has ended.

If the **Anti-crease** option is activated, the drum will rotate every minute for a certain period after cooling. The text [**Anti-crease**] is indicated in the display during this period. The programme can be stopped at any time by opening the door.

When the programme ends:

- Clean the lint filter after each drying operation, see below. An error message will be displayed if the lint filter needs to be cleaned.
- Empty the condensation water container.

WARNING!



If the lint filter becomes completely clogged the overheat protection device may trigger. The device must then be reset to enable the machine to be started, see Chapter 12, Trouble shooting.

CLEANING THE LINT FILTER

1. Grasp the filter handle and pull towards you.
2. Pull the filter up out of the holder.

3. Open the filter and brush away the lint with your hand.

4. Fold the filter together and put it back in the filter holder.

The filter may require cleaning if lime scale deposits are present; see Chapter 10, Care and Cleaning.

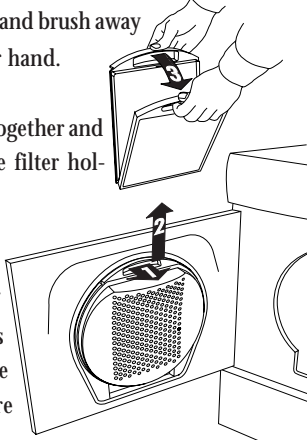

EMPTYING THE CONDENSATION WATER CONTAINER

Empty the condensation water container after each tumble drying.

Pull out the condensation water container, empty the water and put the container back.

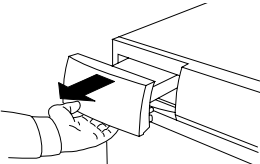

If the container becomes too full, the programme will be interrupted and an error message will be displayed in the text field. Empty the container and press the **Start** button and the programme will continue from where it was in-

terrupted, see also Chapter 12, Trouble shooting, heading Fault indications.

NOTE

Do not pull out the condensation water container while the machine is running.

HINT



The condensation water is soft, and is therefore suitable for use in a steam iron. Strain the water through a coffee paper filter before use.

If you want the water to be emptied automatically, see the Installation instructions.

7 AFTER TUMBLE DRYING

Turn off the main switch

AUTOMATIC DRAINING

See the Installation Instructions if you require the water to be drained automatically.

TEMPORARY PROGRAMME

If you wish to run a programme without altering the pre-set programmes **P1** - **P4**, you can create a temporary programme; see Chapter 10 - Making your own drying programmes.

DELAYED START (1-24 HOURS)

If Delayed start is set to 5 hours, for example, this means that the machine will start the programme 5 hours after you press the **Start** button.

If you wish to delay the start of any programme temporarily, you should proceed as follows before pressing the **Start** button:

1. Select the programme, but do not press the **Start** button.
2. Index forward with the **Menu** button until Delayed start appears in the display.
3. Index forward to the desired number of hours with **<** **>**.
4. Press the **Enter** button **once**. The selected programme appears in the display.
5. Press **Start** to start the programme.

Delayed start is disconnected automatically at the end of the programme.

9 CONSUMPTION VALUES - PRE-SET DRYING PROGRAMMES

The following conditions apply for the consumption values indicated below:

Temperature of intake air: 20 °C.

Humidity of intake air: 65 %.

Drying temperature: Normal (g*), Low (g*).

Element power: 2500 W.

The cotton fabrics are, before tumble drying, spin-dried at 800 and 1600 rpm (long spin) with MAYTAG washing machine.

Other fabrics (creasfree and acrylics) are, before tumble drying, spin-dried at 800 rpm (short spin) with MAYTAG washing machine.

PROGRAMME	WASHING	AMOUNT OF WASHING	ENERGY CONSUMPTION		PROGRAMME TIME	
			(ca kWh)		(ca minutes)	
			800 rpm	1600 rpm	800 rpm	1600 rpm
P1 Extra dry	Cotton, linen, g*	1/1 (6.0 kg)	4.5	3.7	115	95
P2 Dry	Cotton, linen, g*	1/1 (6.0 kg)	4.0	3.2	100	80
	Crease free, polyester/cotton, g*	1/2 (3.0kg)	1.8	---	45	---
P3 Normal dry	Cotton, linen, g*	1/1 (6.0 kg)	3.8	2.9	90	70
	Crease free, polyester/cotton, g*	1/2 (3.0kg)	1.6	---	450	--
	Acrylics, rayon, acetate, g*	1/2 (3.0 kg)	2.1	---	75	---
P4 Iron dry	Cotton, linen, g*	1/1 (6.0 kg)	3.0	2.0	80	505

10 MAKING OWN DRYING PROGRAMMES

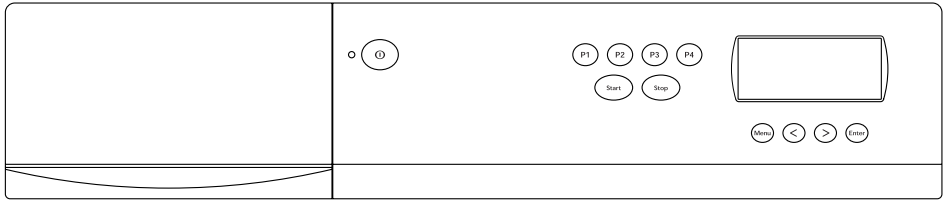

We have preset **P1** - **P4** with the most common drying programmes; see the table below. These programmes usually suit most users.

You can also create your own programmes to suit you and your washing needs even better.

You can select a different type of programme, for example a Timed dry programme and an Air fluff programme, or you can alter settings and options such as Buzzer, Temperature, Non-iron, Cooling or Delayed start.

This Chapter includes tables containing information about all programme types, settings and options.

Change programme

In this Chapter we tell you how to replace one or other of the pre-set programmes with a programme of your own.

By storing the programme, it will then be accessible simply by pressing a button every time you wish to use the tumble dryer.

Temporary programme

You can also make a temporary change of programmes, settings and options. The change is not stored in this case, but is deleted as soon as the programme is completed and the door is opened.



SETTINGS OF THE FOUR PRE-SET PROGRAMMES.

PROGRAMME BUTTON	PROGRAMME	OPTIONS			TEMPERATURE	DELAYED START
		Cooling	Buzzer	Anti-crease programme		
P1	EXTRA DRY	NORMAL	ON	ON, 1 h	NORMAL	0 h
P2	DRY	NORMAL	ON	ON, 1 h	NORMAL	0 h
P3	NORMAL DRY	NORMAL	ON	ON, 1 h	NORMAL	0 h
P4	IRON DRY	NORMAL	ON	ON, 1 h	NORMAL	0 h

AVAILABLE SETTINGS AND OPTIONS

Setting/Option	Description	Restrictions
Programme types	Available programmes are described in a separate table. Change of programme type resets all options and settings to their original values.	
Temperature, low/normal	Drying temperature.	All programmes without Air fluffing.
Delayed start (0-24 hours)	If you select a delayed start of five hours, for example, the machine will start five hours after you pressed the start button. The time remaining until the start is shown in the display. The change to this option is not stored permanently.	Can be used with all programmes.
Buzzer On/Off	With Buzzer On, a 3-second buzzer signal will be heard at the end of the programme.	Can be used with all programmes.
Crease-free 0-3 hours (0-180 min)	The drum will rotate for 3 seconds per minute for the indicated period after the end of the drying programme. With Buzzer On, a buzzer signal will be heard each time the drum rotates. Can be interrupted at any time by opening the door.	Can be used with all programmes.
Cooling, Normal/Short	Normal cooling continues for 20 minutes, and short cooling for 5 minutes..	All programmes without Air fluffing.

AVAILABLE PROGRAMME TYPES

Programme type	Description	
Extra dry	Programme that gives the driest fabrics.	
Dry	Shuts off the heat when the fabrics are dry, but without being snuff-dry. Dry shuts off a little later than Normal dry.	
Normal dry	Shuts off the heat when the fabrics are dry, but without being snuff-dry.	
Iron dry	Shuts off the heat when the fabrics are still slightly damp.	
Timed dry	You decide the duration of the programme by using an individual setting as described below. You can also change the duration with the   buttons on each occasion before you use the programme (before you press  .	
Air fluff	A programme without drying heat, under which you select the duration of the programme (see Timed dry programme).	

CREATE YOUR OWN DRYING PROGRAMME

1. Press one of the buttons **(P1)** - **(P4)** under which you wish to store your programme. You can select any button you like if you only want to make a temporary programme.

2. Index forward with the **(Menu)** button to the first setting or option that you wish to change. If the child lock is activated, nothing will happen. Hold down the button for 3 seconds, and then press as usual.

All the programme types, settings and options are described in the table alongside.

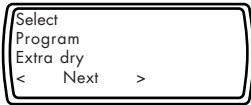

3. If you wish to change a setting, you should index forward or back with the **(<)** **(>)** buttons until the desired setting appears in the display.

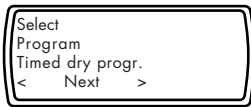

4. Then index further with the **(Menu)** button to the next setting/option, and change it in the same way if required.

5. Index further and make changes in the same way until the finished programme appears in the display together with any options. The text Stop will be displayed on the bottom line.

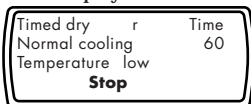

You can now use the programme without storing it (temporary programme). Press the **(Start)** button to start the programme.

Store the programme

If you wish to store the programme for use whenever you intend to use the tumble dryer, press the **(Enter)** button before starting. The button selected by you originally (P1-P4) will appear at the bottom left of the display.

You can now select the programme by pressing the button chosen by you in Step 1.

NOTE

The Delayed start option is not stored permanently.

IMPORTANT

If you store a programme by mistake, you can reset it to its settings at the time of delivery; see Reset programme later in this Chapter.

TIP

If you do not wish to index through all the settings, you can terminate the input by pressing the **(Enter)** button ONCE. To store the programme, you must then press the **(Enter)** button once more.

INTERRUPT INPUT

If you change your mind and wish to interrupt the input sequence, you should switch off the dryer with the main power switch **(⏻)**. When you switch it on again, you can start from the beginning or select one of the pre-set programmes as usual.





RESET PROGRAMME

If you wish to revert to the settings which a pre-set programme had at the time when the dryer was supplied, you can reset the programme. Proceed as follows:

1. Hold down the programme button (P1-P4) for the programme that you wish to reset.
2. Press the  button once.
3. Release the programme button.

The programme for the button concerned will now have reverted to its settings at the time when the dryer was supplied.

MENU SYSTEM FOR CHANGING A PRESET PROGRAM

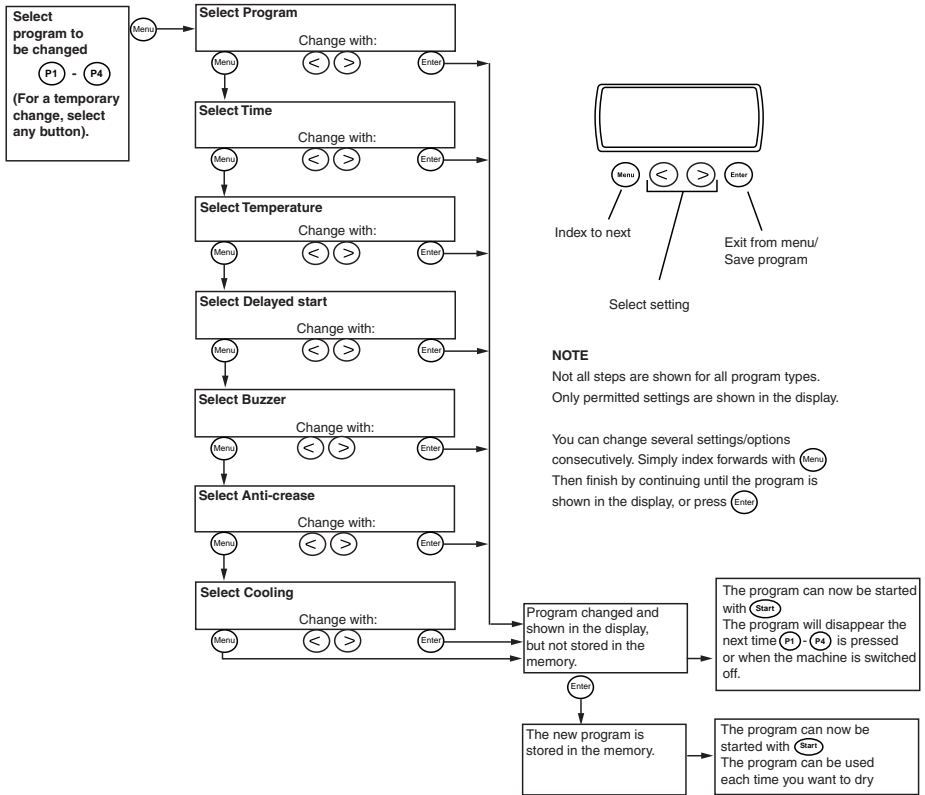

This page has been left blank for technical printing reasons.

11 CARE AND CLEANING

CLEANING THE LINT FILTER

Clean the lint filter after each tumble drying operation.

If your water is very hard a deposit of lime may be formed on the filter. Check when cleaning lint from the filter if there is any sign of lime, if so wash the lint filter by hand to remove any deposits.

1. Grasp the filter handle and pull towards you.

2. Pull the filter up out of the holder.

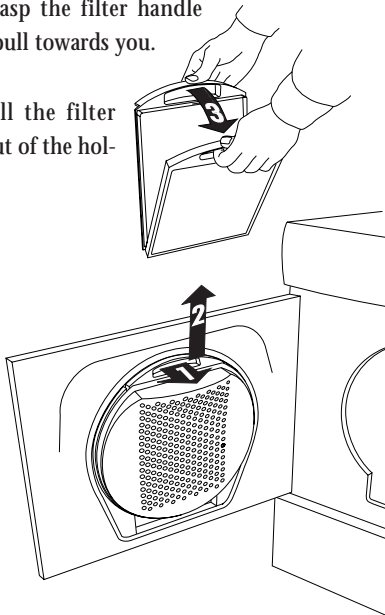

3. Open the filter and remove fluff from all sides of the filter by hand. Use a soft dry cloth to remove any remaining fluff.

4. Replace the filter in the filter holder.

If limescale develops on the filter, rinse it in water to remove the limescale.

Dry the filter thoroughly with a hand towel.

EMPTYING THE CONDENSATION WATER CONTAINER

Empty the condensation water container after each tumble drying.

Pull out the condensation water container, empty the water and put the container back.

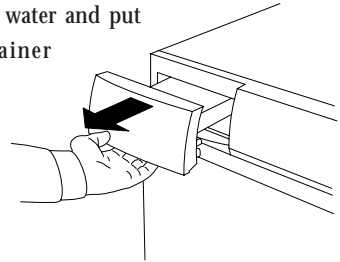

If the container becomes too full, the programme will be interrupted and an error message will be displayed in the text field. Empty the container and press the **Start** button and the programme will continue from where it was interrupted, see also Chapter 12, Trouble shooting, heading Error messages.

NOTE

Do not pull out the condensation water container while the machine is running.

CLEANING THE OUTSIDE OF THE MACHINE

Use a mild detergent to clean the outside of the machine. Do not use any solvents, they can damage the machine. Do not spray the machine with water.

NOTE

Do not allow dust to accumulate round the machine. Keep clean and cool around the tumble dryer. Dust, heat and moisture prolong the drying time.



CLEANING THE FAN

The fan should be cleaned at least once a year. If you have any household pets the fan must be cleaned more often.

1. Turn off the main power switch.

2. Remove the lower cover.

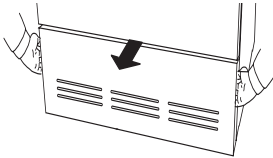

3. Remove the safety screw (1). Prise out the four clips in the order shown and remove the fan cover.

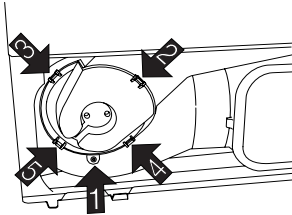

4. Unscrew the nut while holding the fan.

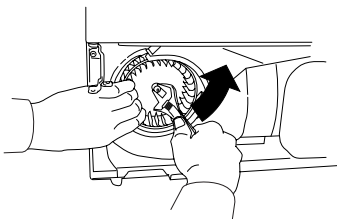

5. Take out the fan and clean it with a brush and water.

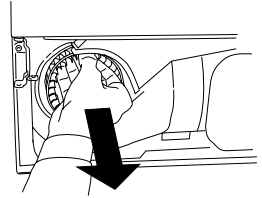

6. Put the fan back into place and screw on the nut.

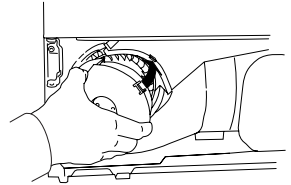

7. Refit the fan cover, making sure the clips hold the cover in place. Don't forget to fit the safety screw.

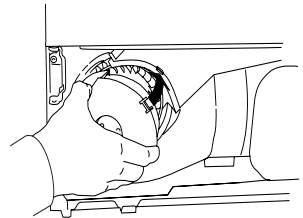

8. Fit the lower cover back in place.

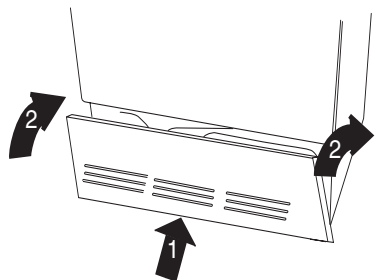

CLEANING THE CONDENSER

The condenser should be cleaned at least three times a year. . If you have any household pets the condenser must be cleaned more often.

1. Turn off the main power switch.
2. Remove the lower cover.

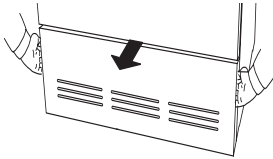

3. Turn the two levers anticlockwise to open the condenser cover.

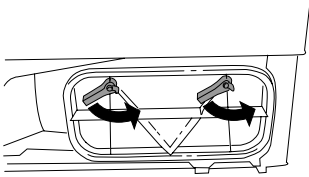

4. Take the condenser out and rinse the condenser fins clean, eg, using a hand-held shower. Do not poke anything between the fins, you might damage the condenser. Do not use any sharp object when cleaning the fins.

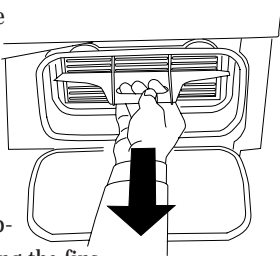

NOTE

Do not attempt to clean the condenser in a dishwasher.

5. Refit the condenser, taking care to fit it the right way up.

The top of the condenser is marked "upp", "up" and "oben".

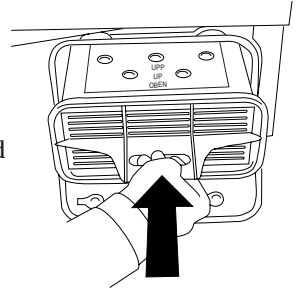

6. Fit the lower cover back in place.

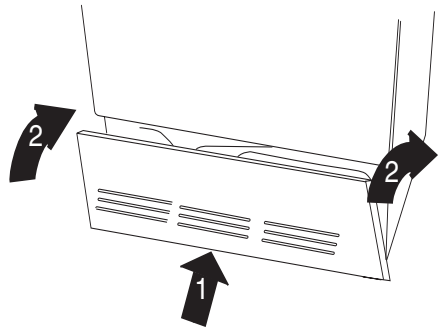

12 TROUBLE SHOOTING

THE MACHINE WILL NOT START

Check that:

- The door is properly closed.
- The main switch is pressed in.
- You have correctly set the required programme or the required time in the timed dry programme.
- You have not chosen Delayed start.
- The electric plug, if any, is firmly inserted in its socket.
- All fuses are intact. Switch two fuses over. It is not always possible to see directly if a fuse has blown.
- The overheating device has not triggered, see below.

OVERHEATING PROTECTION

The dryer is designed with an overheat protection switch that will automatically turn the machine off if the temperature gets too high. The machine will not start until it has cooled down sufficiently.

If the unit shuts down because of overheating, check that the lint filter exhaust hose, vent duct, and the condenser unit are free of lint. These components need to be cleaned on a regular basis. Additionally, the lint filter may need to be cleaned with warm, soapy water and a soft brush a few times a year to ensure the filter screen is not blocked. Using dryer sheets (not recommended) can also cause this problem.

Should the machine turn itself off because of overheating, it will not be possible to restart the unit until it has cooled down sufficiently. This could possibly take up to thirty minutes.

To restart the unit once it has cooled down, press the "Start" button.

NOTE:

If your dryer overheats frequently, it may not be vented properly or the room in which it is located may not have sufficient air circulation. Contact your installer to have these issues checked out.

NO INTERIOR LIGHTING

Check that:

- The main switch is pressed in.
- The electric plug, if any, is firmly inserted in its socket.
- All fuses are intact. Switch two fuses over. It is not always possible to see directly if a fuse has blown.
- The bulb is not burnt out. The lamp is located at the top of the dryer just inside the door. Screw off the plastic cover protecting the bulb and screw out the bulb and replace it if it is faulty.

EXCESSIVE DRYING TIME

Empty the water container and check that the lint filter and the condenser are not clogged, see Chapter 11, Care and Cleaning. Excessive drying times can also be caused by the machine being installed in a very confined space and by the air in the room (which cools the machine) becoming too warm. In this situation make sure that ventilation is improved, eg, by opening doors and/or windows.

FAULT INDICATIONS

Error messages appear in the display text field if faults occur while a programme is in progress. To exit the error messages after correcting the fault as described below, switch the machine off or change the programme.

The error messages that can be displayed are:

Maximum programme time. When the machine has run for its maximum time (three hours) it will stop. Ensure first that all fuses for the machine are intact. To exit the error message, switch the machine off or open the outer door. If this does not help, phone for service.

Over flow. Indicating that the condensation water container is overfilled. Empty the container and restart. If the message is repeated it may be because the lower water magazine is full, due to the pump or hoses being clogged or malfunctioning. If condensation water is pumped out direct to the drain, check to ensure there are no kinks or stoppage in the hose. If this does not help, phone for service.

Sensor fault. Fault in the moisture sensor. This error message can also appear if you should start the dryer when it contains dry items or when it is empty. To cancel the message, simply open the dryer door. If this does not work, phone for service.



Thermistor fault. Phone for service.

WRONG LANGUAGE ON THE DISPLAY

If the language on the display becomes altered for any reason, it can be restored to the initial language again.

The available languages are Eng (AUS), Svenska, Dansk, Norsk, Suomi, Francais, Nederlands, Italiano, Espanol, Russia, Deutsch, Eng (US).

Proceed as follows to change the language:

Turn the main power switch, , off and then turn it on again. Press the  button five times, then press the  button five times. These ten times must be completed within fifteen seconds.

Within three seconds after pressing  the last time, step to the desired language using the





< > buttons.

RESET PROGRAMME

If you wish to revert to the settings which a pre-set programme had at the time when the dryer was supplied, you can reset the programme.

Proceed as follows:

1. Hold down the programme button for the programme that you wish to reset.
2. Press the **Enter** button once.
3. Release the programme button.

The programme for the button is now reset to its settings when the dryer was supplied.

STOP FLASHES IN THE DISPLAY

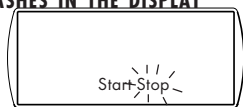

The programme has stopped temporarily because the door has been opened, the main power switch has been turned off or the power supply has been interrupted.

To restart: Press the **Start** button.

To interrupt the programme completely: Press the **Stop** button for three seconds.

13 TECHNICAL INFORMATION

TECHNICAL DATA

Height:	850 mm
Width:	595 mm
Depth:	585 mm
Weight:	47 kg
Drum volume:	111 litre
Max drying capacity:	6.0 kg
Speed:	52 r/min
Rated power:	See data plate
Material: Cylinder and water container	Stainless steel
Material: Outer cover	Hot-galvanized, powder-lacquered steel or stainless steel
Positioning:	Washing tower or free-standing
Drain	2.0 polypropylene hose
Interior light:	10 W, plint E14.

STANDARD TESTS

Europe:	EN 61 121 (95/ 13/ EEC).
Drying performance:	Programme 3, (Normal dry), 6.0 kg, cotton, temperature Normal.
Energy declaration:	EN 61 121 (95/ 13/ EEC). Programme 3, (Normal dry), 6.0 kg, cotton, temperature Normal.
Procedure for acoustic measurement:	IEC 704-2-6.

14 SERVICE AND GUARANTEE

SERVICE

Before calling for service, check to see whether the faults is due to something that you can put right yourself. See chapter 12, Trouble shooting.

If you do require service, telephone your local MAYTAG retailer or the MAYTAG representative for your country. See guarantee card for address and telephone number.

GUARANTEE

For guarantee details, see the guarantee card.

BEFORE CONTACTING THE SERVICE DEPARTMENT

Before contacting the Service Department, make a note of the model designation, type designation and serial number.

The model designation is on the panel. The type designation and the serial number are on the type plate located inside the door.

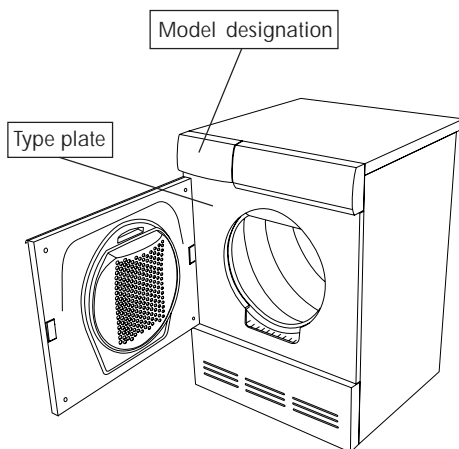
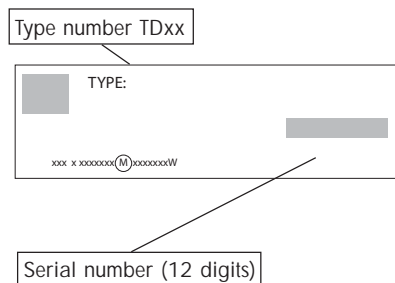

16 INDEX

	Chapter		Chapter		Chapter
A		F		Parts of the tumble dryer	4
Acetate	7,15	Fault indications	12	Polyester	7,15
Acrylate	7,8,15	Felting	7	Power consumption	9
After tumble drying	8,15	Flammable material	2,7	Pre-set drying programme	8, 15
Air fluff programme	7, 8, 10	Foamed plastic	7	Programme position	8
Altering settings	10			Programmes	7,8,10,15
Anti-crease programme	7,8,10	G		Q	
		Glass-fibre material	7	Quick guide	15
B		Guarantee	14		
Before tumble drying the first time	1	I		R	
Before tumble drying	7	Installation, see Instructions for installation		Rayon	7,15
Belts	7	Interrupt programme	2, 8	Recommended washing marking	7
		Iron dry	7,8,10,15	Remaining drying time	7
C		Ironing	7	Reset pre-set programme	10,12
Change programme after starting	8	J		Restarting	8
Children's safety	3	Jeans	7	S	
Child safety start	3	K		Safety	2
Cold ironing	7	Knitted fabrics	7	Service	14
Coloured washing	7	L		Signal	7,10
Condensation water container	8,11,12	Language	12	Sorting textiles	7
Condenser	11,12	LC Display	8	Spin-dried	7
Cooling	7,8,10	Linen	7,15	Start	8,15
Cotton	7,15	Lint filter	8,11	Synthetic fabrics	7
Crease-free, see Anti-crease programme		Low temperature	7,8,10	T	
D		M		Technical data	13
Delayed start	10	Making own drying programmes	10	Temperature	7,8,10
Delicate washing	7			Temporary programme	10
Display, see LC Display		N		Textile wear	7
Disposal	2	Normal dry	7,8,10,15	Timed dry programme	7, 8, 10
Do not tumble dry	7	Normal temperature	7,8,10	Tumble dry	8,15
Dry	7,8,10,15	O		W	
Dry cleaning	2,7	Options	7,10	Wool	7
Drying time	7	Overheating protection	2,12	Z	
E		Own programmes	10	Zip fastener	7
Emergency stop, see Interrupting the programme		P			
Error indications, see Fault indications		Packing material	2		
Extra dry	7,8,10,15	Panel	5		

15 QUICK GUIDE

1. Sort the fabrics.

2. Turn on the main switch .

3. Open the door, load the fabrics and close the door again.

Close the door carefully, and avoid slamming it.

4. Select a programme.

The dryer has four pre-set programmes; see the table. Press the button for the desired programme.

5. Press the  **button.**

6. Drying programme completed.

Open the door and take out the tumble-dried fabrics. The lint filter must be cleaned and the condensation water tank must be emptied after each tumble drying operation.

7. When tumble drying is completed.

Turn off the main power switch .

For details of how to use the Timed dry and Air fluff programmes, see Chapter 10, Making your own drying programmes.

WASHING →	Washing programmes		
	Cotton, linen etc	Polyester/cotton	Acrylics, rayon, acetates, (temperature sensitive materials)
Load (kg)	6.0	3.0	3.0
SET THE: Programme	P1 to P4 Extra dry, Dry Normal dry, Iron dry	P2 or P3 Dry or Normal dry	P2 or P3 Dry or Normal dry
Temperature	Normal	Normal	Low

Free Manuals Download Website

<http://myh66.com>

<http://usermanuals.us>

<http://www.somanuals.com>

<http://www.4manuals.cc>

<http://www.manual-lib.com>

<http://www.404manual.com>

<http://www.luxmanual.com>

<http://aubethermostatmanual.com>

Golf course search by state

<http://golfingnear.com>

Email search by domain

<http://emailbydomain.com>

Auto manuals search

<http://auto.somanuals.com>

TV manuals search

<http://tv.somanuals.com>