

USER'S GUIDE



Installer: Please leave this manual with this appliance.

Consumer: Please read and keep this manual for future reference. Keep sales receipt and/or cancelled check as proof of purchase.

Model Number

Serial Number













Date of Purchase

In our continuing effort to improve the quality and performance of our appliances, it may be necessary to make changes to the appliance without revising this guide.

If you have questions, call:

1-800-688-9900 (USA)
 1-800-688-2002 (CANADA)
 1-800-688-2080 (U.S. TTY for hearing or speech impaired)
 (Mon.-Fri., 8 am-8 pm Eastern Time)
 Internet: <http://www.maytag.com>

For service information, see page 11.

-  SAFETY INSTRUCTIONSPage 1
-  LOADINGPages 2-3
-  PORTABLE DISHWASHERPage 4
-  DISHWASHING ESSENTIALSPage 5
-  CONTROLS AT A GLANCEPages 6-7
-  OPERATING TIPSPage 7
-  SPECIAL CARE ITEMSPage 8
-  CARE AND CLEANINGPage 8
-  BEFORE YOU CALLPages 9-10
-  WARRANTYPage 11
-  GUIDE DE L'UTILISATEURPage 12
-  GUÍA DEL USUARIOPage 24

IMPORTANT SAFETY INSTRUCTIONS

WARNING:

Check with the installer to make sure the appliance has been properly grounded to avoid possible electrical shock. Be sure you read the Important Personal Safety Instructions before you use this dishwasher.

Products with a  label have been listed with Underwriter's Laboratories, Inc. – those with a CSA tag have been listed with Canadian Standards Association. Nevertheless, as with any other equipment using electricity and moving parts, there is a potential hazard.

WARNING:

When using your dishwasher, follow basic precautions, including the following:

1. Read all instructions before using the dishwasher.
2. Use the dishwasher only for its intended function.
3. Disconnect electrical power to dishwasher before attempting to service.
4. To avoid electrical shock hazard, the sides and back must be enclosed and the front panels must be attached before electrical power is applied to the dishwasher. Refer to the installation instructions for proper grounding procedures.
5. Connect to a properly rated, protected and sized power supply circuit to avoid electrical overload.
6. Children should never be permitted to operate, or play in, with, or around this dishwasher.
7. To reduce the risk of injury when loading items to be washed, sharp or pointed items should be located with the handles up. Also, load sharp items so they are not likely to damage the door seal.
8. Do not touch the heating element on the bottom of the tub during or at the completion of a cycle. It will be hot.
9. Use only detergents and rinse additives designed for an automatic dishwasher. Never use soap, laundry detergent, or hand washing detergent in your dishwasher. Keep these products out of reach of children.
10. Do not sit, stand on or abuse the door or dish racks of the dishwasher.
11. Under certain conditions, hydrogen gas may be produced in a hot water system that has not been used for two weeks or more. **Hydrogen gas is explosive.** If the hot water system has not been used for such a period, turn on all hot water faucets and let the water flow from each for several minutes. This will release any accumulated hydrogen gas. As the gas is flammable, do not smoke or use an open flame during this process.
12. Do not wash plastic items unless marked "dishwasher safe" or the equivalent. For plastic items not so marked, check the manufacturer's recommendations.
13. Do not tamper with controls.
14. To prevent accidental child entrapment and suffocation risks, always remove the door to the washing compartment when removing an old dishwasher from service or discarding it.
15. Use caution when unloading the dishwasher. Dishes will be hot if unloaded shortly after a cycle has completed.

Save These Instructions for Future Reference

LOADING

BEFORE YOU START

- Don't prerinse. Simply scrape off any bones or large food particles.
- If connected to a food waste disposer, **make certain the disposer is empty before starting the dishwasher.**
- **Scrape off tomato-based food soils** (see page 8).
- **Remove certain foods** (such as mustard, mayonnaise, lemon juice, vinegar, salt or dressings) **from stainless steel flatware as soon as possible.** These foods may cause rusting and pitting if allowed to remain in contact with the surface for an extended period of time.

GENERAL RECOMMENDATIONS

- **Place all items in the racks so they are separated and facing center.**
- Items can be centered behind a single tine or loaded at an angle to maximize space.
- Load items so they do not rest over the top of the wash tower.
- Avoid blocking the upper and lower spray arms by not allowing items to extend beyond the racks.

RECOMMENDED LOADING

(Rack features vary by model)

For best dishwashing results follow the guidelines below to determine the best arrangement for your items.

UPPER RACK

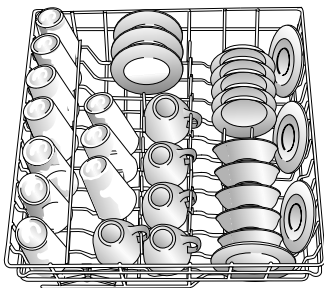

10 Place Settings

Glasses, cups, stemware, light-weight plastics, small plates, bowls, pans, long-handled utensils etc. can be loaded in this rack. **Do not load glasses over the tines.**

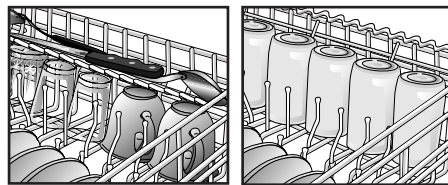

The **Stack-Rack** (select models) on the right side of the upper rack folds up or down for loading flexibility. Fold it down to hold long-handled knives, spatulas and spoons or short items like cups or juice glasses. Fold it up for taller items like glasses, bowls, plates, etc.

The **Vari-Lock™ Snugger** (select models) on the left secures lightweight items in place. It can be adjusted by grasping the wavy wire and rotating it left to snug items

against the outer rack or to the right to rest on top of light items. **Do not load items on top of the wire.**

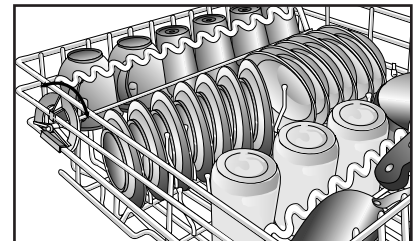

The wavy wire on the **Vari-Lock™ Snugger** (select models) and the **Stack-Rack** (select models) is designed to hold stemware in place. Taller stemware will fit better on the right side as the upper rack is deeper on this side.

ADJUSTABLE UPPER RACK (Select models)

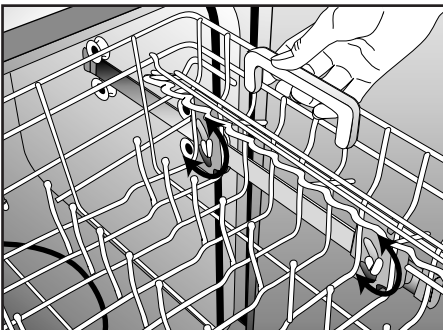

The **Adjustable Upper Rack** can be raised to accommodate taller plates, platters, pans, etc. loaded in the lower rack.

To raise the rack:

- Pull the rack fully out.
- Grasp the handle on the rear right side of the rack.
- Lift and pull the rack slightly forward to lock up into place.

To lower the rack:

- Pull the rack fully out.
- Grasp the handle on the rear right side of the rack.
- Lift and push the rack slightly back to lock back down into place.

NOTE:

- Face soiled surfaces towards the center of the dishwasher.

LOADING (CONTINUED)

LOWER RACK

3 saucers are loaded on the rack under the Stack-Rack Shelf (select models)

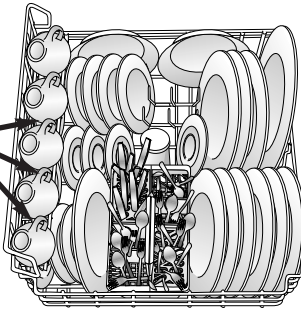

10 Place Settings

A variety of large items such as dinner plates, mixing bowls, pots and pans and baking dishes can be loaded in this rack.

Tall items such as bakeware and large platters can be placed on the left side or across the back of this rack.

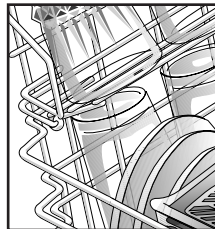
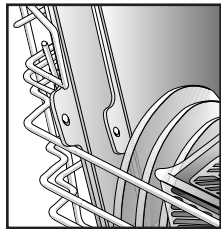
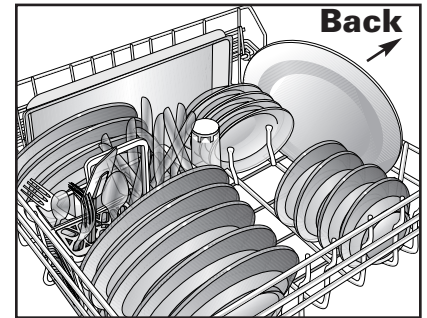

With the **Stack-Rack** (select models) shelf raised, thin items like cookie sheets or pizza pans may be placed along the left side. With the shelf down, two levels of glasses and cups can be loaded.

Positioning the **Fold-Away™ Tines** (select models) flat in the back, left corner provides convenient loading space for large, bulky items like pots and pans or mixing bowls.

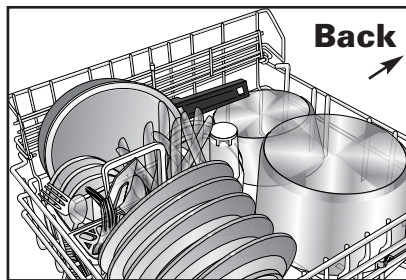

Convertible Tines (select models) in the back, right corner can be adjusted to provide narrow spacing for loading plates or wide spacing for loading deep bowls, pots or pans. Flip tines up for narrow spacing or down for wider spacing.

NOTE:

- Avoid resting items over the center wash tower.

REMOVABLE UTENSIL BASKET (Design varies by model)

For best cleaning results, prevent items from nesting together by placing some items in the basket with handles up and some with handles down. Load knives, handles up, through the slots in the hinged covered section(s) (when closed).

Be sure that thin, finely pointed items do not extend through the basket. This could block the lower wash arm.



Small, lightweight items like baby spoons and plastic measuring spoons should be placed in the section(s) with the hinged cover(s).

rack for loading miscellaneous items and utensils. This is also a safe place to load sharp knives and pointed items.

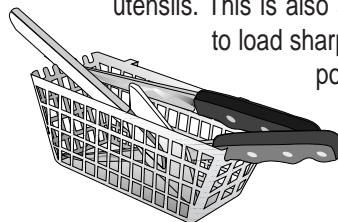

SPLIT & FIT UTENSIL BASKET (Select models)

The split silverware basket can be separated and placed in several locations in the bottom rack. Hold the basket firmly along the sides. Follow the unlock direction arrows imprinted on the basket and slide the basket apart until it splits into two. Load flatware and utensils into both sections or just one, depending upon your load.

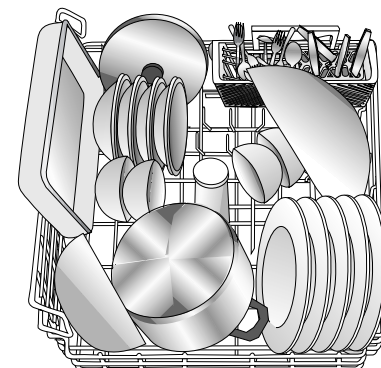
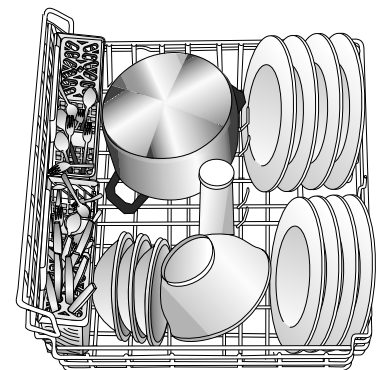
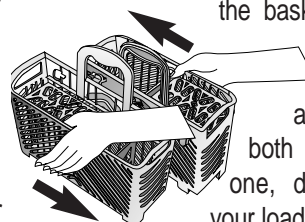

ODDS & ENDS BASKET (Select models)

Use this supplemental basket in the upper

REMOVING THE UPPER RACK

The upper rack can be removed when tall or oversized items need to be loaded into the lower rack.

TO REMOVE:

- Roll the upper rack 1/3 to 1/2 of the way out.
- Remove the plastic rack stop from the end of each track. To remove each

plastic rack stop, push inward (towards the rack) on the ridged area of the rack stop. The rack stop will snap open and can be easily removed by pulling straight out. Take care to support the track while removing rack stops.

- Roll the rack all the way out of the track and remove from the dishwasher.
- Reverse the above procedure to replace the upper rack into the dishwasher.

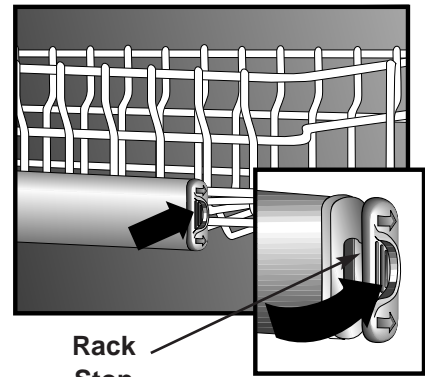

PORTABLE DISHWASHER

CONNECTING A PORTABLE

1. Turn on the faucet at the sink until the water runs hot. Turn off the faucet.
2. Pull the connector from the recess in the back of the dishwasher.
3. Press down on the thumb release and lift the connector onto the faucet.
4. Remove pressure from the thumb release and tug slightly on the connector to be sure it is securely in place.
5. Turn the hot water on full force.
6. Check that the sink drain is open so water from the dishwasher can drain properly.
7. Pull the electrical cord from the recess. Plug it into a properly grounded outlet.
8. Select the proper cycle and options for the load and start the dishwasher.
3. Push the connector and hoses back into the cabinet recess.
4. Unplug the electrical cord and push it back into the cabinet recess.

DISCONNECTING A PORTABLE

1. Be sure to turn the water supply off and press the pressure release button **BEFORE** removing the connector.
2. Press down on the thumb release and remove the connector from the faucet.

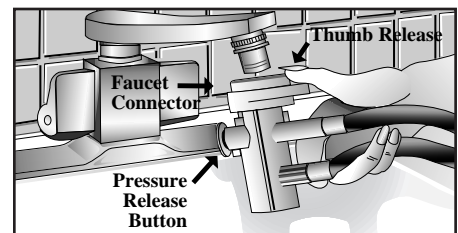

DISHWASHING ESSENTIALS

HOT WATER

For optimal cleaning and drying results, hot water is necessary. The incoming water temperature should be 120-140° F (49-60° C) to properly activate the detergent and melt greasy food soils.

To check the incoming water temperature, turn on the hot water faucet nearest the dishwasher and let it run into a glass in the sink. Place a candy thermometer in the glass and check the temperature once it has stopped rising. If the temperature is below 120° F (49° C), have a qualified person raise the water heater thermostat setting.

Before starting the dishwasher, turn on the hot water faucet and let it run until the water is hot. This assures that the initial fill of water is hot.

DETERGENT

Use a detergent designed specifically for use in an automatic dishwasher. Be sure it is fresh and stored in a cool, dry place (not under the sink).

RECOMMENDED AMOUNT

Too little detergent results in poor cleaning, hard water filming/spotting and poor dry-

ing. Too much detergent can cause permanent etching/cloudiness.

The amount of detergent to use is determined by the hardness of the water and soil level of the load. Refer to the following chart for detergent usage recommendations.

Do not use detergent with **Rinse Only**. Leave the detergent lid open when running **Rinse Only**.

In extremely hard water conditions (13 grains per gallon or more*), it is difficult to achieve good results with any dishwasher. A mechanical water softener may be necessary to improve water quality, detergent effectiveness, and protect the dishwasher parts from the damage that hard water can cause.

Water Hardness*	Soil Level	Detergent Amount** (per cup dosage)
Soft (0-4 gpg)	Light Soil	5 teaspoons
	Normal Soil	6 teaspoons
	Heavy Soil	8 teaspoons
Medium (5-9 gpg)	Light Soil	7 teaspoons
	Normal Soil	8 teaspoons
	Heavy Soil	10 teaspoons
Hard (10-12 gpg)	Light Soil	9 teaspoons
	Normal Soil	10 teaspoons
	Heavy Soil	12 teaspoons

*Your local water utility or state university extension service can tell you the degree of water hardness in your area.

** Add recommended amount of detergent to both compartments for AutoClean, Heavy or Normal wash cycles, and to the main cup only for the Light wash cycle.

RINSE AID

Regular use of a rinse aid improves drying, reduces spotting and filming, and reduces moisture left on the dishwasher interior.

Your dishwasher features an automatic rinse aid dispenser located near the detergent cups in the door.

The clear window in the center of the dispenser cap allows you to see if there is rinse aid in the reservoir. When the window is colored, there is rinse aid in the dispenser. When the window becomes clear, it is time to refill the dispenser. Check the dispenser monthly.

To add rinse aid to the dispenser, turn the cap counterclockwise to open. Remove the cap and pour liquid rinse aid into the

opening. Replace the cap and turn it clockwise.

Use the LESS setting for soft water and the MORE setting for hard water. Set the cap anywhere between these amounts as needed.

CONTROLS AT A GLANCE

CYCLES AND WATER USAGE

AUTO CLEAN (Select models)

Manufacturer's recommended cycle choice for all day-to-day soil types.

Normal dishloads vary from day to day. **Auto Clean** is recommended because it selects the number of fills and wash time best suited for the soil level of each load. Depending on the number of fills required water usage ranges from 4 to 10 gallons.

HEAVY WASH

Long cycle for heavy food soils. 10 gallons.

NORMAL WASH

Medium cycle for average food soils. Depending on the number of fills, water usage ranges from 4 to 8 gallons.

LIGHT WASH

Short cycle for light food soils. Depending on the number of fills, water usage ranges from 4 to 6 gallons.

RINSE ONLY

Rinses dishes being held until there is a full load. Controls odors. 2 gallons.

NOTE:

- Cycle times shown in the numerical display (select models) increase or decrease, based on each load's soil level, water temperature and selected options.

OPTIONS

TOUGH SCRUB™ or TOUGH SCRUB™ PLUS (Select models)

Select **Tough Scrub™** or **Tough Scrub™ Plus** when washing loads with hard-to-remove food soils. **Tough Scrub™** or **Tough Scrub™ Plus** can be selected with any cycle (except **Rinse Only**). Depending on which cycle is being used, selecting this option adds fills, heat and/or wash time to the wash cycle.

For baked-on, dried-on soils, select **Heavy Wash** along with the **Tough Scrub™** or **Tough Scrub™ Plus** option.

ACCUTEMP (Select models)

AccuTemp™ provides a water temperature check in the main wash and also in the

final rinse cycle. If necessary, the heating element will turn on and the cycle will be extended to heat water to the proper temperature.

Select **AccuTemp™** with any cycle (except **Rinse Only**) to assure proper hot water temperature and to enhance drying results.

SANITIZE (Select models)

Select **Sanitize** with **Auto Clean (select models)**, **Heavy**, **Normal**, or **Light Wash** to sanitize dishware. At the end of the cycle, when the cycle monitor recognizes that the proper conditions have been met, the **SANITIZED** light illuminates.

EXTRA RINSE (Select models)

Select **Extra Rinse** to add a rinse to the cycle. An extra rinse helps to improve

results in hard water situations. The extra rinse is already built into the cycle when **Heavy Wash** is selected.

HEATED DRY

Select **Heated Dry** to turn on the heating element during dry for enhanced drying results. When **Heated Dry** is not selected, towel drying of some items such as plastic and teflon may be necessary and more moisture may be noticed adhering to the dishwasher interior. With either dry option, it is normal to notice vapor escaping from the door vent.

DRAIN/OFF

To drain the dishwasher and then turn it off, press **Drain/Off** once. Press **Drain/Off** twice to turn the dishwasher off without draining.

INDICATOR LIGHTS

The **SANITIZED** (select models) light illuminates at the end of the cycle when conditions have been met to achieve sanitization.

NOTE:

- When **Sanitize** is selected, cycles are monitored to assure sanitization. Unusually low water temperature will prevent the sanitization protocol from being satisfied and the **SANITIZED** light will not illuminate at the end of the cycle.

The **CLEAN** light illuminates at the end of the cycle and remains lit until the door has been open for 30 seconds continuously.

The **DRY** light illuminates during the entire dry period and goes out when the cycle is completed.

The **WASH** light illuminates during all rinse and wash portions of the cycle.

The **HEATING DELAY** light illuminates when the cycle is being extended to heat the water.

The **CLEAN** and **SANITIZED** (select models) indicator lights will not reilluminate after a power failure until after the next cycle is run.

CONTROLS AT A GLANCE (CONTINUED)

DELAY/RESUME

The **Delay/Resume** option can be used to automatically start the cycle at a later time, such as during off-peak hours for reduced energy cost or to reduce daytime heat buildup in the home.

TO SET UP A DELAY:

1. Select the appropriate cycle and options for the load.
2. Press the **Delay/Resume** pad until the desired amount of delay time (1 to 9 hours) is selected. The delay time will begin counting down when the pad is released.
3. The **Delay/Resume** indicator light will remain lit until the delay time has counted down.
4. The cycle will automatically start as soon as the delay time expires.

NOTE:

- If **Delay/Resume** is chosen without selecting a cycle and/or options, the dishwasher will select the last cycle used. (It will not remember the **Rinse Only** cycle.)

TO CANCEL A DELAY:

Wait at least 2 seconds, then press the **Delay/Resume** pad again. The indicator light will go out and the cycle will start or resume immediately.

CONTROL LOCK OPTION

The control touchpads can be locked to prevent unwanted use. If this feature is activated between cycles, the dishwasher cannot be operated until the controls are unlocked. If desired, the controls can be locked after a cycle or delay has started.

NOTE:

- This option does not lock the door, only the dishwasher controls.

SETTING THE CONTROL LOCK:

1. Press the  pad for three seconds.
2. An indicator light above the pad will illuminate when the controls are locked.

TO CANCEL:

1. Press the  pad for three seconds.
2. The indicator light will go off.

NOTE:

- If a cycle or option pad is pressed after the controls have been locked, the indicator light above the **Control Lock** pad will flash five times.

OPERATING TIPS

STARTING THE DISHWASHER

1. After loading the dishwasher and adding detergent, close the dishwasher by pressing the door until the latch clicks.
2. To start the dishwasher, firmly press the desired cycle and options pads. After a pause, the fill will begin. To prevent unplanned cycle or option changes, these selections are "locked in" after 1 minute.
3. The indicator lights for the selected cycle and options will glow.
4. To cancel an option, press the pad again. To cancel a cycle, press the **Drain/Off** pad.

NOTE:

- Extended interruption of the wash cycle is not recommended.

ADDING A FORGOTTEN ITEM

For best cleaning, the forgotten item should be added early in the cycle.

1. Press the **Delay/Resume** pad or unlatch the door.
2. Wait for the water circulation to stop.
3. Open the door and add the item.

4. Close and latch the door.
 - If **Delay/Resume** was pushed, push it again to restart the dishwasher.
5. After five seconds, the cycle resumes automatically at the point of interruption.

NOTE:

- If a cycle or option pad is pressed after the controls have been "locked in", the indicator light above the **Control Lock** pad will flash five times.

SPECIAL CARE ITEMS

Most tableware, cookware and flatware can safely be washed in your dishwasher. If you have any doubts about an item, check with the manufacturer.

Material	Dishwasher Safe?	Special Information
Aluminum	Yes, except anodized.	High water temperature and detergents may affect finish.
Cast Iron	No	Seasoning will be removed, and iron will rust.
China/ Stoneware	No, if antique or hand-painted.	Always check manufacturer's recommendation before washing. Antique, hand-painted or over-the-glaze patterns may fade. Gold leaf may discolor.
Crystal	No, if antique or delicate crystal.	Always check manufacturer's recommendation before washing. Some types of leaded crystal may etch with repeated washings.
Furnace Filters	Not recommended.	May leave a dingy deposit or stain on dishwasher interior.
Glass	Yes	Milkglass can yellow with repeated dishwasher washing.
Gold-Plated Flatware	No	Will discolor.
Pewter, Tin	No	
Plastics	Yes, top rack.	Always check manufacturer's recommendation before washing. Plastics vary in their capacity to withstand high water temperatures and detergents. Disposable plastic items are not dishwasher safe for this reason.
Stainless Steel	Yes	Run a Rinse Only cycle if not washing immediately. Prolonged contact with foods containing salt, vinegar, milk products or juice could damage finish.
Sterling Silver or Silverplate	No, if has commercial "darkening".	Always check manufacturer's recommendation before washing. Run a Rinse Only cycle if not washing immediately. Prolonged contact with food containing salt, acid or sulfide (eggs, mayonnaise and seafood) could damage finish. Commercial "darkening" may be removed by detergent.
Wooden Items	No	Wood may warp, crack or discolor.

CARE AND CLEANING

INTERIOR

The dishwasher interior is normally self-cleaning. Periodically check the bottom of the dishwasher tub to see if any large particles have not gone through the strainer portion of the module.

Wipe the edge of the inner door liner to remove any food soil splashes which occurred during loading.

The color from some tomato-based food soils has been known to occasionally adhere to today's dishwasher tubs, causing temporary discoloration.

When washing a load of dishes soiled with tomato sauce:

- Scrape excess tomato-based food soils off of dishes, prior to loading. Do not prewash the dishes, however.
- Run the **Heavy Wash** cycle.

EXTERIOR

The front of the dishwasher can be cleaned with a soft damp cloth and liquid spray cleaner. Do not use abrasive powders or cleaning pads.

Stainless Steel Care and Cleaning (select models)

- **Do not** use a cleaning product containing chlorine bleach.
- **Always** wipe **with** the grain of the stainless steel.

For daily cleaning and light soil, use a soft cloth or sponge and one of the following: Mild detergent and water, a solution of white vinegar and water, Formula 409 Glass and Surface Cleaner* or a similar multi-surface cleaner. Rinse and dry. To polish and to help prevent fingerprints, follow with Stainless Steel Magic Spray* (part No. 20000008)**.

For moderate to heavy soil, clean with Bon Ami*, using a soft cloth or damp sponge. Rinse and dry. To restore luster and to remove streaks, follow with Stainless Steel Magic Spray*.

For discoloration, wipe with Cameo Stainless Steel Cleaner*, using a damp sponge or soft cloth. Rinse immediately and dry. To restore luster and to remove streaks, follow with Stainless Steel Magic Spray*.

STORAGE/MOVING

Fill both detergent cups with a fresh-scented dishwasher detergent or baking soda and select the **Normal Wash** cycle. Allow the dishwasher to complete the cycle. Then turn the water supply off and drain the dishwasher. To drain, press the **Drain/Off** pad once. Operate the drain twice to ensure most of the water is removed. Last, disconnect the electrical supply and prop open the door. (See Important Safety Instructions, #14, page 1).

BEFORE YOU CALL

CHECK THESE POINTS TO HELP SAVE YOU TIME AND MONEY.

Dishwasher Will Not Fill:

- Be sure door is latched securely.
- Be sure the water is turned on.
- Check that the pad is properly selected for a cycle.
- Allow time to pause before filling.
- Check your home's circuit breaker or fuse box.
- Check inlet hose for a kink.
- Check water valve inlet for sediment and clean if necessary.

Dishwasher Will Not Drain/Water In Tub Bottom:

- If hooked up to a food waste disposer, be sure the knock-out is removed from the disposer inlet.
- Be sure the drain hose is elevated at least 32" so water cannot siphon back into the tub.
- Check for food obstruction in the drain or disposer.
- Check drain hose for a kink.
- Check your home's circuit breaker or fuse box.
- Check that the cycle is completed.

Dishwasher Adds Water at END of Cycle:

- This is normal. The Auto Clean (select models) sensor in the pump must stay submerged so a short fill of water is added after the cycle's last drain.

Detergent Cup Is Not Empty:

- Check that the cycle is completed.
- Be sure dispenser is not blocked by a dish or utensil.
- Use fresh detergent stored in a cool, dry place.

Dishwasher Seems Noisy:

- A water valve hiss during fill is normal.
- Water circulation sounds are normal.
- A thumping sound may be a wash arm bumping an item that is extending beyond the racks.
- Chopping or grinding sounds may be heard during drain as the internal food disposer chops hard items like fruit seeds, nuts, etc.
- Humming during the drain is normal.
- A snap noise is the detergent cup lid hitting the door liner when the dishwasher door is opened at the end of the cycle. This is normal.
- Proper installation affects the noise level.

Cycle Takes Too Long (Heating Delay Light Stays On):

- Tough Scrub™ or Tough Scrub™ Plus (select models) or Sanitize (select models) has been selected and the cycle is extended to heat water.
- Check to see that the incoming water temperature is 120-140° F (49-60° C).

Dishwasher has an Odor:

- Run dishes being held in the dishwasher through a Rinse Only cycle.
- Many dishwashers have a "new" smell when first installed. This will dissipate with use.
- Dishwasher may not be draining properly. (See "Dishwasher Will Not Drain" section.)
- For a strong odor, place baking soda in both sides of the detergent cup. Select Light Wash and allow the water to circulate for about 10 minutes. Interrupt the cycle by unlatching the door and let it stand overnight. Restart the dishwasher by latching the door and allow it to complete the cycle. A commercial dishwasher cleaning product such as Jet-Dry Dishwasher Cleaner* can also be used.

Dishwasher Leaks:

- Check that the dishwasher is level. (Refer to the Installation Instructions.)
- Suds can cause the dishwasher to overflow. Measure the detergent carefully and use only detergents designed for use in a dishwasher. Less detergent is needed in soft water. Try another brand if sudsing continues.
- Follow directions closely on how to add a forgotten item (pg. 7).
- Be sure the Rinse Aid lid is securely attached and not leaking.

Display Time Suddenly Drops or Increases by Several Minutes (select models):

- This is normal when the Auto Clean cycle (select models) is selected and the dishwasher decides to skip or add a drain and refill.

Glasses Are Cloudy/Spotted:

- Select Extra Rinse (select models).
- Check water temperature. Incoming water should be 120°-140° F (49-60° C).
- Always use a rinse aid.
- Confirm that the cloudiness is removable by soaking the item in white vinegar for approximately 5 minutes. If removed, the problem is due to hard water. Adjust detergent amount being used to match water hardness (pg. 5). Be sure detergent is fresh, stored properly and is a high quality brand.
- If cloudiness is not removable, it is **etching**. This is an erosion of the surface of the glassware and can be caused by water that is too hot, from using too much detergent or by prewashing. Detergent needs food soil to act upon. If etching has occurred, the glassware is permanently damaged. To prevent further etching, adjust the detergent amount to match the water hardness, stop prewashing, and be sure incoming water temperature is not greater than 140° F (60° C). Use water heating options only when incoming water temperature is below 120° F (49° C).

Food Soil Remains on Dishes:

- Check water temperature (pg 5).
- Run hot water at the sink before starting the dishwasher.
- Select Tough Scrub™ or Tough Scrub™ Plus (select models).
- Check water hardness and adjust detergent amount accordingly (pg. 5).
- Use fresh detergent stored in a cool dry place.
- Select proper cycle for the soil level.
- Load items so they do not block the wash arms or center tower (pg. 2-3).
- Load the utensil basket with some handles up and some down to prevent nesting.
- Do not place glasses over tines.
- Prior to loading, scrape off burnt on foods and wipe the starchy film from utensils used with pasta, rice and oatmeal. These soils require more energy than the rest of the load to clean.

Items Washed In The Dishwasher Or The Dishwasher Tub Itself Are Stained/Discolored:

- Aluminum utensils or pans can leave marks when they rub against other items. Leave a slight space between items.
- Iron deposits in the water can leave a yellow, brown or orange film on dishes or the dishwasher tub. A filter may be needed, check with a water treatment company. RoVer Rust Remover (part no. 057961)** can be used to remove rust. Do not use RoVer along with dishwasher detergent. Fill both cups with RoVer and complete a Normal Wash cycle. Follow with a short wash cycle using dishwasher detergent.
- Color from tomato sauces may adhere to the tub (pg. 8). If light staining has occurred, leave the door open to oxidize the stain away. For removal of heavier stains, try a citric acid containing dishwasher cleaning product such as Glisten (part no. 18001017)**. Change dishwasher detergent and be sure to use a dishwasher detergent that contains chlorine to better fight staining.

Items Not Properly Dried/Moisture Is Present On The Dishwasher Interior After The Dry Cycle:

- Be sure Heated Dry is selected.
- Water droplets may form on the inner door as part of the drying process.
- Always use a rinse aid like Jet Dry* or Cascade Rinse Aid*.
- Check water temperature (pg. 5).
- Select Tough Scrub™ or Tough Scrub™ Plus (select models).
- Increase detergent amount to match water hardness (pg. 5).
- Load properly (pg. 2-3)
- Plastic and teflon items are difficult to dry because the porous surface tends to collect water droplets. Towel drying may be necessary.
- Glasses and cups with concave bottoms hold water and require towel drying.

Dishware is Chipped:

- Load dishes according to instructions so they do not strike each other (pg. 2-3).
- Washing antique china/crystal in the dishwasher is not recommended.
- Do not load glasses over the tines.
- Do not overload.

Sanitized Light Does Not Illuminate at the End of the Cycle (select models):

- Sanitize was not selected.
- Sanitization can only be achieved with the Auto Clean (select models), Heavy, Light or Normal wash cycles.
- The incoming water temperature was too low, interfering with the dishwasher's ability to achieve adequate water heating in the allotted amount of time.

DISHWASHER WARRANTY

Full One Year Warranty

For ONE (1) year from the date of original retail purchase, any part which fails in normal home use will be repaired or replaced free of charge.

Limited Second Year Warranty

After the first year from the date of original retail purchase, through the second year, parts which fail in normal home use will be repaired or replaced free of charge for the part itself, with the owner paying all other costs, including labor, mileage and transportation.

Limited Third Through Fifth Year Warranty

After the second year from the date of original retail purchase, through the fifth year, all of the following components which fail in normal home use will be repaired or replaced free of charge for the part itself, with the owner paying all other costs, including labor, mileage and transportation. These components include:

Any parts of the Jetclean® system for all models, including the complete power module assembly, soil sensor, center spray nozzle, spray arms, top wash arm hose, and motor.

Computer Touch Control models only – any micro-processor and touch pad assemblies.

All models against rust, including exterior cabinet and front panels of portable models, the exterior front panels and accessory side panels of built-in models, and premium DuraGuard® coated racks (available on select models).

Full Twenty-Year Warranty

From the date of original purchase through the twentieth year, should the tub develop a water leak in normal home use, the dishwasher itself will be replaced **FREE OF CHARGE**.

From the date of original purchase through the twentieth year, should the door liner develop a water leak in normal home use, repair or replacement of the door liner will be made **FREE OF CHARGE**.

PLEASE NOTE: These full warranties apply only when the dishwasher is located in the United States or Canada. Dishwashers located elsewhere are covered by the limited warranties only, including a limited warranty for parts which fail during the first year.

Canadian Residents

These warranties cover only those dishwashers installed in Canada that have been listed with Canadian Standards Association unless the dishwashers are brought into Canada due to transfer of residence from the United States to Canada.

The specific warranties expressed above are the **ONLY** warranties provided by the manufacturer. These warranties give you specific legal rights, and you may also have other rights that vary from state to state.

WHAT IS NOT COVERED BY THESE WARRANTIES:

1. Conditions and damages resulting from any of the following:
 - a. Improper installation, delivery, or maintenance.
 - b. Any repair, modification, alteration, or adjustment not authorized by the manufacturer or an authorized servicer.
 - c. Misuse, abuse, accidents, or unreasonable use.
 - d. Incorrect electric current, voltage, or supply.
 - e. Improper setting of any control.
2. Warranties are void if the original serial numbers have been removed, altered, or cannot be readily determined.
3. Products purchased for commercial or industrial use.
4. The cost of service or service call to:
 - a. Correct installation errors.
 - b. Instruct the user on the proper use of the product.
 - c. Transport the appliance to the servicer.
5. Consequential or incidental damages sustained by any person as a result of any breach of these warranties. Some states do not allow the exclusion or limitation of consequential or incidental damages, so the above exclusion may not apply.

TO RECEIVE WARRANTY SERVICE

- To locate an authorized service company in your area contact the Maytag dealer from whom your appliance was purchased or call Maytag Appliances Sales Company, Maytag Customer Assistance at the number listed below. Should you not receive satisfactory warranty service, please call or write:

Maytag Appliances Sales Company

Attn: CAIR® Center

P.O. Box 2370

Cleveland, TN 37320-2370

U.S.

1-800-688-9900

CANADA

1-800-688-2002

U.S. customers using TTY for deaf, hearing impaired or speech impaired, call 1-800-688-2080.

NOTE: When writing or calling about a service problem, please include the following information:

- a. Your name, address and telephone number;
- b. Model number and serial number of your appliance ;
- c. Name and address of your dealer or servicer and the date the appliance was purchased;
- d. A clear description of the problem you are having;
- e. Water hardness, detergent brand and amount, water temperature and cycle used;
- f. Proof of purchase (sales receipt).

User's guides, service manuals and parts information are available from Maytag Appliances Sales Company, Maytag Customer Assistance.

Free Manuals Download Website

<http://myh66.com>

<http://usermanuals.us>

<http://www.somanuals.com>

<http://www.4manuals.cc>

<http://www.manual-lib.com>

<http://www.404manual.com>

<http://www.luxmanual.com>

<http://aubethermostatmanual.com>

Golf course search by state

<http://golfingnear.com>

Email search by domain

<http://emailbydomain.com>

Auto manuals search

<http://auto.somanuals.com>

TV manuals search

<http://tv.somanuals.com>