

RAA2400

Reference Series 2-Channel Amplifier

REFERENCE

Installation & Operation

Installation et fonctionnement

Instalación y funcionamiento

Einbau und Betrieb

Installazione e funzionamento

Установка и эксплуатация

INTRODUCTION

Dear Customer,

Congratulations on your purchase of the world's finest brand of car audio equipment. At MB Quart, we are pleased you chose our product. Through years of engineering expertise, hand craftsmanship and critical testing procedures, we have created a wide range of products that reproduce music with all the clarity and richness you deserve.

For maximum performance we recommend you have your new MB Quart product installed by an Authorized MB Quart Dealer. Please read your warranty and retain your receipt and original carton for possible future use.

Great product and competent installations are only a piece of the puzzle when it comes to your system. Make sure that your installer is using quality accessories in your installation. Poor quality RCA cables and speaker wire can effect the performance and sound quality of your system. When installing, or having your system installed, use the best. Insist on it! After all, your new system deserves nothing but the best.

To get a free brochure on MB Quart products and accessories, in the U.S. call 1-800-962-7757 or FAX 1-800-327-3777. For all other countries, call +49 6261 638-0 or FAX +49 6261 638-129.

PRACTICE SAFE SOUND™

Continuous exposure to sound pressure levels over 100dB may cause permanent hearing loss. High powered auto sound systems may produce sound pressure levels well over 130dB. Use common sense and practice safe sound.

If, after reading your manual, you still have questions regarding this product, we recommend that you see your MB Quart dealer. If you need further assistance, you can call us direct at 1-800-962-4412. Be sure to have your serial number, model number and date of purchase available when you call.

The serial number can be found on the outside of the box. Please record it in the space provided below as your permanent record. This will serve as verification of your factory warranty and may become useful in recovering your amplifier if it is ever stolen.

Serial Number: _____

Model Number: _____

TABLE OF CONTENTS

Introduction	2	Operation	9-10
Safety Instructions	3	Set-up Features	9
Design Features	4-5	Front End Defeat	9
Installation	5-9	Crossover	10
Installation Considerations	5	Gain	10
Mounting Locations	6	Troubleshooting	11-12
Battery and Charging	6	Specifications	12
Wiring the System	7	Limited Warranty Information	13

NOTE: Review each section for more detailed information.

GETTING STARTED

Welcome to MB Quart! This manual is designed to provide information for the owner, salesperson and installer. For those of you who want quick information on how to install this product, please turn to the Installation Section of this manual. Other information can be located by using the Table of Contents. We, at MB Quart, have worked very hard to make sure all the information in this manual is current. But, as we are constantly finding new ways to improve our product, this information is subject to change without notice.



SAFETY INSTRUCTIONS

WARNING

This symbol with "WARNING" is intended to alert the user to the presence of important instructions. Failure to heed the instructions will result in severe injury or death.

CAUTION

This symbol with "CAUTION" is intended to alert the user to the presence of important instructions. Failure to heed the instructions can result in injury or unit damage.

-  **CAUTION:** To prevent injury and damage to the unit, please read and follow the instructions in this manual. We want you to enjoy this system, not get a headache.
-  **CAUTION** If you feel unsure about installing this system yourself, have it installed by an authorized MB Quart dealer.
-  **CAUTION** Before installation, disconnect the battery negative (-) terminal to prevent damage to the unit, fire and/or possible injury.

CONTENTS OF CARTON

Model RAA2400 2-Channel Amplifier	(2) Speaker Plug Connectors
Installation & Operation Manual	(1) Power Plug Connector
Mounting Hardware Kit	(1) 8/32" Allen Wrench

The hardware kit included with each amplifier contains the mounting hardware necessary to secure the amplifier to the vehicle.

Visit our web site for the latest information on all MB Quart products.

www.mbquart.com

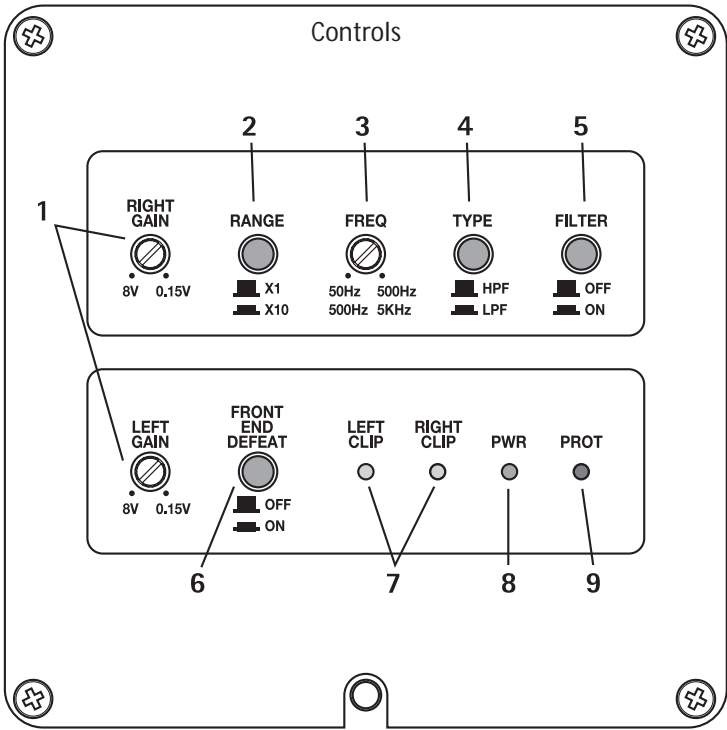

1. Gain Adjuster – These can be adjusted to match output levels from a variety of source units individually for the left and right inputs.
2. Crossover Multiplier Range Switch – Used to set the multiplier for the left and right crossover frequencies between x1 and x10. A setting of x1 leaves the adjustable crossover frequency from 50-500Hz. A setting of x10 changes the adjustable crossover frequency to 500-5KHz (5000Hz)
3. Crossover Frequency Adjuster– Used to adjust the left and right crossover frequency. Variable from 50Hz to 500Hz in x1 mode, and 500-5KHz in x10 mode.
4. Crossover Type – Is used for selecting High-Pass Filter (HPF) or Low-Pass Filter (LPF) operation for the left and right speaker outputs.
5. Crossover Filter Switch – Off sets the crossover to all-pass, adjustments to the crossover range, freq, and type are bypassed. On allows adjustments to the crossover settings to be used.
6. Front End Defeat – Used to reroute the input signal around the signal processing circuitry within the amplifier. While in the ON position, all gain and crossover functions are bypassed.
7. Clipping LED Indicators – These Yellow LEDs illuminate if clipping is detected for either the left or right speaker outputs.
8. Power LED – This Green LED illuminates when the unit is turned on.
9. Protect LED – This Red LED illuminates if a short circuit or too low of an impedance is detected at the speaker connections or if the amplifier reaches thermal protection. The amplifier will automatically shut down if this occurs.

Connections

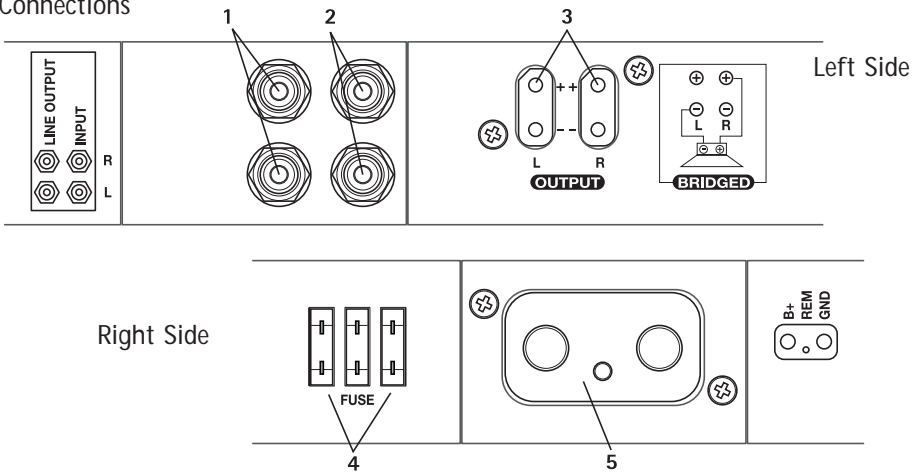

1. **RCA Line Output Jacks** – These outputs provide a convenient source for daisy-chaining an additional amplifier without running an extra set of RCA cables from the front of the vehicle. These are pass-thru only and are not effected by crossover or gain adjustments.
2. **RCA Input Jacks** – The industry standard RCA jacks provide an easy connection for line level input. They are plated to resist the signal degradation caused by corrosion.
3. **Speaker Plug Receptacle** – Receptacle for the speaker plug connector. These connectors (+ and –) will accept wire sizes from 12 AWG to 18 AWG.
4. **Fuses** – These ATC fuses are easily accessible in case of failure. Always replace fuses with same type and rating. See Specifications for fuse ratings.
5. **Power Plug Receptacle** – Receptacle for the power plug connector. The power (+12V DC) and ground wire connectors will accommodate up to a 2 AWG wire. The Remote wire connector will accommodate sizes from 12 AWG to 18 AWG. The Remote terminal is used to remotely turn-on and turn-off the amplifier when +12V DC is applied.

INSTALLATION

INSTALLATION CONSIDERATIONS

The following is a list of tools needed for installation:

- Volt/Ohm Meter
- Wire strippers
- Wire crimpers
- Wire cutters
- #2 Phillips screwdriver
- Battery post wrench

- Hand held drill w/assorted bits
- 1/8" diameter heatshrink tubing
- Assorted connectors
- Adequate Length—Red Power Wire
- Adequate Length—Remote Turn-on Wire
- Adequate Length—Black Grounding Wire

This section focuses on some of the vehicle considerations for installing your new amplifier. Pre-planning your system layout and best wiring routes will save installation time. When deciding on the layout of your new system, be sure that each component will be easily accessible for making adjustments.

INSTALLATION



CAUTION: If you feel unsure about installing this system yourself, have it installed by a authorized MB Quart Dealer.



CAUTION: Before installation, disconnect the battery negative (-) terminal to prevent damage to the unit, fire and/or possible injury.

Before beginning any installation, follow these simple rules:

1. Be sure to carefully read and understand the instructions before attempting to install the unit.
2. For safety, disconnect the negative lead from the battery prior to beginning the installation.
3. For easier assembly, we suggest you run all wires prior to mounting your unit in place.
4. Route all of the RCA cables close together and away from any high current wires.
5. Use high quality connectors for a reliable installation and to minimize signal or power loss.
6. Think before you drill! Be careful not to cut or drill into gas tanks, fuel lines, brake or hydraulic lines, vacuum lines or electrical wiring when working on any vehicle.
7. Never run wires underneath the vehicle. Running the wires inside the vehicle provides the best protection.
8. Avoid running wires over or through sharp edges. Use rubber or plastic grommets to protect any wires routed through metal, especially the firewall.
9. ALWAYS protect the battery and electrical system from damage with proper fusing. Install the appropriate fuse holder and fuse on the +12V power wire within 18" (45.7 cm) of the battery terminal.
10. When grounding to the chassis of the vehicle, scrape all paint from the metal to ensure a good, clean ground connection. Grounding connections should be as short as possible and always be connected to metal that is welded to the main body, or chassis, of the vehicle.

MOUNTING LOCATIONS

Engine Compartment

Never mount this unit in the engine compartment. Mounting the unit in the engine compartment will void your warranty.

Trunk Mounting

Mounting the amplifier vertically will provide adequate cooling of the amplifier.

Mounting the amplifier on the floor of the trunk will provide the best cooling of the amplifier.

Mounting the amplifier upside down to the rear deck of the trunk will not provide proper cooling and will severely affect the performance of the amplifier and is strongly not recommended.

Passenger Compartment Mounting



Mounting the amplifier in the passenger compartment will work as long as you provide a sufficient amount of air for the amplifier to cool itself. If you are going to mount the amplifier under the seat of the vehicle, you must have at least 1" (2.54cm) of air gap around the amplifier's fan intake and top exhaust vents.

Mounting the amplifier with less than 1" (2.54cm) of air gap around the amplifier in the passenger compartment will not provide proper cooling and will severely affect the performance of the amplifier and is strongly not recommended.

BATTERY AND CHARGING

Amplifiers will put an increased load on the vehicle's battery and charging system. We recommend checking your alternator and battery condition to ensure that the electrical system has enough capacity to handle the increased load of your stereo system. Stock electrical systems which are in good condition should be able to handle the extra load of any MB Quart amplifier without problems, although battery and alternator life can be reduced slightly. To maximize the performance of your amplifier, we suggest the use of a heavy duty battery and an energy storage capacitor.

WIRING THE SYSTEM

-  **CAUTION:** If you do not feel comfortable with wiring your new unit, please see your local authorized MB Quart Dealer for installation.
-  **CAUTION:** Before installation, disconnect the battery negative (-) terminal to prevent damage to the unit, fire and/or possible injury.
-  **CAUTION:** Avoid running power wires near the low level input cables, antenna, power leads, sensitive equipment or harnesses. The power wires carry substantial current and could induce noise into the audio system.

1. Plan the wire routing. Keep RCA cables close together but isolated from the amplifier's power cables and any high power auto accessories, especially electric motors. This is done to prevent coupling the noise from radiated electrical fields into the audio signal. When feeding the wires through the firewall or any metal barrier, protect them with plastic or rubber grommets to prevent short circuits. Leave the wires long at this point to adjust for a precise fit at a later time.
2. Remove the four (4) 8/32 allen head screws holding the connection end cover in place (this is the end without the vents for the fans). Keep the cover and screws in a safe place for reinstallation when mounting and wiring is complete.
3. Prepare the RED wire (power cable) by stripping 1/2" of insulation from the end of the wire. Insert the bared wire into the "+" terminal on the plug connector. Tighten the set screw with a 3/32" allen wrench to secure the cable in place.

NOTE: The "+" (positive) cable **MUST** be fused 18" or less from the vehicle's battery. Install the fuseholder under the hood and ensure connections are water tight.

4. Trim the RED wire (power cable) within 18" of the battery and splice in a inline fuse holder. See Specifications for the rating of the fuse to be used. **DO NOT** install the fuse at this time.
5. Strip 1/2" from the battery end of the power cable and crimp a large ring terminal to the cable. Use the ring terminal to connect to the battery positive terminal.
6. Prepare the BLACK wire (Ground cable) by stripping 1/2" of insulation from the end of the wire. Insert the bared wire into the "-" terminal on the plug connector. Tighten the set screw with a 3/32" allen wrench to secure the cable in place. Prepare the vehicle chassis ground by scraping any paint from the metal surface and thoroughly clean the area of all dirt and grease. Strip the other end of the wire and attach a ring connector. Fasten the cable to the chassis using a non-anodized screw and a star washer.

NOTE: Keep the length of the BLACK wire (Ground) as short as possible. Always less than 30"(76.2cm).

7. Prepare the Remote turn-on wire by stripping 1/2" of insulation from the end of the wire. Insert the bared wire into the "R" terminal on the plug connector. Tighten the set screw with a 3/16" allen wrench to secure the cable in place. Connect the other end of the Remote wire to a switched 12 volt positive source. The switched voltage is usually taken from the source unit's accessory lead. If the source unit does not have this output available, the recommended solution is to wire a mechanical switch in line with a 12 volt source to activate the amplifier manually.

Power Connection

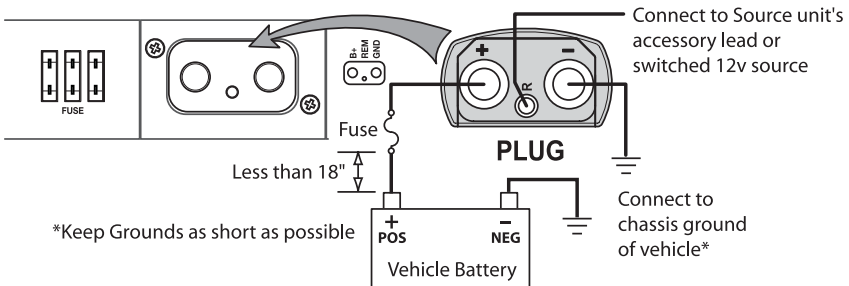

INSTALLATION

- Securely mount the amplifier to the vehicle or amp rack. Be careful not to mount the amplifier on cardboard or plastic panels. Doing so may enable the screws to pull out from the panel due to road vibration or sudden vehicle stops.
- Connect source signal by plugging the RCA cables into the input jacks at the amplifier.

CAUTION: Always ensure power is off or disconnected at the amplifier before connecting RCA cables. Failure to do so may cause injury, damage to the amplifier and/or connected components.

- Connect the speakers. Strip the speaker wires 1/2" and insert into the speaker plug connector and tighten the set screw to secure into place. Be sure to maintain proper speaker polarity. DO NOT chassis ground any of the speaker leads as unstable operation may result.
- Perform a final check of the completed system wiring to ensure that all connections are accurate. Check all power and ground connections for frayed wires and loose connections which could cause problems.
- Ensure the amplifier is mounted securely and reinstall the end cover. Install an inline fuse near the battery connection.

NOTE: Follow the diagrams for proper signal polarity.

CAUTION: These amplifiers are not recommended for impedance loads below 2 Ω stereo and 4 Ω bridged (mono).

CAUTION: Do not attempt to connect the source units speaker leads directly to the RCA connections of this amplifier, as damage to the source unit and/or the amplifier may result.

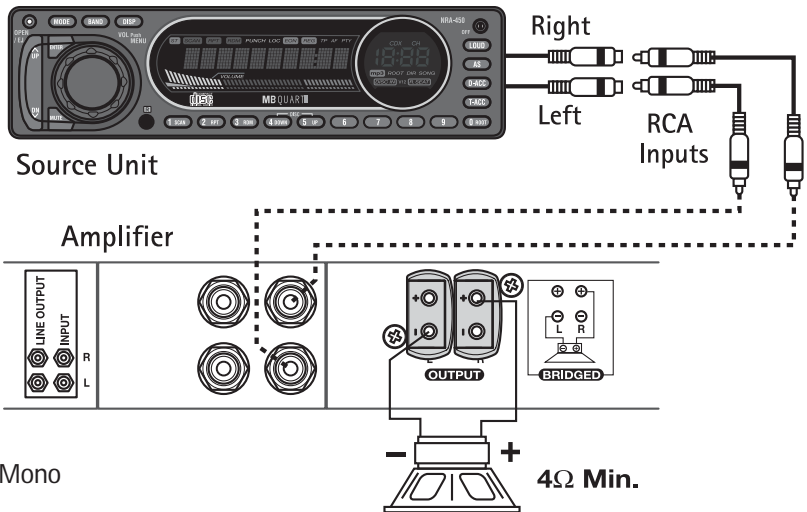

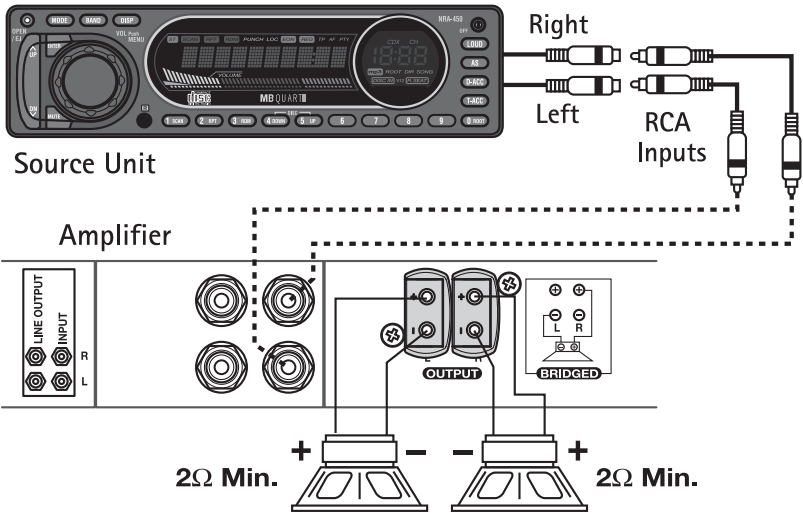

SET-UP FEATURES

The MB Quart R Series amplifier offers a wide range of selections for the user to create a listening environment that meets your personal preference.

Before making final adjustments, read through the descriptions for each feature to get the best results.

ADJUSTMENTS

Loosen the allen screw holding the small cover in place over the controls. Tilt the cover up and away from the amplifier. After making adjustments, always ensure the cover is in place to prevent accidental changes to the settings.

NOTE: Failure to follow these instructions may result in a loss of sonic quality. This is caused by premature activation of the protection circuitry to maintain the integrity of the amplifiers sensitive components. The performance specifications listed in this manual cannot be guaranteed under such conditions.

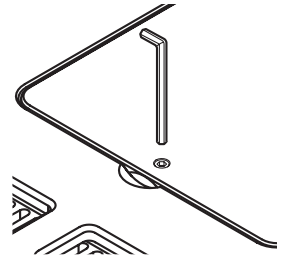

FRONT END DEFEAT

The front-end defeat switch is responsible for rerouting the signal around the signal processing circuitry within the amplifier. This feature was designed for use with external processors to provide the purest possible signal path through the amplifier.

With this configuration, the MB Quart R Series amplifiers are able to provide lower distortion and better signal reproduction due to the reduction in the number of components in the signal path. Bypassing the crossover will also eliminate the typical phase shift associated with the analog filter transform function. While the Front End Bypass is turned on, all adjustments made to the gain or crossover will be bypassed.

CROSSOVER

Filter Switch

Placing the switch in the ON position (In Position) sets the amplifier to the All Pass mode, preventing any crossover adjustment, allowing all frequencies to pass. Adjustments made to the Multiplier switch or Frequency Adjuster are bypassed.

Frequency Switch

Placing the switch in the HPF position (In Position) sets the amplifier to the High Pass mode, enabling frequencies above the cut-off point to pass.

Placing the switch in the LPF position (Out Position) sets the amplifier to the Low Pass mode, enabling frequencies below the cut-off point to pass.

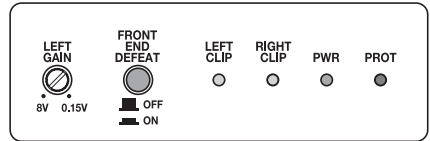
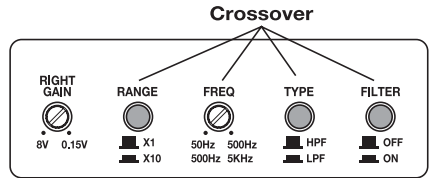

Multiplier Switch

This switch sets the multiplier for the crossover frequencies.

Placing the switch in the x10 position (In Position) sets the adjustable crossover frequency to 500-5KHz (5000Hz).

Placing the switch in the x1 position (Out Position) sets the adjustable crossover frequency to 50-500Hz.

Frequency Adjustment

After setting the Frequency Switch and Multiplier Switch, use the Frequency Adjuster to set the desired cut-off point.

Turning the adjuster counter-clockwise decreases the set frequency.

Turning the adjuster clockwise increases the set frequency.

Quick Setting: Decrease the crossover frequency all the way down. With the system playing, increase the crossover frequency up slowly until the desired crossover point is achieved.

GAIN

Do the following individually for each channel.

Turning the adjuster clockwise decreases the set gain.

Turning the adjuster counter-clockwise increases the set gain.

1. To adjust the gain setting, turn the amplifier gains all the way down (clockwise).
2. Turn the source unit volume up until distortion is audible and then turn it down a bit until the distortion is inaudible. This will be about all the way up on most source units.
3. Increase the amplifier gain setting until adequate volume is achieved or clipping is noted by the LED indicators. Turn the gain down slightly if clipping is indicated.

Most quality source units do not distort, so the volume can be used at maximum setting.

NOTE: Best signal to noise and dynamic range are realized with the gain at minimum. Most users find adequate gain and volume is achieved at about halfway in the adjustment range.

CAUTION: Avoid setting the amplifier gain very high as noise and distortion will increase significantly.

NOTE: For a more in depth setting procedure, contact MB Quart Technical Support.

Amplifier Does Not Turn On

Possible Cause	Solution
The in-line fuse on battery positive cable is blown.	Check in-line fuse on battery positive cable. Replace if necessary.
Poor ground connection	Verify that Ground connection is connected to clean metal on the vehicle's chassis. Repair/replace if necessary.
Poor power connection or power outside acceptable range.	Verify there is 10.5 - 15.5 Volts present at the positive battery and remote turn-on cable. Verify quality connections for both cables at amplifier, stereo, and battery/fuseholder. Repair/replace if necessary.

No Sound Coming From Amplifier

Possible Cause	Solution
Poor RCA connections.	Verify good RCA input connections at source and amplifier. Check entire length of cables for kinks, splices, etc. Test RCA inputs for AC voltage with the source unit on. Repair/replace if necessary
Poor speaker connections	Use an ohm meter to check speaker wire integrity. Check entire length of wires for kinks, splices, etc. Repair/replace if necessary.
Bad source unit	Connect RCA input from test source directly to amplifier input. If this solves the problem, have the source unit repaired or replaced. If not, have the amplifier checked by a qualified technician.

Speaker "Pop" When Amplifier Turns On

Possible Cause	Solution
Remote from source unit comes on too quickly.	Disconnect input signal to amplifier and turn amplifier on and off. If the noise is eliminated, connect the REM lead of amplifier to source unit with a delay turn-on module
Poor remote power signal from source	Use a different 12 Volt source for REM lead of amplifier (i.e. battery direct). If the noise is eliminated, use a relay to isolate the amplifier from noisy turn-on output.

Excessive Engine Noise

Possible Cause	Solution
RCA cables too close to main power cables.	Route all signal carrying wires (RCA, Speaker cables) away from power and ground wires.
Bad component in the signal chain	Bypass any and all electrical components between the source and the amplifier(s). Connect source directly to input of amplifier. If noise goes away the unit being bypassed is the cause of the noise.
Poor ground connection at system components	Remove existing ground wires for all electrical components. Reground wires to different locations. Verify that grounding location is clean, shiny metal free of paint, rust etc
Poor ground connection at battery	Add secondary ground cable from negative battery terminal to the chassis metal or engine block of vehicle.

TROUBLESHOOTING

PROT (Protect) LED Comes On, Amplifier shuts down

Possible Cause	Solution
There is a short in the system	Turn the system off. Check connection to all components for possible shorts. Check all wires and cables for kinks, splices, poor insulation, etc. Repair/replace if necessary.
Amplifier has exceeded normal operating temperature due to improper ventilation.	Turn the system off and allow to cool. Verify adequate ventilation around amplifier. Move the amplifier to a spot with better ventilation if needed.
Speaker impedance too low	Check for proper speaker impedance, replace if needed.
Low battery voltage	Check that the vehicle charging system is maintaining proper voltage.

SPECIFICATIONS

MODEL- R Series	RAA2400
Continuous Power Rating (RMS) - Measured at 14.4 Battery Volts	
4 Ω Load Per Channel	200 Watts x 2Ch and A 1% THD+N
2 Ω Load Per Channel	400 Watts x 2Ch and A 1% THD+N
4 Ω Load Bridged (Mono)	800 Watts x 1Ch and A 1% THD+N
Dimensions:	
Height	2.375" (6cm)
Width	11.5" (29.2cm)
Length	16.75" (42.5cm)
Amplifier Fuse Rating (Amp/Type)	(3) 30A / ATC
Battery Fuse Rating (Amp) External (Not Supplied)	90A
Signal-to-Noise Ratio	>80dB A-weighted (reference: 0dB = 2Vrms)
Crossover	Selectable HPF/LPF or Off (High Pass / Low Pass or All Pass)
Crossover Slope	12dB/octave Butterworth
Crossover Frequency (Multiplier X1)	variable from 50Hz to 500Hz
Crossover Frequency (Multiplier X10)	variable from 500Hz to 5KHz
Frequency Response	0.25Hz to 100kHz (-3dB, 1watt)
Rated Bandwidth	20Hz to 20kHz
Signal Voltage Adjustment Range (RCA Input)	Variable from 0.15V to 8V
Protection	Shorted output, DC offset, thermal, power supply over-current
Input Impedance	20k ohms

These specifications are Amplifier Power Standard CEA-2006 Compliant

Specifications subject to change without notice

MB Quart Corporation offers a limited warranty on MB Quart products on the following terms:

Length of Warranty

R Series Amplifiers – 1 Year

Or, two (2) years warranty if installed by a Authorized MB Quart Dealer. Requires proof of purchase.

What is Covered

This warranty applies only to MB Quart products sold to consumers by Authorized MB Quart Dealers in the United States of America or its possessions. Product purchased by consumers from an Authorized MB Quart Dealer in another country are covered only by that country's Distributor and not by MB Quart.

Who is Covered

This warranty covers only the original purchaser of MB Quart product purchased from an Authorized MB Quart Dealer in the United States. In order to receive service, the purchaser must provide MB Quart with a copy of the receipt stating the customer name, dealer name, product purchased and date of purchase.

Products found to be defective during the warranty period will be repaired or replaced (with a product deemed to be equivalent) at MB Quart's discretion.

What is Not Covered

1. Damage caused by accident, abuse, improper operations, water, theft, shipping
2. Any cost or expense related to the removal or reinstallation of product
3. Service performed by anyone other than MB Quart or an Authorized MB Quart Service Center
4. Any product which has had the serial number defaced, altered, or removed
5. Subsequent damage to other components
6. Any product purchased outside the U.S.
7. Any product not purchased from an Authorized MB Quart Dealer

Limit on Implied Warranties

Any implied warranties including warranties of fitness for use and merchantability are limited in duration to the period of the express warranty set forth above. Some states do not allow limitations on the length of an implied warranty, so this limitation may not apply. No person is authorized to assume for MB Quart any other liability in connection with the sale of the product.

How to Obtain Service

Contact the Authorized MB Quart Dealer you purchased this product from.

If you need further assistance, call 1-800-962-4412 for MB Quart Customer Service. You must obtain an RA# (Return Authorization number) to return any product to MB Quart. You are responsible for shipment of product to MB Quart.

EU Warranty

This product meets the current EU warranty requirements, see your Authorized dealer for details.

Ship to: Electronics

MB Quart

Warranty Repair Department

2055 E. 5th Street

Tempe, AZ 85281

RA#: _____

MBQUART

German Engineering

MB QUART GmbH
Neckarstraße 20
D-74847 Obrigheim
Phone +49 6261 638-0
Fax +49 6261 638-129
Website www.mbquart.de
E-Mail info@mbquart.de

MB QUART Electronics
2055 E. 5th Street
Tempe, AZ 85281 USA
Phone 800 962-4412
Fax 800 398-3985
Website www.mbquart.com
E-Mail info@mbquart.com

03/04 B.M.
MAN-5624-A

Printed in Korea

Free Manuals Download Website

<http://myh66.com>

<http://usermanuals.us>

<http://www.somanuals.com>

<http://www.4manuals.cc>

<http://www.manual-lib.com>

<http://www.404manual.com>

<http://www.luxmanual.com>

<http://aubethermostatmanual.com>

Golf course search by state

<http://golfingnear.com>

Email search by domain

<http://emailbydomain.com>

Auto manuals search

<http://auto.somanuals.com>

TV manuals search

<http://tv.somanuals.com>