

Zurich Series

In-Wall & In-Ceiling Speakers

MAXXSONICS USA, INC.
1290 Ensell Road
Lake Zurich, Illinois 60047 USA
Phone +1 847 - 540 - 7700
FAXX +1 847 - 540 - 9776
E-Mail info@maxxsonics.com
Website www.maxxsonics.com

MAXXSONICS EUROPE GMBH
Neckarstraße 20
74847 Obrigheim, Germany
Phone +49 (0) 62 61 - 6 38-0
FAXX +49 (0) 62 61 - 6 38-129
E-Mail info@mbquart.de
Website www.mbquart.de



Installation & Operation

ZUR5.25IC / ZUR6.5IC / ZUR6.5IC DM / ZUR5.25IW / ZUR6.5IW

ZURICH SERIES

MB QUART IN-CEILING / IN-WALL SPEAKER INSTALLATION INSTRUCTIONS

Thank you for purchasing the MB QUART In-Ceiling / In-Wall speaker system.

To ensure proper installation and operation of the speakers, please follow the manual carefully and thoroughly.

- Be sure to follow the directions carefully and in the order provided below.
- Do not discard the manual. You will need this for future speaker removal and installation.
- Be sure to adhere to all of the safety and caution tips through out the manual.
- Do not install or operate the speakers near water.
- During the installation, be sure to avoid in-wall and in-ceiling heater/AC ducts, electrical power lines, plumbing and fire retardant insulation.
- Avoid direct exposure to heat producing sources such as heat ducts, and exhaust vents.
- Do not alter the physical elements of the assembly such as the enclosure, speaker grille or electrical contact points.
- Route speaker wires away from heat producing sources, moving parts and exposure to water.
- Use a clean dry cloth to clean the speakers when necessary.
- Refer all service to a qualified authorised service center.

Minimum Tool Required

- Wire Strippers
- Carpenters Level
- # 2 Phillips Screwdriver
- Flat Blade Screwdriver
- Electronic Stud Finder
- Drywall Hand Saw
- Miniature Flat Blade Screwdriver for Point Source Speakers

Material Supplied

- Grille Removal Tool
- Speaker Cut-Out Template
- Paint Shield
- Owner / Install manual

IN-CEILING SPEAKER PLACEMENT (ZUR5.25IC / ZUR6.5IC / ZUR6.5IC DM)

These speakers are designed to operate in a standard drywall or suspended acoustical panel ceiling. The speaker enclosure allows for different mounting depths that may be encountered in different ceiling applications.

Although the speakers sound best when the back section of the speaker is left in tact.

The back section of the speaker can be removed to lessen the over all mounting height if needed.

Some building codes may require that the back enclosure half be removed so please check with your local building codes.

When mounting to a drywall ceiling, be sure the drywall is at least 3/8" thick.

If you are mounting the speakers to typical acoustical suspended ceiling panels, you will need to reinforce the acoustical panel with 1/2" plywood to ensure the speaker does not cause the acoustical panel to sag over time.

1. Choose mounting locations that are equal distance left and right of the listening area as shown in **DIAGRAM 1**.

2. Use the speaker cut-out template supplied to mark your hole locations.

(Be sure there is clearance behind the area you have chosen for the speaker. Avoid electrical wiring, plumbing, moving parts, air ducts and Fire Stops.

3. Use a drywall saw or other appropriate tool to carefully cut out the speaker holes. The cut-out is the exact size required for the speaker. You also can go as much as 1/4" over this size as "Mistake Room".
4. Connect the speaker wires (18 gauge wire not supplied) to the speakers as shown in **DIAGRAM 2**. (Be sure to get the + and - polarity correct)
5. Place the speaker into the speaker opening and using a # 2 phillips screw driver, turn the Dog-Ear fastening screws clockwise (be sure to support the weight of the speaker until all Dog-Ear screws are securely tightened).

The Dog-Ear Tabs will rotate away from the speaker enclosure and begin to tighten against the mounting surface to secure the speaker as shown in **DIAGRAM 3**.

6. Carefully route the speaker wires to the amplifier or other power source. Be sure to avoid moving parts, heat producing items and water exposure.

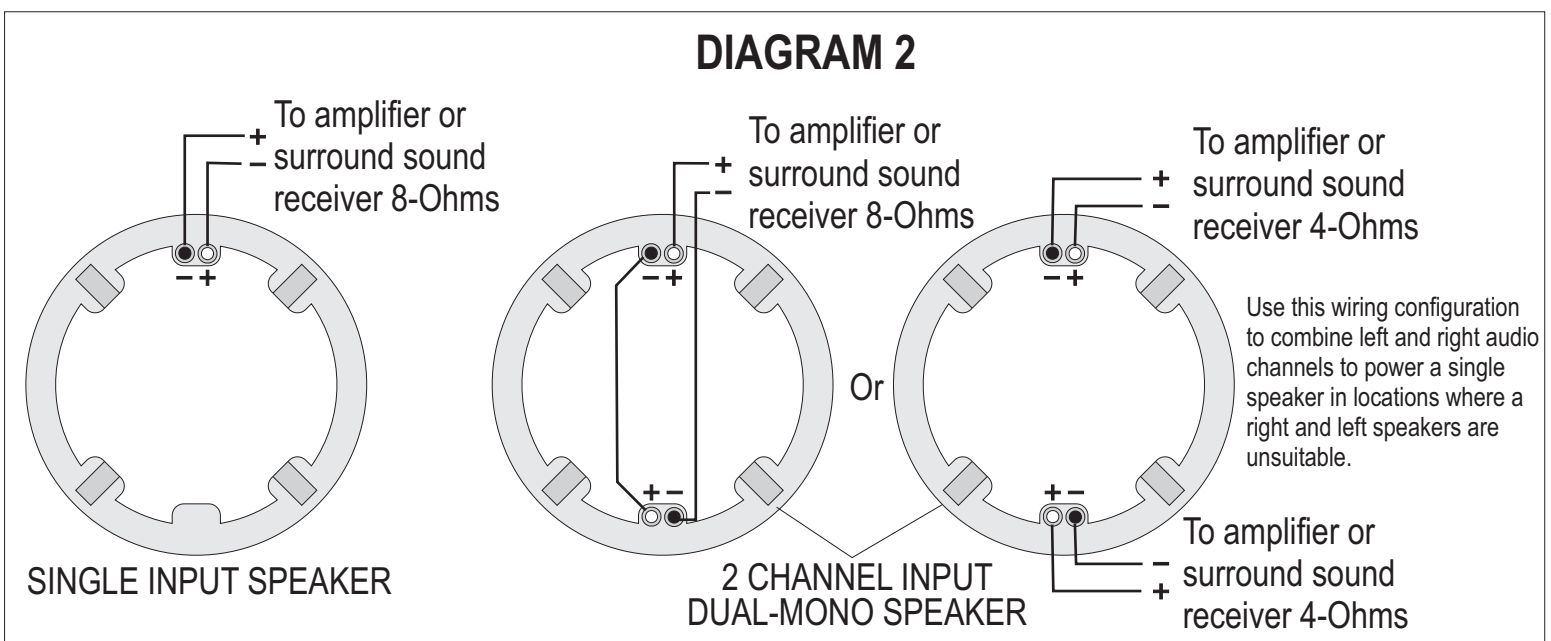
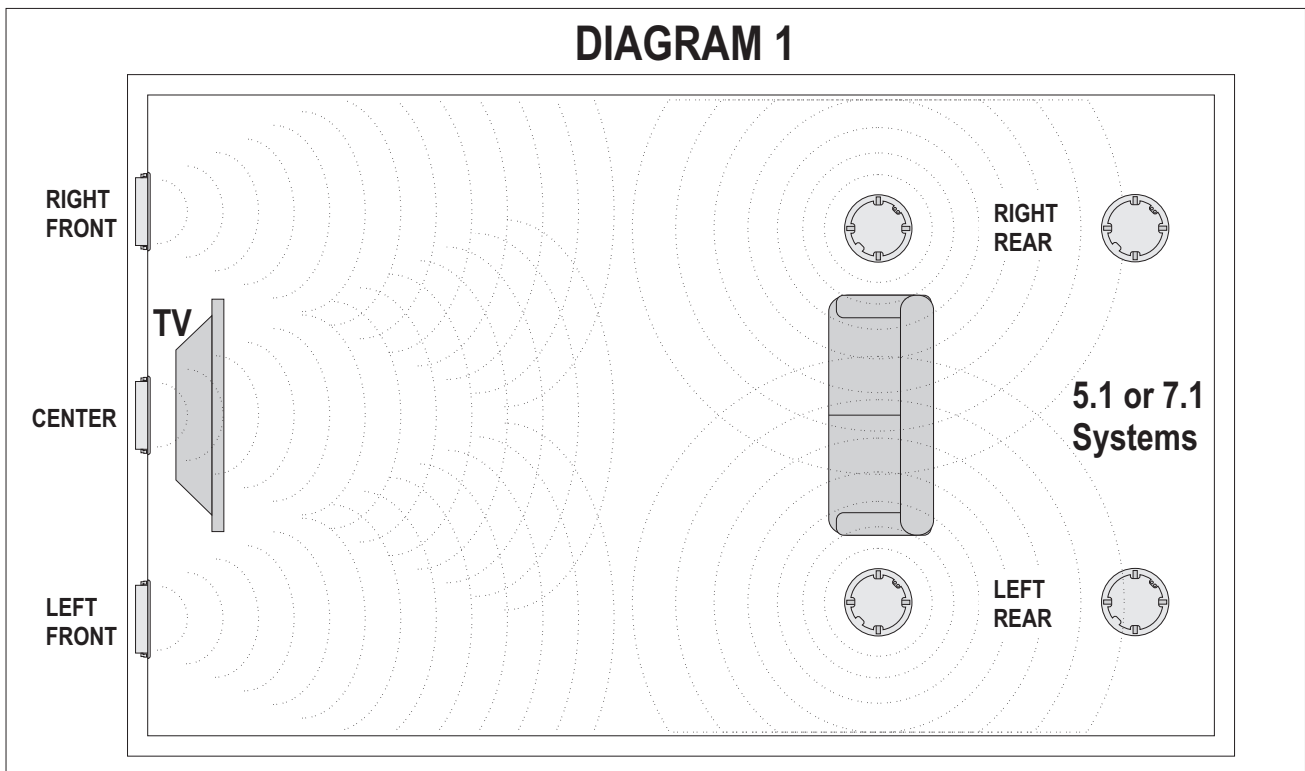
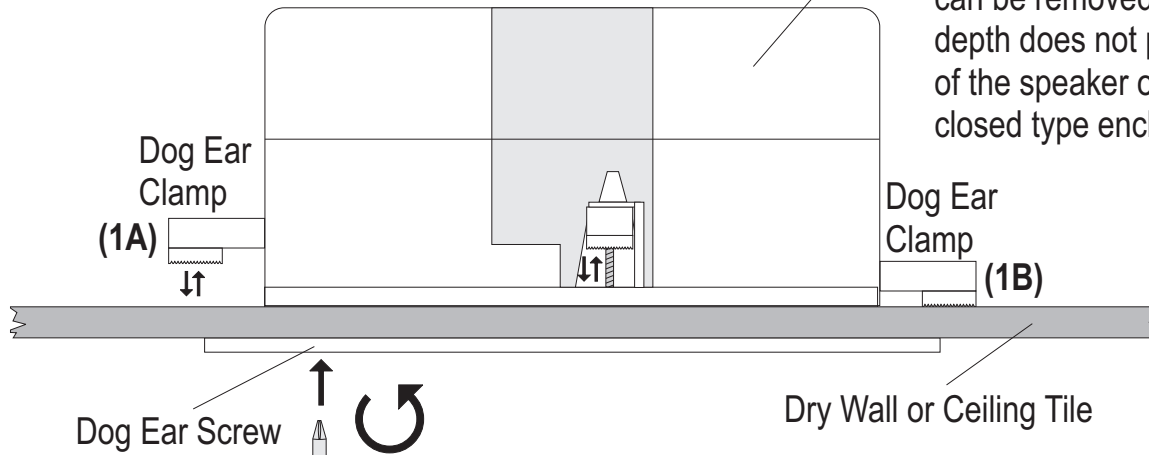

DIAGRAM 3

Removable enclosure back-case half

The back section of the enclosure can be removed when mounting depth does not permit the full height of the speaker or fire codes prevent closed type enclosures.



Note: As you turn the Dog-Ear screws clockwise, the Dog-Ear Clamp will swing out away from the speaker (1A). Continue to turn the screw and the Dog-Ear Clamp will Lower down until they reach the mounting surface (1B)

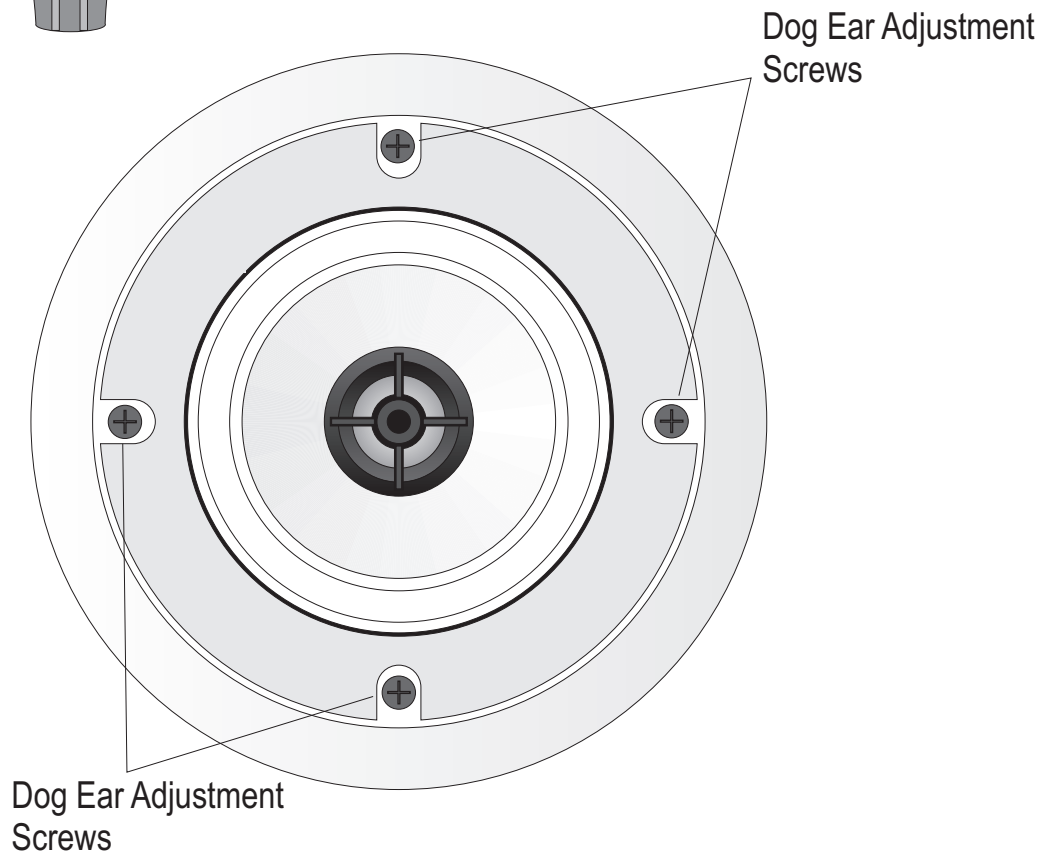

IN-WALL SPEAKER PLACEMENT (ZUR5.25IW / ZUR6.5IW)

These speakers are designed to operate in a standard drywall or wood paneling type wall.

The speakers feature removable back enclosure half that permits extremely shallow mounting conditions when necessary. You can mount the speakers vertical or horizontal and may be used for left / right main speakers or center channel as well as mirror imaged set-up.

1. Choose mounting locations that are equal distance left and right of the listening area as shown in **DIAGRAM 4**.
2. Use the speaker cut-out template supplied to mark your hole locations.
(Be sure there is clearance behind the area you have chosen for the speaker. Avoid electrical wiring, plumbing, moving parts, air ducts and Fire Stops.)
3. Use a drywall saw or other appropriate tool to carefully cut out the speaker holes. The cut-out is the exact size required for the speaker. You also can go as much as 1/4" over this size as "Mistake Room".
4. Connect the speaker wires (16 gauge wire not supplied) to the speakers as shown in **DIAGRAM 5**.
(Be sure to get the + and - polarity correct)
5. Place the speaker into the speaker opening and using a # 2 phillips screw driver, turn the Dog-Ear fastening screws clockwise (be sure to support the weight of the speaker until all Dog-Ear screws are securely tightened).
The Dog-Ear Clamp will rotate away from the speaker enclosure and begin to tighten against the mounting surface to secure the speaker as shown in **DIAGRAM 6**.
6. Carefully route the speaker wires to the amplifier or other power source. Be sure to avoid moving parts, heat producing items and water exposure.

DIAGRAM 4

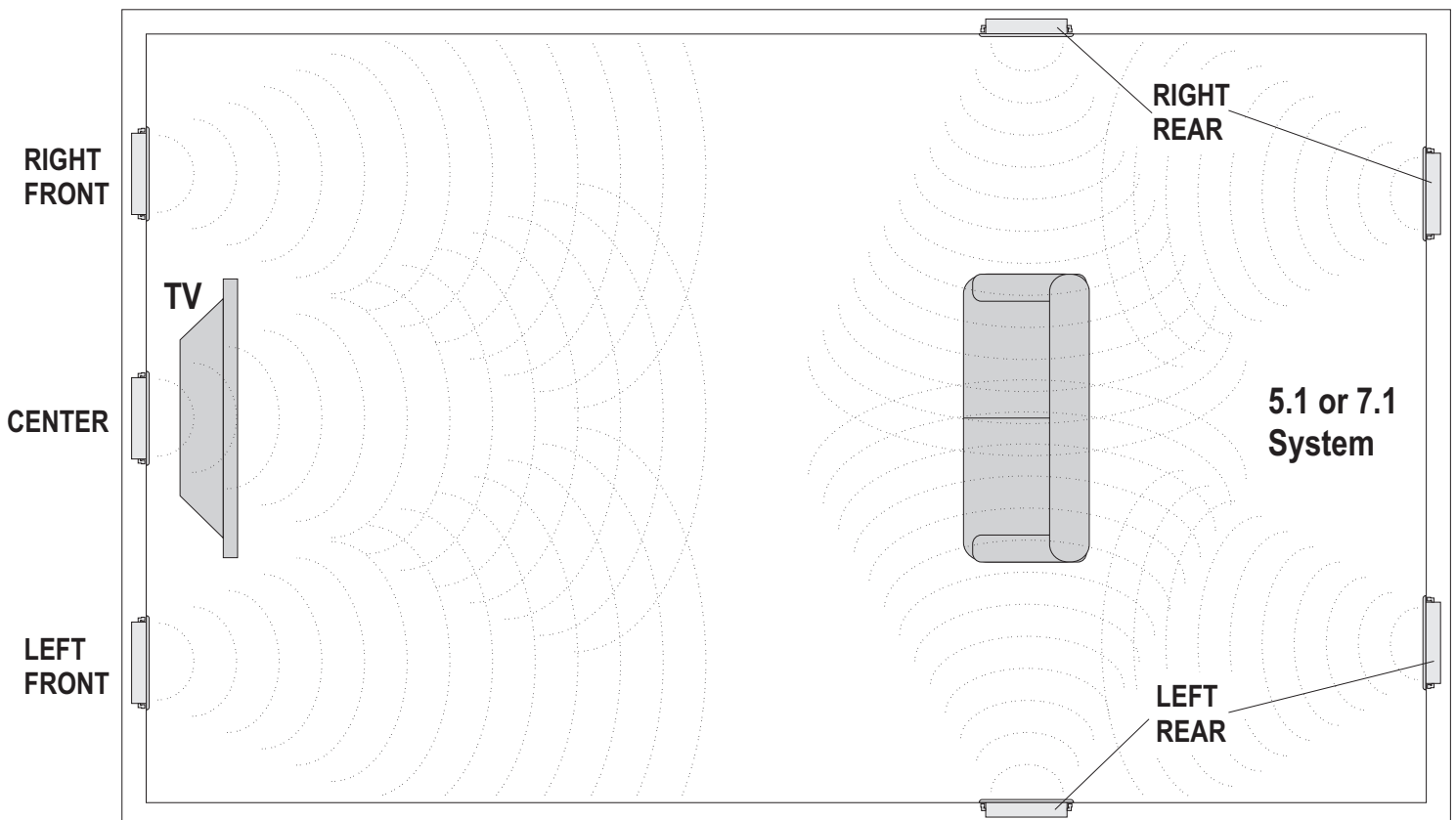

DIAGRAM 5

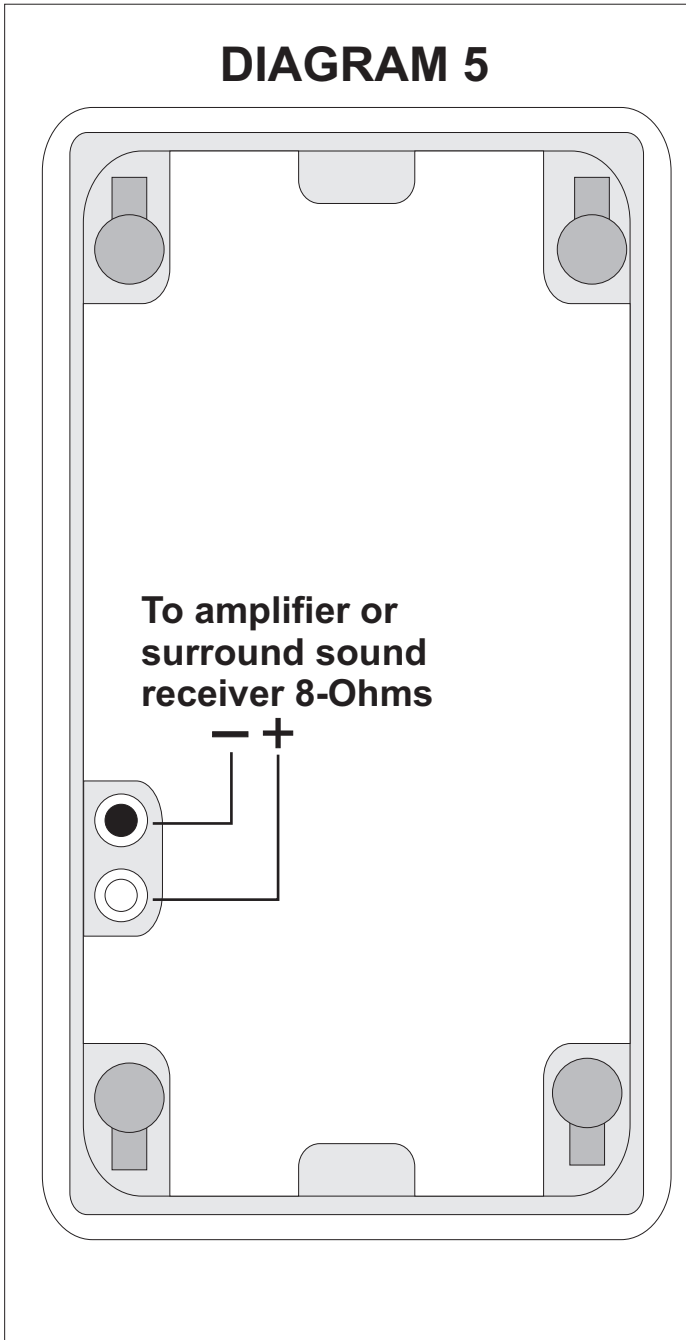
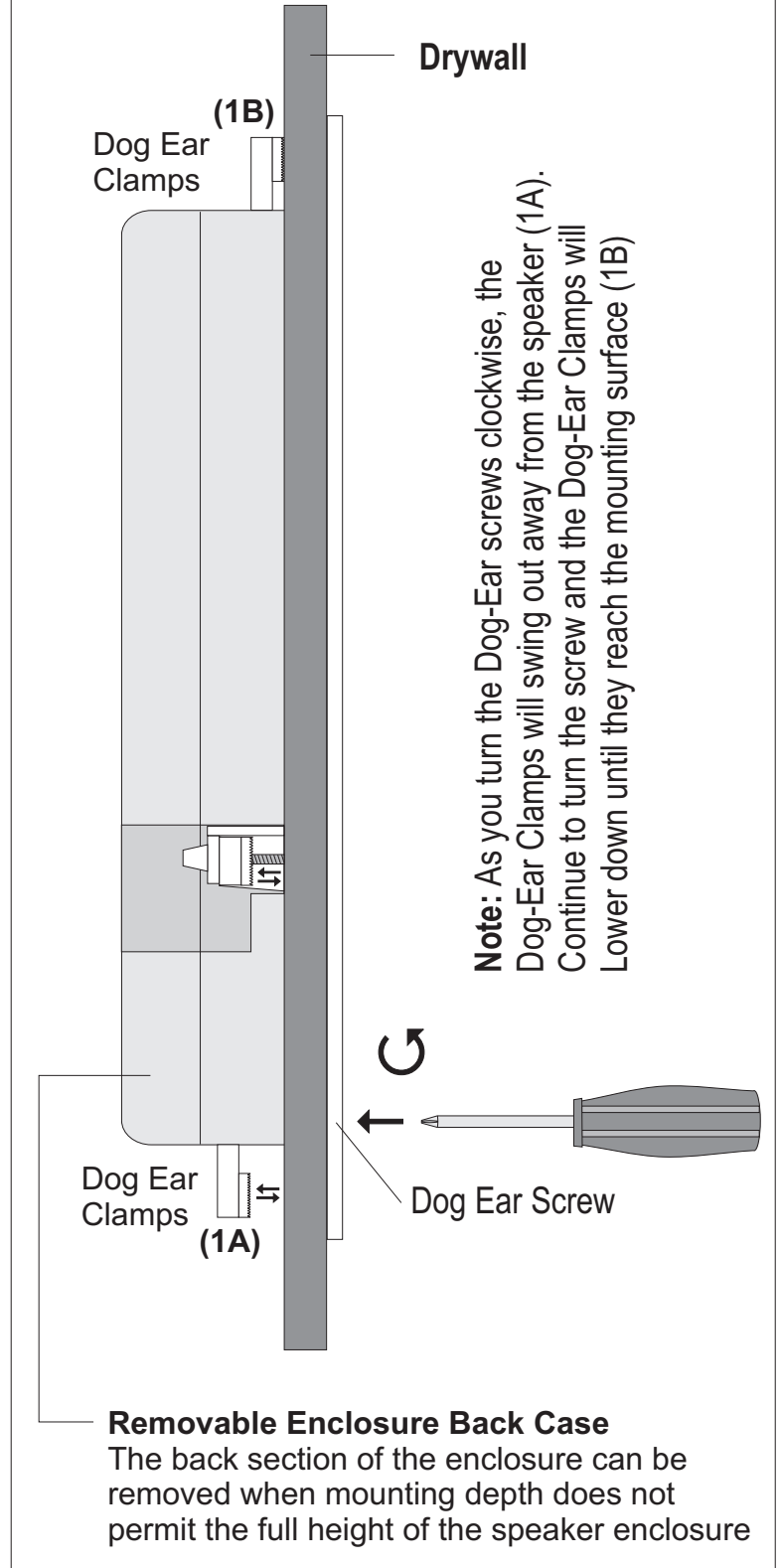
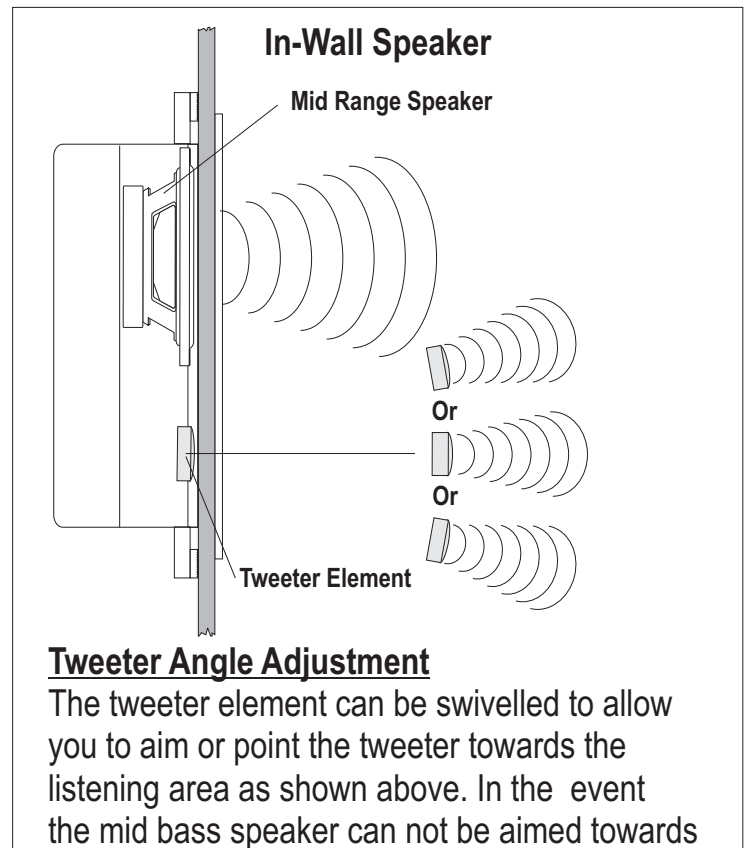
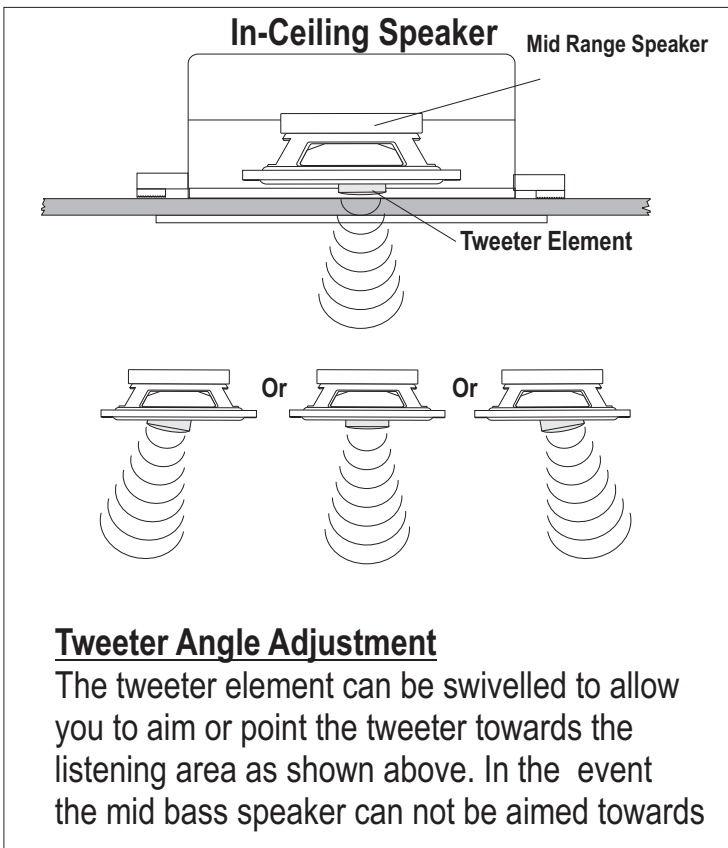

DIAGRAM 6



ADDITIONAL INSTALLATION AND OPERATIONAL INFORMATION

- If you do not have the installation cut-out template, the cut-out dimensions are also located on the speaker label located on the side of the speaker. You can also download the template by going to our website at: www.maxxsonics.com
- The speaker trim bezels and grilles can also be spray painted.
There is a paint shield located in the speaker kit to prevent from getting paint on the speaker cone.
Tip: Do not use roll-on paint because it will fill-in the holes in the grille which will dramatically effect the sound quality.
Be sure to paint the grille separate from the speaker and do not re-install the grille until the paint has dried.
- You may order additional parts such as Dog-Ear Clamps, Grilles, Grille removal tools by contacting Maxxsonics at www.maxxsonics.com
- **To enhance your total Surround Sound experience, be sure to consider the ZUR10SW or ZUR12SW powered subwoofer system which will provide heart pounding bass to your favorite action movies. For the ultimate in Hi Fi sound quality, check out the MB QUART 5.1 speaker systems (Tower speakers, center channel and book shelf speakers)**



ZURICH SPEAKER SPECIFICATIONS

MODEL	POWER RATING	IMPEDANCE	CUT-OUT"
ZUR5.25IC	80 WATTS	8-Ohms / 6-Ohms nom.	7.4" / 187mm Diameter
ZUR6.5IC	100 WATTS	8-Ohms / 6-Ohms nom.	8.75" / 222mm Diameter
ZUR6.5IC DM	100 WATTS	4+4-Ohms / 3+3-Ohms nom.	8.75" / 222mm Diameter
ZUR5.25IW	80 WATTS	8-Ohms / 6-Ohms nom.	W: 7.26" / 184.5mm x L: 9.54" / 243mm
ZUR6.5IW	100 WATTS	8-Ohms / 6-Ohms nom.	W: 8.76" / 222.5mm x L: 11.1" / 282mm

FEATURES SUBJECT TO CHANGE WITH OUT NOTICE

5-Year Limited Warranty

Domestic Warranty (U.S.A. AND CANADA ONLY)

The MB Quart Home Audio Speaker warranty for In-Wall and In-Ceiling Speakers is valid only for consumers in the United States or Canada.

MB QUART, Maxxsonics Europe GmHb ("MB QUART") warrants this product to be free from defects in workmanship and materials (subject to the below terms) for a period of (five) 5-years from the date of original purchase to the original purchaser. During the Warranty period, MB QUART will repair or replace (at MB QUART's sole option) this product or any defective parts. To obtain Warranty service, please contact the MB QUART authorized dealer from which you purchased this product. If your authorized MB Quart Dealer is not equipped to perform the repair of your MB QUART product, it can be returned, freight paid, to MB QUART for repair. Please call MB QUART at (847-540-7700) for instructions. Only ship this product in its original packaging or packaging with an equal degree of protection. All damages resulting from insufficient packing are the sole responsibility of the products owner.

Proof of purchase in the form of a Bill Of Sale or receipted invoice, issued by an authorized MB Quart dealer is always required for any and all warranty related services.

This receipt and or Bill of Sale which is evidence that this genuine MB Quart product is within the manufacturer's warranty period. Said evidence must be presented or included to obtain any warranty service. This warranty is invalidated when and if the factory-applied serial number has been altered or removed from this product or this product was not purchased from a MB QUART authorized dealer.

Call Maxxsonics at 847-540-7700 to confirm your purchase was from an MB QUART authorized dealer. Be prepared to supply the unaltered serial number when requested. Return instructions and a coded Return Authorization number will be given to the purchaser. Following these steps prior to returning a product to MB Quart for warranty prevents your package from being refused upon delivery.

Valid only to the original purchaser, this warranty automatically terminates before expiration if the product is sold or otherwise transferred to another party.

This warranty does not cover product sold AS IS or when sold WITH ALL FAULTS. This warranty does not cover abuse, damage, cosmetic damage or damage due to misuse, accidents, negligence, Acts of God, Commercial Use, or modification of, or to any part of the product. This warranty does not cover damage due to improper operation, maintenance or installation, or attempted repair by anyone other than MB QUART or a MB QUART dealer which is authorized to do MB QUART warranty work. Unauthorized repairs void this warranty.

THE EXCLUSIVE REMEDY OF THE CONSUMER PROVIDED UNDER THIS WARRANTY IS REPAIRS OR REPLACEMENTS OF PRODUCT.

MB QUART SHALL NOT BE LIABLE FOR ANY INCIDENTAL OR CONSEQUENTIAL DAMAGES FOR BREACH OF ANY EXPRESS OR IMPLIED WARRANTY ON THIS PRODUCT. EXCEPT TO THE EXTENT PROHIBITED BY LAW.

THIS WARRANTY IS EXCLUSIVE AND IN LIEU OF ALL OTHER IMPLIED AND EXPRESS WARRANTIES WHATSOEVER, INCLUDING BUT NOT LIMITED TO, THE WARRANTY OF FITNESS AND MERCHANTABILITY FOR A PRACTICAL PURPOSE.

Some states do not allow the exclusion or limitation of incidental or consequential damages or implied warranties so the above exclusions may not apply to you. This warranty gives you specific legal rights, and you may have other rights, which vary from state to state.

WARRANTY OUTSIDE THE UNITED STATES & CANADA.

The warranty on this product if it is sold to a consumer outside of the United States or Canada shall comply with applicable law and shall be the sole responsibility of the distributor that supplied this product. To obtain any applicable warranty service, please contact the dealer from which you purchased this product, or the distributor that supplied this product. Products purchased outside the United States are not to be returned to any Maxxsonics Dealer or Maxxsonics facility within the United States under any circumstances.

MBQUART

German Engineering

MAXXSONICS USA, INC.
1290 Ensell Road
Lake Zurich, Illinois 60047 USA
Phone +1 847 - 540 - 7700
FAXX +1 847 - 540 - 9776
E-Mail info@maxxsonics.com
Website www.maxxsonics.com

MAXXSONICS EUROPE GMBH
Neckarstraße 20
74847 Obrigheim, Germany
Phone +49 (0) 62 61 - 6 38-0
FAXX +49 (0) 62 61 - 6 38-129
E-Mail info@mbquart.de
Website www.mbquart.de



Free Manuals Download Website

<http://myh66.com>

<http://usermanuals.us>

<http://www.somanuals.com>

<http://www.4manuals.cc>

<http://www.manual-lib.com>

<http://www.404manual.com>

<http://www.luxmanual.com>

<http://aubethermostatmanual.com>

Golf course search by state

<http://golfingnear.com>

Email search by domain

<http://emailbydomain.com>

Auto manuals search

<http://auto.somanuals.com>

TV manuals search

<http://tv.somanuals.com>