

USER'S GUIDE

TABLE OF CONTENTS

Welcome	Inside Cover
Safety Instructions.....	1-2
Washer Controls At A Glance.....	3-4
Washer Special Features	5
Washer Operating Tips	6
Dryer Controls At A Glance	7-8
Dryer Operating Tips.....	8
Dryer Exhaust Tips	9
Care and Cleaning	10
Storage.....	10
Before You Call.....	11-13
Water Use	13
Warranty.....	Back Page

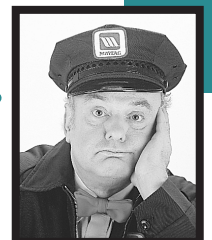
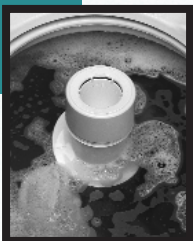

Model: LS7806

Welcome

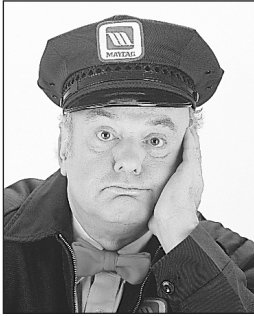

Welcome and congratulations on your purchase of a Consumer Rated No.1 Maytag Stacked Washer and Dryer! Your complete satisfaction is very important to us.

Read this manual for best results. It contains instructions to acquaint you with proper operating and maintenance procedures.

In addition you will find a *Laundering Tips* guide packed with your washer. It contains information on recommended laundering procedures, stain removal and special laundering situations.



Save time and money. If something should go wrong, we suggest consulting the “Before You Call” section in the back of this book. It is designed to help you solve basic problems before consulting a servicer.

However, should you need assistance in the future, it is helpful to:

1) Have complete model and serial number identification of your stacked washer and dryer. This is located on a data plate on the lower right corner of the door opening. Record these numbers below for easy access.

Model Number

Serial Number

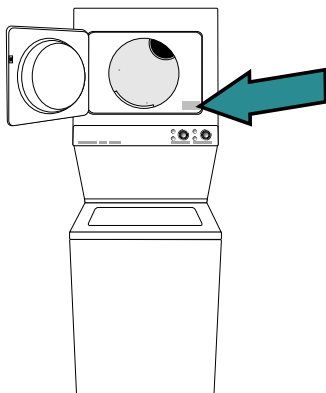

2) Have proof of original date of purchase.

Please attach your sales receipt here. Keep this information for your records (should you ever need warranty service).



For additional questions, please contact us:

Maytag Appliances Sales Company
Attn: CAIRSM Center
P.O. Box 2370
Cleveland, TN 37320-2370
1-800-688-9900 USA
1-800-688-2002 CANADA
1-800-688-2080 TTY USA
(Mon.–Fri., 8am–8pm Eastern Time)
Internet: <http://www.maytag.com>

NOTE: In our continuing effort to improve the quality of our appliances, it may be necessary to make changes to the appliance without revising this guide.

Important Safety Notice and Instructions.....

The California Safe Drinking Water and Toxic Enforcement Act of 1986 (Proposition 65) requires the Governor of California to publish a list of substances known to the State of California to cause cancer or reproductive harm, and requires businesses to warn customers of potential exposures to such substances.

Users of this appliance are hereby warned that the burning of gas can result in low-level exposure to some of the listed substances, including benzene, formaldehyde and soot, due primarily to the incomplete combustion of natural gas or liquid petroleum (LP) fuels. Exhaust ducts should be kept free of obstructions and properly exhausted dryers will minimize exposure.

Appliances with the  symbol on the data plate have been listed with Underwriters' Laboratories, Inc. Those with a CSA Monogram on the data plate have been certified by the CSA Testing Laboratories as complying with Canadian Standards Association requirements. Gas dryers with an AGA symbol on the data plate have been design certified with the American Gas Association; those with a CGA symbol on the data plate have been approved by the Canadian Gas Association. Nevertheless, as with any equipment using electricity and having moving parts, there are potential hazards. To use this appliance safely, the operator should become familiar with the instructions for operation of the appliance and always exercise care when using it.

 **WARNING** — For your safety the information in this manual must be followed to minimize the risk of fire or explosion or to prevent property damage, personal injury or death.

- Do not store or use gasoline or other flammable vapors and liquids in the vicinity of this or any other appliance.
- **WHAT TO DO IF YOU SMELL GAS**
 - Do not try to light any appliance.
 - Do not touch any electrical switch; do not use any phone in your building.
 - Clear the room, building or area of all occupants.
 - Immediately call your gas supplier from a neighbor's phone. Follow the gas supplier's instructions.
 - If you cannot reach your gas supplier, call the fire department.

Installation and service must be performed by a qualified installer, service agency or the gas supplier.

 **WARNING** — Do not place into your dryer items that have been spotted or soaked with vegetable oil or cooking oil. Even after being washed, these items may contain significant amounts of these oils. The remaining oil can ignite spontaneously. The potential for spontaneous ignition increases when the items containing vegetable oil or cooking oil are exposed to heat. Heat sources, such as your clothes dryer, can warm these items, allowing an oxidation reaction in the oil to occur. Oxidation creates heat. If this heat cannot escape, the items can become hot enough to catch fire. Piling, stacking or storing these kinds of items may prevent heat from escaping and can create a fire hazard.

All washed and unwashed fabrics that contain vegetable oil or cooking oil can be dangerous. Washing these items in hot water with extra detergent will reduce, but will not eliminate, the hazard. Always use the "cool down" cycle for these items to reduce the items' temperature. Never remove these items from the clothes dryer hot or interrupt the drying cycle until the items have run through the "cool down" cycle. Never pile or stack these items when they are hot.

Save These Instructions

Important Safety Instructions

⚠ WARNING — To reduce the risk of fire, explosion, electric shock, property damage or injury to persons when using your appliance, follow basic precautions, including the following:

1. Read all instructions before using the appliance.
2. To avoid the possibility of fire or explosion:
 - a. Do not wash or dry items that have been previously cleaned in, washed in, soaked in, or spotted with gasoline, dry-cleaning solvents, other flammable or explosive substances as they give off vapors that could ignite or explode. Hand wash and line dry any items containing these substances.

Any material on which you have used a cleaning solvent, or which is saturated with flammable liquids or solids, should not be placed in the appliance until all traces of these liquids or solids and their fumes have been removed.

These items include acetone, denatured alcohol, gasoline, kerosene, some liquid household cleaners, some spot removers, turpentine, waxes and wax removers.
 - b. Do not add gasoline, dry-cleaning solvents, or other flammable or explosive substances to the wash water. These substances give off vapors that could ignite or explode.
 - c. Under certain conditions, hydrogen gas may be produced in a hot water system that has not been used for 2 weeks or more. **HYDROGEN GAS IS EXPLOSIVE.** If the hot water system has not been used for such a period, before using a washing machine or combination washer-dryer, turn on all hot water faucets and let the water flow from each for several minutes. This will release any accumulated hydrogen gas. As the gas is flammable, do not smoke or use an open flame during this time.
 - d. Items containing foam rubber (may be labeled latex foam) or similarly textured rubber-like materials must not be dried on a heat setting. Foam rubber materials when heated, can under certain circumstances produce fire by spontaneous combustion.
 - e. Do not wash or dry items that are soiled with vegetable or cooking oil. These items may contain some oil after laundering. Due to the remaining oil, the fabric may smoke or catch fire by itself.
3. Do not allow children to play on or in the appliance. Close supervision of children is necessary when the appliance is used near children.
4. Before the appliance is removed from service or discarded, remove the door to the clothes washer compartment.
5. Do not reach into the appliance if the tub, agitator, or drum is moving.
6. Do not install or store this appliance where it will be exposed to the weather.
7. Do not tamper with controls.
8. Do not repair or replace any part of the appliance or attempt any servicing unless specifically recommended in published user-repair instructions that you understand and have the skills to carry out.
9. The agitator should not be removed. If the agitator is removed, it must be replaced by pushing down completely and the locking screw tightened before the washer is operated.
10. Do not use fabric softeners or products to eliminate static unless recommended by the manufacturer of the fabric softener or product.
11. Clean the dryer lint screen before or after each load.
12. Keep the area around the exhaust opening and surrounding areas free from lint accumulation, dust and dirt.
13. The interior of the dryer and exhaust duct should be cleaned periodically by qualified service personnel.
14. This appliance must be properly grounded. Never plug the appliance cord into a receptacle which is not grounded adequately and in accordance with local and national codes. See Installation Instructions for grounding this appliance.
15. Unplug power supply cord before attempting to service your appliance.
16. Store laundry aids and other material in a cool, dry place where children cannot reach them.
17. Do not use chlorine bleach and ammonia or acids (such as vinegar or rust remover) in the same wash. Hazardous fumes can form.
18. Do not machine wash fiberglass materials. Small particles can stick to fabrics washed in following loads and cause skin irritation.
19. Before the appliance is removed from service or discarded, remove the door to the clothes dryer compartment.
20. Install and level washer on a floor that can support the weight.
21. As with any equipment using electricity and having moving parts, there are potential hazards. To use this appliance safely, the operator should become familiar with the instructions for operation of the appliance and always exercise care when using it.

Save These Instructions

Washer Controls At A Glance

Step 1 Select Cycle

Press the control knob in and turn clockwise to the desired cycle. Pull the control knob out to start the washer.

PERMANENT PRESS is designed to minimize wrinkles with a cool-down spray rinse following the wash. Times available are:

- 14 minutes** – Use for heavily soiled or stained clothes.
- 10 minutes** – Use for normally soiled clothes.
- 6 minutes** – Use for lightly soiled clothes.

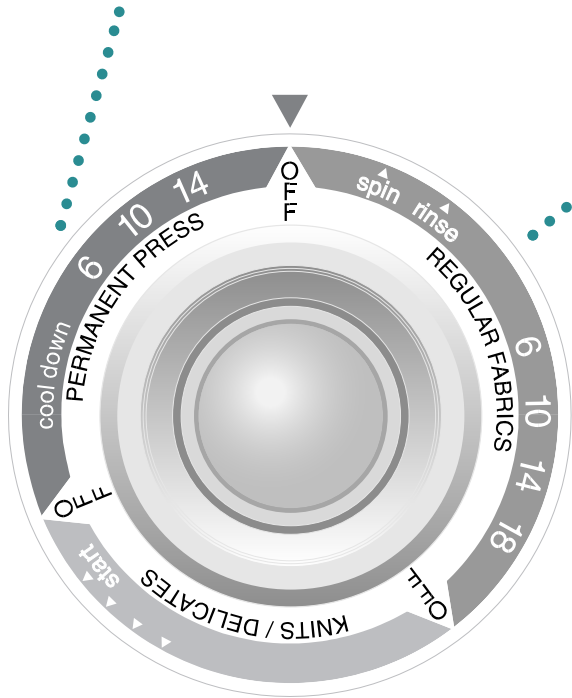

REGULAR FABRICS is used for normal, sturdy fabrics. Times available are:

- 18 minutes** – Use for very heavily soiled or stained clothes
- 14 minutes** – Use for heavily soiled or stained clothes.
- 10 minutes** – Use for normally soiled clothes.
- 6 minutes** – Use for lightly soiled clothes.

KNITS/DELICATES is designed for items requiring delicate wash action. It provides alternating periods of wash and soak for approximately 10 minutes.

The controls for the stacked washer and dryer are convenient and easy to use. The washer and dryer can operate at the same time or independently of each other.

Step 2 Select Load Size

Turn the **LOAD SIZE** knob to the **SMALL**, **MEDIUM**, or **LARGE** setting.

For best washing results, clothes must circulate freely. If too little water is used, poor cleaning, linting, and excessive wear may result.

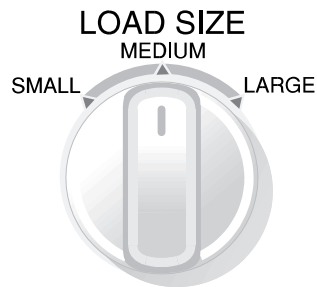

NOTE: When laundering permanent press items, delicates, washable woolen or loosely knit items, never use less than the **MEDIUM** setting. This will minimize shrinkage, wrinkling, and pulling of seams.

WATER LEVEL SETTING	LOAD SIZE
Large	3/4 – Full
Medium	1/2 – 3/4 Full
Small	1/3 Full

REMEMBER: Items must circulate freely for best results.

Step 3 Select Water Temperature

Turn the **TEMPERATURE** knob to the desired water temperatures. Follow the garment care label for best results. Use the chart to the right as a guide.

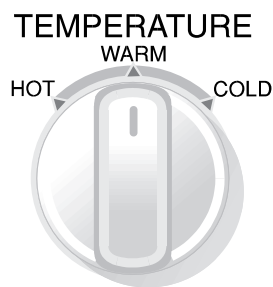

REMEMBER: In wash water temperatures below 65° F, detergents do not dissolve well or clean well. Care labels define cold water as up to 85° F.

WASH/RINSE TEMPS	LOAD TYPE
Hot/Cold	White and heavily soiled, color-fast items
Warm/Cold	Moderately soiled, colored items; most permanent press items
Cold/Cold	Brightly colored, lightly soiled items; washable woolens

Step 4 Start Washer

- Add detergent.
- Add laundry load and close lid.
- Pull out control knob to start.

NOTE: The washer is automatically programmed to assure proper agitation and spinning for each load type. **REGULAR FABRICS** will provide a fast wash/spin speed. **PERMANENT PRESS** will have a fast wash/spin speed along with a cool-down spray rinse. **KNITS/DELICATES** will have alternating periods of wash and soak and fast final spin speed.



Washer Special Features

Lift the Lid

The washer lid lifts up and down to open and close. Internal springs will hold the lid in the open position until pulled down to close.

This washer is designed so that it will not fill, agitate or spin when the lid is open. Should the lid be opened during a cycle, the washer will stop; when the lid is closed and the control knob is pulled out, the washer will resume its cycle at the point it was interrupted.

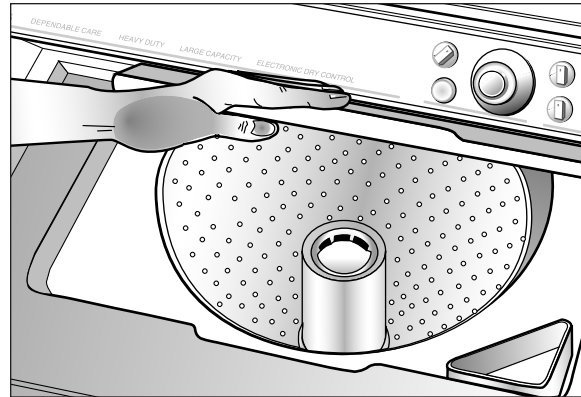

Bleach Dispenser

The dispenser automatically dilutes liquid chlorine bleach before it reaches your wash load. To use, follow these steps:

1. Measure liquid chlorine bleach carefully, following the instructions on the bottle.
2. Add the bleach to the dispenser before adding the load. Avoid splashing or over-filling the dispenser.

NOTE:

- Never pour undiluted liquid chlorine bleach directly onto the load or into the wash tub. It is a powerful chemical and can cause fabric damage, such as tearing or color loss, if not used properly.
- If you prefer to use color-safe, non-chlorine bleach, pour it into the wash tub with your detergent. Do not pour non-chlorine bleaches into the bleach dispenser.

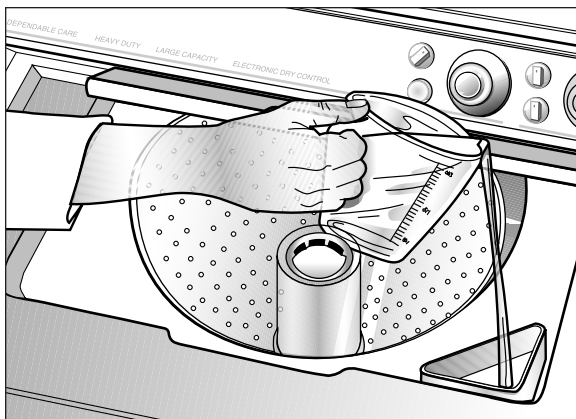

Pour liquid chlorine bleach into the bleach dispenser.

Fabric Softener Dispenser

This dispenser automatically releases liquid fabric softener at the proper time during the cycle. To use, follow these steps:

1. Pour liquid fabric softener into the dispenser using the amount recommended on the package.
2. Add warm water to the dispenser until it reaches the FILL LINE.

NOTE:

- Do not stop the washer during the first spin. This will cause the dispenser to empty too soon.
- Never pour fabric softener directly on the load. It will leave spots and stains.
- Use the dispenser for liquid fabric softeners only. Clean the area in and around the dispenser frequently with hot water, detergent and a soft brush.

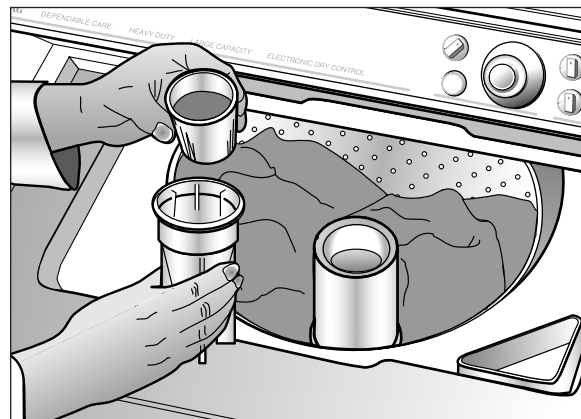

Pour liquid fabric softener into cup and dilute with warm water.



Washer Operating Tips

For detailed information on sorting, pretreating stains, etc., see the enclosed Laundering Tips pamphlet.

Detergent

- Use either liquid or granular laundry detergent. **For best results, be sure detergent is added to the washer BEFORE the load and be sure wash water is above 65° F.**
- Use the correct amount of detergent for the load size, soil level and water conditions. Use more detergent if you have hard water and very soiled loads.
If you have soft water or a lightly soiled load, use less detergent. (See manufacturer's instructions.)
- Wipe up any detergent spills on the washer.

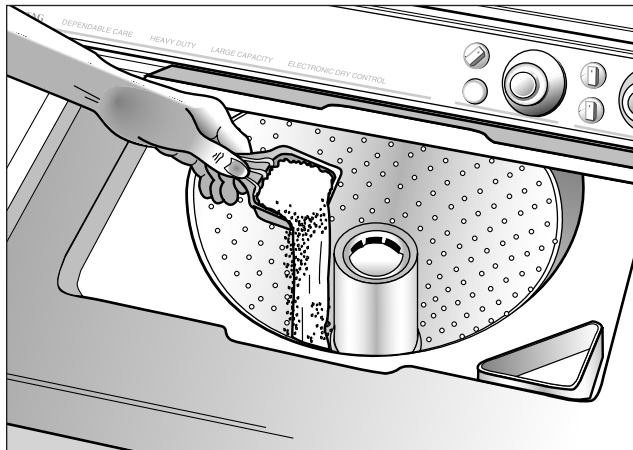

Loading

- Put dry, unfolded clothes loosely in the tub, up to the top row of holes for a maximum load.
- Do not wrap large items like sheets around the agitator.
- Mix large and small items for best circulation. Wash bulky items like blankets separately.
- When laundering permanent press items or items of delicate construction, washable woollens or loosely knit items, never use less than the **MEDIUM** water level setting. This will minimize shrinkage, wrinkling and pulling of seams.
- For best results, add the detergent to the washtub before adding the load.

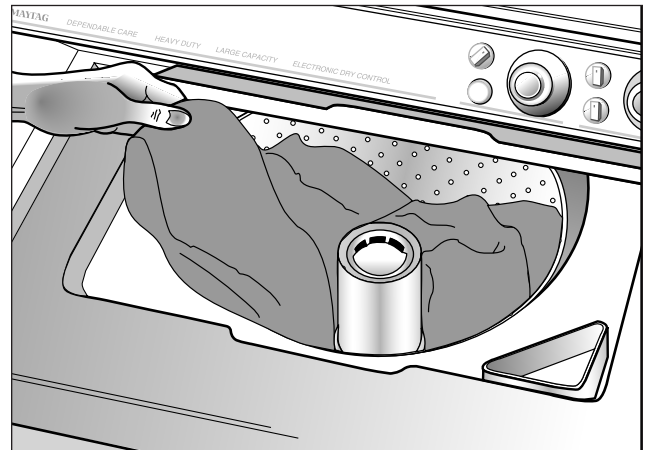

Additional Tips

- If the washer stops during the spin, it may be due to an unevenly distributed load. If this happens, push in the control knob, open the lid, redistribute the load, close the lid and pull out the control knob. The spin will resume at the point it was interrupted.
- The washer will pause briefly throughout each cycle. These pauses are normal.
- This washer is designed so that it will not fill, agitate or spin when the lid is open.
- If you open the lid during a cycle, the washer will stop. When the lid is closed and the control knob pulled out, the washer will continue the cycle at the point it was interrupted.

Dryer Controls At A Glance

Step 1 Select Cycle

WRINKLE RELEASE will release wrinkles from items that are clean and dry but slightly wrinkled. This cycle is for clothes from a crowded closet or suitcase or from sitting in the dryer too long after the end of the cycle. It provides 10 minutes of heated tumbling and 5 minutes of cool-down tumbling without heat. Press the START button for the cycle to begin.

DAMP DRY is designed to “partially” dry items. It provides approximately 20 minutes of heated tumbling and 5 minutes of cool-down tumbling without heat. Press the START button to begin tumbling.

TIME DRY may be selected for any load if the *IntelliDry* sensor system is not desired. Set the control to the desired number of minutes and choose the appropriate drying temperature for the load. Then press the START button.

AIR FLUFF provides tumbling without heat for sensitive loads or items needing freshening. Examples are: certain sweaters, shower curtains, camping gear, pillows, etc. Set the control to the desired number of minutes, up to 20 minutes, and press the START button.

IntelliDry **REGULAR FABRICS** automatically senses the moisture in the load and shuts off when the selected dryness level is reached. This cycle is designed for loads such as towels, underwear, t-shirts, jeans, etc. Set the control to the desired dryness level (more dry – less dry) and press the START button. The middle ▲ is the initial preferred setting for the majority of loads.

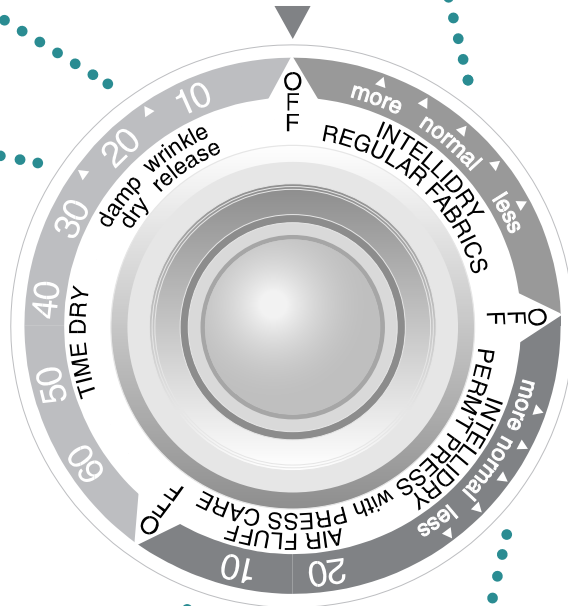

IntelliDry **PERM'T PRESS with Press Care** automatically senses the moisture in the load and shuts off when the selected dryness level is reached. Permanent Press minimizes wrinkles of man-made fabrics such as acrylic, nylon, polyester, or blends with an extended cool-down by tumbling the load in unheated air at the end of the cycle. Simply set the control to the desired dryness level (more dry – less dry) and press the START button. The middle ▲ is the initial preferred setting for the majority of loads.

Step 2 Select Temperature

Turn the **TEMPERATURE** selection knob to the appropriate drying temperature. The choices are:

REGULAR – for sturdy cottons or those labeled “Tumble Dry”.

DELICATE – for heat sensitive items labeled “Tumble Dry Low” or “Tumble Dry Warm”.

TEMPERATURE

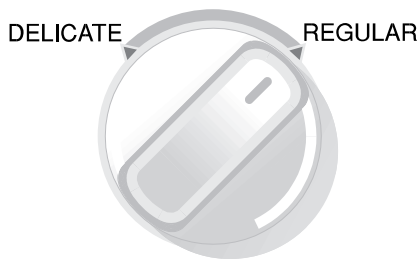

Step 3 Press Start

Push this button to start the dryer. The dryer door must be shut for the dryer to operate. If the door is opened during the cycle, the start button must be pushed again to resume the cycle once the door is closed.

When the cycle is complete, a signal will sound momentarily.

START

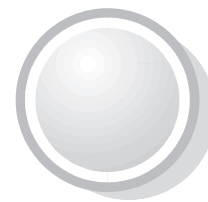

Dryer Operating Tips

Clean the Lint Filter...

- after each load.
- to shorten drying time.
- to operate more energy efficient.

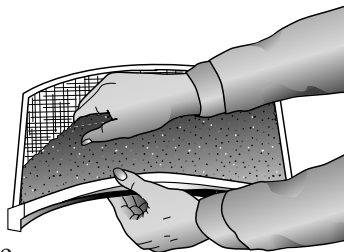

NOTE: Do not operate the dryer without the lint filter in place.

Add A Fabric Softener Sheet... (If So Desired)

- after loading the dryer.
- to control static cling.
- before the load becomes warm. This helps prevent greasy-looking softener stains.
- and remove any used softener sheets from the dryer to prevent greasy-looking softener stains.

Load the Dryer Properly...

- by placing only one washload in the dryer at a time.
- by avoiding very small loads or mixed loads.
- by adding one or more similar items to the dryer when only one or two articles need drying. This improves the tumbling action and drying efficiency.

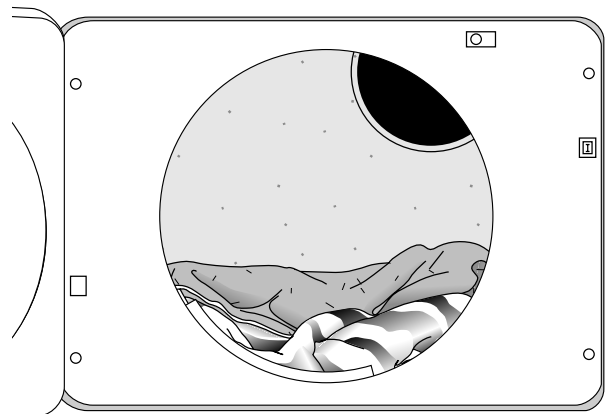

Dryer Exhaust Tips

⚠ WARNING — Plastic or nonmetal flexible duct presents a potential fire hazard.

Do

Read the installation instructions and the user's guide.

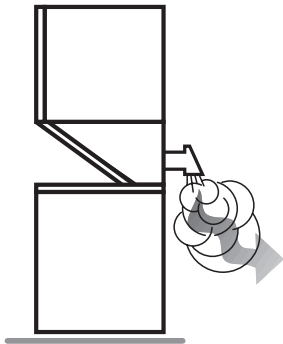

Do

Let your dryer exhaust the air easily.

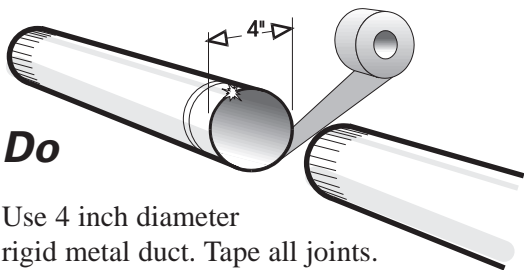

Do

Use 4 inch diameter rigid metal duct. Tape all joints. Never use lint-trapping screws.



Do

Keep duct runs as straight as possible.

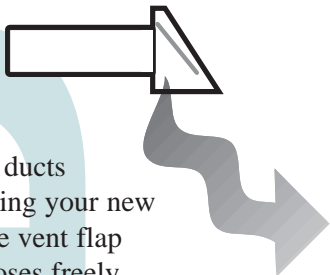

Do

Clean all old ducts before installing your new dryer. Be sure vent flap opens and closes freely.

Don't

Let a poor exhaust system cause slow drying.

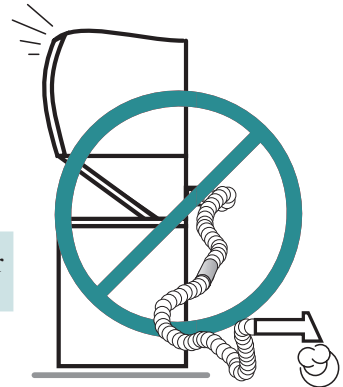

Don't

Restrict your dryer with a poor exhaust system.

Don't

Use plastic, thin foil, or non-metal flexible duct.

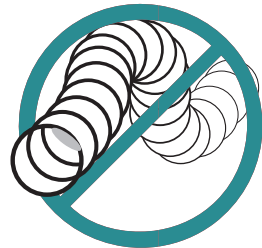

Don't

Use longer than necessary duct runs with many elbows.

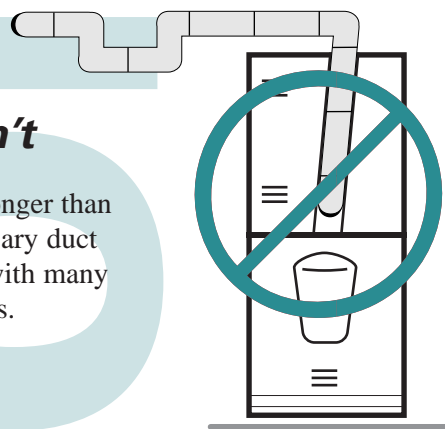

Don't

Allow crushed or clogged ducts and vent.

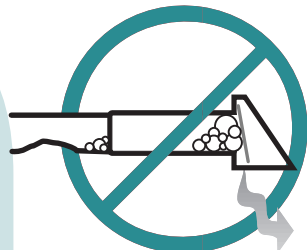



Care and Cleaning.....

Control Panel Care

Clean the control panel with a soft damp cloth. Do not use any abrasive powders or cleaning pads.

Cabinet Care

Simply wipe off any marks with soap and water, followed with an appliance wax if desired.

Washer Care

Lint Filter

The SELF-CLEAN LINT FILTER in the washer is located under the agitator and cleans itself. During the wash and rinse portion of the cycle, lint is collected on the filter. The filter is then flushed automatically during the spin and drain.

Interior

Hard water deposits may be removed, if needed, using a recommended cleaner labeled washer safe.

Dryer Care

Tumbler

If the tumbler becomes stained by a crayon, ink pen or other item inadvertently left in a garment, clean the tumbler with an all purpose cleaner such as: Fantastik, Soft Scrub or Formula 409®.* Then tumble old towels or rags to remove any excess stain or cleaning substance.

Exhaust System Cleaning

While the lint filter will catch most of the lint from the load, some will get through and may buildup in the ductwork. It is important to completely inspect and clean all lint accumulation from the interior of the ductwork once a year to maintain drying performance. The exhaust hood at the outside of the home should be cleaned more frequently to ensure the damper opens and closes freely.

Refer to the Installation Instructions for more details on proper exhausting.

**Brand names are trademarks of the respective manufacturers.*



Storing the Washer and Dryer.....

Washers can be damaged if water is not removed from hoses and internal components before storage. Prepare the washer and dryer for storage as follows:

- Select the Regular Fabrics cycle and add one cup of bleach or white vinegar to a full load of warm or hot water without clothes. Run the washer through a complete cycle.
- Turn the water faucets off and disconnect the inlet hoses.
- Advance the cycle control knob to the final spin of the Regular Fabrics cycle and lower drain hose to drain any water that may be in the drain hose.
- Disconnect the washer and dryer from the electrical supply and leave the washer lid open to let air circulate inside the tub.
- Clean the dryer tumbler with an all purpose cleaner such as Fantastik or Formula 409®* and disconnect from the power supply.

NOTE: For extended periods of storage or storage during extreme cold temperatures, call Maytag Customer Service in the U.S. at 1-800-688-9900 or in Canada at 1-800-688-2002.



Before You Call.....

For problem laundry solutions (i.e. fabric damage, residue, tangling) and special laundry care procedures, see the enclosed Laundering Tips pamphlet.

Check these points if your clothes washer...

Won't Fill

- Plug cord into live electrical outlet.
- Check fuse or reset circuit breaker.
- Close lid and pull control knob out to start the washer. For your safety, washer will not fill unless the lid is closed.
- Turn both faucets on fully.
- Straighten inlet hoses.
- Disconnect hoses and clean screens. Hose filter screens may be plugged.

Won't Agitate

- Check fuse or reset circuit breaker.
- Turn the control knob to proper cycle and pull knob out to start the washer.
- Close lid and pull control knob out to start the washer. For your safety, washer will not agitate or spin unless the lid is closed.

Won't Spin or Drain

- Unevenly distributed load. Redistribute the load, close the lid and pull knob out. Check for leveling. Be sure water level is acceptable for load size.
- Check fuse or reset circuit breaker.
- Straighten drain hoses. Eliminate kinked hoses. If there is a drain restriction, call for service.
- Close lid and pull control knob out to start the washer. For your safety, washer will not agitate or spin unless the lid is closed.
- Suds lock – caused by too much suds. Rewash without detergent. Use correct amount of a low-sudsing detergent.

(Continued on next page.)



Before You Call (continued).....

Check these points if your clothes washer...

Stops

- Unevenly distributed load. Redistribute the load, close the lid and pull knob out. Check for leveling. Be sure water level is acceptable for load size.
- Plug cord into live electrical outlet.
- Check fuse or reset circuit breaker.
- Turn the control knob to proper cycle and pull knob out to start the washer. If equipped with buttons, be sure they are fully depressed.
- Close lid and pull control knob out to start the washer. For your safety, washer will not fill, agitate or spin unless lid is closed.
- This may be a pause or soak period in the cycle. Wait briefly and it may start.

Leaks Water

- Make sure hose connections are tight.
- Make sure end of drain hose is correctly inserted and secured to drain facility.
- Avoid extended soaking – soak for 30 minutes or less.
- Avoid overloading.

Is Noisy

- Be sure washer is leveled properly as outlined in installation manual.
- Weak floors can cause vibration and walking.
- Be sure rubber feet are installed on leveling legs.

Fills with the Wrong Temperature Water

- Turn both faucets on fully.
- If equipped with a temperature selector knob, be sure it is set directly on a temperature setting and not between settings.
- Make sure temperature selection is correct.
- Make sure hoses are connected to correct faucets and inlet connections. Flush water line before filling washer.
- Check the water heater. It should be set to deliver a minimum 120°F (49°C) hot water at the tap. Also check water heater capacity and recovery rate.
- Disconnect hoses and clean screens. Hose filter screens may be plugged.

*For further assistance contact Maytag Appliances Sales Company, Maytag Customer Assistance:
 U.S. 1-800-688-9900 or Canada 1-800-688-2002
 U.S. customers using TTY for deaf, hearing impaired or speech impaired, call 1-800-688-2080.*



Before You Call (continued).....

Check these points if your clothes dryer...

Doesn't Run	<ul style="list-style-type: none"> • Be sure the door is latched shut. • Be sure the power cord is plugged into a live electrical outlet. • Check the home's circuit breaker and fuses. • Press the START button again if the door is opened during the cycle.
Doesn't Heat	<ul style="list-style-type: none"> • Check the home's circuit breaker and fuses. • Select a heat setting, not air-fluff. • On a gas dryer, check that the gas supply is on. • Clean the lint filter and exhaust duct.
Doesn't Dry	<ul style="list-style-type: none"> • Check all of the above, plus... • Be sure the exhaust hood at the outside of the home can open and close freely. • Use 4" rigid metal exhaust duct. • Do not overload. 1 Wash load = 1 Dryer load. • Sort heavy items from lightweight items. • Check that the washer is draining properly to extract adequate water from the load.
Is Noisy	<ul style="list-style-type: none"> • Check the load for objects such as coins, loose buttons, nails, etc. Remove promptly. • Be sure the dryer is leveled properly as outlined in the installation manual. • Be sure the rubber feet are installed on the leveling legs.
Control Knob Advances Slowly	<ul style="list-style-type: none"> • This is normal operation for an <i>IntelliDry</i> cycle, especially at the beginning of cycle. Once the load begins to dry, the control knob will start to advance. The rate of advancement will be slow at the beginning of the cycle because there is more moisture in the load. As the load becomes more dry, the control knob will advance more quickly.



Water Use

REGULAR OR DELICATE CYCLE

Large	Approx. 36 gallons (30 Imperial gallons; 136 liters)
Medium	Approx. 28 gallons (23 Imperial gallons; 106 liters)
Small	Approx. 22 gallons (18 Imperial gallons; 83 liters)

PERMANENT PRESS CYCLE

Large	Approx. 41 gallons (34 Imperial gallons; 155 liters)
Medium	Approx. 33 gallons (27 Imperial gallons; 125 liters)
Small	Approx. 26 gallons (22 Imperial gallons; 98 liters)



Full-size Stacked Washer & Dryer Warranty

Full One Year Warranty

For **one (1) year** from the date of original retail purchase, any part which fails in normal home use will be repaired or replaced free of charge.

Limited Parts Warranty

After the first year from the date of original retail purchase through the time periods listed below, the parts designated below which fail in normal home use will be repaired or replaced free of charge for the part itself, with the owner paying all other costs, including labor, mileage and transportation.

Second Year – All parts.

Third through Fifth Year – The washer drive motor. All parts of the solid state controls (if so equipped).

Third through Tenth Year – All parts of the washer transmission assembly.

Additional Limited Warranty Against Rust

Should any of the parts listed below rust during the one year period starting from the date of retail purchase, repair or replacement will be made free of charge. After the first and through the fifth year, repair or replacement will be made free of charge for the part itself, with the owner paying all other costs, including labor, mileage and transportation.

Automatic Washer: Exterior cabinet, top, lid and baseframe.

Dryer: Exterior cabinet, top, door, clothes tumbler, tumbler front, tumbler back and stand.

This full warranty and the limited warranties apply when the appliance is located in the United States or Canada. Appliances located elsewhere are covered by the limited warranties only, which include parts which fail during the first year.

To Receive Warranty Service

To locate an authorized service company in your area contact the Maytag dealer from whom your appliance was purchased; or call Maytag Appliances Sales Company, Maytag Customer Assistance at the number listed below. Should you not receive satisfactory warranty service, please call or write:

Maytag Appliances Sales Company
Attn: CAIRSM Center
P.O. Box 2370
Cleveland, TN 37320-2370

U.S. 1-800-688-9900

Canada 1-800-688-2002

U.S. customers using TTY for deaf, hearing impaired or speech impaired, call 1-800-688-2080.

When contacting Maytag Appliances Sales Company, Maytag Customer Assistance about a service problem, please include the following:

- (a) Your name, address and telephone number;
- (b) Model number and serial number (found on lower right corner of dryer door opening) of your appliance;
- (c) Name and address of your dealer and the date the appliance was purchased;
- (d) A clear description of the problem you are having.
- (e) Proof of purchase.

What is not covered by these warranties:

1. Conditions and damages resulting from any of the following:
 - a. Improper installation, delivery, or maintenance.
 - b. Any repair, modification, alteration or adjustment not authorized by the manufacturer or an authorized servicer.
 - c. Misuse, abuse, accidents, or unreasonable use.
 - d. Incorrect electric current, voltage or supply.
 - e. Improper setting of any control.
2. Warranties are void if the original serial numbers have been removed, altered, or cannot be readily determined.
3. Light bulb
4. Products purchased for commercial or industrial use.
5. The cost of service or service call to:
 - a. Correct installation errors.
 - b. Instruct the user on proper use of the product.
 - c. Transport the appliance to the servicer.
6. Consequential or incidental damages sustained by any person as a result of any breach of these warranties.

Some states do not allow the exclusion or limitation of consequential or incidental damages, so the above exclusion may not apply.

User's Guides, service manuals and parts catalogs are available from Maytag Appliances Sales Company, Maytag Customer Assistance.

MAYTAG • One Dependability Square • Newton, Iowa 50208

Free Manuals Download Website

<http://myh66.com>

<http://usermanuals.us>

<http://www.somanuals.com>

<http://www.4manuals.cc>

<http://www.manual-lib.com>

<http://www.404manual.com>

<http://www.luxmanual.com>

<http://aubethermostatmanual.com>

Golf course search by state

<http://golfingnear.com>

Email search by domain

<http://emailbydomain.com>

Auto manuals search

<http://auto.somanuals.com>

TV manuals search

<http://tv.somanuals.com>