



Washing machine

Instructions for use

MAF 1260



Introduction

Please read these instructions for use carefully and all other information enclosed with the washing machine.

Keep all documentation in a safe place for future reference or for any future owners.

Note: this machine is solely for domestic use.

Notes on disposal

All packaging material used is environmentally-friendly and recyclable. Please help dispose of the packaging via environmentally-friendly means.

Your supplier or local council will be able to give you details of current means of disposal.

Valuable materials can be salvaged from an old appliance via scrap reprocessing.

Note: pull out the mains plug from any old appliance. Cut the power cable and dispose of it, together with the plug.

When disposing of an old washing machine, please ensure that the door lock is rendered inoperable to prevent children shutting themselves in the appliance.

Contents

Page

Introduction	2
General delivery notes	4
Safety notes	4
Quick start	5
Description of controls	6
Programme Table	10
Programme selector	12
Detergent drawer	15
Detergents, washing aids and amounts to use	16
Useful advice for the user	18
The main wash	19
Cleaning and routine maintenance	21
Investigating malfunctions	23
Technical data	25
Setting up + installation	26

BEFORE SWITCHING ON THE APPLIANCE MAKE SURE IT IS CORRECTLY INSTALLED AND THAT THE TRANSIT BRACKETS ARE REMOVED AS SHOWN IN PAGE 26.

General delivery notes

Please check that the following items are delivered with the appliance:

- Instruction manual
- Warranty card
- Inlet hose

Check that no damage has occurred during transit, and if so, call your nearest Authorised Technical Support Service agent (see Customer Service)

Safety notes.

Note: for cleaning or maintenance of the washing machine

- A) Pull out the plug
- B) Turn off the tap
- C) **Maytag** equips all its appliances with earthing. Ensure that the mains supply is earthed, and if it is not, seek assistance from a qualified person.
- D) Do not touch the appliance when hands or feet are wet or damp. Do not use the appliance with bare feet.
- E) The use of adapters, multiple connectors and/or extensions is not recommended.

Note: water temperature can reach 90°C during the wash cycle

- F) Check there is no water left in the drum before opening the door.
- G) This appliance is not intended for use by young children or infirm persons unless they have been adequately supervised by a responsible person to ensure that they can use the appliance safely. Young children should be supervised to ensure that they do not play with the appliance.
- H) Do not pull the power cable or the appliance itself to remove the plug from the socket.
- I) The appliance must not be exposed to weather conditions (rain, direct sun, etc...)
- L) When moving the appliance never lift it by the controls or by the detergent drawer.
When in transit never rest the door against the trolley or transport the appliance without the polystyrene base.

M) **N.B!**

If the appliance is installed on a carpeted floor ensure that the ventilation holes on the base of the appliance are not obstructed.

- N) If the appliance is not running properly or breaks down, switch it off, turn off the tap and do not tamper with the appliance.

Consult only the Authorised Technical Support Service for possible repair and ask them to use original spare parts.

Failure to comply with the above can compromise the safety of the appliance.

- O) If the appliance's power cable should ever need replacing, consult the Authorised Technical Support Service

Quick start

Washing

- Open the door with the special DOOR HANDLE "A" (fig. 1, page 6)
- Select laundry and put it in the machine
- Close the door
- Put detergent in the compartments as indicated in the programme guide in this instruction manual
- Select programme
- After a few seconds the "END" indicator light will start to blink

Press additional function buttons (if required)

- Press the "Start/Pause" button (page 7)

After washing:

- Wait for the door lock to be released (about minutes after the programme has finished).
- Switch off the washing machine by turning the selector to "OFF".
- Open the door and remove the laundry

Description of controls

Fig. 1

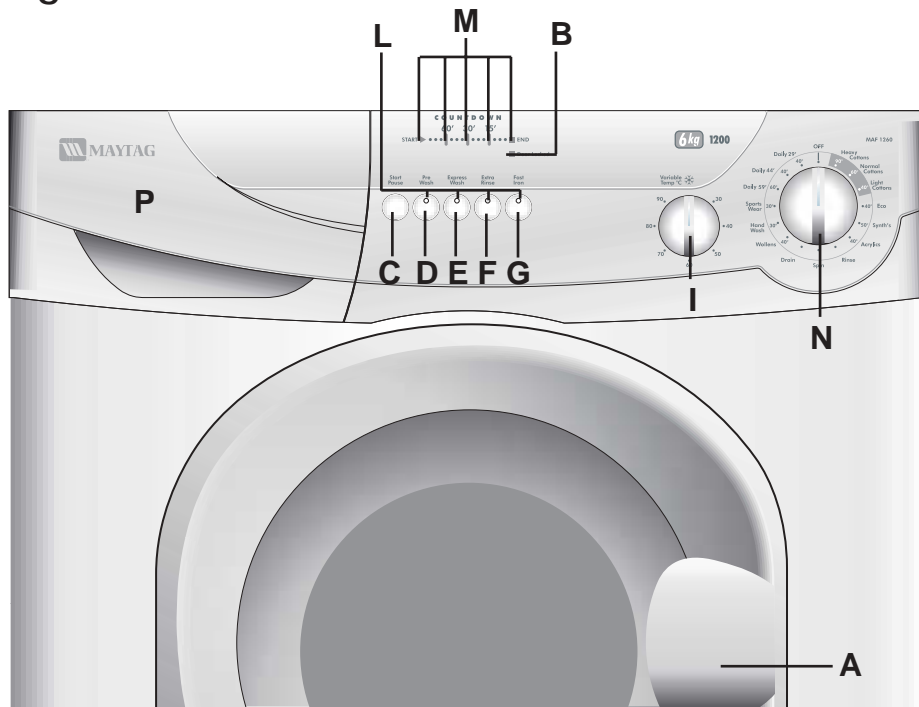

- Door handle A
- "Door Locked" indicator light B
- "Start/Pause" button C
- "Pre Wash" button D
- "Express Wash" button E
- "Extra Rinse" button F
- "Fast Iron" button G
- Wash control temperature knob I
- Buttons indicator light L
- Time countdown system indicator lights M
- Timer knob for wash programmes with "OFF" position N
- Detergent drawer P

Door handle A

Press the finger-bar inside the door handle to open the door.

DOOR LOCKED indicator light B

The "**Door Locked**" indicator light is illuminated when the door is fully closed and the machine is ON.
When the "**Start/Pause**" button is pressed on the machine with the door closed the indicator will flash momentarily and then illuminate.

If the door is not closed the indicator will continue to flash.

A special safety device prevents the door from being opened immediately after the end of the cycle. Wait for 2 minutes after the wash cycle has finished and the "**Door Locked**" light has gone out before opening the door. At the end of cycle turn the programme selector to "**OFF**".

START/PAUSE button C

When a programme is selected, wait for the "END" indicator light to flash before pressing the "Start/Pause" button.

Press to start the selected cycle (according to the selected cycle one indicator light will go on).

Note: When the "Start/Pause" button has been pressed, the appliance can take a few seconds before it starts working.

Changing the settings after the programme has started (PAUSE)

The programme may be paused at any time during the wash cycle by holding down the "**Start/Pause**" button for about two seconds. When the machine is in the paused mode, the "**COUNTDOWN**" indicator and option buttons will flash.

To restart the programme, press the "**Start/Pause**" button once again.

If you wish to add or remove items during washing, wait 2 minutes until the safety device unlocks the door.

When you have carried out the manoeuvre, close the door, press the "**Start/Pause**" button and the appliance will continue working where it left off.

CANCELLING THE PROGRAMME

To cancel the programme, the programme selector should be rotated to the "**OFF**" position.

The option buttons should be selected before pressing the "Start/Pause" button.

PRE WASH button

D

This option is particularly useful for heavily soiled loads and can be used only on some programmes as shown in the programmes table.

Detergent for this programme should be added to the first compartment of the soap drawer labelled "I" (please refer to Detergent Drawer Section of manual).

We recommend you use only 20% of the recommended quantities shown on the detergent pack. Fabric conditioner should not be used for this programme.

EXPRESS WASH button

E

Pressing this button reduces the time of the wash programme by a maximum of 50 minutes depending on the programme and the temperature selected. The Express Wash button can be used for washing loads of 1 to 6 kg. This option may only be utilised on cottons and synthetics programmes.

EXTRA RINSE button

F

Thanks to the new electronic system it is possible to effect a new special rinse cycle. The addition of more water and the new action combined of cycles of rotation of the drum with load and unloading of water allow the laundry to be perfectly rinsed. This function has been developed for people with delicate and sensitive skin, for which the least residue of detergent can cause irritations or allergies. It is advisable to use this function for children's items, for washing very dirty items and for washing of towels whose fibers mostly have the tendency to hold detergent.

This option is not available on **SPECIALS** programmes excluding the "Sports Wear" programme.

FAST IRON button

G

The "Fast Iron" function minimizes creases as much as possible with a uniquely designed anti-crease system that is tailored to specific fabrics.

MIXED FABRICS - the water is gradually cooled throughout the final two rinses with no spinning and then a delicate spin assures the maximum relaxation of the fabrics.

DELICATE FABRICS - final two rinses with no spinning and then the fabrics are left in water until it is time to unload. When you are ready to unload, press the "Fast Iron" button - this will drain the load.

WOOLLENS & HAND WASH - after the final rinse the fabrics are left in water until it is time to unload and the button indicator is blinking.

When you are ready to unload, press the "Fast Iron" button, this will drain and spin ready for emptying.

If you do not want to spin the clothes and activate drain only:

- ◆ turn the programme selector to the "OFF" position;
- ◆ select programme drain only;
- ◆ switch on the appliance again by pressing the "Start/Pause" button.

WASH TEMPERATURE selector

Can be turned in either direction

This washing machine is equipped with this device for setting the wash temperature you want. We recommend that the temperature shown on the label inside garments should never be exceeded.

The most suitable temperature and cycle for each type of fabric is shown in the programme guide.

To protect fabrics, if the variable temperature dial has accidentally been set too high than stated in the programme guide, the machine will lower the temperature automatically.

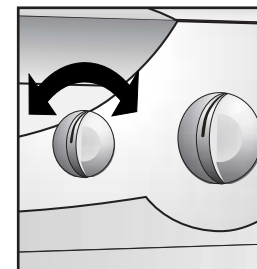

Buttons indicator light

L

The indicator light around the option buttons will light when specific options are selected.

Time countdown system indicator lights

M

In order to better manage your time, this washing machine features an indicator light system that keeps you constantly informed on the remaining cycle time.

Indicator light START :	remaining time above 60 minutes.
Indicator light 60' :	remaining time less than 60 minutes.
Indicator light 30' :	remaining time less than 30 minutes.
Indicator light 15' :	remaining time less than 15 minutes.
Indicator light END :	end of the programme.

PROGRAMME selector with OFF position

N

ROTATES IN BOTH DIRECTIONS.

The machine is turned on by selecting a programme via the programme selector. This status will be indicated by the "END" indicator light flashing. This light will continue to flash until the machine has started or the machine is returned to the "OFF" position.

The programme carries out with the programme selector stationary on the selected programme till cycle ends.

Switch off the washing machine by turning the selector to "OFF".

Note: the programme selector must be returned to the "OFF" position at the end of each cycle or when starting a subsequent wash cycle prior to the next programme being selected and started.

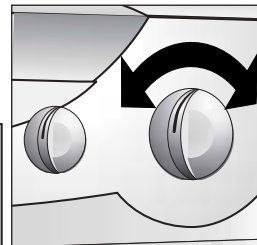
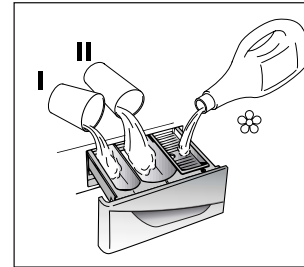

TABLE OF PROGRAMMES

PROGRAM FOR:	PROGRAMMES SELECTOR ON:	WEIGHT MAX kg	TEMP. °C	CHARGE DETERGENT			
				I	II	☼	
Resistant fabrics Cotton, linen	Heavy - 90° Cottons	6	Up to: 90°	(●)	●	●	
Cotton, mixed resistant	Normal - 60° Cottons	6	Up to: 60°	(●)	●	●	
Cotton	Light - 40° Cottons	6	Up to: 40°	(●)	●	●	
Resistant fabrics	Eco - 40°	6	Up to: 40°		●	●	
Mixed fabrics and synthetics Mixed, resistant	Synth's - 50°	2	Up to: 50°	(●)	●	●	
Very delicate fabrics	Acrylics - 40°	2	Up to: 40°		●	●	
	RINSE	Rinse	-	-		●	
	SPIN	Spin	-	-			
	DRAIN ONLY	Drain	-	-			
Specials	WOOLLENS	Woolleens - 40°	1	Up to: 40°		●	●
	SILK – HAND WASH	Hand - 30° Wash	1	Up to: 30°		●	●
	MIXED FABRICS	Sports - 30° Wear	2,5	Up to: 30°	●	●	●
	RESISTANT FABRICS	Daily 59' - 60°	3	Up to: 60°		●	●
	RESISTANT or MIXED FABRICS	Daily 44' - 40°	3,5	Up to: 40°		●	●
	RESISTANT or MIXED FABRICS	Daily 29' - 40°	2	Up to: 40°		●	●



Please read these notes

When washing heavily soiled laundry it is recommended the load is reduced to 3 kg maximum.

(●) Only with the Prewash button selected. (Programmes with Prewash button available)

■ The variable temperature selector allows a reduction in the wash temperature in each programme.

ATTENTION: With the temperature selector on the ☼ position the programme will be performed with a cold wash.

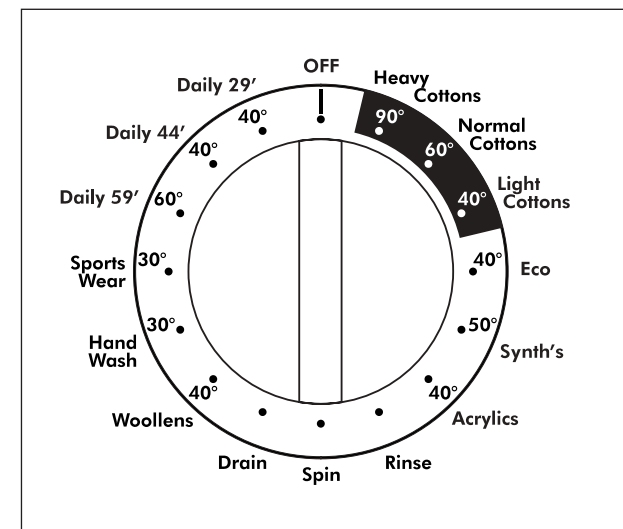

Programme selector

For the various types of fabrics and various degrees of dirt the washing machine has different programme bands according to: wash cycle, temperature and length of cycle (see table of washing cycle programmes).

RESISTANTS FABRICS

The programmes have been designed for a maximum wash and the rinses, with spin intervals, ensure perfect rinsing. The final spin gives more efficient removal of water.

SPECIAL "ECO" PROGRAMME

This special programme has been developed to allow you to obtain the best washing performance, even at full load, as the 60°C Cotton programme (the normal cycle) but with the advantage of an energy saving due to 40°C temperature, instead of 60°C.

MIXED AND SYNTHETIC FABRICS

The main wash and the rinse provides the best results due to the rotation rhythms of the drum and to the water levels. A gentle spin will mean that the fabrics become less creased.

SPECIAL DELICATE FIBRES

This is a new wash cycle which alternates washing and soaking and is particularly recommended for very delicate fabrics. The wash cycle and rinses are carried out with high water levels to ensure best results.

SPECIAL "RINSE" PROGRAMME

This programme carries out three rinses with a spin at 800 rpm. It can be used for rinsing any type of fabric, eg. use after hand-washing.

SPECIAL "SPIN" PROGRAMME

Programme "SPIN" carries out a spin at 800 rpm.

DRAIN ONLY

This programme drains out the water.

WOOLLENS PROGRAMME

A programme dedicated to washing woollen fabrics. The cycle comprises of alternate periods of activity and pauses. The programme has a maximum temperature of 40°C and concludes with 3 rinses and a short spin.

Heavy
Cottons

Normal
Cottons

Light
Cottons

Eco

Synth's

Acrylics

Rinse

Spin

Drain

Woollens

SPECIAL "HAND WASH" PROGRAMME

This washing machine also has a gentle Silk and Hand Wash programme cycle.

This programme allows a complete washing cycle for garments specified as "Hand Wash only" and laundry items made from Silk on the fabric label. The programme has a maximum temperature of 30°C and concludes with 2 rinses and no final spin.

SPORTS WEAR

The washing machine has a unique "Sports Wear" programme. It is specially designed to wash mixed sportswear fabrics that cannot be washed on hotter programmes and is designed to remove the soil and staining created by participation in sports activities. This programme starts with a cold prewash that breaks down and loosens any excess dirt and then washes at a cool 30°C, rinses and spins slowly for the best care of your heavily soiled, delicate garments.

DAILY WASH 59'

This specially designed programme maintains the high quality wash performance whilst greatly reducing the wash time. The programme is designed for a maximum load of 3 kg with a temperature of 60°C and concludes with 2 rinses and a high speed spin sequence.

DAILY WASH 40°C – FAST PROGRAMMES

By maintaining exceptional washing performance, these programmes allow you to know in advance the necessary time for your everyday laundry. In fact, this washing machine is equipped with 2 daily rapid programmes at 40°C, that were developed for lightly soiled fabrics and medium or little load.

DAILY WASH 40°C – FAST 44'

A complete washing cycle (wash, rinse and spin) able to wash in approximately 44 minutes:

- a maximum load of 3,5 kg;
- lightly soiled fabrics (cotton and mixed fabrics).

We recommend, with this programme, a 30% detergent loading dose (compared to the normal one) in order to avoid detergent waste.

DAILY WASH 40°C – FAST 29'

A complete washing cycle (wash, rinse and spin) able to wash in approximately 29 minutes:

- a maximum load of 2 kg;
- lightly soiled fabrics (cotton and mixed fabrics).

We recommend, with this programme, a 20% detergent loading dose (compared to the normal one) in order to avoid detergent waste.

Hand
Wash

Sports
Wear

Daily 59'

Daily 44'

Daily 29'

Automatic Variable Capacity

The washing machine is fitted with an automatic reduction in consumption system (known as Automatic Variable Capacity).

This system enables the machine to use the amount of water needed to wash and rinse the laundry in relation to the particular load.

This results in a reduction in the amount of water used and electricity needed to heat it to the minimum required, without in any way compromising the washing and rinsing performance.

In fact the amount of water and electricity used will always be appropriate for the amount of washing.

The washing machine therefore ensures you achieve excellent washing results whilst respecting the environment and saving you money.

Detergent drawer

P

The detergent draw is split into 3 compartments:

- the first, labelled "I", is for prewash detergent;
- the second, labelled "II", is for main wash detergent.

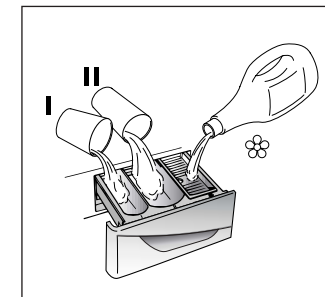

- the third, labelled "☼" is for special additives, fabric softeners, fragrances, starch, brighteners etc.

Note: only put liquid products in the third compartment.

The machine is programmed to automatically take up additives during the final rinse stage for all wash cycles.

Detergents, washing aids and amounts to use

Choice of detergent

General purpose detergents

- **Powder detergents**, for a thorough wash, with bleaching agent, particularly suitable for use in hot wash programmes (60°C and over), for heavily soiled and stained laundry.
- **Liquid detergents**, particularly suitable for grease stains, such as greasy skin marks, cosmetics and oil.
These detergents are not suitable for washing stained laundry, as they do not contain bleach.
- **Biological detergents**, not all the products available give a really thorough wash.

Special detergents

- **Detergents for coloureds and delicates**, without added bleach, also often without any optical brightening agents, to preserve the colour.
- **Detergents for a thorough wash**, without added bleach or enzymes, particularly suitable for handling woollen fibres.
- **Detergents for curtains** with optical brightening agents, resistant to light, to prevent yellowing from sunlight.
- **Special detergents** for programmed use of chemical substances, depending on fabric type, degree of soiling and water hardness.
Here basic detergents, softeners, bleaches/stain removers can be added separately.

Additional laundry aids

- **Water softener**, means less detergent can be used where water hardness is classed as hard to very hard.
- **Prewash substances**, for the programmed treatment of stains prior to the main wash.
Using them means the subsequent wash can be at a low temperature or with bleach-free detergents.
- **Fabric softener**, prevents static build-up in synthetic fabrics and softens fabrics.
If you own a tumble dryer, clothes are softened even without the use of a fabric softener.

Do not put solvents in the washing machine!

Keep detergents and other laundry products out of children's reach.

Before pouring in the detergent check that there are no foreign bodies in the detergent drawer.

Dosage details are usually shown on the detergent packaging. Follow those instructions.

Dosages

Only use detergents which are suitable for use in a washing machine.

You will obtain the best results from your wash with the minimum use of chemical products and the best care for your laundry if you take into consideration the degree of soiling as well as the type of detergent to choose.

The amount of detergent to use depends on:

- water hardness: depending on the hardness of the water and the type of detergent used, it is possible to reduce the amount of detergent.
- the degree of soiling: it is possible to reduce the amount of detergent used depending on the degree of soiling.
- amount of laundry: it is possible to reduce the amount of detergent when washing only a small amount of laundry.

Dosage for powder detergent

For normal and low concentration detergents: for normally soiled laundry choose a programme without prewash.

Put the detergent in compartment "II" of the drawer.

For heavily soiled laundry, choose a programme with prewash.

Put 1/4 of the detergent in compartment "I", 3/4 in compartment "II" of the drawer.

When using water softeners, first put in the detergent, then add the softener to compartment "II".

For highly concentrated detergents not in single dose format, follow what is shown on pack exactly as regards type and amount of dosage.

To avoid the difficulty of checking if the detergent has been taken up, use the dosage aids provided in the detergent packaging.

Liquid detergent dosage

Liquid detergents may be used in accordance with the instructions on the relevant packaging, for all programmes without prewash, by using the special container which is placed in the drum or, for those models that have it, in the special insert for liquid detergents.

Useful advice for users

Tips on using your domestic appliance in the most environmentally-friendly and economical way

Do a full load in your washing machine

To prevent any possible waste of energy, water or detergent we recommend that you put a full load in your washing machine, do not exceed the maximum loads shown below:

Cotton and linen	6	kg
Mixed	2	kg
Very delicate	2	kg
Wool	1,5	kg

Up to 50% energy saving can be made with one full load compared to two half load washes

When is prewashing really needed?

Only with particularly dirty loads!

Energy savings of 5 to 15% are made by not selecting the prewash option for normal soiled laundry.

Which wash temperature should you choose?

Using stain removers before machine washing reduces the need to wash at temperatures over 60°C.

Energy savings of up to 50% can be made by using a 60°C wash temperature rather than 90°C

Main wash

Sorting the laundry

- It is recommended you wash only items which are machine washable with water and detergent and not dry-clean items.
- If you need to wash rugs, bedspreads or other heavy items, it is best not to spin them.
- Sort the laundry according to fabric type, degree of soiling and wash temperature: Always follow the wash care advice on the garment label for the most suitable care and treatment of the laundry

Laundry for hot wash 

Coloured, easy-care materials   

Delicates and wool  

Wash by hand 

Items labelled with the following symbol are not suitable for machine washing:

Dry clean 

For very delicate items, such as net curtains, underwear, tights etc., you are advised to use a laundry net or wash bag.

- Woollen items must be labelled with the "Pure New Wool" symbol to be washed in the machine, and must also be labelled "non-matting" or "machine washable".
- Colour often leaks from new coloured items.

This can then colour other lighter items being washed.

We therefore recommend that coloured items should be washed for the first time separately.

For future washes, colourfast items can only be washed with whites up to 40°C.

Note: when sorting laundry

- check there are no metal objects in the laundry (such as paper clips, safety pins, pins, coins etc...);
- button up pillowcases, fasten zips, hook & eye fasteners, belts and long dressing gown cords;
- remove curtain hooks;
- pay close attention to the labels on items
- if you notice stubborn stains whilst sorting the laundry, remove them using a special detergent or a special stain remover.

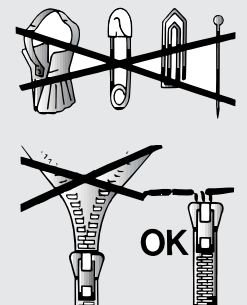

- We recommend that you do not do a full load of towelling items only as these become too heavy since they absorb a lot of water.

The correct way to wash

Preparing the laundry

A) Select the laundry.

Loading the laundry

B) Open the porthole.

C) Put the laundry in the washing machine.

Close the porthole again, ensuring that no items of laundry are obstructing the lock.

Putting detergent in machine

D) Open the drawer, choose the detergent and put in the correct amount, according to the manufacturer's instructions and the advice on page 16.

Add any other laundry aids (see page 16). Close the drawer again.

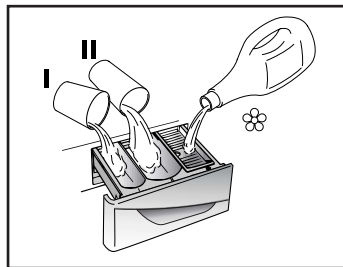

Selecting the wash programme

Refer to the programme guide to select the most suitable programme.

Activate the programme by turning the selector knob.

Wait for the "END" indicator light to flash.

Set the temperature using the temperature control knob.

Press additional function buttons (if required)

Check that the tap is turned on and that the discharge hose is positioned correctly.

Press the "Start/Pause" button.

When the "Start/Pause" button is pressed the machine sets the working sequence in motion.

The programme carries out with the programme selector stationary on the selected programme till cycle ends.

Warning: If there is any break in the power supply while the machine is operating, a special memory stores the selected programme and, when the power is restored, it continues where it left off.

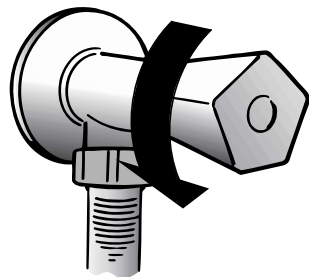

When the programme is finished

The indicator light "END" will go on.

Wait for the door lock to be released (about 2 minutes after the programme has finished).

Switch off the machine by turning the programme selector to the "OFF" position.

Open the door and remove the laundry. Turn off the tap.

Cleaning and routine maintenance

Do not use alcohol-based scourers and /or thinners on the outside of your washing machine, just a wipe with a damp cloth will suffice. The washing machine needs very little maintenance:

- Cleaning the drawer compartments.
- Cleaning the filter.

Cleaning the drawer compartments

Even if it is not strictly necessary, it is good to clean the compartments for detergents and additives occasionally.

- To do this you just need to pull them out firmly, but without forcing them.
- Clean everything in the compartment under running water.
- Put everything back in its proper place.

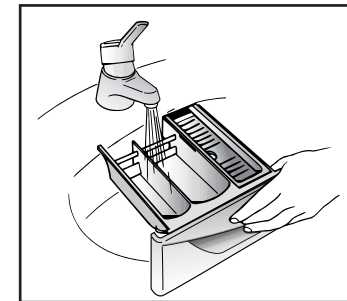

Cleaning the filter

The washing machine is fitted with a special filter for handling large deposits which could block the discharge hose (coins, buttons etc.) and which can, therefore, be easily retrieved.

We recommend that the filter be cleaned at least once a month.

The cleaning operation is as follows:

- Ease off the plinth cover as shown in picture.
- Use the base as a tray to collect leftover water in filter.
- Loosen the screw which holds the filter in place. Turn the filter anti-clockwise until it stops in the vertical position. Remove and clean.
- After cleaning, replace the filter and lock by tightening the filter screw. Then follow all procedures described above in reverse order.

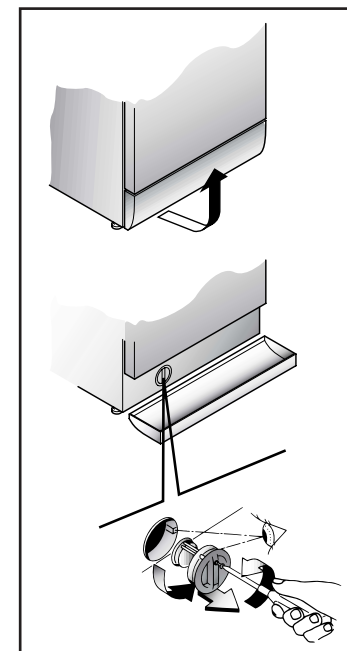

Attention: if the filter needs cleaning while there is washing still in the drum, follow the instructions on the following page to empty the water. This will prevent excessive loss of water via the filter.

Transporting the appliance or long periods when appliance is not in use

If the appliance is being transported or is out of use for long periods in unheated places, all remaining water must be completely removed from the hoses.

Ensure mains power is off, then unclip the hose and point it downwards into a basin until all the water has emptied out.

When finished, repeat the operation in the reverse order.

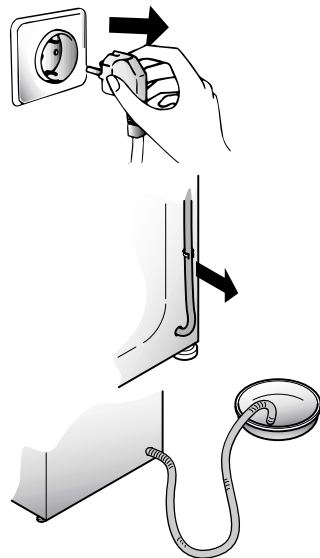

Investigating malfunctions

What might be the cause of...
Defects you can remedy yourself

MALFUNCTION	CAUSE	REMEDY
1. Does not work on any programme	Plug not in socket. Not switched on. Power failure. Fuse blown. Door open.	Plug it in. Switch on. Check. Check. Close door.
2. Does not fill with water	See cause 1. Tap turned off. Programme selector not correctly positioned.	Check. Turn on tap. Position programme selector correctly.
3. Water does not drain away	Kink in discharge hose. Foreign bodies in filter	Straighten discharge hose. Examine filter (see pages 21-22)
4. Water on floor around the washing machine	Leaking gasket between tap and water inlet hose.	Replace gasket and tighten hose and tap well.
5. Does not spin	Water has not yet drained away. "No spin" selected (certain models only).	Wait a few minutes for machine to empty. Reset button or turn "no spin" knob.
6. Machine vibrates a lot during spin	Washing machine not completely level. Transit brackets not removed yet. Load not distributed evenly.	Adjust the special adjustable feet. Remove transit brackets. Rearrange the laundry evenly.
7. Door will not open	Two minutes have not elapsed since the programme finished.	Wait two minutes.

The machine makes a different noise when spinning! This is because it has a manifold motor for better performance.

Only a small level of water can be seen in the drum! This is because new machines do not use much water, yet achieve the same standard of washing and rinsing.

Note:

The use of environmentally-friendly, phosphate-free detergents can have the following effects:

- waste water from rinsing may be cloudier because of the presence of zeolites held in suspension, without the rinse performance being adversely affected;
- presence of white powder (zeolites) on laundry after washing, which is not absorbed by the fabric and does not alter the colour of the fabric.
- The presence of foam in the final rinsing water is not necessarily an indication of poor rinsing.
- Anionic surfactants used in washing detergent formulae often prove to be difficult to remove from the laundry itself and, even in small quantities, can still cause considerable foam production.
- Carrying out more rinse cycles does not serve any purpose in such cases.

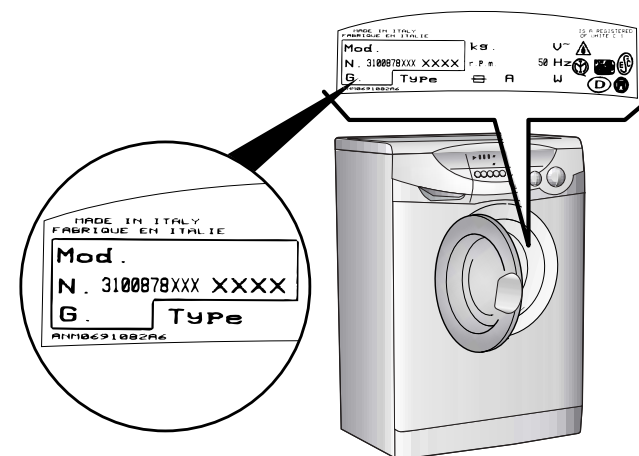

Fig. 2

Technical data

- Max. load of dry laundry
- Water pressure

6 kg

- Spin speed

0,05 ÷ 0,8 MPa
1200 rpm

Measurements

- Width
- Depth
- Height

60 cm
54 cm
85 cm

NB: For specifications regarding electrical data, see the data panel on the front of the washing machine (porthole area) - as shown in diagram above.

SETTING UP + INSTALLATION

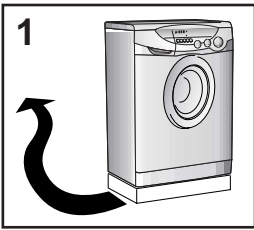

1 Remove the polystyrene base and place the machine near its permanent position (diagram 1).

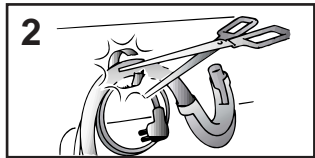

Carefully cut through the hose retaining clip at the rear of the appliance (diagram 2).

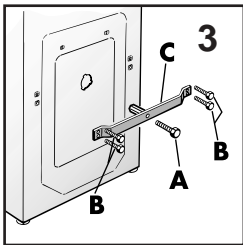

Unscrew the central bolt (A); unscrew the 4 lateral screws (B) and remove the cross piece (C) (diagram 3).

Lean the machine forward and remove the plastic bags containing the two polystyrene blocks at the sides, pulling downwards (diagram 4).

Press the plug (to be found in the envelope with the instructions) into the hole and rotate to lock into position (diagram 5).

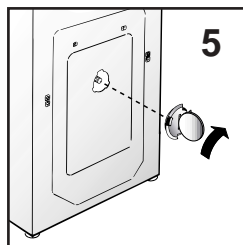
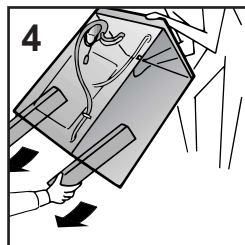

WARNING:
DO NOT LEAVE THE PACKAGING WITHIN REACH OF CHILDREN AS IT IS A POTENTIAL SOURCE OF DANGER.

Apply the insulation sheet of corrugated material to the base as shown.

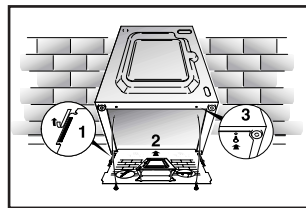

Level the machine by means of the front feet.

- Turn the nut clockwise to release the screw adjuster on the foot.
- Rotate the foot to raise or lower it until it stands firmly on the ground.
- Lock the foot in position by turning the nut anti-clockwise until it comes up against the bottom of the machine.

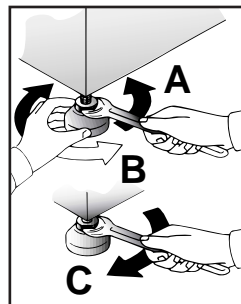

Note: we recommend you keep the transit bracket, braces and screws to immobilise the machine for future transit.

The Manufacturers will not be responsible for any possible damage to the machine caused by not following the rules relating to releasing the mechanism. The user is responsible for all costs of installation.

Water connection

The appliance must be connected to the water mains using new hose-sets. The old hose-sets should not be reused.

The machine has an inlet hose with 3/4" B.S.P threaded end connection to attach between the threaded connector on the appliance and the cold water supply.

The appliance must only be connected to the cold water supply. Connection to a warm water supply, that is over 40°C, may damage certain delicate fabrics.

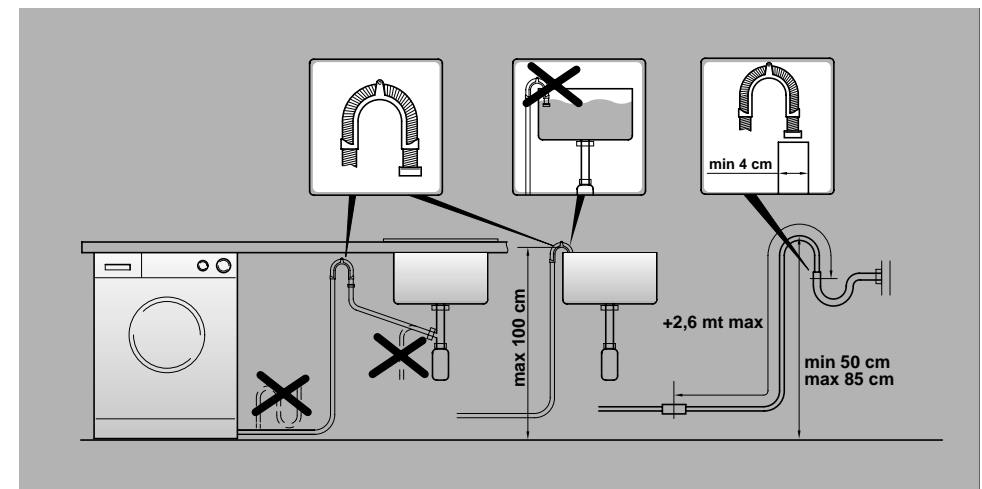
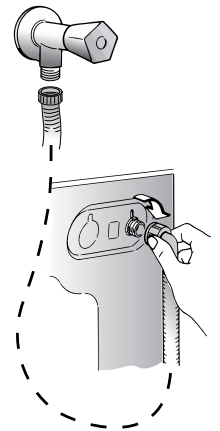

Note: it is advisable to turn off the tap after each wash to isolate the washing machine from the water supply.

For the washing machine to function properly the terminal end of the discharge hose (mouth) must be at a minimum of 50 cm and a maximum of 85 cm from the ground.

Electricity supply and safety advice

Washing machines are supplied to operate at a voltage of 230 V, 50 Hz single-phase.

Check that the conductor is powerful enough to supply at least 3.0 kW, then connect the plug to a 16 A earthed socket.

Check that the electricity supply to your home has an earthing system.

The socket in your home and the plug on the appliance must be of the same type.

It is generally not advisable to use multiple adapters and/or extension leads.

After installation, the appliance must be positioned so that the plug is accessible.

All **Maytag** washing machines comply with the safety requirements laid down by the Quality Trademark Institute.

NOTES

Ruled area for notes with horizontal dotted lines.

Lined writing area with horizontal dotted lines.

The manufacturer declines all responsibility in the event of any printing mistakes in this booklet. The manufacturer also reserves the right to make appropriate modifications to its products without changing the essential characteristics.

—MAYTAG SERVICE AND SPARES—

1300 858 575



MAYTAG (Aust.) Pty. Ltd. ABN: 88 086 686 884

**MAYTAG policy is one of continuous development and for this reason
we reserve the right to change specifications without prior notice.**



05.02 - 41014606.A - Printed in Italy - Imprimé en Italie

Free Manuals Download Website

<http://myh66.com>

<http://usermanuals.us>

<http://www.somanuals.com>

<http://www.4manuals.cc>

<http://www.manual-lib.com>

<http://www.404manual.com>

<http://www.luxmanual.com>

<http://aubethermostatmanual.com>

Golf course search by state

<http://golfingnear.com>

Email search by domain

<http://emailbydomain.com>

Auto manuals search

<http://auto.somanuals.com>

TV manuals search

<http://tv.somanuals.com>