



Power Amplifier



MC252 Owner's Manual

The lightning flash with arrowhead, within an equilateral triangle, is intended to alert the user to the presence of uninsulated "dangerous voltage" within the product's enclosure that may be of sufficient magnitude to constitute a risk of electric shock to persons.



AVIS RISQUE DE CHOC ELECTRIQUE - NE PAS OUVRIR.

The exclamation point within an equilateral triangle is intended to alert the user to the presence of important operating and maintenance (servicing) instructions in the literature accompanying the appliance.

WARNING - TO REDUCE RISK OF FIRE OR ELECTRICAL SHOCK, DO NOT EXPOSE THIS EQUIPMENT TO RAIN OR MOISTURE.

NO USER-SERVICEABLE PARTS INSIDE. REFER SERVICING TO QUALIFIED PERSONNEL.

To prevent the risk of electric shock, do not remove cover or back. No user serviceable parts inside.

IMPORTANT SAFETY INSTRUCTIONS!

PLEASE READ THEM BEFORE OPERATING THIS EQUIPMENT.

1. Read these instructions.
2. Keep these instructions.
3. Heed all warnings.
4. Follow all instructions.
5. Do not use this apparatus near water.
6. Clean only with a dry cloth.
7. Do not block any ventilation openings. Install in accordance with the manufacturer's instructions.
8. Do not install near any heat sources such as radiators, heat registers, stoves, or other apparatus (including amplifiers) that produce heat.
9. Do not defeat the safety purpose of the polarized or grounding-type plug. A polarized plug has two blades with one wider than the other. A grounding type plug has two blades and a third grounding prong. The wide blade or the third prong are provided for your safety. If the provided plug does not fit into your outlet, consult an electrician for replacement of the obsolete outlet.
10. Protect the power cord from being walked on or pinched particularly at plugs, convenience receptacles, and the point where they exit from the apparatus.
11. Only use attachments/accessories specified by the manufacturer.
12. Use only with the cart, stand, tripod, bracket, or table specified by the manufacturer, or sold with the apparatus. When a cart is used, use caution when moving the cart/apparatus combination to avoid injury from tip-over. 
13. Unplug this apparatus during lightning storms or when unused for long periods of time.
14. Refer all servicing to qualified service personnel. Servicing is required when the apparatus has been damaged in any way, such as power-supply cord or plug is damaged, liquid has been spilled or objects have fallen into the apparatus, the apparatus has been exposed to rain or moisture, does not operate normally, or has been dropped.
15. Do not expose this equipment to dripping or splashing and ensure that no objects filled with liquids, such as vases, are placed on the equipment.
16. To completely disconnect this equipment from the a.c. mains, disconnect the power supply cord plug from the a.c. receptacle.
17. The mains plug of the power supply cord shall remain readily operable.

Thank You

Your decision to own this McIntosh MC252 Power Amplifier ranks you at the very top among discriminating music listeners. You now have “The Best.” The McIntosh dedication to “Quality,” is assurance that you will receive many years of musical enjoyment from this unit.

Please take a short time to read the information in this manual. We want you to be as familiar as possible with all the features and functions of your new McIntosh.

Please Take A Moment

The serial number, purchase date and McIntosh Dealer name are important to you for possible insurance claim or future service. The spaces below have been provided for you to record that information:

Serial Number: _____

Purchase Date: _____

Dealer Name: _____

Technical Assistance

If at any time you have questions about your McIntosh product, contact your McIntosh Dealer who is familiar with your McIntosh equipment and any other brands that may be part of your system. If you or your Dealer wish additional help concerning a suspected problem, you can receive technical assistance for all McIntosh products at:

McIntosh Laboratory, Inc.
2 Chambers Street
Binghamton, New York 13903
Phone: 607-723-1545
Fax: 607-723-3636

Customer Service

If it is determined that your McIntosh product is in need of repair, you can return it to your Dealer. You can also return it to the McIntosh Laboratory Service Department. For assistance on factory repair return procedure, contact the McIntosh Service Department at:

McIntosh Laboratory, Inc.
2 Chambers Street
Binghamton, New York 13903
Phone: 607-723-3515
Fax: 607-723-1917

Table of Contents

Safety Instructions	2
Thank You and Please Take a Moment	3
Technical Assistance and Customer Service	3
Table of Contents and Important Information	3
Connector Information	4
Introduction	4
Performance Features	4
Dimensions	5
Installation	6
Top Panel Connections and Switch	7
How to Connect in Stereo	8
How to Connect in Mono Bridged Mode	10
How to Connect in Mono Bi-Amp (Parallel)	12
Front Panel Displays and Controls	14
How to Operate	15
Technical Description	16
Notes	20
Specifications	22
Packing Instruction	23

Important Information

Caution: The MC252 Amplifier weight is 94.5 pounds (42.87 kilograms). It requires two or more persons to safely handle when moving the amplifier.

1. The following Connecting Cable is available from the McIntosh Parts Department:
Power Control Cable Part No. 170-202
Six foot, 2 conductor shielded, with two 1/8 inch stereo mini phone plugs.
2. For additional connection information, refer to the owner's manual(s) for any component(s) connected to the MC252.
3. The MC252 mutes the speaker outputs for approximately two seconds when first turned on.
4. It is very important that loudspeaker cables of adequate size be used, so that there will be no power loss. The size is specified in Gauge Numbers or AWG, (American Wire Gauge). The smaller the Gauge number, the larger the wire size:
If your loudspeaker cables are 50 feet (38.1m) or less, use at least 14 Gauge.
If your loudspeaker cables are 100 feet (76.2m) or less, use at least 12 Gauge.
5. In the event the MC252 over heats, due to improper ventilation and/or high ambient temperature, the protection circuits will activate. The Power Guard LED will stay ON and the audio will be muted. When the MC252 has returned to a safe operating temperature, normal operation will resume.

Connector Information

XLR Connectors

Below is the Pin configuration for the XLR Balanced Input Connectors on the MC252. Refer to the diagram for connection:

- PIN 1: Shield/Ground
- PIN 2: + Input
- PIN 3: - Input

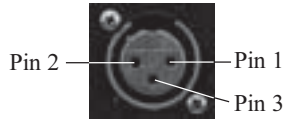

Power Control and Trigger Connectors

The MC252's Power Control Outputs provide a 5 volt signal. Use a 1/8 inch stereo mini phone plug to connect to the Power Control Input on other McIntosh Components.

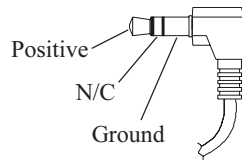

Introduction

Now you can take advantage of traditional McIntosh standards of excellence in the MC252 Power Amplifier. The 250 watt high current outputs will drive any high quality Loudspeaker System to its ultimate performance. The MC252 reproduction is sonically transparent and absolutely accurate. The McIntosh Sound is "The Sound of the Music Itself."

Performance Features

● Power Output

The MC252 consists of two separate power amplifier channels, each capable of 250 watts into 2, 4 or 8 ohm speakers with less than 0.005% distortion. The two channels can be combined into a single channel with 500 watts into 1, 2, 4, 8 or 16 ohm speakers with less than 0.005% distortion.

● Patented Autoformers

The McIntosh designed and manufactured Output Autoformers provide an ideal match between the amplifier output stage and speaker loads of 2, 4 and 8 ohms. The Autoformers also provide perfect DC protection for your valuable Loudspeakers.

● Patented Power Guard

The patented McIntosh Power Guard Circuit prevents the amplifier from being over driven into clipping, with its harsh distorted sound that can also damage your valuable Loudspeakers.

● Balanced and Unbalanced Inputs

Balanced connections guard against induced noise and allow long cable runs without compromising sound quality.

● Patented Sentry Monitor with Thermal Protection

McIntosh Sentry Monitor power output stage protection circuits ensure the MC252 will have a long and trouble free operating life. Built-in Thermal Protection Circuits guard against overheating.

● Power Control

The McIntosh Power Control Circuit allows for remote turn-on of the MC252 Power Amplifier from a McIntosh Audio/Video Control Center or Preamplifier. If any additional McIntosh Power Amplifiers are part of the system, a delayed Power Control Output Trigger is available. This delayed Trigger reduces the strain on the house's electrical wiring and protection devices.

● Illuminated Power Meters

The Illuminated Power Output Watt Meters on the MC252 are peak responding, and indicate the power output of the amplifier. The Peak Watt Hold Mode allows the meter to temporarily stay at the highest power output and then slowly decay. The Front Panel Meter Illumination may be switched Off at any time.

● Fiber Optic Solid State Front Panel Illumination

The Illumination of the Front Panel is accomplished by the combination of custom designed Fiber Optic Light Diffusers and Light Emitting Diodes (LEDs). This provides even Front Panel Illumination, together with the extra long life LEDs.

● Glass Front Panel and Super Mirror Chassis Finish

The famous McIntosh Illuminated Glass Front Panel with a three dimensional look and the Stainless Steel Chassis with Super Mirror Finish ensures the pristine beauty of the MC252 will be retained for many years.

Connector Information, Introduction, Performance Features and Dimensions

The following dimensions can assist in determining the best location for your MC252. There is additional information on the next page pertaining to installing the MC252 into cabinets.

Front View of the MC252



Rear View of the MC252

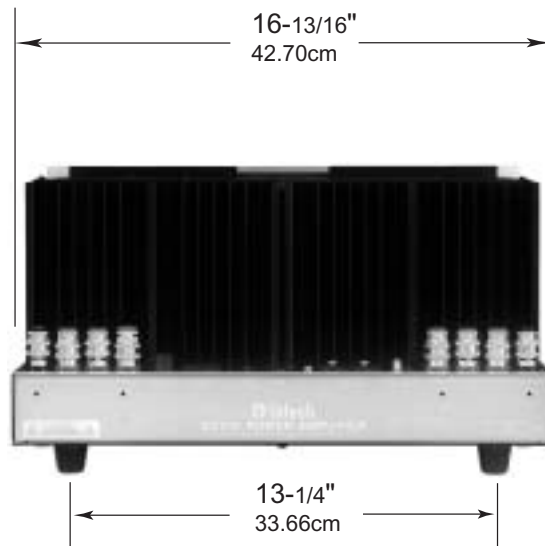

Side View of the MC252

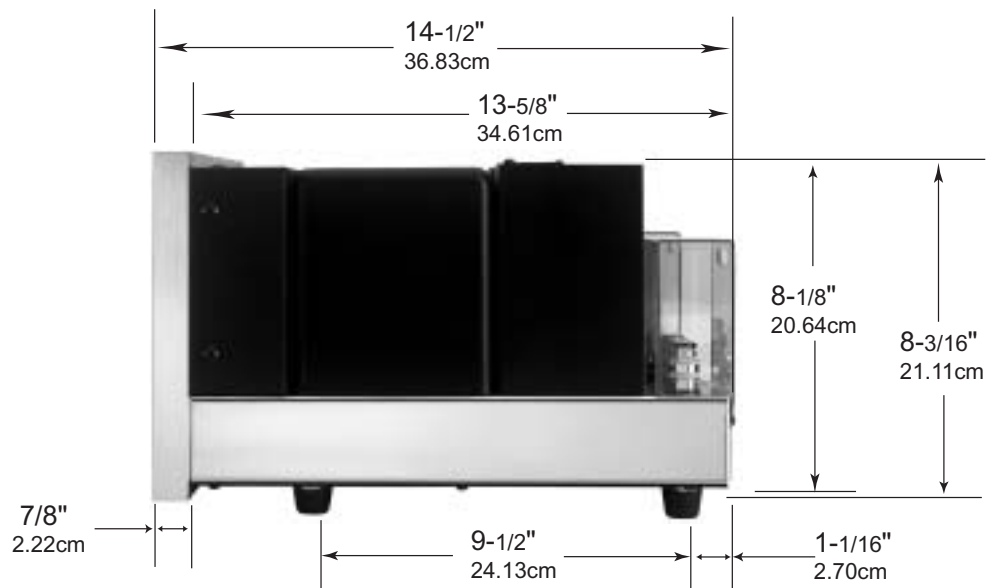

Installation

Caution: The MC252 Amplifier weight is 94.5 pounds (42.87 kilograms). It requires two or more persons to safely handle when moving the amplifier.

The MC252 can be placed upright on a table or shelf, standing on its four feet. The four feet may be removed from the bottom of the MC252 when it is custom installed as outlined below. The four feet together with the mounting screws should be retained for possible future use if the MC252 is removed from the custom installation and used free standing. It also can be custom installed in a piece of furniture or cabinet of your choice. The required panel cutout, ventilation cutout and unit dimensions are shown.

Always provide adequate ventilation for your MC252. Cool operation ensures the longest possible operating life for any electronic instrument. Do not install the MC252 directly above a heat generating component such as a high powered amplifier. If all the components are installed in a single cabinet, a quiet running ventilation fan can be a definite asset in maintaining all the system components at the coolest possible operating temperature.

A custom cabinet installation should provide the following minimum spacing dimensions for cool operation. Allow at least 6 inches (15.24 cm) above the top, 2 inches (3.81cm) below the bottom and 1 inch (2.54 cm) on each side of the amplifier, so that airflow is not obstructed. Allow 16 inches

(40.64 cm) depth behind the front panel. Allow 1-3/16 inches (3.02 cm) in front of the mounting panel for knob clearance. Be sure to cut out a ventilation hole in the mounting shelf according to the dimensions in the drawing.

MC252 Front Panel Custom Cabinet Cutout

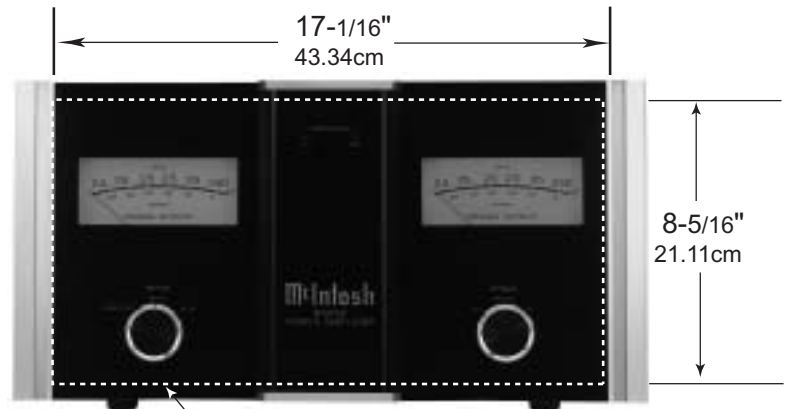

Cutout Opening for Custom Mounting

Alternate Rear Foot Location

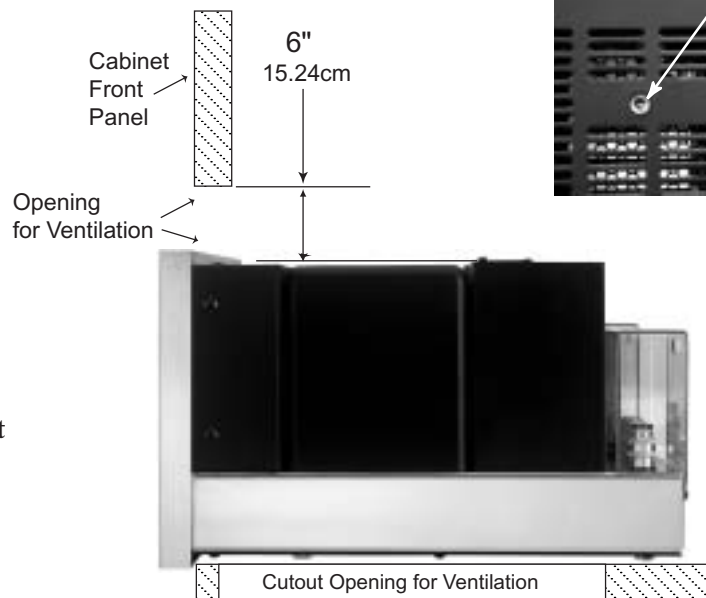
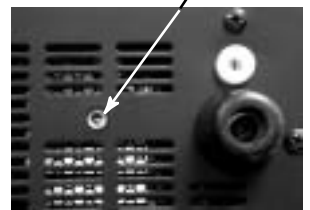

MC252 Side View in Custom Cabinet

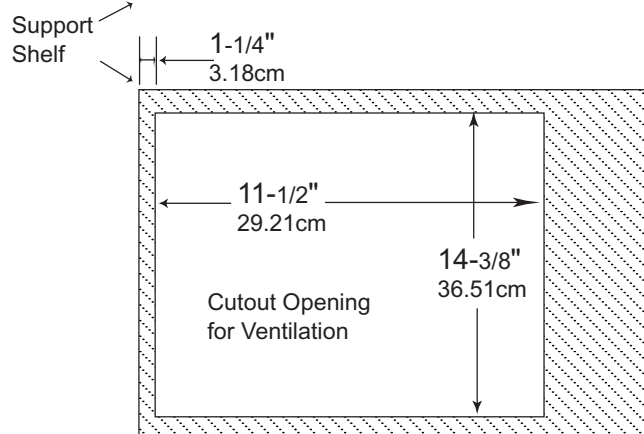

MC252 Bottom View in Custom Cabinet

Top Panel Connections and Switch

Main Fuse holder, refer to information on the top back panel of the MC252 to determine the correct fuse size and rating

POWER CONTROL IN receives a turn On/Off Trigger from a McIntosh component. POWER CONTROL OUT sends a turn On/Off Trigger to the next McIntosh component

UNBALANCED INPUTS for an audio cable from a preamplifier or control center audio outputs

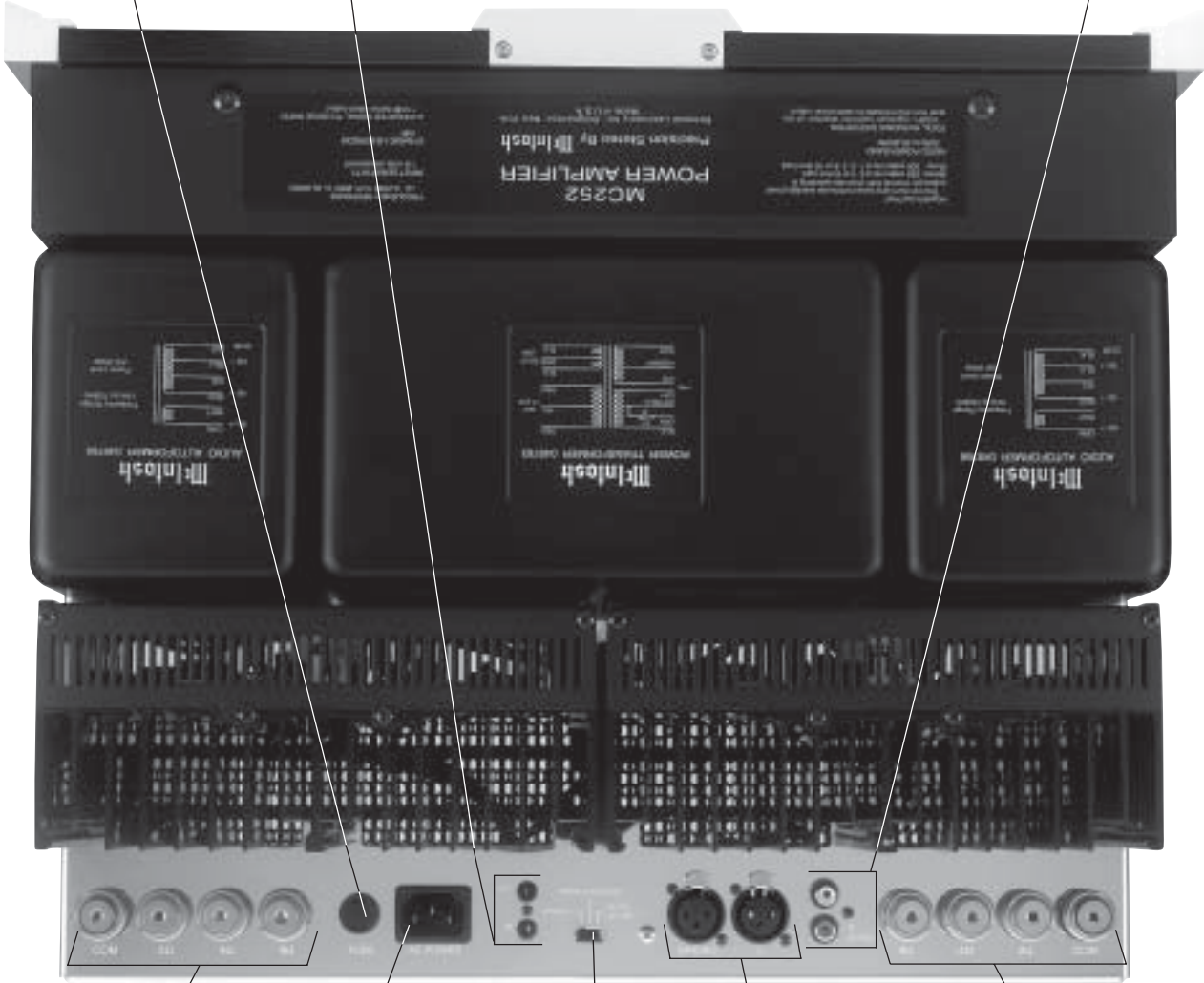

RIGHT Channel OUTPUTS connections for 2 ohm, 4 ohm and 8 ohm Loudspeakers

Connect the MC252 power cord to a live AC outlet. Refer to information on the back panel to determine the correct voltage

MODE switch selects between three modes of operation; STEREO, MONO (BRIDGED) or MONO (BI-AMP) Parallel

BALANCED INPUTS for an audio cable from a preamplifier or control center audio outputs

LEFT Channel OUTPUTS connections for 2 ohm, 4 ohm and 8 ohm Loudspeakers

How to Connect in Stereo

Caution: The supplied AC Power Cord should not be connected to the Rear Panel of the MC252 Amplifier until after the Loudspeaker Connections have been made and the supplied protective Terminal Connection Covers have been installed. Failure to observe this could result in Electric Shock.

1. For Remote Power Control, connect a power control cable from the Control Center or Preamplifier Power Control Out to the MC252 Power Control In.
2. Connect cables from the Unbalanced Output of a McIntosh Preamplifier or Control Center to the MC252 Unbalanced Inputs.

Note: An optional hookup is to use balanced cables.

3. Prepare the Loudspeaker Hookup Cables that attach to the MC252 Power Amplifier by choosing one of the methods below:

Bare wire cable ends:

Carefully remove sufficient insulation from the cable ends, refer to figures 1, 2 & 3. If the cable is stranded, carefully twist the strands together as tightly as possible.

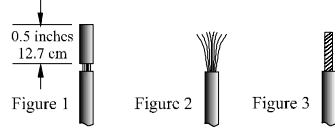

Note: If desired, the twisted ends can be tinned with solder to keep the strands together, or attach spade lug and/or banana connector.

Spade lug or prepared wire connection:

Insert the spade lug connector or prepared section of the cable end into the terminal side access hole, and tighten the terminal cap until the cable is firmly clamped into the terminal so the wires cannot slip out. Refer to figures 4, 5 & 6.

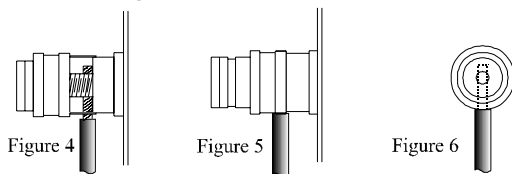

Banana plug connection:

Insert the banana plug into the hole at the top of the terminal. Tighten the top portion of the terminal post and the set screw to secure the banana plug in place.

Note: The use of Banana Plugs is for use in the United States and Canada only.

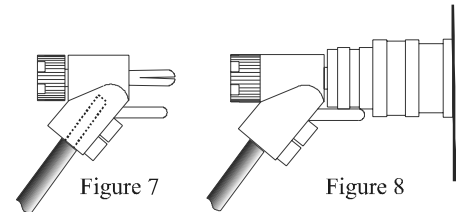

4. Connect the Loudspeaker hookup cables to the output terminals that match the impedance of the Loudspeaker, being careful to observe the correct polarities. Output impedance connections of 2Ω (ohm), 4Ω (ohm) and 8Ω (ohm) are provided. If the Loudspeaker's impedance is in-between the available connections, use the nearest lower impedance connection.

WARNING: Loudspeaker terminals are hazardous live and present a risk of electric shock. For additional instruction on making Loudspeaker Connections contact your McIntosh Dealer or McIntosh Technical Support.

5. Attach the supplied Terminal Connection Covers with the four Mounting Screws (6-32 x 1/4 inch Phillips Head) to the Rear Panel of the MC252 Amplifier. Refer to figure 9.

Note: The illustration in figure 9 is for the purpose of installing the Terminal Connection Covers, showing the opening on the covers for the Loudspeaker Cables to exit the MC252. It is not intended to show which terminal connections to use.

6. Connect the MC252 power cord to an active AC outlet.

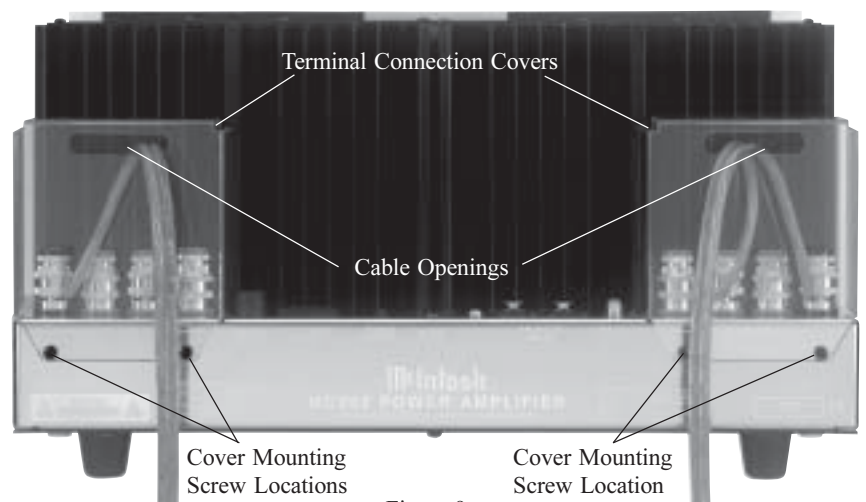
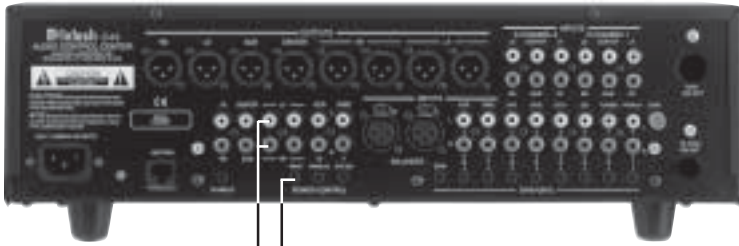
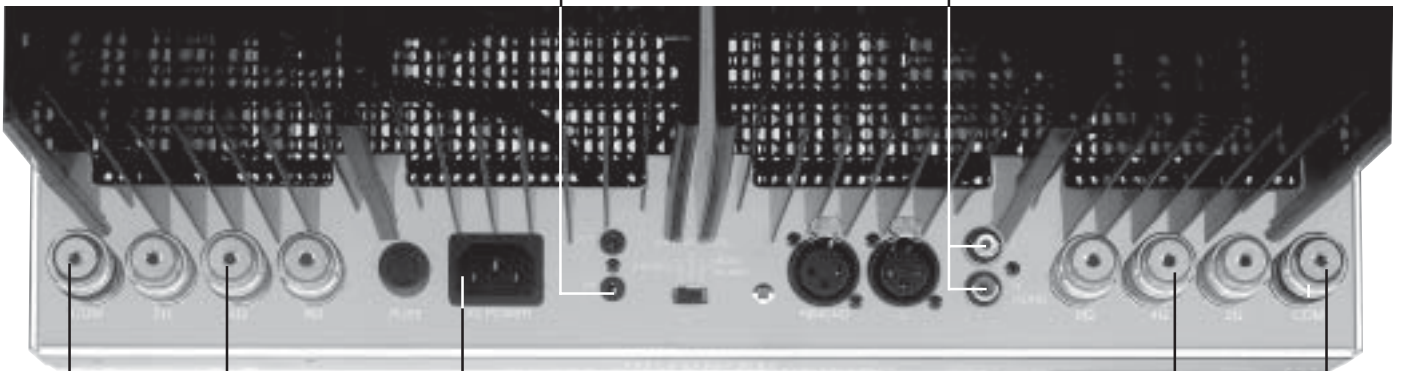

Figure 9

McIntosh C45 Audio Control Center



MC252 Top Rear View



To AC Outlet



4 ohm
Loudspeaker



4 ohm
Loudspeaker

How to Connect in Mono Bridged Mode

Caution: The supplied AC Power Cord should not be connected to the Rear Panel of the MC252 Amplifier until after the Loudspeaker Connections have been made and the supplied protective Terminal Connection Covers have been installed. Failure to observe this could result in Electric Shock.

There are two different ways of operating the MC252 monoaurally, Mono Bridged Mode and Mono Bi-Amp (Parallel) Mode. The Mono Bridge Mode allows for Loudspeakers of 4Ω (ohm), 8Ω (ohm) or 16Ω (ohm) impedance to be connected to the MC252. The Mono Bi-Amp (Parallel) Mode allows for Loudspeakers of 1Ω (ohm), 2Ω (ohm) or 4Ω (ohm) impedance to be connected to the MC252.

Choose the appropriate Mono Mode determined by the impedance of your Loudspeakers. If the Mono Bi-Amp (Parallel) Mode is appropriate for the Loudspeakers, proceed to page 12 for proper connections.

1. For Remote Power Control, connect a power control cable from the Control Center or Preamplifier Power Control Out to the MC252 Power Control In.
2. Connect cables from the Unbalanced Output of a McIntosh Preamplifier or Control Center to the MC252 Unbalanced R/MONO Input.

Note: An optional hookup is to use balanced cables.

3. Prepare the Loudspeaker Hookup Cables that attach to the MC252 Power Amplifier by choosing one of the methods below:

Bare wire cable ends:

Carefully remove sufficient insulation from the cable ends, refer to figures 1, 2 & 3. If the cable is stranded, carefully twist the strands together as tightly as possible.

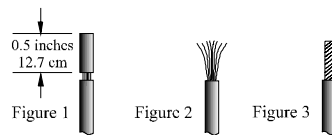

Note: If desired, the twisted ends can be tinned with solder to keep the strands together, or attach spade lug and/or banana connector.

Spade lug or prepared wire connection:

Insert the spade lug connector or prepared section of the cable end into the terminal side access hole, and tighten the terminal cap until the cable is firmly clamped into the terminal so the wires cannot slip out. Refer to figures 4, 5 & 6.

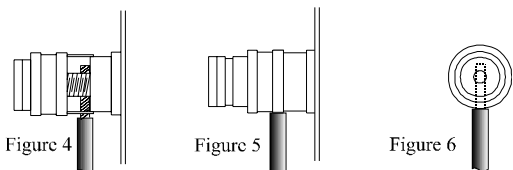

Banana plug connection:

Insert the banana plug into the hole at the top of the terminal. Tighten the top portion of the terminal post and the set screw to secure the banana plug in place. Refer to figures 7 and 8.

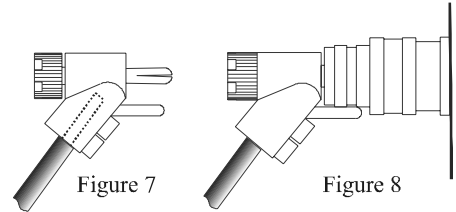

Note: The use of Banana Plugs is for use in the United States and Canada only.

4. Referring to the “Mono Bridge Hookup Connections” Chart on the next page, connect the Loudspeaker hookup cables to appropriate output terminals based on the impedance of the Loudspeaker (4Ω [ohm], 8Ω [ohm] or 16Ω [ohm]), being careful to observe the correct polarities. If the Loudspeaker’s impedance is in-between the available connections, use the nearest lower impedance connection.

WARNING: Loudspeaker terminals are hazardous live and present a risk of electric shock. For additional instruction on making Loudspeaker Connections contact your McIntosh Dealer or McIntosh Technical Support.

5. Attach the supplied Terminal Connection Covers with the four Mounting Screws (6-32 x 1/4 inch Phillips Head) to the Rear Panel of the MC252 Amplifier. Refer to figure 9.

Note: The illustration in figure 9 is for the purpose of installing the Terminal Connection Covers, showing the opening on the covers for the Loudspeaker Cables to exit the MC252. It is not intended to show which terminal connections to use.

6. Connect the MC252 power cord to an active AC outlet.

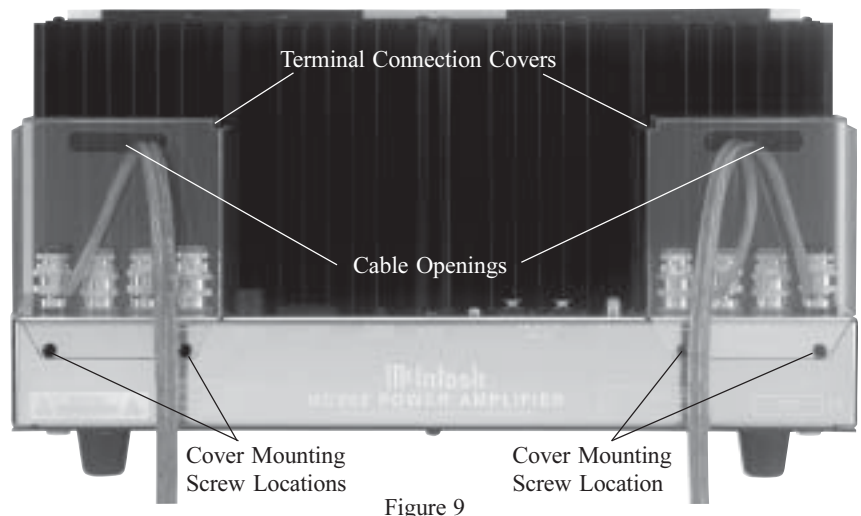

McIntosh C45 Audio Control Center



MC252 Top Rear View

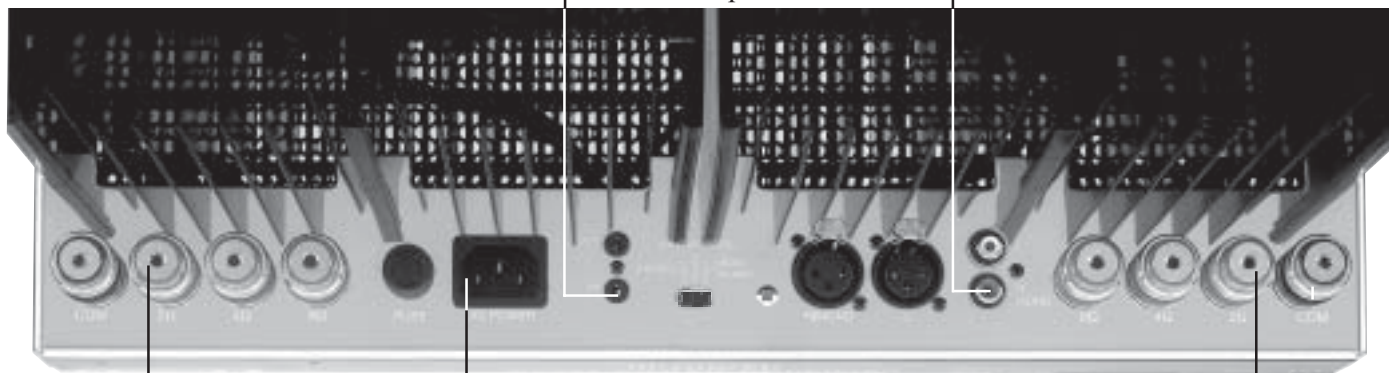

To AC Outlet



4 ohm Loudspeaker

Mono Bridge Hookup Connections		
Loudspeaker Impedance	Loudspeaker Negative (-) Connection	Loudspeaker Positive (+) Connection
4Ω (Ohm)	Left Output 2Ω Positive (+) Connection	Right Output 2Ω Positive (+) Connection
8Ω (Ohm)	Left Output 4Ω Positive (+) Connection	Right Output 4Ω Positive (+) Connection
16Ω (Ohm)	Left Output 8Ω Positive (+) Connection	Right Output 8Ω Positive (+) Connection

How to Connect in Mono Bi-Amp (Parallel) Mode

Caution: The supplied AC Power Cord should not be connected to the Rear Panel of the MC252 Amplifier until after the Loudspeaker Connections have been made and the supplied protective Terminal Connection Covers have been installed. Failure to observe this could result in Electric Shock.

There are two different ways of operating the MC252 monoaurally, Mono Bridged Mode and Mono Bi-Amp (Parallel) Mode. The Mono Bridge Mode allows for Loudspeakers of 4Ω (ohm), 8Ω (ohm) or 16Ω (ohm) impedance to be connected to the MC252. The Mono Bi-Amp (Parallel) Mode allows for Loudspeakers of 1Ω (ohm), 2Ω (ohm) or 4Ω (ohm) impedance to be connected to the MC252.

Choose the appropriate Mono Mode determined by the impedance of your Loudspeakers. If the Mono Bridge Mode is appropriate for the Loudspeakers, proceed to page 10 for proper connections.

1. For Remote Power Control, connect a power control cable from the Control Center or Preamplifier Power Control Out to the MC252 Power Control In.
2. Connect cables from the Unbalanced Output of a McIntosh Preamplifier or Control Center to the MC252 R/MONO Unbalanced Input.

Note: An optional hookup is to use balanced cables.

3. The MC252 Mono Bi-Amp (Parallel) Mode of Operation requires a Hookup Cable and jumper wires for connection to the Power Amplifier Output Terminals; two 22 inch (55.88 cm) Jumper wires, and one Loudspeaker Hookup Cable cut to the desired length. Prepare the cable and wires by choosing one of the methods below:

Bare wire cable ends:

Carefully remove sufficient insulation from the cable/wire ends, refer to figures 1, 2 & 3. If the cable/wire is stranded, carefully twist the strands together as tightly as possible.

Note: If desired, the twisted ends can be tinned with solder to keep the strands together, or attach spade lug and/or banana connector.

Spade lug or prepared wire connection:

Insert the spade lug connector or prepared section of the cable/wire end into the terminal side access hole, and tighten the terminal cap until the cable/wire is firmly clamped into the terminal so they cannot slip out. Refer to figures 4, 5 & 6.

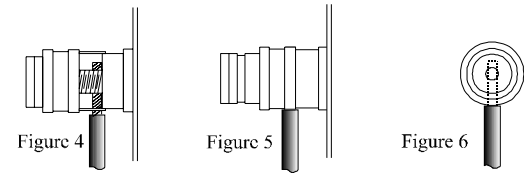
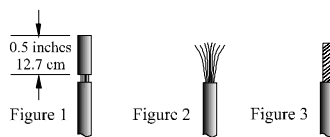

Banana plug connection:

Insert the banana plug into the hole at the top of the terminal. Tighten the top portion of the terminal post and the set screw to secure the banana plug in place.

Refer to figures 7 and 8.

Note: The use of Banana Plugs is for use in the

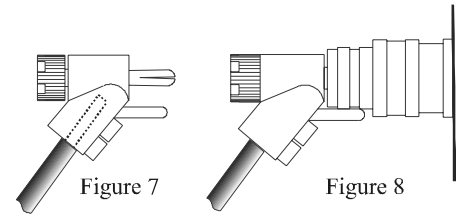

United States and Canada only.

4. Refer to the "Mono Bi-Amp (Parallel) Hookup Connections" Chart on the next page for making the following connections.
5. Insert the Loudspeaker Hookup Cable Ends through the opening of both supplied Terminal Connection Covers and connect the one of prepared Jumper Wire between the two - Output Terminals and the other Jumper Wire between the two appropriate Impedance + Output Terminals. Connect the Loudspeaker hookup cable to appropriate output terminals based on the impedance of the Loudspeaker (1Ω [ohm], 2Ω [ohm] or 4Ω [ohm]), being careful to observe the correct polarities. If the Loudspeaker's impedance is in-between the available connections, use the nearest lower impedance connection.

WARNING: Loudspeaker terminals are hazardous live and present a risk of electric shock. For

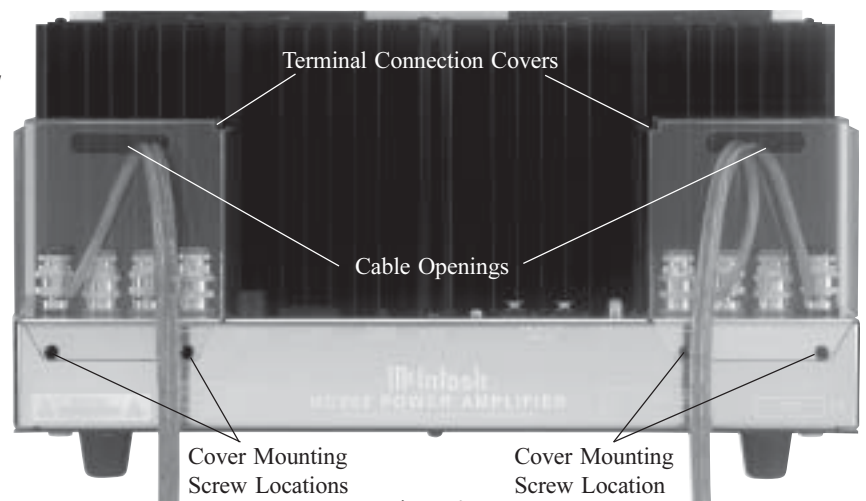

Figure 9

additional instruction on making Loudspeaker Connections contact your McIntosh Dealer or McIntosh Technical Support.

- Attach the supplied Terminal Connection Covers with the four Mounting Screws (6-32 x 1/4 inch Phillips Head) to the Rear Panel of the MC252 Amplifier. Refer to figure 9.

Note: The illustration in figure 9 is for the purpose of installing the Terminal Connection Covers, showing the opening on the covers for the Loudspeaker Cables to exit the MC252. It is not intended to show which terminal connections to use.

- Connect the MC252 power cord to an active AC outlet.

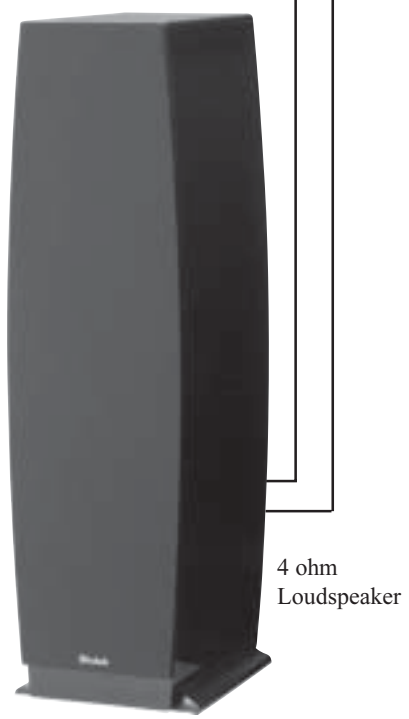
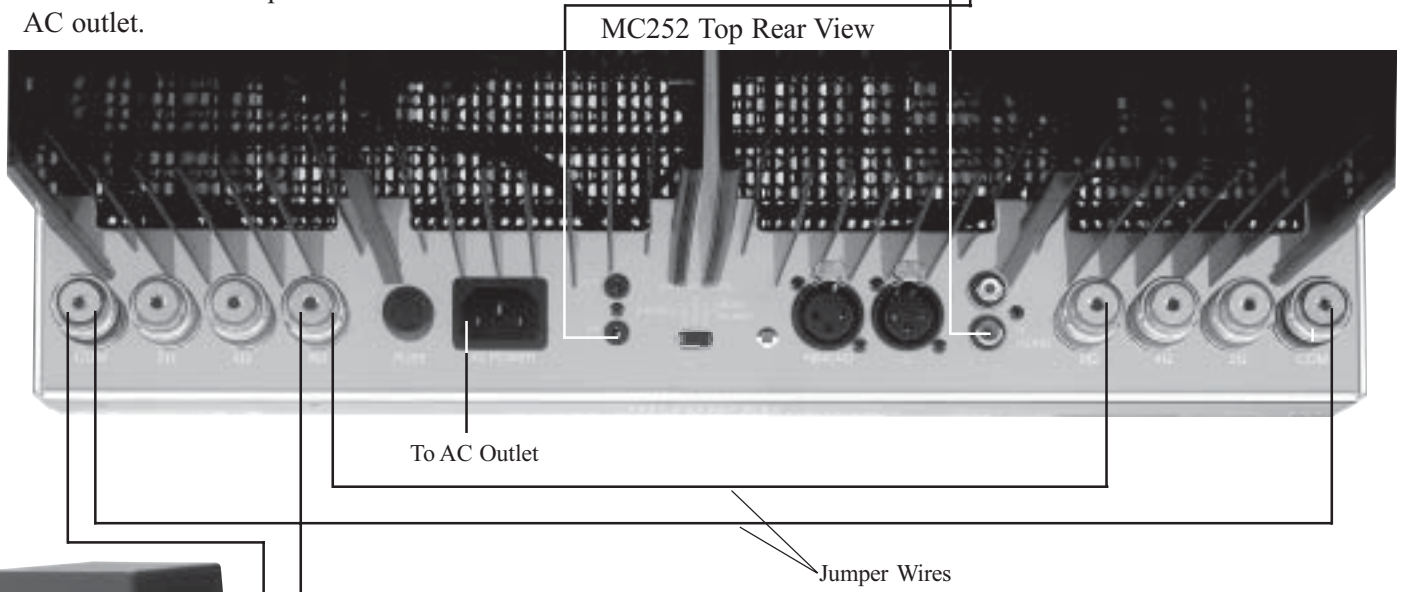
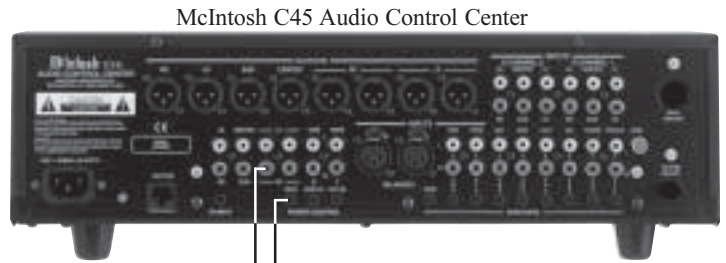

Mono Bi-Amp (Parallel) Hookup Connections		
Loudspeaker Impedance	Loudspeaker Negative (-) Connection	Loudspeaker Positive (+) Connection
1Ω (Ohm)	Left and Right Output 2Ω Negative (-) Connection	Left and Right Output 2Ω Positive (+) Connection
2Ω (Ohm)	Left and Right Output 4Ω Negative (-) Connection	Left and Right Output 4Ω Positive (+) Connection
4Ω (Ohm)	Left and Right Output 8Ω Negative (-) Connection	Left and Right Output 8Ω Positive (+) Connection

METER indicates the Power Output of the Left Channel Amplifier

METER indicates the Power Output of the Right Channel Amplifier

Remote On Indicator lights when the amplifier is in the Remote Turn-On Mode

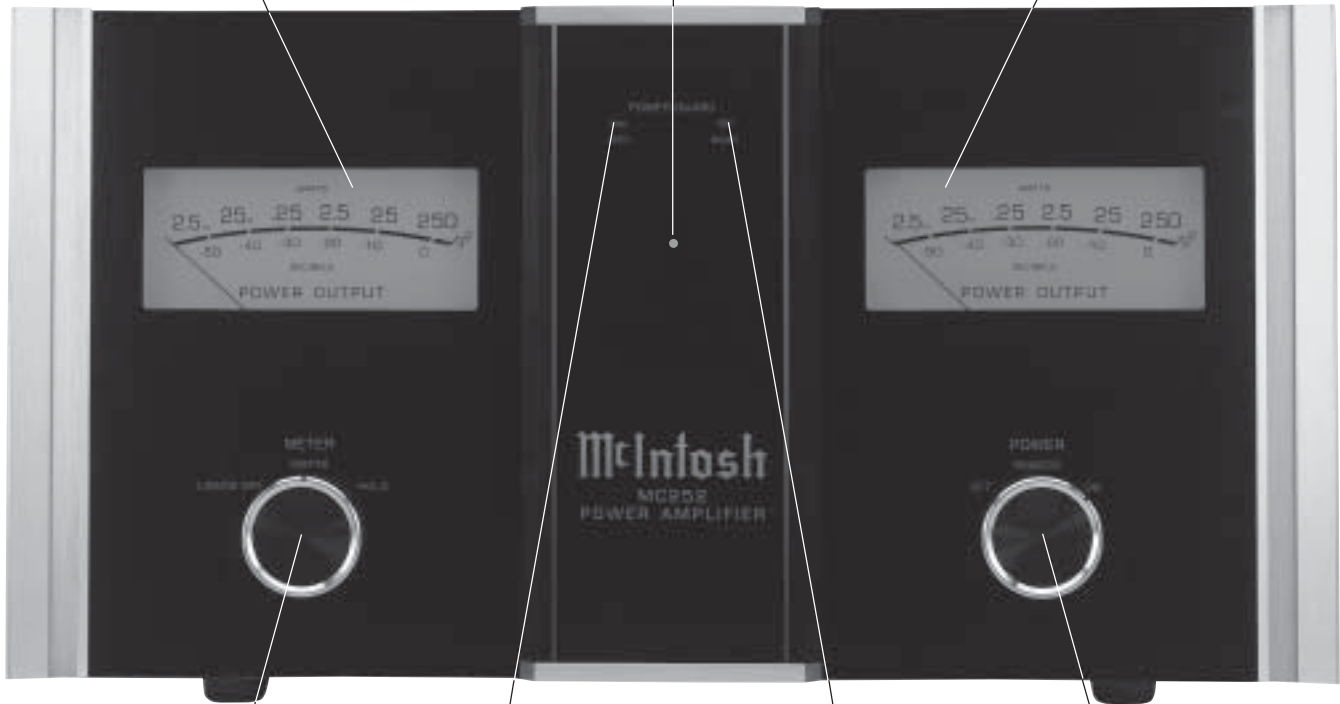

METER Switch selects the display modes of the Power Output Meter

POWER Switch Turns AC power On/Off, or On/Remote

POWER GUARD LED lights when the amplifier Left Channel POWER GUARD circuit activates

POWER GUARD LED lights when the amplifier Right Channel POWER GUARD circuit activates

How to Operate

Power On

To have the MC252 automatically turn On or Off when a control center turns on or off, rotate the power switch to the remote position. For manual operation, rotate the power switch to the On or Off position as desired. Refer to figure 10.

Note: There must be a power control connection between the MC252 and the McIntosh Control Center, in order for the remote power turn-on to function.



Figure 10

Meter Selection

Rotate the meter mode switch to select the meter operation mode you desire. Refer to figures 11 and 12.

Lights Off - Meter lights are turned off and the meter will continue to indicate the power output.

Watts - The meters respond to all the musical information being produced by the amplifier. They indicate to an accuracy of at least 95% of the power output with only a single cycle of a 2000Hz tone burst.

Hold - The meter pointer is locked to the highest power peak in a sequence of peaks. It is electronically held to this power level until a



Figure 11

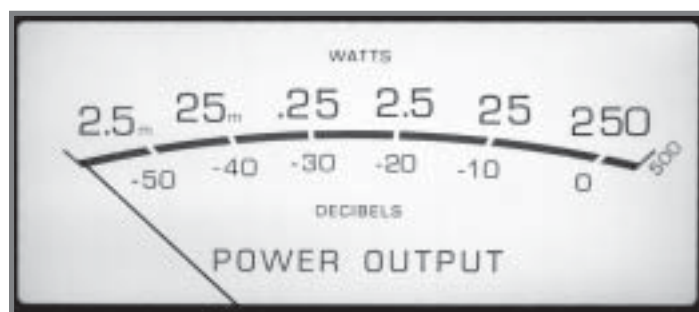

Figure 12

higher power peak passes through the amplifier. The meter pointer will then rise to the newer higher indication. If no further power peaks are reached, the meter pointer will very

slowly return to its rest position or lower power level. The decay rate is approximately 6dB per minute.

Mode Switch

The STEREO/MONO BRIDGED/MONO BI-AMP (Parallel) Mode Switch, which is located to the left of the R/MONO BALANCED INPUT (XRL Connector) on the Top Rear Panel of the MC252 and allows selection of either Stereo or two different Mono Modes of Operation. Refer to figures 13.



Figure 13

Note: There is additional information for connecting the MC252 and pertaining to all modes of operation: "How to Connect for Stereo" on pages 8 and 9. "How to Connect for Mono Bridged" on pages 10 and 11. "How to Connect for Mono Bi-Amp (Parallel)" on pages 12 and 13.

Technical Description

McIntosh Laboratory, the company who introduced the world's first amplifier that could be called "High Fidelity", has done it again. The McIntosh engineering staff has created a power amplifier without compromise, using the most advanced McIntosh circuit design concepts.

A continuous average power output rating of 250 watts and with an output current of greater than 50 amperes per channel, making this one of the most advanced and powerful amplifiers McIntosh has ever manufactured. The distortion limits for the MC252 are no more than 0.005% at rated power output for all frequencies from 20Hz to 20,000Hz. Typical performance at mid frequencies is less than 0.002%. The true distortion readings on the MC252 are so low, it takes special measuring techniques to make accurate readings. The MC252 can deliver the best possible performance from any type of high quality loudspeaker system.

Creating an amplifier with this level of performance did

not come easily. Many months of design, testing and measuring were required. Extensive controlled listening tests, the ultimate form of measuring, were made before the final design was accepted.

Design Philosophy

The design philosophy incorporated in the MC252 involved several different techniques, all based on sound scientific logic. Refer to figure 14. Every stage of voltage or current amplification must be as linear as possible prior to the use of negative feedback. McIntosh engineers know how to properly design negative feedback circuits so they contribute to the extremely low distortion performance expected from a McIntosh amplifier. The typical McIntosh owner would never accept the approximately 100 times higher distortion of many non-feedback designs.

All transistors are selected to have nearly constant cur-

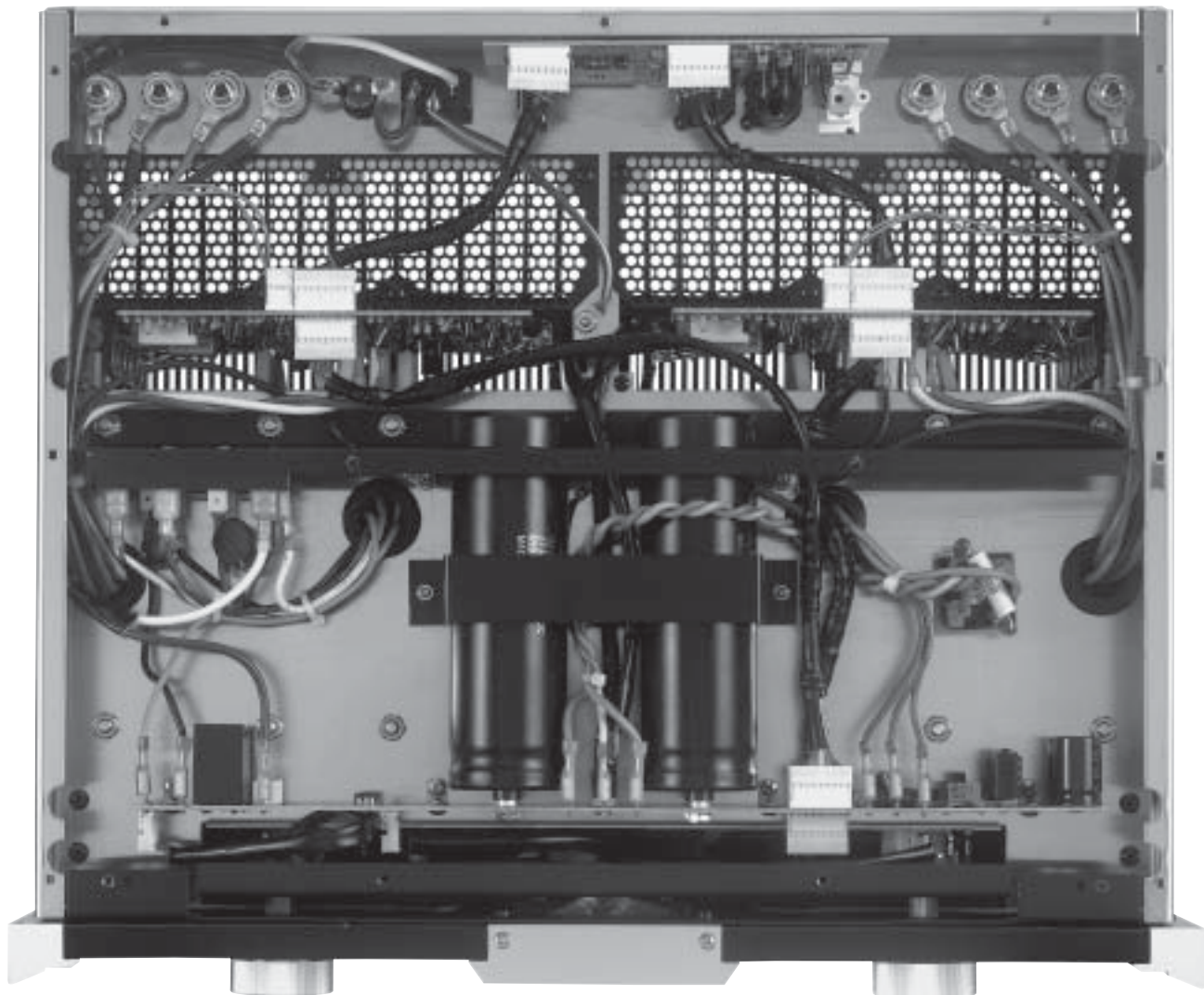

Inside View of the MC252

rent gain over the entire current range they must cover. Output transistors in particular, have matched uniform current gain, high current-bandwidth product and large active region safe operating area. An automatic tracking bias system completely eliminates any trace of crossover distortion. Precision metal film resistors and low dielectric absorption film capacitors are used in all critical circuit locations.

The output signal of the circuit is coupled together in the unique McIntosh MC252 Output Autoformer. It provides low distortion power transfer at frequencies from below 20Hz to well beyond 20,000Hz with optimum impedance points of two ohms, four ohms and eight ohms. The unequaled expertise of McIntosh in the design and manu-

facturing of autoformers is legendary in the high fidelity industry.

The high efficiency circuit design of the MC252 contributes to low operating temperatures. More than 621 square inches of heat sink area keep the MC252 operating safely with convection cooling. No fans are needed.

Autoformers

All solid state power amplifier output circuits work best into what is called an optimum load. This optimum load may vary considerably from what a loudspeaker requires. In the case of more than one loudspeaker connected in parallel, the load to the power amplifier may drop to two ohms or even less. A power amplifier connected to a load that is

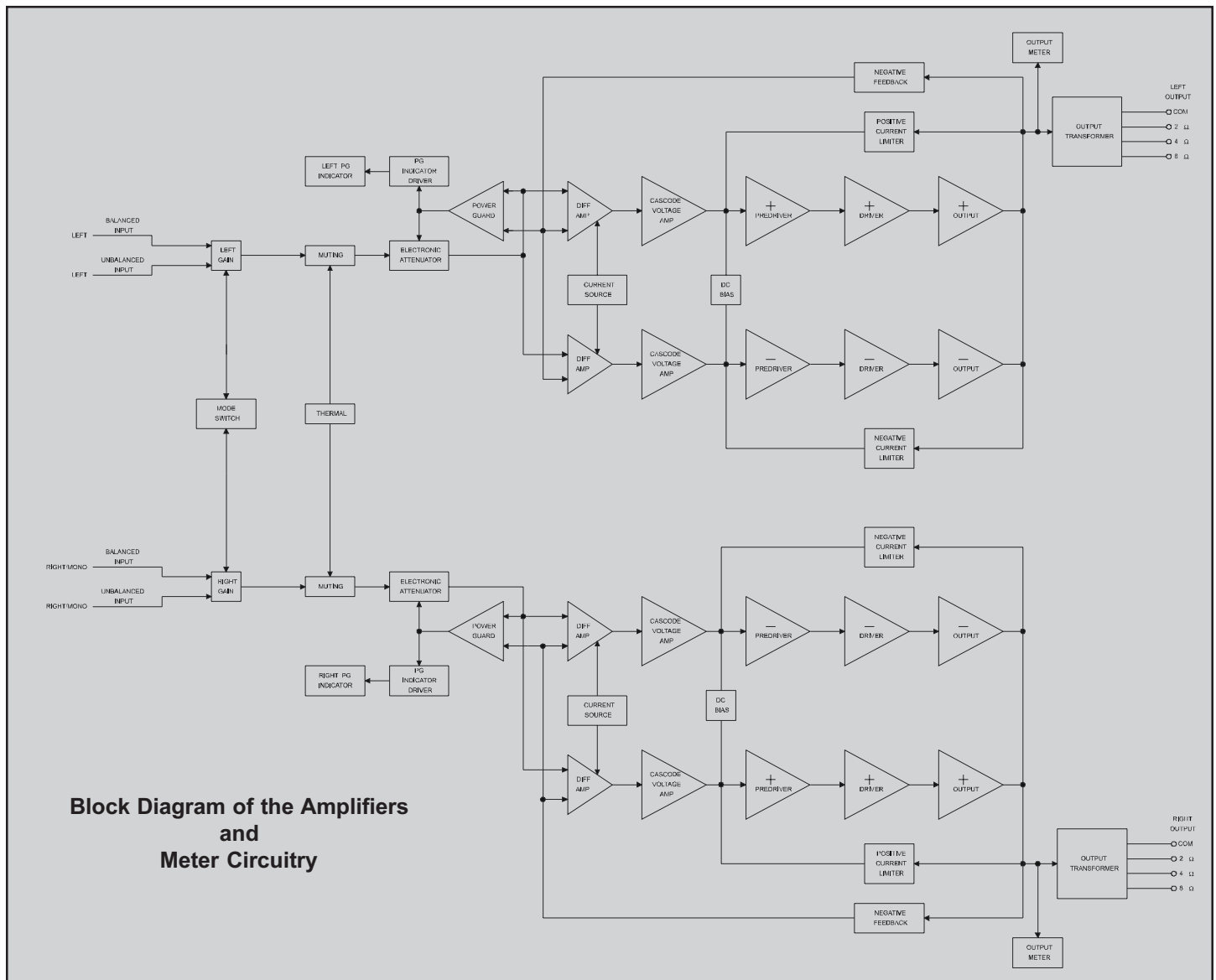

Figure 14

lower than optimum, causes more output current to flow, which results in extra heat being generated in the power output stage. This increase in temperature will result in a reduced life expectancy for the amplifier.

The Autoformer creates an ideal match between the power amplifier output stage and the loudspeaker. Refer to figure 15. There is absolutely no performance limitation

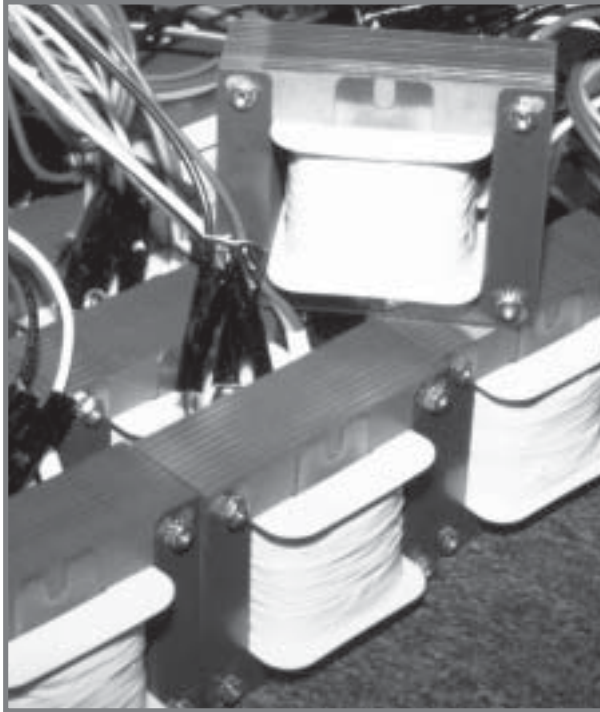

Figure 15

with an Autoformer. Its frequency response exceeds that of the output circuit itself, and extends well beyond the audible range. Its distortion level is so low it is virtually impossible to measure. In the rare event of a power amplifier output circuit failure, the McIntosh Autoformer provides absolute protection from possible damage to your valuable loudspeakers.

Protection Circuits

The MC252 incorporates its version of the McIntosh Sentry Monitor output transistor protection circuit. Refer to figure 16. There is absolutely no compromise in sonic performance with this circuit, and it ensures safe operation of the

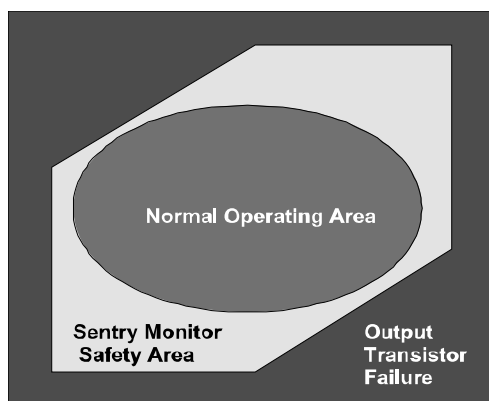

Figure 16

amplifier under even the most extreme operating conditions. The different types of protection circuits incorporated in the MC252 insure a long and safe operating life.

The MC252 also includes the unique patented McIntosh Power Guard circuit. Power Guard eliminates the possibility of ever overdriving the amplifier into clipping. Refer to figures 17, 18 and 19. An overdriven amplifier can produce both audible and inaudible distortion levels exceeding 40%. The audible distortion is unpleasant to hear, but the inaudible ultra-sonic distortion is also undesirable, since it can damage valuable loudspeaker system tweeters. You will never experience the harsh and damaging distortion due to clipping.

The Power Guard circuit is a waveform comparator, monitoring both the input and output waveforms. Under normal operating conditions, there are no differences between the shape of these waveforms. If an amplifier channel is overdriven, there will be a difference between the two signal waveforms. When the difference exceeds 0.3% (equivalent to 0.3% harmonic distortion), the Power Guard activates the PG light and a dynamic elec-

Input Test Signal

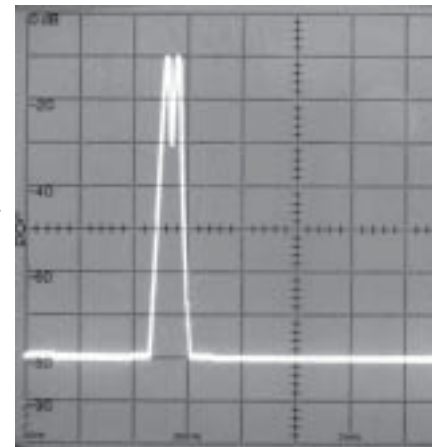

Figure 17

Without Power Guard

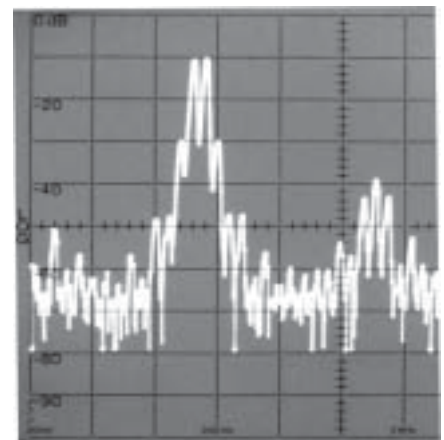

Figure 18

With Power Guard

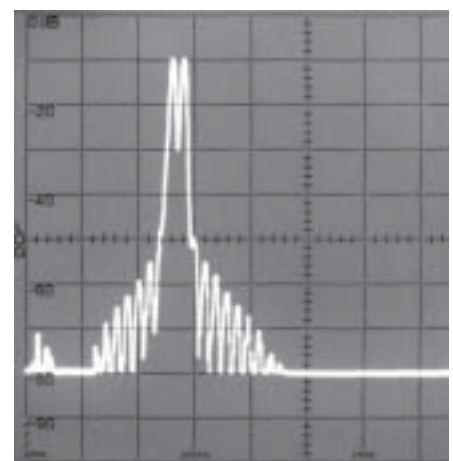

Figure 19

tronic attenuator at the amplifier input reduces the input volume just enough to prevent any further increase in distortion. The Power Guard circuit acts so fast that there are absolutely no audible side effects and the sonic purity of the music reproduction is perfectly preserved. The MC252 Power Amplifier with Power Guard is not limited to just the rated power output, but will actually produce distortion free output well above its rated power due to the McIntosh philosophy of conservative design.

Power Supply Circuits

To compliment the design of the MC252, there is a high voltage power supply for both channels. Refer to figure 20. The power amplifiers draw high current from the AC power line. Therefore, it is important that they plug directly into the wall outlet.

Also, most owners desire that there be one power switch for the whole audio system. The MC252 is equipped with a circuit that provides remote Power Control from

your McIntosh Preamplifier or Control Center. When you turn on your preamplifier a digital “1” (+5V) signal operates the power relay in the MC252. The MC252 also has a remote Power Control Out Jack. The Power Control signal from this jack is delayed by a fraction of a second so that the turn on power surge of the next power amplifier occurs at a later time. This helps prevent power circuit overload that could trip circuit breakers or blow fuses, a very important feature in a high power Home Theater System employing three MC252 Power Amplifiers.

The MC252 can provide greater than 50 amperes peak output current to drive uneven speaker loads. Some poor speaker designs have input impedance that dip to 1 or 2 ohms at various frequencies and the MC252 has the output current reserve to drive them. The MC252 has main filter capacitors that guarantee an excellent signal to noise ratio and the energy storage necessary for the wide dynamic range that “Digital Audio” demands.

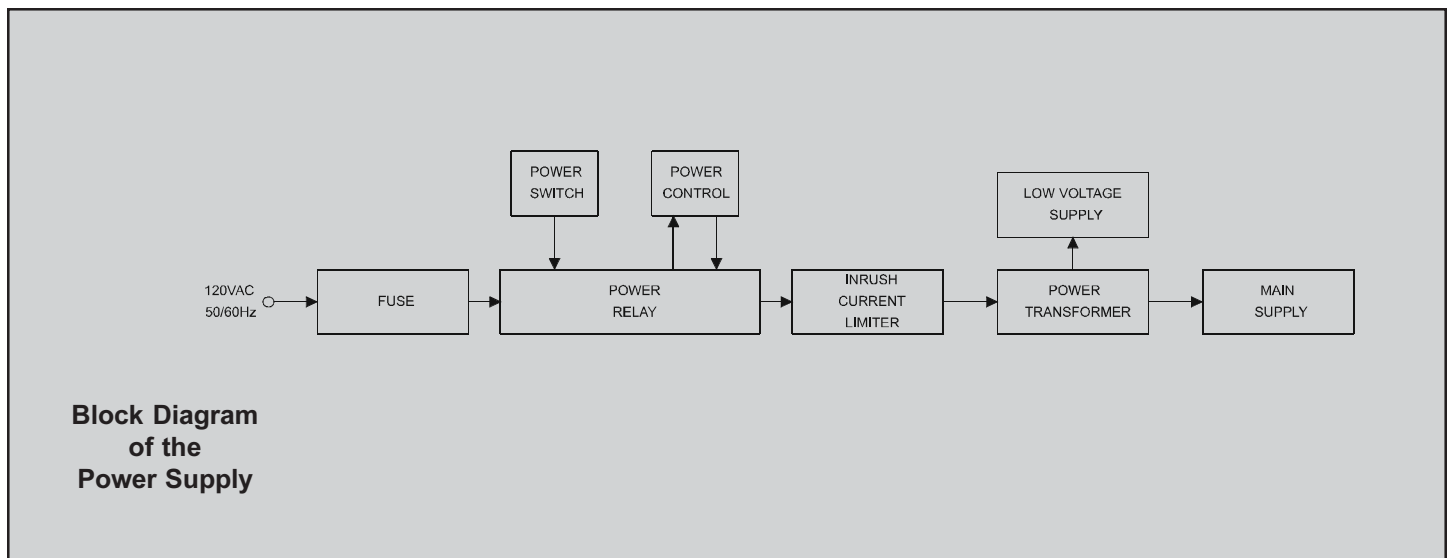
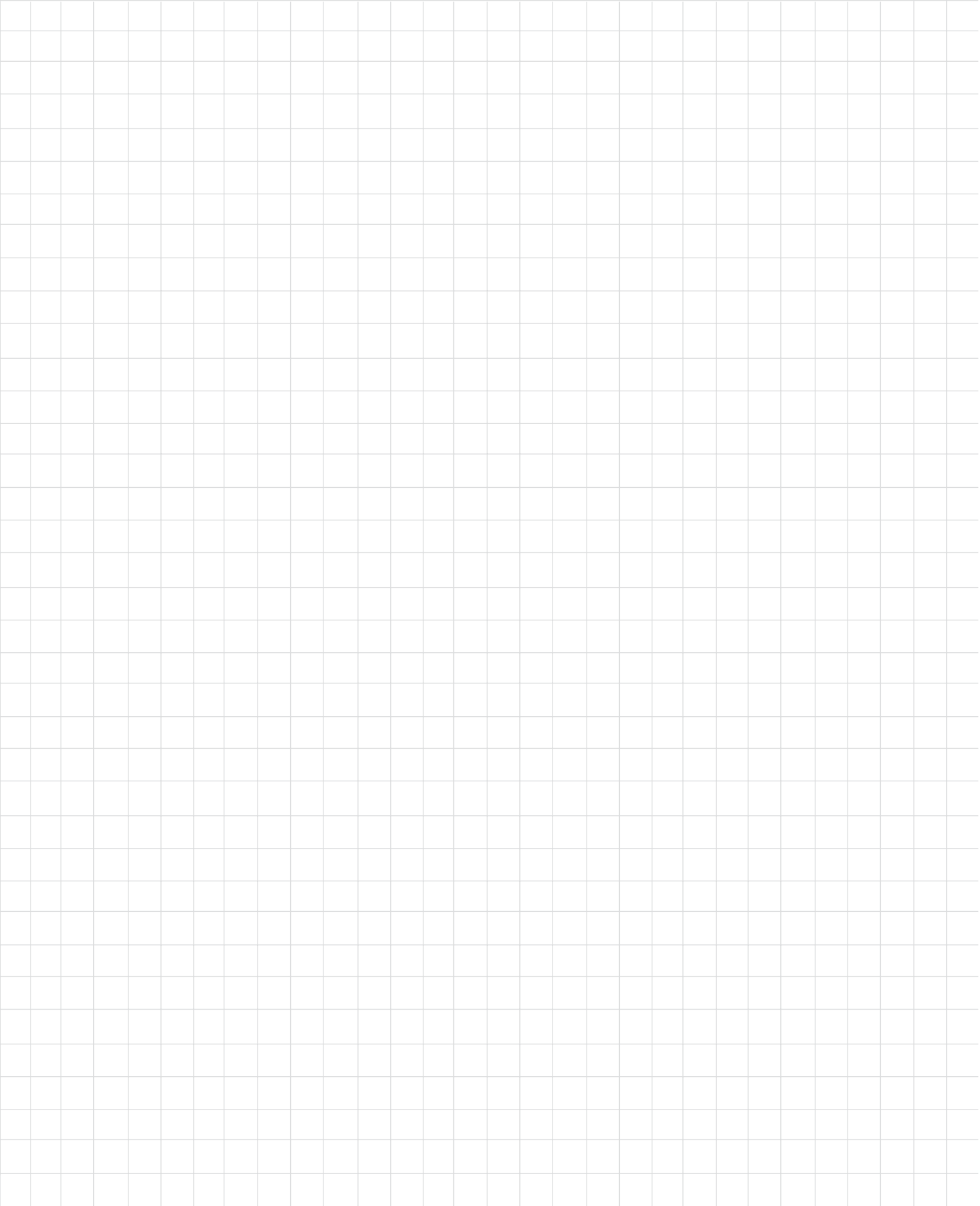
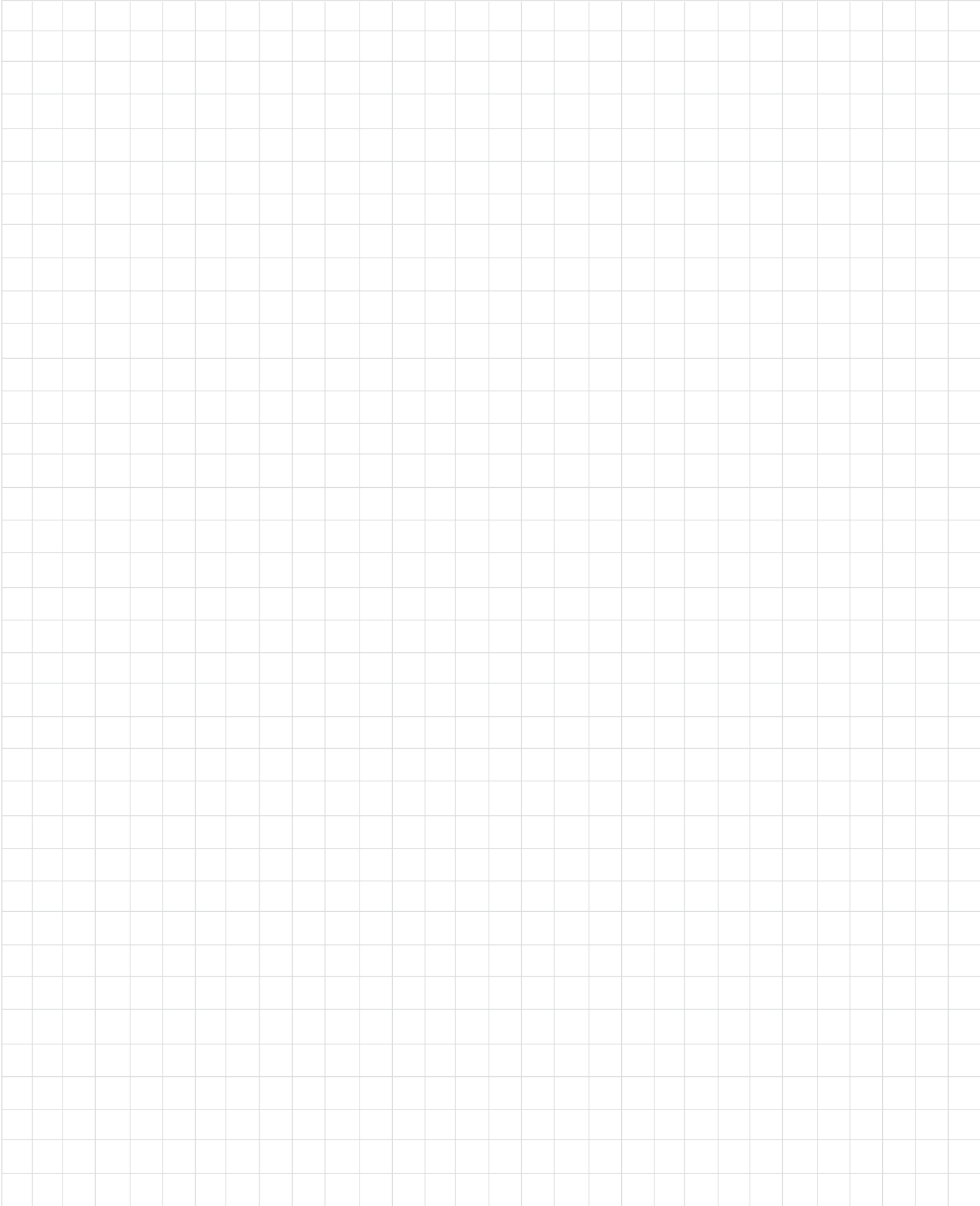

Figure 20





Specifications

Power Output Stereo

Minimum sine wave continuous average power output per channel, all channels operating is:

250 watts into 2 ohm load

250 watts into 4 ohm load

250 watts into 8 ohm load

Power Output Mono Bridged

Minimum sine wave continuous average power output is:

500 watts into 4 ohm load

500 watts into 8 ohm load

500 watts into 16 ohm load

Power Output Mono Bi-Amp (Parallel)

Minimum sine wave continuous average power output is:

500 watts into 1 ohm load

500 watts into 2 ohm load

500 watts into 4 ohm load

Output Load Impedance

2, 4 or 8 ohms (Stereo Mode)

1, 2, 4, 8 or 16 ohms (Mono Modes)

Rated Power Band

20Hz to 20,000Hz

Total Harmonic Distortion

Maximum Total Harmonic Distortion at any power level from 250 milliwatts to rated power output is 0.005%

Intermodulation Distortion

Maximum Intermodulation Distortion if instantaneous peak output per channel does not exceed twice the rated output, for any combination of frequencies from 20Hz to 20,000Hz, with all channels operating is 0.005%

Dynamic Headroom

2.0dB

Frequency Response

+0, -0.25dB from 20Hz to 20,000Hz

+0, -3dB from 10Hz to 100,000Hz

Sensitivity

1.6 Volts Unbalanced Input

3.2 Volts Balanced Input

A-Weighted Signal To Noise Ratio

112dB below rated output

Input Impedance

10,000 ohms Unbalanced Inputs

20,000 ohms Balanced Inputs

Wide Band Damping Factor

Greater than 40

Power Requirements

100 Volts, 50/60Hz at 8.0 amps

110 Volts, 50/60Hz at 7.2 amps

120 Volts, 50/60Hz at 6.6 amps

220 Volts, 50/60Hz at 3.3 amps

230 Volts, 50/60Hz at 3.3 amps

240 Volts, 50/60Hz at 3.3 amps

Note: Refer to the rear panel of the MC252 for the correct voltage.

Overall Dimensions

Width is 17-1/2 inches (44.45cm)

Height is 9-7/16 inches (23.97cm) including feet

Depth is 14-13/16 inches (37.62cm) including the Front Panel and Knobs

Weight

94.5 pounds (42.87 kg) net, 108.5 pounds (49.22 kg) in shipping carton

Packing Instructions

In the event it is necessary to repack the equipment for shipment, the equipment must be packed exactly as shown below. It is very important that the four plastic feet are attached to the bottom of the equipment. Three #10 x 2-1/2 inch screws and washers must be used to fasten the unit securely to the bottom pad and shipping skid. This will ensure the proper equipment location on the bottom pad. Failure to do this will result in shipping damage.

Use the original shipping carton and interior parts only if they are all in good serviceable condition. If a shipping carton or any of the interior part(s) are needed, please call or write Customer Service Department of McIntosh Laboratory. Please see the Part List for the correct part numbers.

Quantity	Part Number	Description
1	034256	Shipping carton only
2	034250	Foam end cap
1	034198	Inner carton top
1	034199	Inner carton bottom
1	034188	Foam pad
1	034037	Inner carton pad
1	033699	Shipping skid
7	017218	Plastic foot
4	100159	#10-32 x 3/4" Machine screw
2	104083	#10 x 7/16" Flat washer
3	101204	#10 x 2-1/2" Wood screw
3	104033	#10 x 1-3/4" Flat washer

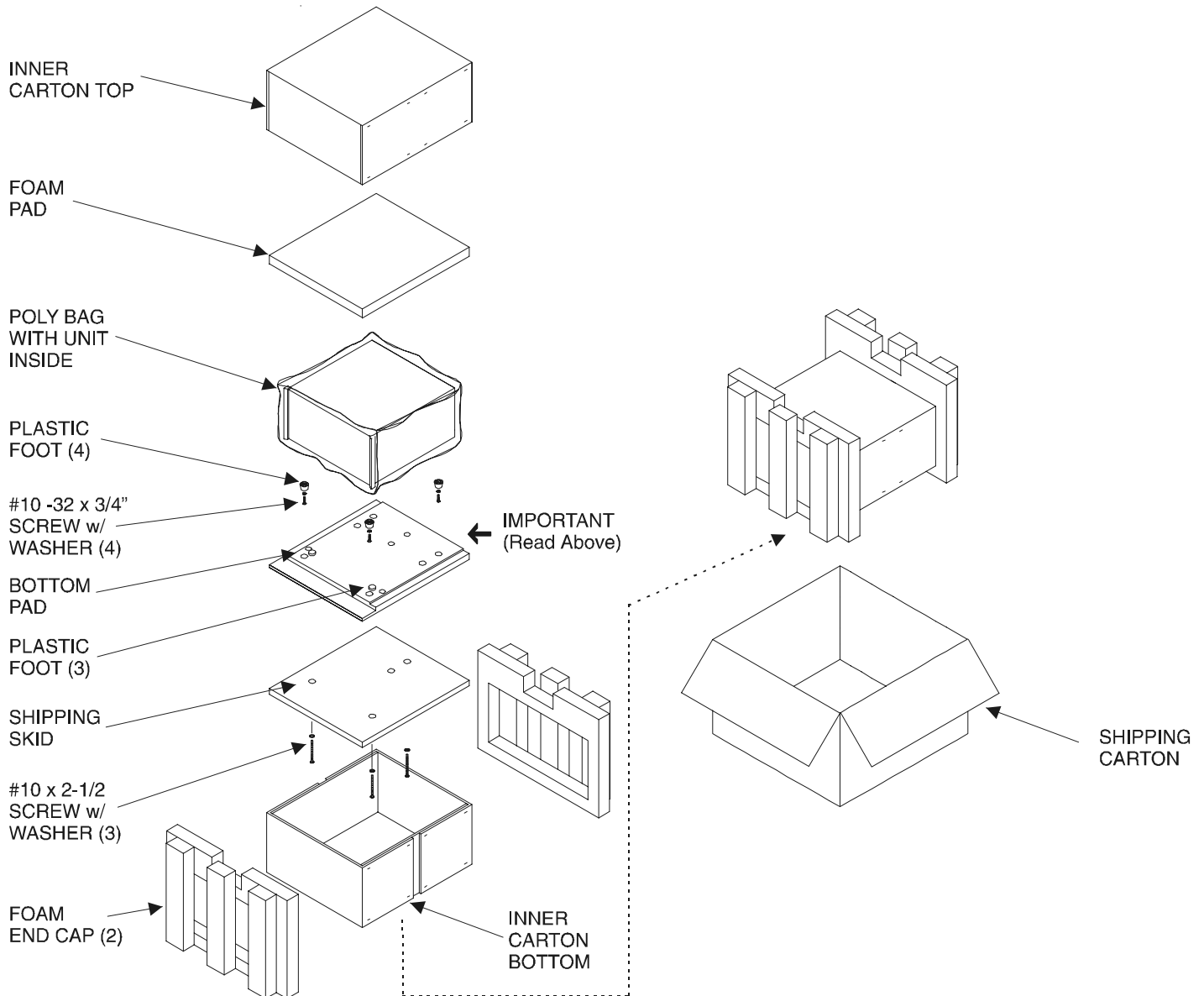



McIntosh Laboratory, Inc.
2 Chambers Street
Binghamton, NY 13903

The continuous improvement of its products is the policy of McIntosh Laboratory Incorporated who reserve the right to improve design without notice.

Printed in the U.S.A.

McIntosh Part No. 040815

Free Manuals Download Website

<http://myh66.com>

<http://usermanuals.us>

<http://www.somanuals.com>

<http://www.4manuals.cc>

<http://www.manual-lib.com>

<http://www.404manual.com>

<http://www.luxmanual.com>

<http://aubethermostatmanual.com>

Golf course search by state

<http://golfingnear.com>

Email search by domain

<http://emailbydomain.com>

Auto manuals search

<http://auto.somanuals.com>

TV manuals search

<http://tv.somanuals.com>