



**MEADE**  
www.meade.com

**TELESTAR INSTRUCTION MANUAL**  
**60mm | 2.4" Altazimuth Refracting Telescope**



**60AZ-A2**

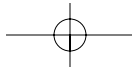
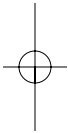
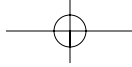

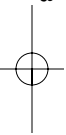

## INTRODUCTION

Your telescope is an excellent beginner's instrument, and is designed to observe objects in the sky and also on land. It can be your personal window on the universe or allows you to intimately study the behavior of nesting birds on a distant hillside.

The telescope is shipped with the following parts:

- Optical tube
- Aluminum tripod with an accessory tray
- Two 1.25" eyepieces: MA25mm (28X), MH9mm
- 2x 1.25" Barlow lens
- Diagonal mirror
- 5x24mm viewfinder with bracket
- Telescope mount
- Hardware used in the assembly:
  - 3 bolts (2" long) with wing nuts and washers
  - 3 screws (1 1/2" long) with nuts

The tube has a focal length of 700mm, and its objective lens has a diameter of 60mm. The lens diameter is one of the most important pieces of information about the

telescope. The size of the objective lens determines how much detail you will be able to see in your telescope. The focal length will help later on to calculate magnification.

Setting up your telescope involves these simple steps:

- Assemble your tripod
- Attach the accessory tray
- Attach the optical tube to the mount
- Attach the viewfinder
- Attach the diagonal mirror and eyepiece
- Align the viewfinder

Study the the picture on the next page and become acquainted with the parts of your telescope. Then proceed to "Assemble your Tripod..."

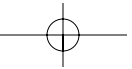
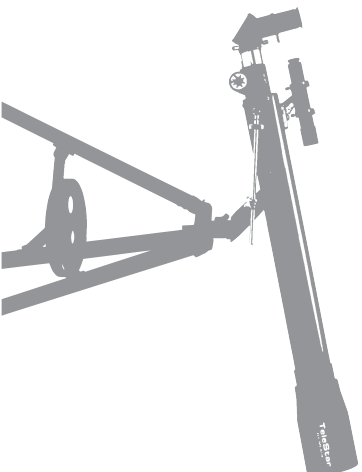
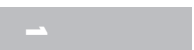
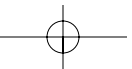

**2**

**FIGURE 1**

**Figure 1:** TelesStar 60AZ-A2 Altazimuth Refracting Telescope  
 Accessory Tray Mounting Bolt Hole  
 Tripod Leg  
 Viewfinder Assembly

1. Eyepiece
2. Viewfinder (see Inset C)
3. Viewfinder alignment screws (see Inset C)
4. Optical tube assembly
5. Vertical lock knobs
6. Horizontal lock knob
7. Tripod legs
8. Leg brace supports
9. Leg brace
10. Mount base attachment
11. Tripod attachment bolts and wing nuts
12. Accessory tray mounting bolt hole (see Inset A)
13. Diagonal mirror
14. Objective lens cell
15. Focuser drawtube and thumbscrews
16. Altitude rod slow motion fine adjustment control
17. Altitude rod
18. Altazimuth mount
19. Adjustable sliding center leg extension (see Inset B)
20. Tripod leg lock thumbscrew (see Inset B)
21. Dew shield/lens shade
22. Front lens cap
23. Focusing knob
24. Viewfinder bracket (see Inset C)
25. Viewfinder bracket mounting thumbscrews (see Inset C)
26. Accessory tray

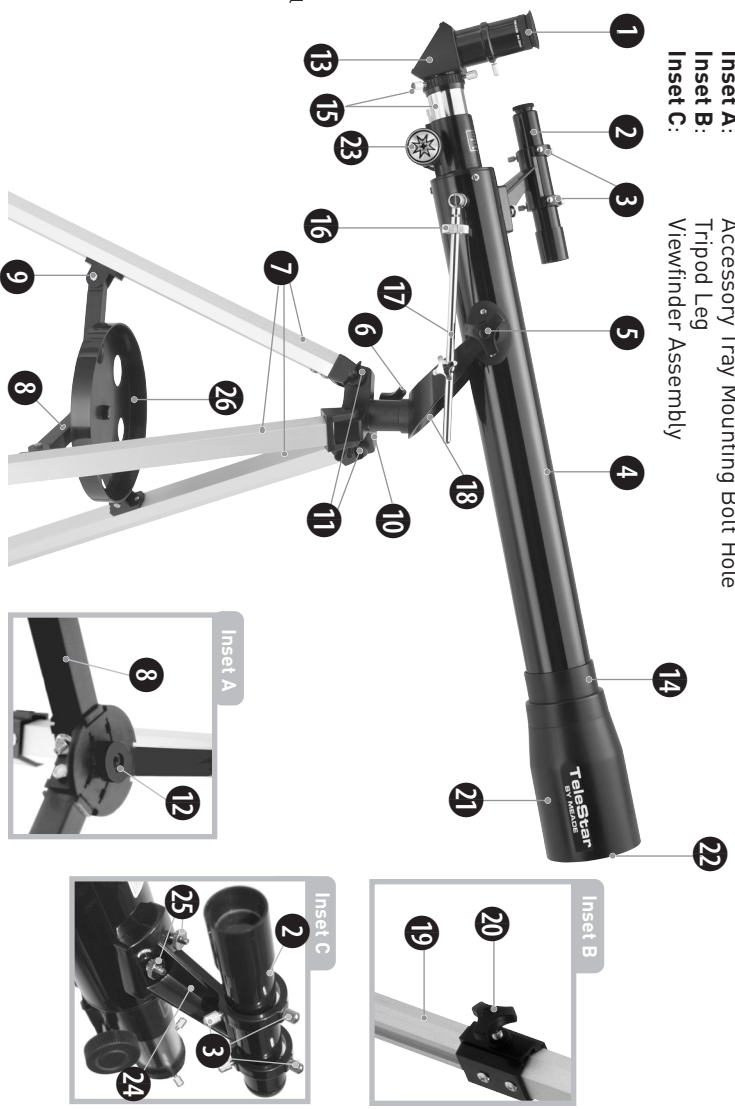

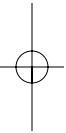

### ASSEMBLE YOUR TRIPOD

The tripod is the basic support for your telescope. Its height may be adjusted so that you can view comfortably.

**Note: Number in brackets, e.g., (3), refer to Fig. 1.**

1. Make sure that as you attach the legs (7) to the mount that the leg braces (9) are facing inward.
2. Line up the holes at the top of one of the legs with the holes in the mount (10). See Fig. 2.
3. Thread one of the 2-inch bolts through the holes.
4. Thread a wingnut over the bolt and hand-tighten to a firm feel.
5. Attach the remaining two legs to the mount in the same manner.
6. Spread the legs out evenly apart.
7. Set the height of your tripod:
  - a. Rotate and loosen the leg lock thumbscrew (20) to unlock the leg lock.
  - b. Slide the inner portion of the leg (19) in or out to the desired length.
  - c. Rotate and tighten the leg lock thumbscrew to relock the leg lock.

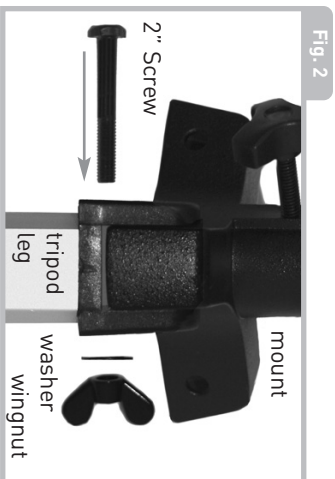
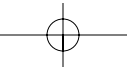

- d. Repeat for the other two legs.

### ATTACH THE ACCESSORY TRAY

The tray helps stabilize the tripod and is also a convenient holder of eyepieces and other Meade accessories, such as the Barlow lens.

1. Line up the holes at the end of one of the leg brace supports (8) with the holes in one of the leg braces (9).
2. Thread one of the one-half inch bolts through the holes.
3. Thread a hex nut over the end of the bolt.
4. Finger-tighten the bolt and hex nut. See Fig. 3.

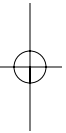

3

5. Repeat with the two other leg braces.

6. Thread the accessory tray (26) over the center mounting bolt to a firm feel.

### ATTACH THE OPTICAL TUBE TO THE MOUNT

The optical tube gathers distant light which is focused in the eyepiece.

1. Remove the two lock knobs (5) from the optical tube.
2. Slide the altitude rod (17) into the hole in the altitude adjustment control. Tighten to a firm feel. See Fig. 4.
3. Place the optical tube (4) between the forks of the mount, oriented as shown in Fig. 4.

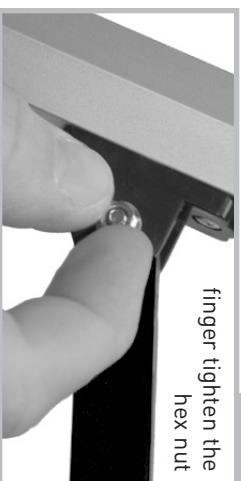
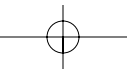

4. Thread a lock knob (5) through each of the holes in the forks of the mount and tighten to a firm feel.

#### ATTACH THE VIEWFINDER

An eyepiece (1) has a narrow field of view. A viewfinder (2) has a wider field of view, which makes it easier to locate objects. The 5x24mm viewfinder has crosshairs to make it easier to line up more precisely with a target.

- Note the two thumbscrews (25) threaded

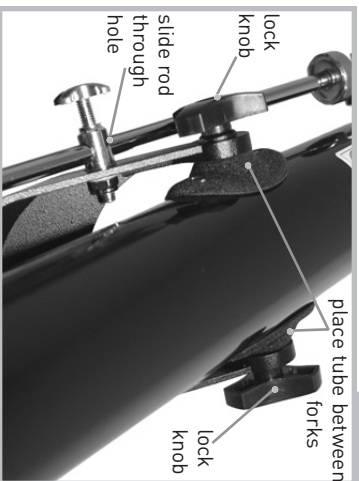

Fig. 4

- onto two bolts on the optical tube. Remove the thumbscrews from the tube.
- Line up the two holes on the viewfinder bracket over the two bolts. Slide the bracket over the bolts. See Fig. 1, inset C.
  - Replace the thumbscrews onto the bolts and tighten to a firm feel.

#### ATTACH THE DIAGONAL MIRROR AND EYEPIECE

The diagonal mirror reflects the light from the optical tube to a more comfortable viewing position.

- Slide the diagonal mirror (13) into the focuser drawtube (15).
- Tighten the drawtube thumbscrew to hold the diagonal mirror securely.
- Slide the MA 25mm eyepiece (1) into diagonal mirror.
- Tighten the diagonal mirror thumbscrew to hold the eyepiece securely.

#### ALIGN THE VIEWFINDER

Perform the first part of this procedure during the daytime and the last step at night.

- Point the telescope at an easy-to-find land object such as the top of a telephone

pole or a distant mountain or tower. Look through the eyepiece in the diagonal mirror and turn the focuser knob (23) until the image is sharply focused. Center the object precisely in the eyepiece's field of view.

- Look through the viewfinder. Turn one or more of the viewfinder's alignment screws (3) until the crosshairs are precisely over the same object as you centered in the eyepiece.
- Check this alignment at night on a celestial object, such as the Moon or a bright star, and use the viewfinder's alignment screws to make any necessary refinements.



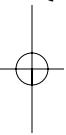

### TO MOVE THE TELESCOPE

Your telescope is altazimuth mounted. Altazimuth is just a complicated way of saying that your telescope moves up and down and from side to side. Other telescopes may be mounted in different ways.

1. Slightly loosen one of the star-shaped altitude control knobs (5). Loosening this knob allows you to move the telescope up and down.
2. Slightly loosen the horizontal lock knob (6). Loosening this lock allows the telescope to be moved from side to side.
3. Once an object is found, re-tighten the control knobs. You can then use the slow motion control (16) to make smooth and precise movements as you can follow (or "track") an object as it moves in the eyepiece.

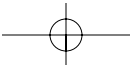

### SUN WARNING NEVER USE YOUR TELESCOPE TO LOOK AT THE SUN!

LOOKING AT OR NEAR THE SUN WILL CAUSE INSTANT AND IRREVERSIBLE DAMAGE TO YOUR EYE. EYE DAMAGE IS OFTEN PAINLESS, SO THERE IS NO WARNING TO THE OBSERVER THAT DAMAGE HAS OCCURRED UNTIL IT IS TOO LATE. DO NOT POINT THE TELESCOPE OR ITS VIEWFINDER AT OR NEAR THE SUN. DO NOT LOOK THROUGH THE TELESCOPE OR ITS VIEWFINDER AS IT IS MOVING. CHILDREN SHOULD ALWAYS HAVE ADULT SUPERVISION WHILE OBSERVING.

### THE MOST IMPORTANT RULE

We have one very important rule that you should always follow when using your telescope:

## Have Fun!

Have a good time when you're observing. You may not know everything that there is to know about a telescope or what all the sights in the universe are, but that's OK. Just point and observe at first.

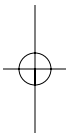

You will enjoy your telescope even more as you learn more about it. But don't be scared off by difficult terms or complicated procedures. Don't panic! Just relax and enjoy your scope.

You will begin to grow and learn more about astronomy the more you observe. Go to the library and read some books about the stars and planets. Read about astronomers of old. Many of them had telescope no bigger than the one you are using right now. Galileo, who is one of the first astronomers to use a telescope, discovered four of the moons of Jupiter with a telescope about the same size as yours (and his didn't even focus very well!).

### THE MEADE 4M COMMUNITY

You haven't just bought a telescope, you have embarked on an astronomy adventure that never ends. Share the journey with others by accepting your free membership in the 4M community of astronomers.

Go to [www.Meade4M.org](http://www.Meade4M.org) to activate your membership today.

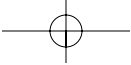

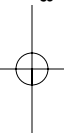

6

**OBSERVING**

**Observe during the daytime:** Try out your telescope during the daytime at first. It is easier to learn how it operates and how to observe when it is light.

**Pick out an easy object to observe:** A distant mountain, a large tree, a lighthouse or skyscraper make excellent targets. Point the optical tube so it lines up with your object.

**Unlock the lock knobs:** To move the telescope, you will need to unlock the horizontal (6) and vertical (5) lock knobs (just

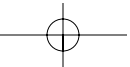
**TOO MUCH POWER?**

Can you ever have too much power? If the type of power you're referring to is eyepiece magnification, yes you can! The most common mistake of the beginning observer is to "overpower" a telescope by using high magnifications which the telescope's aperture and atmospheric conditions cannot reasonably support. Keep in mind that a smaller, but bright and well-resolved image is far superior to one that is larger, but dim and poorly resolved. Powers above 400x should be employed only under the steadiest atmospheric conditions.

rotate to unlock or lock; when locking, only tighten to a "firm feel," do not overtighten).

**Use the viewfinder:** If you have not done so, align the viewfinder (2) with the telescope's eyepiece (1) as described earlier.

Look through the viewfinder until you can see the object. It will be easier to locate an object using the viewfinder rather than locating with the eyepiece. Line up the object in the viewfinder's crosshairs.

**Look through the eyepiece:** Once you have the object lined up in the viewfinder, look through the optical tube's eyepiece. If you have aligned your viewfinder, you will you see the object in your eyepiece.

**Focus:** Look through the eyepiece and practice focusing on the object you have chosen.

**Try out the coarse and fine adjustment controls:** Practice using the fine adjustment control (16) to move the telescope. These can come in very handy, especially when you wish to move the telescope in very small (fine control) steps.

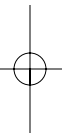

**Observe the Moon:** When you feel comfortable with the viewfinder, the eyepieces, the locks and the adjustment controls, you will be ready to try out the telescope at night. The Moon is the best object to observe the first time you go out at night. Pick a night when the Moon is a crescent. No shadows are seen during a full Moon, making it appear flat and uninteresting.

Look for different features on the Moon. The most obvious features are craters. In fact you can see craters within craters. Some craters have bright lines about them. These are called rays and are the result of material thrown out of the crater when it was struck by a colliding object. The dark areas on the Moon are called maria and are composed of lava from the period when the Moon still had volcanic activity. You can also see mountain ranges and fault lines on the Moon.

Use a neutral density filter (often called a "moon filter") when observing the Moon. Neutral density filters are available from Meade as an optional accessory and enhance contrast to improve your observation of lunar features.

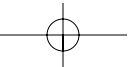



Spend several nights observing the Moon. Some nights, the Moon is so bright that it makes other objects in the sky difficult to see. These are nights that are excellent for lunar observation.

**Observe the Solar System:** After observing the Moon, you are ready to step up to the next level of observation, the planets. There are four planets that you can easily observe in your telescope: Venus, Mars, Jupiter and Saturn.

Nine planets (maybe more!) travel in a fairly circular pattern around our Sun. Any system of planets orbiting one or more stars is called a solar system. Our Sun, by the way, is a single, yellow dwarf star. It is average as far as stars go and is a middle aged star.

Beyond the planets are clouds of comets, icy planetoids and other debris left over from the birth of our sun. Recently astronomers have found large objects in this area and they may increase the number of planets in our solar system.

The four planets closest to the Sun are rocky and are called the inner planets. Mercury,

Venus, Earth and Mars comprise the inner planets. Venus and Mars can be easily seen in your telescope.

Venus is seen before dawn or after sunset, because it is close to the Sun. You can observe Venus going through crescent phases. But you cannot see any surface detail on Venus because it has a very thick atmosphere of gas.

When Mars is close to the Earth, you can see some details on Mars, and sometimes even Mars' polar caps. But quite often, Mars is further away and just appears as a red dot with some dark lines crisscrossing it.

Jupiter, Saturn, Uranus, Neptune and Pluto comprise the outer planets. These planets, except for Pluto, are made mostly of gases and are sometimes called gas giants. If they had grown much bigger, they may have become stars. Pluto is made mostly of ice.

Jupiter is quite interesting to observe. You can see bands across the face of Jupiter. The more time you spend observing these bands, the more detail you will be able to see.

One of the most fascinating sights of Jupiter are its moons. The four largest moons are called the Galilean moons, after the astronomer Galileo, who observed them for the first time.

If you've never watched the Galilean moons in your telescope before, you're missing a real treat! Each night, the moons appear in different positions around the Jovian sky. This is sometimes called the Galilean dance. On any given night, you might be able to see the shadow of a moon on the face of Jupiter, see one moon eclipse another or even see a moon emerge from behind Jupiter's giant disk. Drawing the positions of the moons each night is an excellent exercise for novice astronomers.



Any small telescope can see the four Galilean moons of Jupiter (Fig. 5), plus a few others, but how many moons does Jupiter actually have?

**S**

No one knows for sure! Nor are we sure how many Saturn has either. At last count, Jupiter had over 60 moons, and held a small lead over Saturn. Most of these moons are very small and can only be seen with very large telescopes.

Probably the most memorable sight you will see in your telescope is Saturn. Although you may not see many features on the surface of Saturn, its ring structure will steal your breath away. You will probably be able to see

a black opening in the rings, known as the Cassini band.

Saturn is not the only planet that has rings, but it is the only set of rings that can be seen with a small telescope. Jupiter's rings cannot be seen from Earth at all—the Voyager spacecraft discovered the ring after it passed Jupiter and looked back at it. It turns out, only with the sunlight shining through them, can the rings be seen. Uranus and Neptune also have faint rings.

Optional color filters help bring out detail and contrast of the planets. Meade offers a line of inexpensive color filters.

#### What's Next? Beyond the Solar System:

Once you have observed our own system of planets, it's time to really travel far from home and look at stars and other objects.

You can observe thousands of stars with your telescope. At first, you may think stars are just pinpoints of light and aren't very interesting. But look again. There is much information that is revealed in stars.

The first thing you will notice is that not all

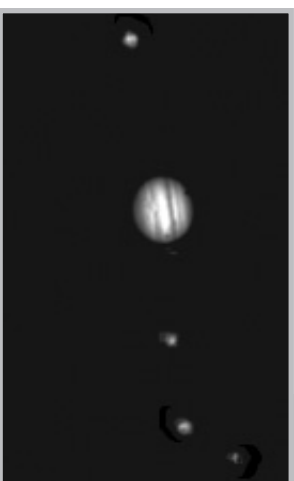

Fig. 5

stars are the same colors. See if you can find blue, orange, yellow, white and red stars. The color of stars sometimes can tell you about the age of a star and the temperature that they burn at.

Other stars to look for are multiple stars. Very often, you can find double (or binary) stars, stars that are very close together. These stars orbit each other. What do you notice about these stars? Are they different colors? Does one seem brighter than the other?

Almost all the stars you can see in the sky are part of our galaxy. A galaxy is a large



Saturn's rings of ice, dust and gas are huge and small at the same time. The main rings are so large they could almost reach from the earth to the moon. But they are only about a half of a mile (just a few city blocks) wide.

grouping of stars, containing millions or even billions of stars. Some galaxies form a spiral (like our galaxy, the Milky Way) and other galaxies look more like a large football and are called elliptical galaxies. There are many galaxies that are irregularly shaped and are thought to have been pulled apart because they passed too close to—or even through—a larger galaxy.

You may be able to see the Andromeda galaxy and several others in your telescope. They will appear as small, fuzzy clouds. Only very large telescope will reveal spiral or elliptical details.

You will also be able to see some nebulas with your scope. Nebula means cloud. Most nebulas are clouds of gas. The two easiest to see in the Northern Hemisphere are the Orion nebula during the winter and the Trifid nebula during the summer. These are large clouds of gas in which new stars are being born. Some nebulas are the remains of stars exploding. These explosions are called supernovas.

When you become an advanced observer you can look for other types of objects such as

asteroids, planetary nebula and globular clusters. And if you're lucky, every so often a bright comet appears in the sky, presenting an unforgettable sight.

The more you learn about objects in the sky, the more you will learn to appreciate the sights you see in your telescope. Start a notebook and write down the observations you make each night. Note the time and the date.

Use a compass to make a circle, or trace around the lid of a jar. Draw what you see in your eyepiece inside the circle. The best exercise for drawing is to observe the moons of Jupiter every night or so. Try to make Jupiter and the moons approximately the same size as they look in your eyepiece. You will see that the moons are in a different position every night. As you get better at drawing, try more challenging sights, like a crater system on the moon or even a nebula.

Go your library or check out the internet for more information about astronomy. Learn about the basics: light years, orbits, star colors, how stars and planets are formed, red shift, the big bang, what are the different

kinds of nebula, what are comets, asteroids and meteors and what is a black hole. The more you learn about astronomy, the more fun, and the more rewarding your telescope will become.

#### **SOME OBSERVING TIPS**

**Eyepieces:** Always begin your observations using the 25mm low-power eyepiece. The 25mm eyepiece delivers a bright, wide field of view and is the best to use for most viewing conditions. Use the high-power 9mm eyepiece to view details when observing the Moon and planets. If the image become fuzzy, switch back down to a lower power.

#### **SURF THE WEB**

- The Meade 4M Community:  
<http://www.meade4m.org>
- Sky & Telescope:  
<http://www.skyandtelescope.com>
- Astronomy:  
<http://www.astronomy.com>
- Astronomy Picture of the Day:  
<http://antwrp.gsfc.nasa.gov/apod>
- Photographic Atlas of the Moon:  
[http://www.ipi.ursa.edu/research/lunar\\_orbiter](http://www.ipi.ursa.edu/research/lunar_orbiter)
- Hubble Space Telescope Public Pictures:  
<http://oposite.stsci.edu/pubinfo/pictures.html>

Changing eyepieces changes the power or magnification of your telescope.

By the way, you might have noticed something strange when you looked through your eyepiece. Although the image is right-side up, it is reversed. That means reading words can be a problem. But it has no affect on astronomical objects. If you wish to have a fully corrected image, check out Meade's optional Erecting Prism in the Optional Accessory section.

**Barlow lens:** You can also change magnification by using a Barlow. Remove the

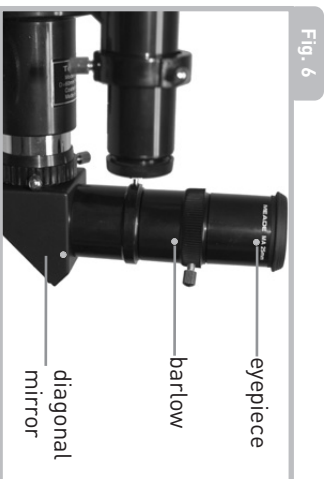

eyepiece from the diagonal mirror and slide in the Barlow. And then place the eyepiece into the Barlow. Tighten the thumbscrews to secure the Barlow lens and the eyepiece in place. The Barlow lens included with your telescope doubles the power of your telescope. See Fig. 6.

Meade offers a complete line of eyepieces for your telescope. Most astronomers have four or five low-power and high power eyepieces to view different objects and to cope with different viewing conditions.

**Objects move in the eyepiece:** If you are observing an astronomical object (the Moon,

Fig. 6

Star charts and planetariums are useful for a variety of reasons. In particular, they are a great aid in planning a night of celestial viewing.

**STAR CHARTS**

A wide variety of star charts are available in books, in magazines, on the internet and on CD Roms. Meade offers Autostar Suite™ software. Contact your local Meade dealer or Meade's Customer Service department for more information.

*Astronomy and Sky and Telescope* magazines print star charts each month for up-to-the-minute maps of the heavens.

a planet, star, etc.) you will notice that the object will begin to move slowly through the telescopic field of view. This movement is caused by the rotation of the Earth and makes an object move through the telescope's field of view. To keep astronomical objects centered in the field, simply move the telescope on one or both of its axes—vertically and/or horizontally as needed—try using the telescopes coarse and fine adjustment controls. At higher powers, astronomical objects will seem to move through the field of view of the eyepiece more rapidly.

Place the object to be viewed at the edge of the field and, without touching the telescope, watch it drift through the field to the other side before repositioning the telescope so that the object to be viewed is again placed at the edge of the field, ready to be further observed.

**Vibrations:** Avoid touching the eyepiece while observing through the telescope. Vibrations resulting from such contact will cause the image to move. Avoid observing sites where vibrations cause image movement (for example, near railroad

tracks). Viewing from the upper floors of a building may also cause image movement.

**Let your eyes "dark-adapt":** Allow five or ten minutes for your eyes to become "dark adapted" before observing. Use a red-filtered flashlight to protect your night vision when reading star maps, or inspecting the telescope. Do not use use a regular flashlight or turn on other lights when observing with a group of other astronomers. You can make your own red filtered flashlight by taping red cellophane over a flashlight lens.

**Viewing through windows:** Avoid setting up the telescope inside a room and observing through an opened or closed window pane. Images may appear blurred or distorted due to temperature differences between inside and outside air. Also, it is a good idea to allow your telescope to reach the ambient [surrounding] outside temperature before starting an observing session.

**When to observe:** Planets and other objects viewed low on the horizon often lack sharpness—the same object, when observed higher in the sky, will appear sharper and have greater contrast. Try reducing power

(change your eyepiece) if your image is fuzzy or shimmers. Keep in mind that a bright, clear, but smaller image is more interesting than a larger, dimmer, fuzzy one. Using too high a power eyepiece is one of the most common mistakes made by new astronomers.

**Dress Warm:** Even on summer nights, the air can feel cool or cold as the night wears on. It is important to dress warm or to have a sweater, jacket, gloves, etc., nearby.

**Know your observing site:** If possible, know the location where you will be observing. Pay attention to holes in the ground and other obstacles. Is it a location where wild animals, such as skunks, snakes, etc., may appear? Are there viewing obstructions such as tall trees, street lights, headlights and so forth? The best locations are dark locations, the darker the better. Deep space objects are easiest to see under dark skies. But it is still possible to observe even in a city.

**Surf the Web and visit your local library:** The Internet contains a huge amount of astronomical information, both for children

and adults. Check out astronomy books from your library. Look for star charts—these are available on a monthly basis in *Astronomy* and *Sky and Telescope* magazines.

**HAVE A GOOD TIME, ASTRONOMY IS FUN!**

**SPECIFICATIONS**

- Optical tube focal length ..... 700mm
- Objective lens diameter ..... 60mm (2.4")
- Focal ratio ..... f/11.7
- Mounting type ..... Altazimuth

**ASTRONOMY RESOURCES**

- The Meade 4M Community  
6001 Oak Canyon, Irvine, CA 92618
- Astronomical League  
Executive Secretary  
5675 Real del Norte, Las Cruces, NM 88012
- The Astronomical Society of the Pacific  
390 Ashton Avenue, San Francisco, CA 94112
- The Planetary Society  
65 North Catalina Avenue, Pasadena, CA 91106
- International Dark-Sky Association, Inc.  
3225 N. First Avenue, Tucson, AZ 85719-2103



## 12

### What do the specifications mean?

Optical tube focal length is simply a measurement of the length of the optical tube. In other words, this is the distance light travels in the telescope before being brought to focus in you eyepiece. Your tube is 700mm long.

Objective lens diameter is how big the lens is on your scope. Telescopes are always described by how large their objective lens is. Your telescope is 60mm or 2.4 inches. Other telescopes are 90mm, 8 inches, 16 inches, or even 3 feet in diameter. The Hubble Telescope's objective lens has a diameter of 2.4 meters (that's 7.8 feet across!).

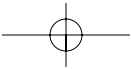

The focal ratio helps determine how fast the photographic speed of a telescope is. The lower the focal ratio number, the faster the exposure. f/5 is faster than f/10. The faster the ratio, the faster exposure time is needed when a camera is hooked up to the telescope. Your telescope has slower focal ratio at f/11.7. Sometimes, astronomers use focal reducers to make slow exposure telescopes have faster focal ratios.

Altaz mounting simply means your telescope moves up and down (altitude or "alt"), and side to side, (azimuth or "az"). Other mounting configurations are available for other telescopes, such as equatorial mounting.

### USE THE SPECIFICATIONS TO CALCULATE THE MAGNIFICATION OF YOUR EYEPIECE

The power of a telescope is how much it magnifies objects. Your 25mm eyepiece magnifies an object 28 times. Your 9mm eyepiece magnifies objects 78 times.

But if you obtain other eyepieces, you can calculate how much magnification they have with your telescope. Just divide the focal

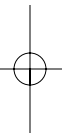

length of the telescope by the focal length of the eyepiece.

$$\begin{array}{r} \text{Focal Length of the Telescope} \\ \div \\ \text{Focal Length of the Eyepiece} \\ = \\ \text{Magnification} \end{array}$$

Look at the specifications. You will see that the focal length of your scope is 700mm. Let's say that you have obtained a 13mm eyepiece. You can tell that what the focal length of your eyepiece is as it is always printed on the side of an eyepiece. Divide:  $700 \div 13$ , which equals 53.8. Round this off to the nearest whole number and your new eyepiece magnifies objects 54 times.

If you use your Barlow lens with one of your eyepieces, it doubles the magnification of your eyepiece. Other types of Barlows can triple or further increase the power of an eyepiece. To find out how much your magnification is when you use a Barlow, multiply your eyepiece's magnification by two.

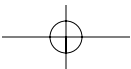





Eyeiece's magnification x 2 =

Magnification with a 2X Barlow lens

Your 25mm low-power eyepiece magnifies an object 28 times. Multiply 28 by 2 and you get 56 times magnification with your Barlow.

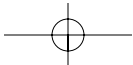

**It's worth repeating:** Keep in mind that a bright, clear, but smaller image is more interesting than a larger, dimmer, fuzzy one. Using too high a power eyepiece is one of the most common mistakes made by new astronomers. So don't think that higher magnification is necessarily better—quite often the best view is with lower magnification value!

**TAKING CARE OF YOUR TELESCOPE**

Your telescope is a precision optical instrument designed for a lifetime of rewarding viewing. It will rarely, if ever, require factory servicing or maintenance. Follow these guidelines to keep your telescope in the best condition:

- Avoid cleaning the telescope's lenses. A little dust on the front surface of the telescope's correcting lens will not cause

loss of image quality.

- When absolutely necessary, dust on the front lens should be removed with very gentle strokes of a camel hair brush or blown off with an ear syringe (available at most pharmacies).
- Fingerprints and organic materials on the front lens may be removed with a solution of 3 parts distilled water to 1 part isopropyl alcohol. You may also add 1 drop of biodegradable dishwashing soap per pint of solution. Use soft, white facial tissues and make short, gentle strokes. Change tissues often.

**CAUTION:** Do not use scented or lotioned tissues or damage could result to the optics. DO NOT use a commercial photographic lens cleaner.

**OPTIONAL ACCESSORIES**

**#928 45° Erecting Prism (1.25 O.D.):**

Correctly orients the telescopic image during terrestrial observing and yields an image position at a 45° angle to the main telescope tube, resulting in a more comfortable observing position in most cases.

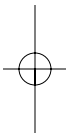

15

**Additional Eyepieces (1.25" barrel diameter):**

For higher or lower magnifications with the telescopes that accommodate 1.25" eyepieces, Meade 3-element Modified Achromatic eyepieces, available in a wide variety of sizes, provide a high level of image resolution and color correction at an economical price. Also, at slightly higher prices, Meade 4-element Series 4000 Super Plüßel eyepieces yield wider fields of view with excellent edge-of-field corrections and are available in a range of focal lengths including 6.4, 9.7, 12.4, 15, 20, 26, 32, and 40mm.

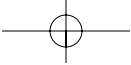

**JOIN AN ASTRONOMY CLUB, ATTEND A STAR PARTY**

One of the best ways to increase your knowledge of astronomy is to join an astronomy club. Check your local newspaper, school, library, or telescope dealer/store to find out if there's a club in your area.

Many groups also hold regularly scheduled Star Parties at which you can check out and observe with many different telescopes and other pieces of astronomical equipment. Magazines such as *Sky and Telescope* and *Astronomy* print schedules for many popular Star Parties around the United States and Canada.



**14**  
Contact your Meade Dealer or see the Meade catalog for more information. Visit us on the web at: [www.meade.com](http://www.meade.com).

#### MEADE CUSTOMER SERVICE

If you have a question concerning your telescope, call Meade Instruments Customer Service Department at (800) 626-3233. Customer Service hours are 8:00AM to 5:00PM, Pacific Time, Monday through Friday. Write or call the Meade Customer Service Department first, before returning the telescope to the factory, giving full particulars as to the nature of the problem, as well as your name, address, and daytime telephone number. The great majority of servicing issues can be resolved by telephone, avoiding return of the telescope to the factory.

#### MEADE LIMITED WARRANTY

Every Telesar telescope, spotting scope, and telescope accessory is warranted by Meade Instruments Corporation ("Meade") to be free of defects in materials and workmanship for a period of ONE YEAR from the date

of original purchase in the U.S.A. Meade will repair or replace a product, or part thereof, found by Meade to be defective, provided the defective part is returned to Meade, freight-prepaid, with proof of purchase. This warranty applies to the original purchaser only and is non-transferable. Meade products purchased outside North America are not included in this warranty, but are covered under separate warranties issued by Meade international distributors.

**RG# Number Required:** Prior to the return of any product or part, a Return Goods Authorization (RG#) number **must** be obtained from Meade by writing, or by calling (800) 626-3233. Each returned part or product must include a written statement detailing the nature of the claimed defect, as well as the owner's name, address, and phone number.

This warranty is not valid in cases where the product has been abused or mishandled, where unauthorized repairs have been attempted or performed, or where depreciation of the product is due to normal wear-and-tear. Meade specifically disclaims special, indirect, or consequential damages

or lost profit which may result from a breach of this warranty. Any implied warranties which cannot be disclaimed are hereby limited to a term of one year from the date of original retail purchase.

This warranty gives you specific rights. You may have other rights which vary from state to state.

Meade reserves the right to change product specifications or to discontinue products without notice.

This warranty supersedes all previous Meade product warranties.

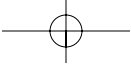
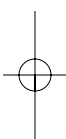
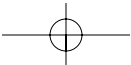





**OBSERVATION LOG**



OBSERVER: \_\_\_\_\_

OBJECT NAME: \_\_\_\_\_

DATE & TIME OBSERVED: \_\_\_\_\_

CONSTELLATION: \_\_\_\_\_

EYEPiece SIZE: \_\_\_\_\_

SEEING CONDITIONS:     EXCELLENT     GOOD     POOR

NOTES: \_\_\_\_\_

\_\_\_\_\_

\_\_\_\_\_

\_\_\_\_\_



\_\_\_\_\_  
\_\_\_\_\_  
\_\_\_\_\_

(SAVE ORIGINAL - BE SURE TO MAKE COPIES)

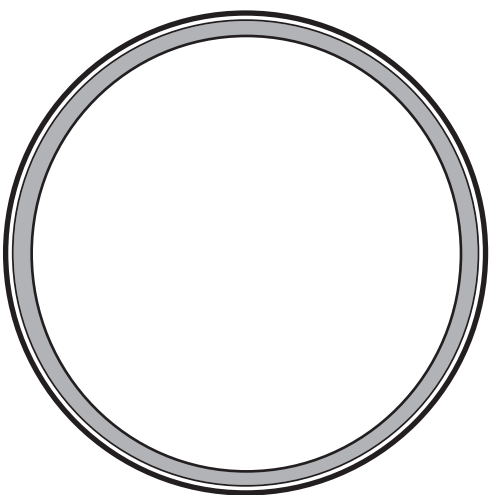
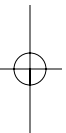

**DRAWING OF IMAGE**

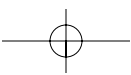



### OBSERVATION LOG



OBSERVER: \_\_\_\_\_

OBJECT NAME: \_\_\_\_\_

DATE & TIME OBSERVED: \_\_\_\_\_

CONSTELLATION: \_\_\_\_\_

EYEPiece SIZE: \_\_\_\_\_

SEEING CONDITIONS:     EXCELLENT     GOOD     POOR

NOTES: \_\_\_\_\_

\_\_\_\_\_

\_\_\_\_\_

\_\_\_\_\_



\_\_\_\_\_  
\_\_\_\_\_  
\_\_\_\_\_

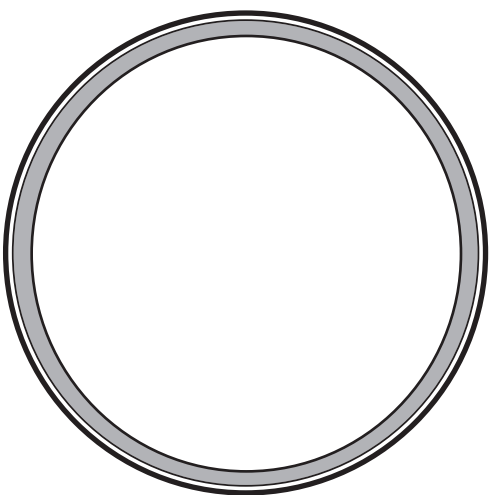
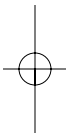

DRAWING OF IMAGE

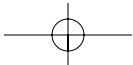

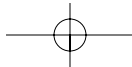
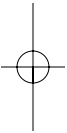
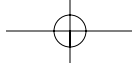

**1-800**  
**626-3233**

**Meade Instruments Corporation**  
**6001 Oak Canyon, Irvine, California**

**92618**

**[www.meade.com](http://www.meade.com)**



## Free Manuals Download Website

<http://myh66.com>

<http://usermanuals.us>

<http://www.somanuals.com>

<http://www.4manuals.cc>

<http://www.manual-lib.com>

<http://www.404manual.com>

<http://www.luxmanual.com>

<http://aubethermostatmanual.com>

Golf course search by state

<http://golfingnear.com>

Email search by domain

<http://emailbydomain.com>

Auto manuals search

<http://auto.somanuals.com>

TV manuals search

<http://tv.somanuals.com>