



**MEADE®**

## **Instruction Manual**

**6" LS-6 ACF / 6" LS-6 SC and  
8" LS-8 ACF / 8" LS-8 SC Telescopes  
with AutoStar III Hand Controller  
Firmware version 1.3 and higher**



**INDEX** →



## **WARNING!**

**Never use a Meade® LS™ Telescope to look at the Sun!** Looking at or near the Sun will cause instant and irreversible damage to your eye. Eye damage is often painless, so there is no warning to the observer that damage has occurred until it is too late. Do not point the telescope at or near the Sun. Do not look through the telescope or Red-Dot Finder as it is moving. Children should always have adult supervision while observing.



# CONTENTS

## Introduction

The most sophisticated and easiest to use telescope ever .....	3
--	---

## Getting Started

### Assembling the Telescope and using LightSwitch

Assembling the tripod .....	5
Mounting the tripod .....	6
Installing the batteries .....	6
Using an AC Adapter or DC Power Cord .....	6
Attaching Accessories .....	7
Telescope is now Fully Assembled .....	7
Powering up the Telescope - LightSwitch Technology™ .....	8

### AutoStar III Handbook – Basic Usage

Basics .....	9
Navigating the Menus .....	9
Changing Modes .....	10
Menu Mode .....	10
Scope Info Mode .....	10
Sky Map Mode .....	10
Shortcuts .....	10

## LS Key Features

### Telescope

Key Features identified on the Telescope .....	11
Key Features Explained .....	13
Using the Red-Dot Finder .....	15
Adjusting the Red-Dot Finder .....	15

### Optional MEADE® Accessories

Choosing Eyepieces .....	16
Meade Series 4000 Super Plössl Eyepieces .....	16
Meade Series 5000 Premium Eyepieces .....	17
Power Supplies .....	18
Imagers and related Accessories .....	18

### AutoStar III Handbook

Buttons, Display and their functions .....	19
Menu Tree .....	23
Guided Tour Menu .....	24
Object Menu .....	24
Event Menu .....	25
Take Picture Menu .....	25
Utilities Menu .....	26
Setup Menu .....	27

### Advanced LS Features

Two Star Alt Az Alignment .....	29
One Star Alt Az Alignment .....	30
Finding objects not in the database .....	30

© The name “Meade,” “AutoStar,” “LightSwitch” and the Meade logo are trademarks registered with the U.S. Patent and Trademark Office and in principal countries throughout the world. “SmartFinder,” “Deep Sky Imager,” “LS”, and “Tonight’s Best” are trademarks of Meade Instruments Corporation.

Patents:

US 7,277,223, US 7,079,317, US 7,092,156

US 6,304,376, US 7,221,527, US 6,922,283

US 6,392,799

© 2009 Meade Instruments Corporation.

Landmarks .....	30
Observing Satellites .....	31
Terrestrial Observing .....	32

## Maintenance

Basic Maintenance .....	33
Collimation .....	33
Inspecting the Optics .....	35
Gauging the Movement of the Telescope .....	35
Updating Your LS Firmware .....	35
SD Card for Updates and Image Storage .....	36

## Meade Customer Service

How to get in contact .....	36
-----------------------------	----

## Appendix A:

Training the Drive .....	37
--------------------------	----

## Appendix B:

Creating User Objects .....	38
-----------------------------	----

## Appendix C:

Basic Astronomy .....	39
-----------------------	----

## Specifications

LS-6 ACF: .....	41
LS-6 SC: .....	42
LS-8 ACF .....	43
LS-8 SC .....	44

## Declarations

FCC: .....	45
WEEE: .....	46

## Meade Warranty

One Year Limited Warranty .....	Back Cover
---------------------------------	------------

### BATTERY SAFETY INSTRUCTIONS:

- Always purchase the correct size and grade of battery: 8 x “C-type” Alkaline batteries (ANSI 14A, 14AC/ IEC LR14).
- Always replace the whole set of batteries at one time, taking care not to mix old and new ones, or batteries of different types.
- Clean the battery contacts and also those of the device prior to battery installation.
- Ensure the batteries are installed correctly with regard to polarity (+ and -).
- Remove batteries from equipment which is not to be used for an extended period of time.
- Remove used batteries promptly.
- Never attempt to recharge primary batteries as this may cause leakage, fire, or explosion.
- Never short-circuit batteries as this may lead to high temperatures, leakage, or explosion.
- Never heat batteries in order to revive them.
- Remember to switch off devices after use.
- Keep batteries out of the reach of children; small batteries may be ingested.
- Seek medical advice immediately if a battery has been swallowed.

**Caution: If batteries or parts are swallowed, see a doctor immediately.**



# INTRODUCTION

## The LS-6 and LS-8 LightSwitch® Telescopes

*The most sophisticated and easiest to use telescopes ever*

Congratulations on receiving your new **LS** telescope. You'll find that this telescope system has all you need to explore the Universe we live in. Meade's concept was to create a telescope that would be simple enough for anyone to use, yet capable enough for the experienced amateur to stretch their knowledge and skills. With the most advanced and complete list of features of any telescope, you will have plenty of room to learn and expand your interest in astronomy and not out grow your telescope. Here are a few of the features that set the **Meade LS** telescope system apart from all others.

- Ease of Use:** **LightSwitch** Technology is the ultimate in easy setup. Using a combination of optical, mechanical and electronic sensors, LightSwitch delivers a telescope ready to start observations without any input from the user.
- Optics:** Your choice of optical systems to meet your needs. Meade's Schmidt-Cassegrain (SC) optics give you high performance for the best possible price. Water-white glass, Ultra-High Transmission Coatings (UHTC) and oversized, thermally-stable Pyrex® primary mirrors provide spectacular viewing experience not available on comparable competitors' telescopes. Advanced Coma-Free takes all of the features of our SC models and then ups the ante. ACF gives a flatter, coma-free field of view with pinpoint images all the way to the edge of the field, equaling Ritchey-Crétien performance. ACF is the perfect solution for the serious astroimager or visual astronomer looking for observatory-class optics.
- Mechanics:** Strong and stable aluminum castings with large precision worm-gear drives in both axes for smooth tracking with low periodic error.
- Computer:** **AutoStar III** handbox gives you complete control of your **LS** system from the palm of your hand. With a database of nearly 100,000 objects, you will never run out of things to explore.
- Multimedia:** The **Astronomer Inside™** provides audio and video descriptions of the objects you are viewing with a wealth of information along with guided tours of the best objects in your sky.
- Imaging:** The built-in **ECLIPS™** CCD Module enables you to take wide-field digital images of the sky, view them real time with an attached video monitor and save them to an SD card without using an external computer.

If you are like us, you can't wait to get outside under a dark sky to try out your new **LS** telescope. We have provided a Getting Started Guide that will get you up and running in the shortest amount of time possible. After your first experience, please sit down with this manual and read about all the advanced features that are available to you with this telescope system. We are confident that the **LS** will keep you fascinated with the Universe and entertained for many years to come.

Clear Skies,

The people at Meade



← INDEX →

## GETTING STARTED

You may want to perform the LS assembly indoors in the light so that you become familiar with the parts and operation before moving the telescope outside into the dark for observing. This Getting Started Guide assumes you are too impatient to read the entire manual first and want to use your new telescope as quickly as possible. Just follow the simple steps below and you will be up and running before you know it.

**1** It is best to set up the telescope in twilight or before sunset the first time you use it. Take the telescope and tripod outside. Set the telescope in a large open area where you can see lots of sky. Don't setup right next to a building or a wall. Also try to stay away from large metal objects like a car or a metal fence. Make sure the ground is stable and is approximately level. It is best to set up the scope away from bright nighttime lighting. Bright lights will spoil your night vision and impede your ability to see the sky. Additionally, it will take the telescope longer to align itself if there are too many bright lights around.

### Assembling the Tripod



**2** Remove the field tripod from the shipping carton. Stand the tripod vertically with the tripod feet down and with the tripod still fully collapsed. Grasp two of the tripod legs and, with the full weight of the tripod on the third leg, gently pull the legs apart to a fully open position.



**3** Thread in two lock-knobs on each leg (six total) near the foot of each tripod leg. Use the lock-knobs to vary the height of the inner, extendible tripod leg sections. Tighten the locks to a firm feel only; do not overtighten.

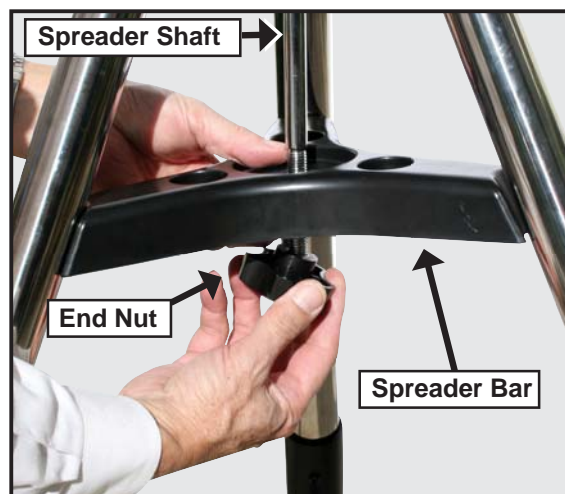

**4** Remove the end nut from the spreader shaft and slide the spreader in between the telescope legs. Attach the end nut and hand tighten until the telescope legs are held snugly in the most spread position. Position the tripod where you want the telescope to be and check that the top of the tripod is approximately level.



## Mounting the Telescope

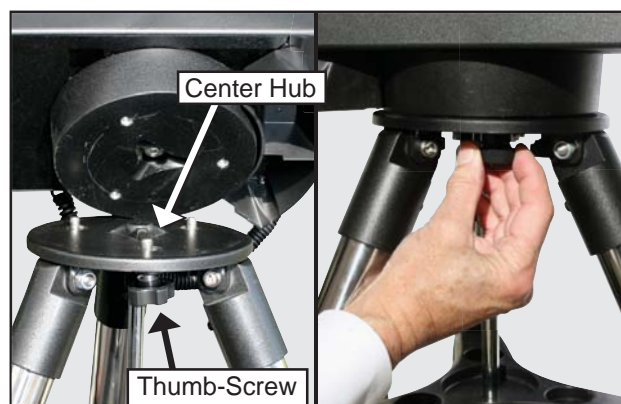

**5** Take the LS Telescope from its packaging and place the entire telescope onto the top of the tripod head. Rotate the telescope head slowly until you feel the scope register on the center hub of the tripod head. Carefully screw the three attachment thumb-screws on the bottom of the plate to the base of the tripod. Hand tighten the screws so the telescope cannot spin or wobble on the tripod head.

## Installing the Batteries



**6** Remove the end cover from the battery compartment exposing the battery tray. Carefully slide the battery tray out until it reaches its end stop. Insert 8 (user supplied) Alkaline "C" batteries into the battery compartment. Take care that the batteries + and - ends are as indicated in the battery holder.

Slide the battery compartment back into the telescope and re-attach the battery compartment cover.

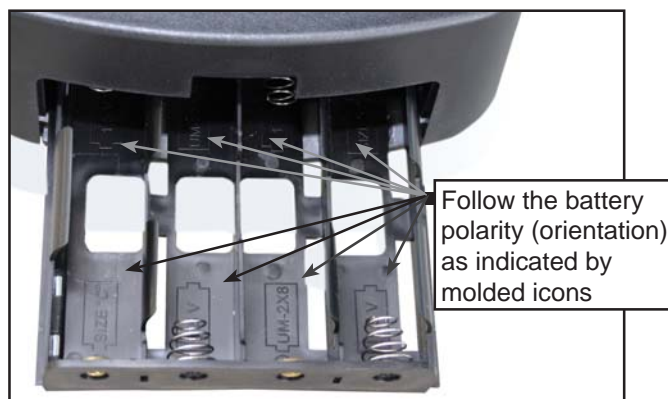

**CAUTION:** Use care to install batteries as indicated by the battery compartment. Follow battery manufacturer's precautions. Do not install batteries backwards or mix new and used batteries. Do not mix battery types. If these precautions are not followed, batteries may explode, catch fire, or leak. Improperly installed batteries void your Meade warranty. Always remove the batteries if they will not be used for a long period of time.

## Using an AC Adapter or DC Power Cord



**7** Use only the optional Meade Universal AC Power Adapter (part number 07584 for North America or 07584F for 220v foreign) with your LS telescope when connecting to AC power. It is specifically selected to provide the quality voltage and current required to power and protect the electronics in the telescope. Power adapters from other manufactures may cause damage and void your warranty.

Plug the AC plug into a household AC socket and the DC plug into the 12v DC jack on the telescope panel.

For external DC power use the optional #607 DC Power Cord (part number 07043) to connect to an automotive 12v DC accessory socket.

## Attaching Accessories



**8** Be sure the telescope master power switch is in the off position. Remove the AutoStar III handset and the coiled interface cable from the packing materials. Plug one end into the HNDBX port of the control panel and plug the other end into the Handbox port on the AutoStar III handset.

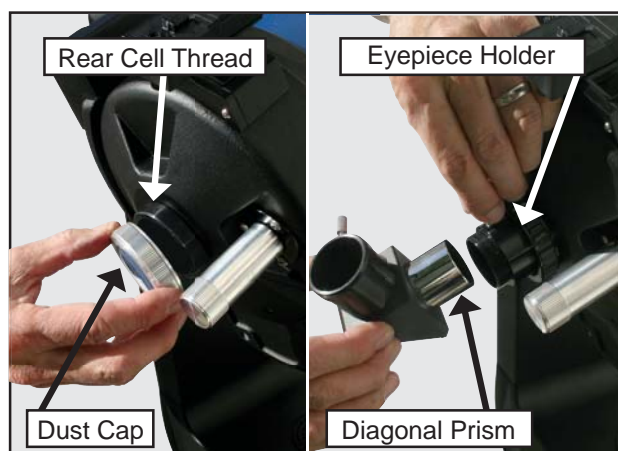

**9** Remove the dust cap from the rear cell of the telescope. Thread the 1.25" eyepiece holder onto the rear cell thread. Slide the diagonal prism into the eyepiece holder and lock in place by turning the thumbscrew to a firm feel. Place the Super Plössl 26mm eyepiece into the diagonal prism and tighten the diagonal prism thumbscrew to a firm feel only.

## Your Telescope is now Fully Assembled



**10** Now remove the dust cover from the front of the telescope tube. Be careful not to touch the glass lens.



**11** Next remove the dust cap from the ECLIPS CCD Module and put it in a safe place.



## Powering Up The Telescope

**12** When night has fallen, approximately 1 hour after sunset, turn on your telescope. Flip the LightSwitch on the telescope fork arm to the ON (1) position. The copyright message lights on LS's LCD display.

**13** After the telescope powers on, you will hear a brief introductory message. You can press the **"MEDIA"** key to bypass the introduction if you like.

If you have attached a video cable from the Video Out connection on the telescope to the composite video input of a NTSC TV monitor, you will also see graphics accompanying the telescope introduction.

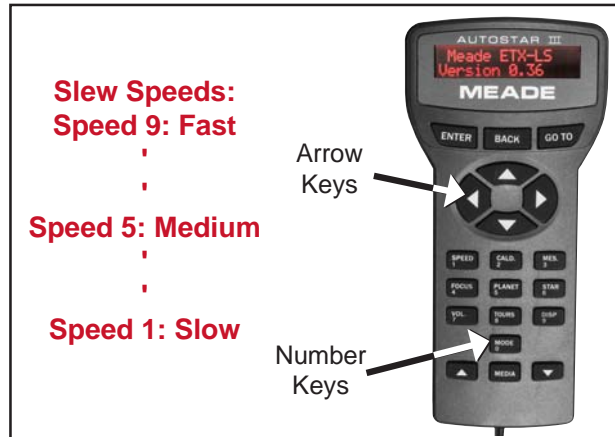

**14** At the end of this message, the telescope will immediately start its LightSwitch Automatic Alignment procedure. It will take about five to ten minutes for the telescope to orient and align itself. Once it has completed the alignment the handbox screen will display "Alignment Successful".

## LS TIPS

### "MODE" Key

The **"MODE"** Key cycles the telescope through its three different modes; Menu Mode, Info Mode and Skymap Mode.

During most telescope operations, pressing the **"MODE"** key will stop the current operation.

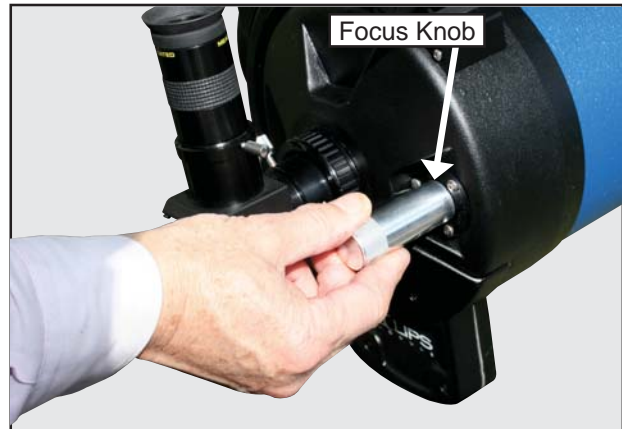

**15** At this point look through the eyepiece of the telescope. You should see some light from the final alignment star but it is probably out of focus. Adjust the focus using the knob on the back of the telescope until you get a sharply focused star image.

**16** Press the **"Tours/8"** key on the AutoStar and select the "Tonight's Best" tour by pressing the Scroll Down arrow key at the bottom of the AutoStar. Press **"ENTER"** to start the tour of the best objects visible in your sky right now. You will hear a brief introduction to the tour and then the first object will be shown on the second line of the AutoStar display. If you press **"ENTER"** to select this object, you will hear a description of the object. If you press the GoTo key, the telescope will move (slew) to put the object in the eyepiece so you can view it directly. To move to the next object, press the **"BACK"** key and then the Scroll Down key to move through the available objects in the tour. Press **"ENTER"** to select the displayed object. To exit the tour, press the **"Mode"** key.

**17** When you are finished observing for the night, replace the dust cover over the end of the telescope and the dust cap on the lens of the ECLIPS Module. Select "Shutdown" from the main top level menu. After the telescope has moved to its storage position and the AutoStar displays "Turn Off Telescope", flip the LightSwitch to the OFF (0) position.



# AUTOSTAR III HANDBOX - BASIC USAGE

Now that you have successfully setup and used your LS telescope, it's time for more information about all the capabilities of this amazing optical system.

The first step is to familiarize yourself with the AutoStar III handbox operation. The largest keys on the keypad are the motion control keys. Most of the time, these keys allow you to move, or slew, your telescope both up and down and right and left. Press them now and see how the telescope moves in response to the keys. When the telescope initially starts up the scope is set to move at its fastest speed. While this is great for getting close to the area you want to see, it is really too fast to get anything positioned into the eyepiece. For that reason, the LS has 9 distinct speeds.



To change the telescope's speed, press the *1/SPEED* key. You can now select a speed with the scroll up and down small arrow keys on the bottom of the hand control. When you have the desired speed selected, press the “ENTER” key. Alternatively, when the speed selection screen is showing, you can just press a number 1-9 to select a speed quickly, where 1 is the slowest and 9 is the fastest.

Take a moment and try move the scope around at some different speeds.

## Navigating the Menus

Now that you are starting to get comfortable with the basics, lets learn some new keys. The most important keys for navigating the menus on you telescope are the keys along the top and bottom rows of your AutoStar. The two small arrows on the bottom of the key pad, allow you to scroll through the possible menu selections. The menu line is at the top of the handbox display and the top of the video monitor if connected. The second line of the hand control display has the current active menu item. If you are looking at a connected video display, you will see more menu choices and the active selection will be highlighted.

### Key Functions

- “BACK” - return to previous menu.
- “ENTER” - select or confirm entry.
- “GO TO” - Slew to currently selected object.
- “SPEED” - Adjust Slew Speed.
- “FOCUS” - Optional Electronic focuser. Motion pad controls focuser. Up/Down scrolls focus speed.
- “VOL.” - Up/Dn adjusts media volume.
- “DISP” - Control Display contrast, brightness.
- “MODE” - Cycles thru Menu -> Scope info -> SkyMap -> Menu and aborts current operation.
- “MEDIA” - Toggles media on and off.
- “CALD” - Lookup Caldwell Objects
- “MES” - Look up Messier Objects
- “PLANETS” - Look up planets in our solar system
- “STAR” - Look up bright stars

The “**ENTER**” and “**BACK**” buttons on the top of the display let you move up and down the menu tree. When you press “**ENTER**” you will select the current active menu choice. Pressing “**BACK**” will move you up the menu tree. To get us to the top of the menu tree, press “**BACK**” until “Select Item” is displayed on line 1 of the display. This is the top level menu. Use the scroll keys to navigate through the choices until you find “Objects”. Press “**ENTER**”. Now you should be able to navigate to “Constellations”. Once you are there press “**ENTER**” again. Now press “**ENTER**” to select “Andromeda”.

The telescope will now start to tell you the story of Andromeda. You can listen to the whole story, or press the “**MEDIA**” key to skip the story and more menu choices will appear. If you want to go from the menu, “**BACK**” to the story, just press the “**MEDIA**” key again to restart the story.

A complete tree of the available menu choice is contained in figure 6 on page 23 of the manual.

## CHANGING MODES

### Menu Mode

Up till now we have been exploring the **Menu Mode**. The handbox has several other modes in addition to simple menu navigation. You will notice the “**0**” key is also labelled “**MODE**”. Pressing “**MODE**” allows you to cycle through the telescopes three modes.

### Scope Info Mode

Press “**MODE**” now. In Scope Info Mode the scroll keys allow you to look at the current time, date, and location where the telescope is pointing along with other key values about the status of your telescope.

### Sky Map Mode

Press “**MODE**” again. The hand control display will show “Sky Map FOV=45”. In sky map mode an attached video monitor shows a planetarium-like map of the sky in the area where your telescope is pointed. Use the motion keys to move the scope and notice how the sky display changes as you move the scope. You can zoom the display in or out by pressing the scroll up and scroll down buttons.

## Shortcuts!

Now lets look at the numeric keypad. Each of the number keys does two things. If the telescope is requesting input, the number keys allow you to enter digits into the telescope. When you are navigating the menus they act as shortcuts. Their assignments are as follows:

1. “**SPEED**”: We have already used this key. It allows you to change the slew speed of the telescope.
2. “**CALDWELL**”: Let’s you look up members of a popular group of bright deep sky objects that make up the Caldwell Catalog.
3. “**MESSIER**”: Let’s you look up some of the most famous bright deep sky objects that make up the Messier Catalog
4. “**FOCUS**”: If you have the optional electric focuser on you your telescope you can press this key to go to focus mode. Now the arrow keys will move the focus in or out.
5. “**PLANETS**”: Lets you directly lookup a planet.
6. “**STARS**”: Lets you directly lookup a bright stars.
7. “**VOLUME**”: Gives you quick access to the telescope audio volume control
8. “**TOURS**”: Lets you directly select a guided tour. *(note: to exit a tour at any time hit the “MODE” Key.)*

Now spend a little quality time with the telescope to get comfortable navigating its features. When you are comfortable, it is time to go out and explore the night sky.

# LS KEY FEATURES



- ① Diagonal Eyepiece Holder
- ② Diagonal Prism
- ③ 1.25" Eyepiece Holder
- ④ Eyepiece Holder Thumb Screw
- ⑤ Eyepiece
- ⑧ Single Fork Arm Mount

- ⑪ Telescope Input/Output Panel
- ⑬ ON/OFF LightSwitch
- ⑮ ECLIPS CCD Module
- ⑰ Red Dot Finder Alignment Screws
- ⑱ Handbox Storage Cradle

Figure 1: LS Telescope



Figure 2: LS Right Side

- 6 Diagonal Thumbscrew
- 7 Optical Tube Assembly (OTA)
- 9 Focus Knob
- 10 Integrated Sensor Module
- 12 Dust Cover
- 14 Battery Compartment
- 16 Red Dot Finder
- 19 Mini SD Card Slot
- 20 USB-A for Future Expansion
- 21 USB-B connector to PC
- 22 Video Output
- 23 Audio Output
- 24 Electronic Focuser Jack
- 25 Handbox (HNDBX) Port
- 26 12v Power Input



Figure 3: LS Front

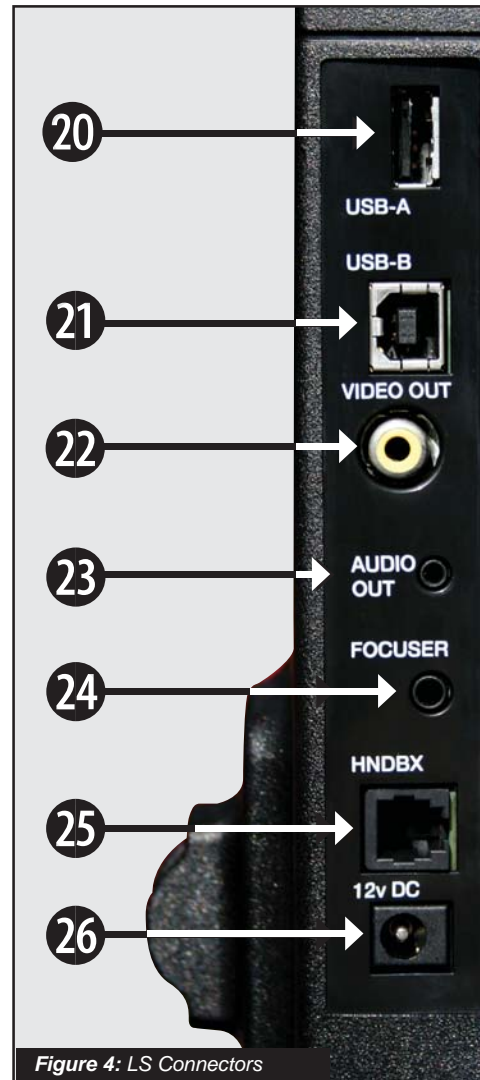

Figure 4: LS Connectors



- 1 **Diagonal Holder:** Holds the eyepiece in place.
- 2 **Diagonal Prism:** provides a more comfortable right angle viewing position. Slide the diagonal prism directly into the eyepiece holder (Fig. 1, 3).
- 3 **1.25" Eyepiece Holder**
- 4 **Eyepiece Holder Thumb Screw**
- 5 **Eyepiece:** Place the Super Plössl 26mm eyepiece into the 90° diagonal prism (Fig. 1, 4) and tighten in place with the thumbscrews. The eyepiece magnifies the image collected in the optical tube.
- 6 **Diagonal Eyepiece Holder Thumbscrew:** Tightens the eyepiece in place. Tighten to a firm feel only.
- 7 **Optical Tube Assembly (OTA):** The main optical component that gathers the light from distant objects and brings this light to a focus for examination through the eyepiece.
- 8 **Single Fork Arm Mount:** Holds the optical tube in place and moves it to find and track objects.
- 9 **Focus Knob:** Moves the telescope's primary mirror in a finely-controlled motion to achieve precise image focus. The LS telescope can be focused on objects from a distance of about 25 ft. to infinity. Rotate the focus knob counterclockwise to focus on distant objects, and clockwise to focus on nearby objects.
- 10 **Integrated Sensor Module:** Receives location and time information transmitted from Global Positioning System (GPS) satellites. Determines north and level positions.
- 11 **Telescope Input/Output Panel**
- 12 **Dust Cover:** Gently lift out the dust cover from the front lens of the telescope. The dust cover should be replaced after each observing session and the power turned off to the telescope. Verify that any dew that might have collected during the observing session has evaporated prior to replacing the dust cover.
- 13 **ON/OFF LightSwitch:** Turns the LS system ON or OFF. The red LED power indicator light illuminates when power is on.
- 14 **Battery Compartment:** Insert eight ANSI 14A (IEC LR14) Alkaline "C-Cell" (user-supplied) batteries in compartment. Be sure batteries are aligned correctly as shown in the battery compartment.
- 15 **ECLIPS CCD Module:** The integrated camera is part of the system that allows the telescope to align itself, and provides you with a wide field imager when a video monitor is attached to your telescope.
- 16 **Red Dot Finder:** Provides an easy way to sight on objects and put them in the telescope's eyepiece.
- 17 **Red Dot Finder Alignment Screws:** Adjust these screws to align the Red Dot Finder with the telescope's main optics. See page 15 for more information.
- 18 **Handbox Storage Cradle:** Holds the AutoStar handbox in a convenient position on the telescope.
- 19 **Mini SD Card Slot:** Allows standard Mini-SD™ cards to be used to store images taken with the telescope. Can also be used to update the application firmware in the telescope.
- 20 **USB-A Connector for future expansion**
- 21 **USB-B Connector to PC:** Connects your telescope to a PC computer, so that the telescope can be remotely controlled from AutoStar Suite software, or other computer planetarium programs. This port can also be used to update the software in your telescope, manage custom catalogs, keep data on satellites, comets and asteroids current, and to download new tours to your telescope.
- 22 **Video Output:** This connector allows you to connect the telescope to a NTSC television monitor (not supplied). This monitor will display:
  - a. Multiple line menus.





b. Images from the ECLIPS camera.

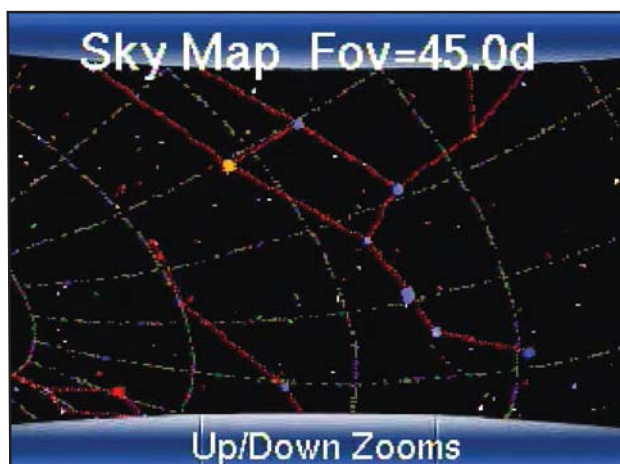

c. Sky maps of the region where your telescope is pointed



- d. Astronomer Inside videos and images of the moon, planets, and deep sky objects
- e. The Video Output can be toggled on/off with the 9/DISP key.

**23 Audio Output:** This connection will allow you to pass the telescope's stereo sound to external speakers, headphones or and external television monitor.

**24 Electronic Focuser Jack:** Plug in the optional Meade Zero Image Shift Micro-Focuser (P/N 07080) for precision focusing control.

**25 Handbox (HNDBX) Port:** Plug the AutoStar III coil cord (**Page 12, Fig. 4, 23**) into this port.

**26 12v Power Connector:** Provides connection so that the telescope system may be powered from either a 12v DC auto cigarette light plug or from a standard 115v AC home outlet using the optional Meade Universal Power Adaptor. It is important that only the Meade Universal Power Adaptor be used to power the telescope.

**27 AutoStar Suite Software:** Contains the LS Instruction Manual and a collection of useful software including a planetarium program, the AutoStar Updater for downloading and upgrading the firmware in the telescope, software to control the telescope from a computer and other programs all designed to enhance your use of the LS system.

## Using the Red-Dot Finder



Because your telescope has so much magnification, its field of view is very small. This can make it hard to know exactly where your telescope is pointing by simply looking at it. To help you point the telescope quickly and accurately, for terrestrial targets or when not using Auto Alignment and GO TO pointing, the LS has a 1X Red-Dot Viewfinder.

The Red-Dot Finder will aid you in pointing your telescope easily. It works much like a fighter pilot's heads-up display. To turn on the Red Dot Finder, carefully rotate the power switch until you feel it click on. Turning further clockwise will increase the dot brightness. Adjust the dot to the minimum brightness where it can be easily seen. This will extend its battery life and make it easier to see faint stars in the background. Look through the finder's glass window. You will see a red dot superimposed on your view. Using the direction keys on the handbox, move the telescope until the red dot is on the target you want to view in the eyepiece. As you get close to your target, select a moderately low speed, like speed 5, and move the scope to center your target as you look through the eyepiece. This a great way to get used to finding the movement keys without removing your eye from the eyepiece.

## Adjusting the Red-Dot Finder



The Red-Dot Finder has been aligned at the factory, but you may need to touch-up the alignment from time to time. To do this, look through the eyepiece of your scope and using the hand controller center a distant object. Now turn on the Red-Dot Viewfinder and adjust the brightness so you can see the red dot. Look through the sight as pictured above.

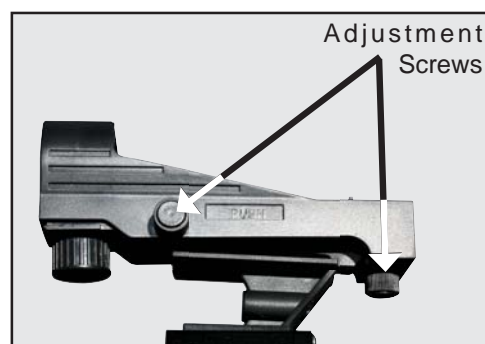

Now, without moving the telescope, adjust the indicated thumb screws until you have put the red dot on the object at which you were looking. It's that simple.

Now use the hand controller to put the laser dot on a new target. Check to see that the desired target is in the eyepiece.

## OPTIONAL ACCESSORIES

Meade makes a complete line of accessories to enable you to get the most fun and performance from your LS telescope. No matter what you want to accomplish, we have the equipment to help you get there.

### Choosing Eyepieces

A telescope's eyepiece magnifies the image formed by the telescope's main optics. Each eyepiece has a focal length, expressed in millimeters, or "mm." The smaller the focal length, the higher the magnification. For example, an eyepiece with a focal length of 9mm has a higher magnification than an eyepiece with a focal length of 26mm. Experienced users know that higher powers are, in general, not as useful as lower powers. Many of the objects in the night sky are relatively large and faint and look best at low magnifications.

The power or magnification of a telescope is determined by the focal length of the telescope and the focal length of the eyepiece being used. To calculate magnification, divide the telescope's focal length by the eyepiece's focal length. For example, a 26mm eyepiece is supplied with the LS. The focal length of the 6" LS is 1524mm (see SPECIFICATIONS, page 40).

Telescope Focal Length 1524mm

Eyepiece Focal Length 26mm

$$1524 \div 26 = 58.6x$$

The magnification is therefore 58.6x.

Low power eyepieces offer a wider field of view, bright, high-contrast images, and long eye relief. To find an object with a telescope, always start with a lower power eyepiece such as the Super Plössl 26mm or longer focal length. When the object is located and centered in the eyepiece, you may wish to switch to a higher power eyepiece to enlarge the image as much as practical for prevailing seeing conditions or, for many objects, the view is best with a high quality low-power wide-field eyepiece.

**NOTE:** Seeing conditions vary widely from night-to-night and site-to-site. Turbulence in the air, even on an apparently clear night, can distort images. If an image appears fuzzy and ill-defined, reduce to a lower power eyepiece.

Your telescope comes supplied with a Super Plössl 26mm eyepiece, which gives a wide 53 ARC Minute

(just a little less than 1 degree) field of view with 59x magnification. This is a very good all purpose eyepiece for your telescope, but you should consider buying additional eyepieces in longer and shorter focal lengths to fully realize the potential of the excellent 6" optical system in your LS telescope.

The Series 4000 Super Plössl Eyepieces are excellent



well corrected 4 element optics at popular prices. They come in a wide range of focal lengths to give you the right magnification for any type of celestial object you are viewing. You can also use one of the Series 4000 Barlows to double or triple the magnification of a Super Plössl eyepiece. These eyepieces have been the standard for over 30 years.

Series 4000 Super Plössl Eyepieces

Focal Length	Type	Apparent Field	Power	Actual Field
56.0mm	SP 2"	52°	27x	1° 55'
40.0mm	SP	44°	38x	1° 9'
32.0mm	SP	52°	48x	1° 6'
<b>26.0mm</b>	<b>SP</b>	<b>52°</b>	<b>59x</b>	<b>53'</b>
20.0mm	SP	52°	76x	41'
15.0mm	SP	52°	102x	31'
12.4mm	SP	52°	123x	25'
9.7mm	SP	52°	157x	20'
6.4mm	SP	52°	238x	13'



The **Series 5000 Premium Eyepieces** represent the highest level of eyepiece technology. Featuring advanced lens designs with 5, 6 and 7 elements, super fully multi-coated lenses and some of the widest fields of view available, they provide the user with the highest-contrast, pinpoint-sharp images and spectacular wide field views of the heavens. They are made to the same high quality standards as the primary optics in your LS 6" telescope and allow you to get all the performance that the Advanced Coma-Free and Schmidt-Cassegrain optical systems were designed to deliver. Use a Series 5000 Telextender for 2, 3 or 5 times the magnification of the eyepiece alone. There is even a 2x 2 inch Telextender for the large 2 inch eyepieces.

**NOTE:** 2 inch eyepieces require the optional Series 5000 2" Enhanced Diagonal with 99% Reflectivity (product number 07677) and the SC Thread to 2" Accessory Adapter (product number 07085).



**Series 5000 Ultra Wide Angle**



**Series 5000 Super Plössl**



**Series 5000 Super Wide Angle**



**Series 5000 2" Enhanced Diagonal**

**Series 5000 Eyepieces**

Focal Length	Type	Apparent Field	Power	Actual Field
40.0mm	5 EP 2"	60°	38x	1° 34'
32.0mm	5 EP 2"	60°	48x	1° 16'
26.0mm	5 EP	60°	59x	1° 1'
20.0mm	5 EP	60°	76x	47'
14.0mm	5 EP	60°	109x	33'
9.0mm	5 EP	60°	169x	21'
5.5mm	5 EP	60°	277x	13'

40.0mm	SWA 2"	68°	38x	1° 47'
32.0mm	SWA 2"	68°	45x	1° 31'
26.0mm	SWA 2"	68°	54x	1° 15'
20.0mm	SP	68°	64x	4'
15.0mm	SP	68°	76x	54'
12.4mm	SP	68°	95x	43'

30.0mm	UWA 2"	82°	51x	1° 37'
24.0mm	UWA 2"	82°	64x	1° 17'
18.0mm	UWA	82°	85x	58'
14.0mm	UWA	82°	109x	45'
8.8mm	UWA	82°	173x	28'
6.7mm	UWA	82°	227x	22'
4.7mm	UWA	82°	324x	15'

## Power Supplies

While the LS telescope will operate with 8 "C" cell batteries, you should consider several other power options that might work better for your situation and save you money.



**Universal AC Adapter (07584):** This adapter supplies a constant regulated 12 volt DC at up to 5 Amps from either a standard 115 volt AC or 220 volt AC household supply. It is the only tested and recommended AC power supply for the LS system.



**#607 DC Power Cord w/ Cigarette Lighter Adapter (07043):** This adapter allows you to plug into a standard automobile 12v DC power socket. It comes with a 25 foot cord so you can setup far from the car.

## Imagers and Accessories



Deep Sky Imagers (DSI)



The Meade 3.5 inch LCD monitor integrates fully with the LS telescope. Includes all connectors, dedicated battery pack (up to 20 hours of usage) and integral mounting bracket.



Camera Adapters



Off Axis Guiders



Focal Reducers

**Accessories at Meade.com.** Now you can order all these and more accessories or any Meade products right from the Meade Web Site [www.meade.com](http://www.meade.com) and it will be shipped right to your door.

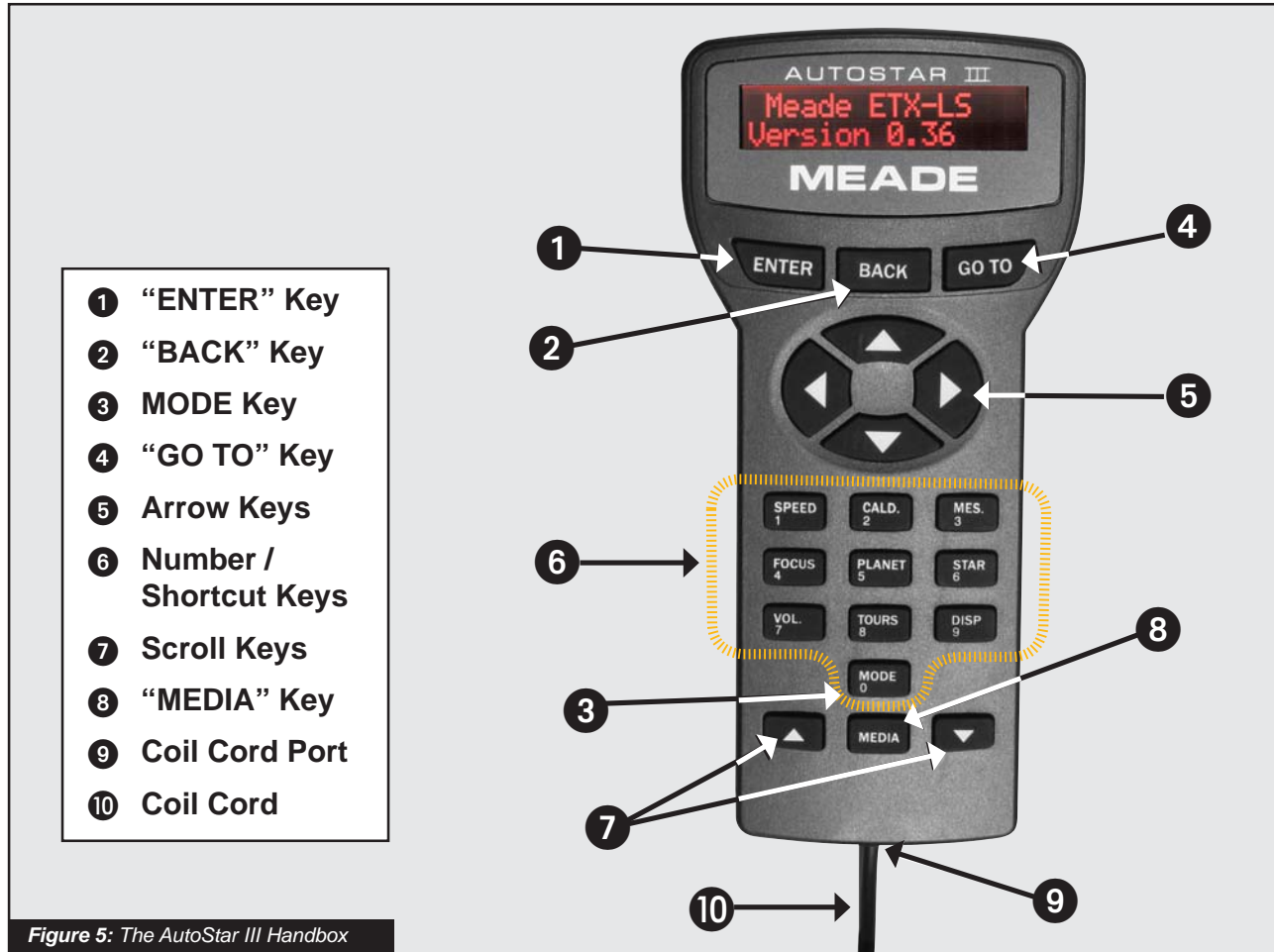

Figure 5: The AutoStar III Handbox

## Tour the Cosmos with Just the Push of a Button

The AutoStar III hand controller operates the LS telescope with just a few pushes of AutoStar's buttons. Some of the major features of AutoStar III are:

- Automatically move the telescope to any of over 90,000 objects stored in the database or manually enter the astronomical coordinates of any celestial object.
- Take a guided tour of the best celestial objects to view on any given night of the year.
- Download the latest satellite data and software revisions directly from the Meade website ([www.meade.com](http://www.meade.com)) and share software with other LS enthusiasts.

The AutoStar Computer handbox provides control of virtually every telescope function. AutoStar III has soft-touch keys designed to have a positive feel. The LCD (Liquid Crystal Display) is backlit with a red LED (Light Emitting Diode) for easy viewing in the dark. The backlit display, key arrangement, and sequential database make AutoStar extremely user friendly.

**2-Line LCD Display:** Provides an interface between LS and the user.

- **Top line:** Lists the primary category or menu item.
- **Bottom line:** Contains a menu option or additional information about an object or subject, depending on which function is being performed.

1 **“ENTER” Key:** Selects the option on the second line of the display. When you are looking at descriptive object text, **“ENTER”** will synchronize the telescope's coordinates with the object. This is most useful when synching on bright stars to achieve better pointing in the vicinity of the star. See NAVIGATING THE MENUS, page 9 and AUTOSTAR III MENU TREE, page 23.

2 **“BACK” Key:** Returns to the previous menu or data level in the AutoStar database until the top level, “Select Item,” is reached.

*NOTE: Pressing “BACK” while in the “Select Item” level moves LS to the topmost screen: “Select Item: Object.”*

3 **“MODE” KEY:** Cycles the telescope through its different modes.

*NOTE: During any telescope operation, pressing and holding the “MODE” key will stop the current operation*

From a mode other than the Menu Mode, pressing the **“BACK”** key will return the telescope to Menu Mode.

**Scope Info:** When in Menu Mode, pressing **“MODE”** changes the telescope into Scope Information Mode. Information about the telescope's status displays on the handbox and any attached video monitor. When the status displays, press one of the Scroll keys (**Pg. 19, Fig. 5, 7**) to display the following information:

- Right Ascension and Declination (astronomical) coordinates.

- Altitude (vertical) and Azimuth (horizontal) coordinates .
- Local Time and Local Sidereal Time (LST)
- Timer and Alarm Status
- Date
- Site coordinates
- Battery status
- Telescope Serial Number
- Free Memory remaining in the telescope

**Sky Map:** Press **“MODE”** again and the scope changes to SkyMap Mode. In this mode, an attached video monitor will display a tracking sky map, showing the stars and constellations in the area to which the telescope is pointed. Pressing the scroll-up and scroll-down keys will zoom the map in and out.

**Menu:** Press **“MODE”** again to return to the Menu Mode.

4 **“GO TO” Key:** Slews (moves) the telescope to the coordinates of the last selected object. While the telescope is slewing, the operation may be aborted at any time by pressing any key except **“GO TO”**. Pressing **“GO TO”** again resumes the slew to the object.

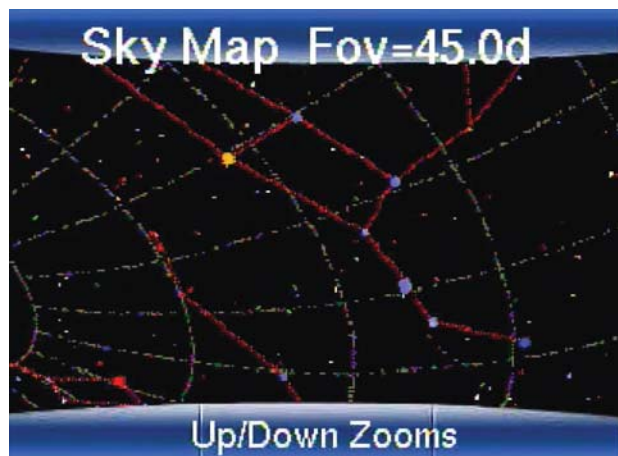



**5 Arrow Keys:** Slew the telescope in a specific direction (up, down, left, and right), at any one of nine different speeds. Speed selection is explained in “SLEW SPEEDS”, below. The following functions are also available with the Arrow keys:

- **Moves the telescope** – Use the Up and Down Arrow keys to move the telescope vertically up and down. The Left Arrow key rotates the telescope horizontally counterclockwise, while the Right Arrow key rotates it clockwise.
- **Data entry** – When the scope is prompting for user entered data, use the Up and Down Arrow keys to scroll through the letters of the alphabet and numerical digits. The Down Arrow key starts with the letter “A” and the Up Arrow key starts with the digit “9.” The Left and Right Arrow keys are used to move the blinking cursor left and right across the LCD display.
- **Catalog Paging** – When the scope is presenting long catalogs of information, cities, celestial objects, stars, etc..., you can move through the list a page (8 items) at a time using the up and down arrow keys.

**6 Number Keys:** Each number key on the handbox serves a dual function. When you prompted to enter numerical information, the keys allow you to directly enter digits into the handbox. At all other times, the numeric keys act as shortcuts to frequently accessed places in the menu tree. The keys have the follow effect:

**“1/Speed”** – instantly brings up the scope slew speed menu so you can change the slew rate of the telescope

**Slew Speeds**

LS has nine slew speeds that are directly proportional to the sidereal rate (the rate at which stars appear to drift across the sky) and have been calculated to accomplish specific functions. Pressing a Number key changes the slew speed, which is shown for about two seconds on AutoStar’s display.

To change the speed, press the 1/Speed. Nine available speeds are:

- Number Key “1” = 1x
- Number Key “2” = 2x
- Number Key “3” = 8x
- Number Key “4” = 16x
- Number Key “5” = 0.25°/sec
- Number Key “6” = 0.50°/sec
- Number Key “7” = 1.0°/sec
- Number Key “8” = 2.0°/sec
- Number Key “9” = 4.0°/sec

**Speeds “1”, “3”, or “3”** Best used for fine centering of an object in the field of view of a higher power eyepiece, such as a 12mm or a 9mm eyepiece.

**Speeds “4”, “5”, or “6”:** Enables centering an object in the field of a low-to-moderate power eyepiece, such as the standard Super Plössl 26mm.

**Speeds “7” or “8”:** Best used for rough centering of an object in the Red-Dot Viewfinder.

**Speed “9”:** Moves the telescope quickly from one point in the sky to another.

**“2/Caldwell”** – instantly brings up the Caldwell catalog entry menu, so you can access any Caldwell object by its catalog number.

**“3/Messier”** – instantly brings up the Messier catalog entry menus, so you can access any Messier object by its catalog number.

**“4/Focus”** – If you have a optional electric focuser attached to your telescope, this key will change the function of the Arrow keys, to move the focuser in and out, rather than to move the telescope.

**“5/Planet”** – instantly brings up the solar system object selection menu. So you can quickly locate the moon, planets, comets and asteroids.

**“6/Stars”** – instantly brings up the star catalog selection menu, so you can quickly locate bright stars by name, or select stars by their catalog index numbers.

**“7/Volume”** – brings up the volume control for the built in speaker in your telescope.

**“8/Tours”** – instantly brings up the guided tours

“9/Display” – Toggles video output between on/off.

“0/Mode” – This key lets you cycle through the telescope’s modes, (See the entry above).

- 7 **Scroll Keys:** Accesses options within a selected menu. The menu is displayed on the first line of the screen. Options within the menu are displayed, one at a time, on the second line. Press the Scroll keys to move through the options. Press and hold a Scroll key to move quickly through the options. When entering data, the Scroll Down key and the Down Arrow key move forward through the alphabet & digits (A to Z, 0 to 9). The Scroll Up key and the Up Arrow key move backward (Z to A, 9 to 0). Common symbols are also available in the list.
- 8 **“MEDIA” Key:** The media key lets you toggle help and audio/video descriptions on and off. At any time you are navigating the menus, pressing the Media Key will start an explanation of the menu’s function. If you have selected an object, pressing the media key, will tell you more about the object. If a media clip is playing, pressing “MEDIA” stops the media clip and moves you back to the menu or object display.
- 9 **Coil Cord Port:** Plug one end of the AutoStar coil cord into this port (Pg. 19, Fig. 5, 9) located at the bottom of the AutoStar handbox.
- 10 **Coil Cord:** Plug one end of the AutoStar coil cord into the HNDBX port (Pg. 12, Fig. 4, 23) of the input/output panel of the telescope and the other end into the coil cord port (Fig. 5, 9).



Orion Nebula (M42)

## LS TIPS

### Observing Considerations

- Try to pick an observing site away from street and house lights and car headlights. While this is not always possible, the darker the site, the better.
- Try not to use a standard flashlight. Experienced observers use red LED flashlights, the red utility light on the AutoStar III handbox, or tape red cellophane over their flashlights to use for setup and map reading so they don’t have to continually readjust their eyes to the darkness. Be careful not to shine bright lights if there are other observers in the area. Do not shine a flashlight into the telescope while someone is observing!
- Dress warmly. It gets chilly when you’re sitting for prolonged periods.
- Practice setting up your equipment during the day or in a lighted area to become familiar with it before going to a dark site.
- Use your 26mm eyepiece to view terrestrial objects and wider areas of space, such as open star clusters. Use optional higher power eyepieces, such as a 9mm eyepiece, when you wish to view something up close, such as craters on the Moon or the rings of Saturn.

# AUTOSTAR III MENU TREE

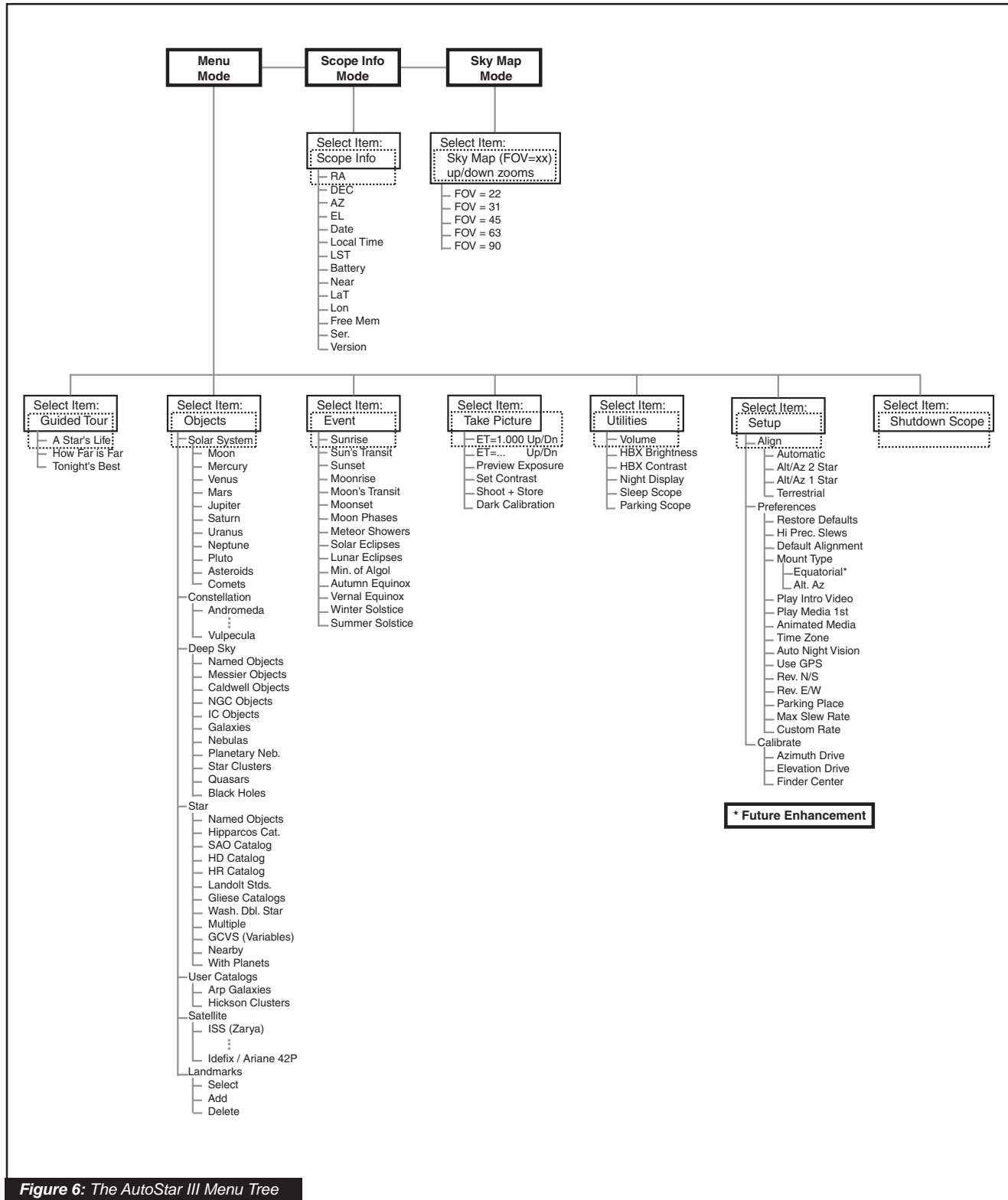

Figure 6: The AutoStar III Menu Tree

## Guided Tour Menu

When Guided Tours is selected, AutoStar III shows you a list of theme tours that will help you explore the night sky. These tours are pre programmed presentations of objects that are visible for the user's particular location, time and date.

The most popular tour is "Tonight's Best" that guides the user to the best objects that are currently up in the night sky. This tour is the easiest way to get started exploring the cosmos with your new LS telescope.

Each tour will select the objects, present multi-media clips about the object and, if you press "GoTo", put that object in the eyepiece of the telescope for you to view.

To exit a tour, press "Mode".

The telescope comes pre-loaded with:

- **"Tonight's Best"**, a selection of the most interesting objects visible on any night.
- **"A Star's Life"**, explains how stars are formed, created, changes through their lives and finally die using examples that are visible tonight.
- **"How Far is Far"**, an explanation of the phenomenal distances you can see with your LS.

AutoStar Suite also allows you to create your own guided tours of the skies, including your own objects, titles, images and sound files (for complete instructions on how to use the authoring tools please refer to the reference manual included on the AutoStar Suite DVD).

## Object Menu

Almost all observing with LS is performed using the Object menu category. (**NOTE: Exceptions include Guided Tour and Landmarks**).

Many LS menu categories contain databases. An LS database is a list of objects, such as stars, planets, comets, nebulae and so forth. When one of these objects is selected from a database by pressing "ENTER" and then "GO TO", LS moves your telescope (when properly aligned) and points it at the selected object.

The Object Menu options include:

**Solar System** is a database of the eight planets (Earth is not included) in ascending orbits from the Sun, followed by the Moon, asteroids, and comets.

**Constellation** is a database of all 88 Northern and Southern Hemisphere constellations. When this menu option is chosen and a constellation name appears on the first line of the screen, the multimedia description of the constellation is played. When the media presentation completes, or you press the "MEDIA" key to halt the presentation, a menu gives you three choices:

- **Show Summary** – presents the key data about the constellation.
- **Walk the Stars** – presents a catalog of the brightest stars in the constellation so that you can walk the constellation figure.
- **Show Objects** – presents a list of the best deep sky objects in this constellation for you to explore.

**Deep Sky** is a database of objects outside our Solar System such as nebulae, star clusters, galaxies, and quasars grouped in various catalogs like Messier, Caldwell and NGC.

**Star** is a database of stars listed in different categories such as named, double, variable, or nearby.

**Important Note:** When you are looking at descriptive object text, pressing "ENTER" will synchronize the telescope's coordinates with the object. This is most useful when synching on bright stars to achieve better pointing in the vicinity of the star.

**User Catalogs** allows the user to define and store in memory deep-sky objects of specific interest that are not currently in the LS database. See Appendix B, page 37 for more information (for complete instructions on how to use the authoring tools please refer to the reference manual included on the AutoStar Suite DVD).

**Satellite** is a database of Earth-orbiting objects such as the International Space Station (ISS), the Hubble Space Telescope (HST), Global Positioning System (GPS) satellites, and geosynchronous orbit satellites. In order to find and track satellites, you must download recent orbital data into the telescope.

**Landmarks** stores the location of terrestrial points of interest that you create in the permanent LS database.

**IMPORTANT NOTE:** To use the Landmark function, the telescope must be located and aligned exactly as



when the landmark was added to the database.

- **Select** – To select a Landmark already in the database (see ADD below), choose the “Select” option and scroll through the list. Press “ENTER” to select a Landmark, then press “GOTO” and the telescope slews to the object.
- **Add** – To add a Landmark, choose the “Add” option. Enter a name for the Landmark. Locate and center the Landmark in the eyepiece, then press “ENTER”.

## Event Menu

The Event menu provides access to dates and times of astronomical events. The Event database includes:

**Sunrise and Sunset** calculates the time that the Sun rises or sets on the current date.

**Moonrise and Moonset** calculates the time that the Moon rises or sets on the current date.

**Moon Phases** displays the date and time of the next New, 1st Quarter, Full and 3rd Quarter Moon.

**Meteor Showers** provides information on upcoming meteor showers, such as the Perseids, the Leonids, etc. Also lists the dates of the showers and when they reach maximum.

**NOTE:** *Meteors are fast moving objects that cover large areas of the sky and are usually best observed with the naked eye.*

**Solar Eclipse** lists upcoming Solar Eclipses, including the date and type (total, annular, or partial) of eclipse, and the location and time of the first and last contacts of the Moon’s shadow. Use the Scroll Up and Down keys to display the available data. **Remember, never use a telescope to look at the Sun!**

**Lunar Eclipse** lists upcoming Lunar Eclipses, including the date and type (total, partial, penumbral) of eclipse. Use the Scroll Up and Down keys to display the available data.

**Min. (Minimum) of Algol** is the minimum brightness of the dramatic eclipsing binary star system, Algol. It is relatively close at a distance of 100 light years. Every 2.8 days during a 10 hour period, Algol undergoes a major change in apparent magnitude as one of the two stars passes behind the other. The combined magnitude of the two stars thus dips from +2.1 to a minimum of

+3.4 halfway through the eclipse as the second star is hidden. LS calculates minimum magnitude time at mid-eclipse.

**Autumn and Vernal Equinox** calculates the time and date of the fall or spring equinox of the current year.

**Winter and Summer Solstice** calculates the time and date of the winter or summer solstice of the current year.

## Take Picture Menu

You can take wide-field images of the night sky with the ECLIPS CCD Module that is part of the LightSwitch alignment system. It’s great for constellation shots and you can see some large bright deep sky objects as well.

Note that while you take and store images on to a user supplied Mini SD Card for download to your PC, to fully use many of the options below and to preview your



**The Pleiades Star Cluster (M45)**

image you need to connect the LS to a user supplied external video monitor.

Start by selecting “Take Picture” from the top menu:

“Take Picture” > “ENTER”

Then you will see the following options:

- **Preview Exposure:** Displays “Finder Image; Exposing...”. UP/DOWN adjusts Exposure Time (ET). A longer exposure records fainter stars. A shorter exposure records fainter stars. A shorter exposure is better for very bright subjects.
- **Set Contrast:** UP/DOWN selects scrolls through the thirteen pre-set Contrast curves available, “Cont. Day”, “Cont. Moon”, “Cont. Planet”, “Cont.

Stars”, and “Cont. Deep1” thru “Cont. Deep9”.

The setting after “Cont. Deep9” is Cust.Cont. (Custom Contrast). This setting allows you adjust the Contrast AND Brightness to create your own setting. Contrast is controlled using the LEFT/ RIGHT Arrow Keys. Brightness is controlled using the UP/DOWN Arrow Keys. NOTE: to fully utilize these the Custom Contrast setting you will need the use of an external monitor. Otherwise chose one of the thirteen pre-set Contrast curves.

- **Shoot & Store:** Allows you to take the image and save it to the SD once you have adjusted the settings and are happy with the preview. You must have an Mini SD Card formatted with the FAT32 file system inserted in the telescope to use this function. Press the “**BACK**” key to save the image.
- **Dark Calibration:** Allows you to take a dark frame of the same exposure as your image but with the camera lens covered to combine and subtract out noise from your image. You must cover the camera lens with the lens cap before you take the dark calibration frame.

**Deep Sky Imager (DSI) Series:** these high-performance, easy-to-use and affordable color and



black and white CCD camera suppresses electronic noise and by not compressing data from the sensor to increase picture quality. The Deep Sky Imager uses a full 16-bit analog-to-digital converter to enhance picture depth, contrast and dynamic range.

The DSI series are USB compatible to easily interface with most Windows-based laptop computers. It includes AutoStar Suite which automatically sorts, aligns and combines the best images, resulting in a

highly detailed color image.

The following Deep Sky Imagers models and accessories are available:

- Deep Sky Imager III (DSI III)
- Deep Sky Imager Pro III (DSI PRO III)
- Deep Sky Imager II (DSI II)
- Deep Sky Imager Pro II (DSI PRO II)
- Deep Sky Imager Pro II (DSI PRO II), w/RGB Color Filter Set

### Utilities Menu

The Utilities menu provides access to several extra features within LS:

**Volume:** Adjusts audio volume of the telescope using the Scroll keys. When complete, press “**ENTER**”.

**HBX Brightness:** Adjusts the brightness of the display using the Scroll keys. When complete, press “**ENTER**”.

**HBX Contrast:** Adjusts the contrast of the display using the Scroll keys. When complete, press “**ENTER**”.

**Night Vision:** When you have an external video monitor attached to your telescope, you will find the bright colorful displays may affect your night vision and make it difficult to see dim objects in the eyepiece of your telescope. The human eye’s sensitivity actually increases for about the first half hour you are in the dark. You have noticed this when you walk out of a dark theater into the daytime sun, how over bright the day seems. This dark adaptation of your eye can be reduced by white light. Red light does not have this effect on dark adapted vision. The night vision option on your telescope will change the display from color, to shades of red. There are three settings:

**Auto** – The video will automatically switch to red at night.

**On** – Selects full-time red video.

**Off** – Selects full-time color video.



**Sleep Scope** is a power and time saving option that shuts down the LS telescope without forgetting its alignment. With “Sleep Scope” selected, press “ENTER” to activate the Sleep function. LS goes dark, but the internal clock keeps running. Press any key, except “ENTER”, to re-activate LS.

**Park Scope** is designed for a telescope that has not moved between observing sessions. Align the telescope one time, then use this function to park the telescope. Next time it is powered up, no alignment is required. Pressing “ENTER” causes the telescope to move to its pre-determined Park position. Once parked, the screen prompts to turn off power.

**IMPORTANT NOTE:** When the “Park Scope” option is chosen and the display prompts you to turn off the telescope’s power, LS is unable to be returned to operation without turning the power off and then back on.

## Setup Menu

The Setup menu’s primary function is to align the telescope. However, there are numerous other features available within the Setup menu, including:

**Align** prepares your telescope to automatically locate and track objects. There are four different alignment methods available. Unless you specifically disable LightSwitch as the default alignment, the scope will use this method immediately upon powering up. If you desire to use an alternate method below, be sure to disable automatic alignment in the preferences.

- **Automatic Align** will use the LightSwitch® alignment method to align your telescope.
- **Alt. Az. 2 Star** will begin the interactive two star alignment process. Complete details are described in the Advanced LS features section of this manual.
- **Alt. Az. 1 Star** will begin the interactive one star alignment process. Complete details are described in the Advanced LS features section of this manual.
- **Terrestrial** will set up the telescope to use on land objects.

**Preferences** allows you to configure the telescope’s behaviors to suit your own viewing tastes. Configurable options include:

- **Restore Defaults** sets all the settings back to the factory original values.
- **Hi Precision Slews** allows you to turn high precision slews on and off. When this feature is enabled and you command the telescope to GoTo and object, it will first slew to a nearby star and ask you to center the star and then press “ENTER” to proceed. This feature insures the target will be in the precise center of the eyepiece. With faint objects at the limit of your scope, or when making astro-images, enabling Hi Precision assures you are right on target.
- **Default Alignment** allows you to enable or disable LightSwitch alignment when the scope powers up. When you disable default alignment, the telescope will require you to select and perform one of the alignment procedures under the Setup menu before your telescope will automatically locate and track objects.
- **Play Intro Video** allows you to disable the introductory media message that plays when the telescope is first powered up.
- **Play Media 1<sup>st</sup>** allows you to select when multimedia object descriptions are played. As shipped from the factory, the telescope is configured to play the descriptive media before showing you the object data. Disabling the Media 1st option, will cause the object’s data to be displayed immediately upon object selection. If you wish to hear the descriptions, you must explicitly press the “MEDIA” key.
- **Animated Media** allows you to bypass the animated portion of the media. As shipped from the factory, most objects have two media clips. The first is an animated overview narrated by a male voice. This is followed by a second, more detailed description given by a female narrator. Disabling “Animated Media” will skip playing the audio/video media clip and go to the audio only presentation.
- **Time Zone** allows you to select an international time zone, or to manually configure a time zone to any fraction of an hour you need.
- **Use GPS** allows you to disable use of the GPS to determine the time and your telescope’s location. If your scope is mounted in an

observatory, or on a permanent mount, disabling the GPS can speed your startup. When the GPS is disabled, you are presented a menu that offers you the choice of using the previous locations, and the internal clock time, entering the date, time and location manually, taking a GPS fix, or starting in a Demo/Terrestrial mode.

- **Rev. N/S** allows you to reverse the function of the up and down arrow keys. This can be handy when using diagonals.
- **Rev. E/W** allows you to reverse the function of the left and right arrow keys. This can be handy when using diagonals.
- **Parking Place** allows you to set a custom park position. This is convenient for permanently mounted scopes that will be restarted and parked after every use.
- **Custom Rate** allows you to make minor adjustments to the telescopes tracking rate.

*Tip: If you are having difficulties with the telescope, the first step to getting back on track is to use the Preferences – Restore Factory Defaults command rate.*

**Calibrate** allows you to precisely tune several aspects of your telescope for peak performance. Calibration options include:

- **Azimuth Drive** allows you train your azimuth drive for peak pointing accuracy.
- **Elevation Drive** allows you train your elevation drive for peak pointing accuracy.
- **Finder Center** recomputes the center of the ECLIPS camera. When you change diagonals or other equipment the alignment of the equipment with the ECLIPS camera can change. If you are getting good alignments, but objects are consistently off center by the same amount, you should use the option to improve centering.



# ADVANCED LS FEATURES

## Two Star Alt Az Alignment

1. Select Alt. Az. 2 Star alignment from the Align menu to begin two star alignment.
2. “Automatic Alignment” displays. The system now performs the following routines (press any ETX-LS key to abort Automatic Alignment).

**Caution:** As the telescope performs the following operations, it will swing and rotate. Keep a safe distance from the telescope. The telescope now finds the level and tilt position of the telescope, and also detects where true North is. It may not actually level or tilt the telescope or point to North—it is just detecting these positions. This may take a minute or two.

- a. Attempts a “GPS Fix”. The GPS receiver attempts to acquire and sync up with signals from GPS satellite system. “Getting GPS Fix” displays Note: Press Mode key to abort the GPS fix. You will then be prompted to enter the time, date and location.
- b. Detects “level” of the base of the telescope; finds tilt and tip. To detect level, LS must calculate “level” at three compass points. LS also determines the positioning (i.e., tilt and tip) of the optical tube.
- c. Finds North. Locates magnetic North, then calculates true North.

**NOTE:** After performing these operations, LS now knows:

- The telescope’s limiting positions
  - Where level is for the telescope
  - The location of true North
  - The observing site’s location
  - The date and time
- d. Once the level, tilt and North are detected, the telescope will “GO TO” 2 alignment stars. The telescope will go to these stars in order to orient itself to the sky. Once it has done this, it will be able to point to any one of nearly 100,00 objects in its database.

- e. “Automatic Alignment: Selecting Star” and “Slewing” display. When it is close to the alignment star “Center Brightest Star: Press “ENTER”” displays. When the telescope slews to the first star, it may not appear in the field of view in the eyepiece. Use the Red Dot Finder (Pg. 12, Fig. 2, 16) to locate the star. The alignment star will be easy to recognize—it will be the brightest star in the area of the sky where the telescope is pointing. Use the Arrow keys to center the alignment star in the eyepiece. When the alignment star is centered, press “ENTER”. Repeat the procedure for the second alignment.
- f. The telescope now slews to the second alignment star. LS displays “Center Brightest Star”.
- g. “Press “ENTER”” displays. Use the Arrow keys to center the alignment star in the eyepiece. When the second alignment star is centered, press “ENTER”.
- h. “Alignment successful” displays. If “Alignment Unsuccessful” displays, perform the procedure again.

**NOTE:** If you have an obstruction, such as a tree or a building blocking your view of the alignment star, or if you have any doubts at all about the star that has been chosen, no problem. Just press the SCROLL DOWN key and LS will find another star to align upon.

**NOTE:** The selected alignment stars may vary by date and time. All that is required is for the observer to center the selected stars in the eyepiece when prompted.

**IMPORTANT NOTE:** The “Telescope: Mount” option of the Setup menu is set to “Alt/Az” as the default alignment by the factory. The example presented in this section assumes that you are performing an alignment procedure for the first time with your telescope and therefore, the “Telescope: Mount” option does not need to be selected.

## Alt/Az 1 Star Alignment

One-Star Alignment requires some knowledge of the night sky. LS provides a library of bright stars. One-Star Alignment is identical to Two-Star Alt/Az: Alignment (see TWO-STAR ALT/AZ ALIGNMENT above), except only one star from the database is chosen by the observer for alignment.

## Finding Objects Not in the Database

Although LS contains an extensive database of celestial objects (stars, nebulae, planets, etc.) that you can observe, you may eventually want to view objects that are not part of the database. LS provides a feature that allows you to enter an object's R.A. and Dec. and allows automatic slewing of the telescope to the user-entered coordinates.

In order to use this option, you first need to look up the R.A. and Dec. coordinates of the object or objects you wish to observe. Check out the Internet, local library, or bookstore for astronomy books, CD ROMs, or magazines (such as Sky & Telescope or Astronomy), to find coordinates of celestial objects.

### To enter coordinates of an object into the Telescope:

1. Make sure LS has been initialized and the telescope has been aligned.
2. From any menu press the "**MODE**" key to change to Scope Info mode.
3. Scroll the display until the telescopes Current RA is displayed.
4. Press the "**GOTO**" key. The scope will now prompt you to enter the object's coordinates.
5. "Right Asc.: 00.00.0" displays. Use the Number keys to enter the digits for the Right Ascension coordinate of your object. When you are finished, press "**ENTER**".
6. "Declination: +00°.00'" displays. Use the Number keys to enter the digits for the Declination coordinate of your object. If necessary, use the Scroll Keys to change "+" to "-". When you are finished, press "**ENTER**".
7. The telescope will now slew to your object.

## Landmarks

This menu option allows you to define and store terrestrial objects in the Landmark database. First, a landmark needs to be stored in memory using the "Landmark: Add" option. To view a landmark, use the "Landmark: Select" option.

### To add a landmark to the database

In this procedure, you will store the location of terrestrial landmarks in LS's memory.

1. Set the telescope in the home position, if necessary. Note for future reference where the telescope is located and if you have aligned the telescope, which alignment method is used.

**IMPORTANT NOTE:** *To use the Landmark function, the telescope must be located and aligned exactly as when the landmark) was added to the database.*

2. Display the "Setup: Targets" menu option. Chose "Terrestrial" and press "**ENTER**". Choosing this option turns off tracking for astronomical objects. Be sure to change this option back to "Astronomical" when you wish to view celestial objects again.
3. Press "**BACK**" once. "Select Item: Setup" displays.
4. Press the Scroll Down key once and "Select Item: Object" displays. Press "**ENTER**". "Object: Solar System" displays.
5. Press the Scroll Up key twice and "Object: Landmarks" displays. Press "**ENTER**". "Landmark: Select" displays.
6. Press the Scroll Down key once. "Landmark: Add" displays. Press "**ENTER**".
7. "Landmark Name" displays. Using Arrow keys, enter a name for the landmark you wish to add to the database. When finished, press "**ENTER**".

8. "Center Landmark. Press "ENTER"" displays. Using only the Arrow keys (do not manually move the telescope), move the telescope to the desired landmark and center the object in the eyepiece. Press "ENTER". The object is now stored in memory.
9. "Landmark: Add" displays. If you wish to add more landmarks, repeat steps 5 through 7.

#### To view a landmark in the database

1. Make sure the telescope is located and aligned exactly as when the desired landmark was entered into memory.
  2. Display the "Landmark: Select" menu option. Press "ENTER".
  3. Use the Scroll keys to scroll through the list of objects you have previously entered. When the desired object displays, press "ENTER" to select the object. Use the Scroll keys to scroll through location information about the object, if desired. Press "GO TO" to slew the telescope to the landmark.
  4. Press "BACK" to exit.
7. When the alarm goes off, return to the Satellite menu and press a Scroll key until the desired satellite is on the top line of the display.
  8. Press "GO TO", LS slews the telescope to where the satellite should appear. The motor drive stops and a countdown is displayed.

**NOTE:** If the scheduled appearance position of the satellite is obstructed (i.e., by a building, tree, or hill), press "ENTER" and LS starts to move the telescope along the expected satellite track. When the track clears the obstruction, press "ENTER" again to pause the telescope, then continue with this procedure.

9. With about 20 seconds left on the countdown timer, start watching through the telescope Red Dot Finder (Pg. 12, Fig. 2, 16) for the satellite to enter the field of view.
10. When the satellite enters the viewfinder field of view, press "ENTER". The telescope starts to track with the satellite.
11. Use the LS Arrow keys to center the object in the viewfinder, then look through the eyepiece to view the object.

### Observing Satellites

In this procedure, you will prepare your telescope to observe a satellite pass.

1. Navigate to the "Object: Satellite" menu option and press "ENTER".
2. Use the Scroll keys to scroll through the list of satellites.
3. Select a satellite from list and press "ENTER".
4. "Calculating..." and then "Tracking..." displays. If the satellite is going to make a pass, "Located" displays.
5. Use the Scroll keys to display data about the pass: aos — acquisition of signal and los — loss of signal. If you subtract the aos from the los, you can calculate how long the satellite will be visible. Location information also displays.
6. "Alarm" displays after the location information. Press "ENTER" and LS automatically sets the alarm to sound a minute before the satellite's scheduled appearance. You may return to regular observations until the alarm goes off.

Satellite orbits change and new satellites (including the Space Shuttle) are launched. You can use the AutoStar Updater program approximately once a month to get updated information and instructions on how to download this data to LS. If orbital parameters are more than one month old, the satellite pass may not happen at the time predicted by LS. Downloading requires you use a USB cable to connect the telescope to a PC to update the satellite elements.

**NOTE:** Satellite observing is an exciting challenge. Most satellites are in low orbit, traveling at approximately 17,500 mph. When visible, they move quickly across the sky and are only in the field of view for a few minutes, requiring LS to slew the telescope rapidly. Best viewing is near sunrise or sunset when the sky is dark. Viewing in the middle of the night can be problematic because the satellite may pass overhead, in the Earth's shadow.

## Terrestrial Observing

The LS is an excellent high-resolution, terrestrial (land) telescopes. Viewing terrestrial objects requires looking along the Earth's surface through heat waves. These heat waves often cause degradation of image quality. Lower power eyepieces, like the Super Plössl 26mm eyepiece, magnify these heat waves less than higher power eyepieces. Therefore, lower power eyepieces provide a steadier, higher quality image. If the image is fuzzy or ill-defined, reduce to a lower power eyepiece, where the heat waves do not have such an effect on image quality. Observing in early morning hours, before the ground has built up internal heat, produces better viewing conditions than during late afternoon hours.

If you wish to observe a distant land object, such as a mountain top or a bird, you want to use your telescope in its Terrestrial Observing mode. To start up the telescope in Terrestrial mode:

1. Turn on the telescope.
2. When you hear the introductory audio, press the **"MODE"** key. The telescope will move to the home position, and when it has stopped "Select Item" will show on the Handbox screen. Use the SCROLL keys to move through the menu to "Align". Press the **"ENTER"** key again to set-up the "Align" menu. Use the SCROLL keys to move to "Terrestrial" and hit **"ENTER"**.
3. Move your telescope using the direction arrows on the handbox while looking through the Red-Dot Finder to put your target in the eyepiece.
4. Focus on the target with the focus knob (**pg. 12, Fig. 2, 9**).

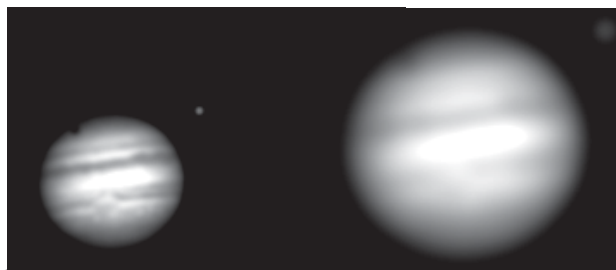

**Figs. 7a & 7b:** Jupiter; examples of the right amount of magnification and too much magnification.



Capitol Reef, Utah

### LS TIPS

#### Too Much Power?

Can you ever have too much power? If the type of power you're referring to is eyepiece magnification, yes, you can! The most common mistake of the beginning observer is to "overpower" a telescope by using high magnifications which the telescope's aperture and atmospheric conditions cannot reasonably support. Keep in mind that a smaller, but bright and well-resolved image is far superior to one that is larger, but dim and poorly resolved (see Figs. 7a and 7b to the left). Powers above 400X should be employed only under the steadiest atmospheric conditions.

Most observers should have three or four additional eyepieces to achieve the full range of reasonable magnifications possible with the LS telescopes. See **OPTIONAL ACCESSORIES**, page 16.



## MAINTENANCE

The LS is a precision optical instrument designed to yield a lifetime of rewarding viewing.

Given the care and respect due any precision instrument, the LS will rarely, if ever, require factory servicing. Maintenance guidelines include:

1. Avoid cleaning the telescope's optics: a little dust on the front surface of the telescope's correcting lens causes virtually no degradation of image quality and should not be considered reason to clean the lens.
2. When absolutely necessary, dust on the front lens should be removed with gentle strokes of a camel hair brush or blown off with an ear syringe (available at any pharmacy). **DO NOT** use a commercial photographic lens cleaner.
3. Organic materials (e.g., fingerprints) on the front lens may be removed with a solution of 3 parts distilled water to 1 part isopropyl alcohol. You may also add 1 drop of biodegradable dishwashing soap per pint of solution. Use soft, white facial tissues and make short, gentle strokes. Change tissues often.
4. **CAUTION:** *Do not use scented or lotioned tissues that can damage the optics.*
5. **Do not, for any reason, remove the correcting plate from its machined housing for cleaning or other purposes. You will almost certainly not be able to replace the corrector in its proper rotational orientation and serious degradation of optical performance will result. Meade Instruments assumes no liability for damage incurred to the telescope in this way.**
6. If the LS is used outdoors on a humid night, water condensation on the telescope surfaces will probably result. While such condensation does not normally cause any damage to the telescope, it is recommended that the entire telescope be wiped down with a dry cloth before the telescope is packed away. Do not, however, wipe any of the optical surfaces. Rather, simply allow the telescope to sit for some time in the warm indoor air, so that the wet optical surfaces can dry unattended.

7. If the LS is not to be used for an extended period, perhaps for one month or more, it is advisable to remove the batteries from the telescope. Batteries left in the telescope for prolonged periods may leak, causing damage to the telescope's electronic circuitry.
8. Do not leave the LS inside a sealed car on a warm summer day; excessive ambient temperatures can damage the telescope's internal lubrication and electronic circuitry.

### Collimation

The optical collimation (alignment) of any astronomical telescope used for serious purposes is important, but in the case of the Schmidt-Cassegrain design of the LS, such collimation is absolutely essential for good performance. Take special care to read and understand this section well so that your LS will give you the best optical performance.

As part of final optical testing, every Meade Schmidt-Cassegrain is precisely collimated at the Meade factory before shipment. However, vibrations in shipping can cause the optical system to become misaligned. Re-aligning the optics is, however, a straightforward process.

To check the collimation of your LS, center a bright star that is overhead, or use a "hot spot" of reflected Sunlight from a chrome car bumper, with the supplied 26mm eyepiece. Allow the telescope to adjust to the temperature of your observation site before proceeding; temperature differences between the optics and the outside air can cause distortion in the images.

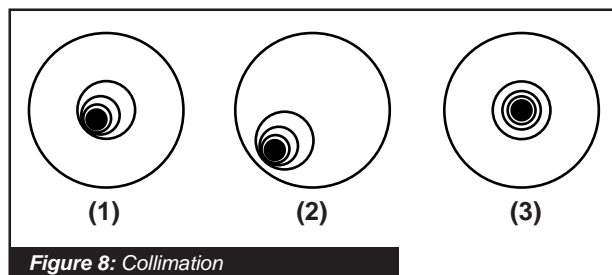

Figure 8: Collimation

With the star or hot spot centered, de-focus the image.

You will notice that the out of focus star image looks like a ring of light surrounding a dark central spot; the

dark central spot is in fact the shadow of the secondary mirror. Turn the focus knob until the ring of light fills about 10% of the eyepiece field-diameter. If the dark central spot is offset in (i.e., not concentric with) the ring of light, your telescope's optical system is misaligned and requires collimation.

Follow these steps for collimation of the optical system:

1. The only adjustments possible, or necessary, on the LS are from the three inner most screws

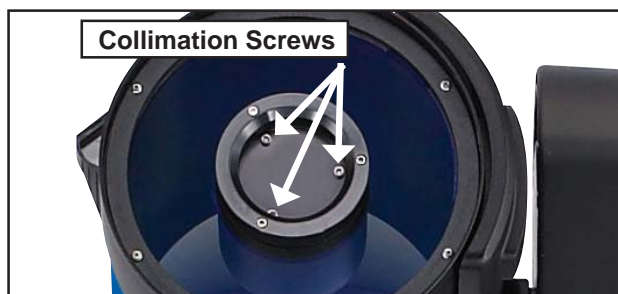

located at the inner surface of the secondary mirror housing.

**CAUTION: Do not force the three collimation screws past their normal travel and do not loosen them more than two full turns in a counterclockwise direction or the secondary mirror may come loose from its support. You will find that the adjustments are very sensitive, usually requiring only one-half turn or less to produce the desired result.**

2. While looking at the defocused star image, notice which direction the darker shadow is offset in the ring of light or notice which part of the ring is the thinnest (Pg. 32 Fig. 8, 1). Place your index finger in front of the telescope so that it touches one of the collimation set screws. You will see the shadow of your finger in the ring of light. Move your finger around the edge of the black plastic secondary mirror support until you see the shadow of the finger crossing the thinnest part of the ring of light. At this point, look at the front of the telescope where your finger is aiming. It will either be pointing directly at a set screw, or it will be between two set screws aiming at the set screw on the far side of the black plastic secondary mirror support. This is the set screw that you will adjust.
3. Using the Arrow keys at the slowest slew speed, move the defocused image to the edge of the

eyepiece field of view (Fig. 8, 2), in the same direction as the darker shadow is offset in the ring of light.

4. Turn the set screw that you found with the pointing exercise while looking in the eyepiece. You will notice that the star image will move across the field. If while turning the defocused star image flies out of the eyepiece field, then you are turning the screw the wrong way. Turn the opposite direction and bring the image back to the center of the field.
5. If the screw you are turning becomes very loose, tighten the other two screws by even amounts. If the screw you are turning gets too tight, un-thread the other two by even amounts.
6. When you bring the image to center (Fig. 8, 3), carefully examine the evenness of the ring of light (concentricity). If you find that the dark center is still off in the same direction, continue to make the adjustment in the original turning direction. If it is now off in the opposite direction, you have turned too far and you need to turn in the opposite direction. Always double check the image in the center of the field of the eyepiece.
7. You may find after your initial adjustment that the dark center is off in a new direction (e.g., instead of being off side-to-side it is now off in an up-and-down direction). In this case repeat steps 2 through 6 to find the new adjustment screw.
8. Now try a higher power eyepiece (e.g., 9mm or less) and repeat the above tests. Any lack of collimation at this point will require only very slight adjustments of the three set screws. You now have good collimation of the optics.
9. As a final check on alignment, examine the star image in focus with the higher power eyepiece as suggested above, under good viewing conditions. The star point should appear as a small central dot (commonly referred to as an "Airy disc") with a diffraction ring surrounding it. To give a final precision collimation, make extremely slight adjustments of the three set screws, if necessary, to center the Airy disc in the diffraction ring. You now have the best alignment of the optics possible with this telescope.

## Inspecting the Optics

**A Note About the “Flashlight Test”:** If a flashlight or other high-intensity light source is pointed down the main telescope tube, the view (depending upon the observer’s line of sight and the angle of the light) may reveal what appears to be scratches, dark or bright spots, or just generally uneven coatings, giving the appearance of poor quality optics. These effects are only seen when a high intensity light is transmitted through lenses or reflected off the mirrors, and can be seen on any high quality optical system, including giant research telescopes.

The optical quality of a telescope cannot be judged by the “flashlight test;” the true test of optical quality can only be conducted through careful star testing.

## Gauging the Movement of the Telescope

A common complaint of many first-time telescope owners is that they cannot see the telescope “move” when the motor drive is engaged. In fact, when the batteries are installed, the power is on, the telescope is moving. However, the movement is at the same speed as the hour hand of a 24-hour clock; as such, the movement is difficult to discern visually.

To check the movement of your telescope, look at an astronomical object through the telescope’s eyepiece with the telescope polar aligned and with the motor drive on. If the object remains stationary in the field of view, your telescope is operating properly. If not, check to ensure that “Astronomical” is selected in the “Targets” option of the setup menu.

## Updating Your LS Firmware

Meade is constantly refining and improving the operating firmware that controls our computerized telescopes and we even add new features and capabilities from time to time. Your new LS shipped with the most current firmware at the time of manufacture, but there may well be a new version available through the AutoStar Updated program supplied on the AutoStar Suite DVD

supplied with your telescope. The Updater goes online to the Meade web site and checks to see if there is a newer version available and can download it directly to the telescope through a user supplied USB cable or it can create a bootable Mini SD Card that, when inserted into the telescope’s Mini SD Card slot (**Pg. 12, Fig. 3, 10**), will transfer the files to the telescope on startup. Please see the AutoStar Suite documentation for details on how to perform the update.

Here are the steps to update your firmware:

1. Install AutoStar Suite software and the USB driver from the DVD included with the telescope.
2. Attach telescope with user supplied USB cable or insert a mini SD card or micro SD in mini holder into a card reader to internet connected computer.
3. Turn on the LS and press “**MODE**” to abort from the alignment.
4. Run AutoStar Suite
5. Select the “Telescope” menu from the menu bar near the top of the screen.
6. Select “Product Updates” from the drop down menu.
7. Click “OK” or “Yes” in the message box to be sure you have the latest version of the Updater software.
8. If you see “Error Box” about searching for COM Ports and you have your telescope connected with a USB cable, click “Yes”. If you are using an SD Card, click “No”.
9. Click on “Upgrade AutoStar Software Now”.
10. Open the drop down menu called “Specify Type of AutoStar...”.
11. Select LS.
12. If you want to make an Mini SD Card, check the SD box.
13. Click “OK” and the firmware will download and install.

## LS Mini SD Card for Updates and Image Storage

Your LS telescope comes with a “Mini SD Card” slot located in the front edge of the fork arm. With a user supplied “Mini SD Card”, or a “Micro SD Card” in a Mini Card Adapter, you can update your telescope firmware or save images made with the ECLIPS CCD.

Only use SD Cards bearing the official SD logo. Each card must be properly formatted, using a PC utility or AutoStar Suite, before use in the LS. The card must be formatted with the FAT32 File System.

Your LS will not power-up with an SD Card inserted in its slot unless you are updating the firmware from the card. This includes an SD Card used to store images from the ECLIPS camera. To ensure the application software boots normally, remove the SD Card before switching on the LS LightSwitch. If you observe that the LS is taking a long time to power-up, please ensure the Mini SD Card slot is empty and cycle the LS LightSwitch off and on.

## CUSTOMER SERVICE

If you have a question concerning your LS telescope, call the Meade Instruments Customer Service Department at (800) 626-3233. Customer Service hours are 7:00 AM to 5:00 PM, Pacific Time, Monday through Friday. In the unlikely event that the LS requires factory servicing or repairs, before returning the telescope to the factory, write or call the Meade Customer Service Department to provide an explanation of the problem, as well as your name, address and daytime telephone number. The great majority of servicing issues can be resolved by telephone, avoiding return of the telescope to the factory.



# APPENDIX A: TRAINING THE DRIVE

Perform this procedure if you are experiencing any pointing accuracy problems. Fig. 9 depicts the complete Drive Training procedure.

**NOTE:** Use a terrestrial object, such as a telephone pole or lamp post, to train the drive.

Complete this exercise once every 3 to 6 months.

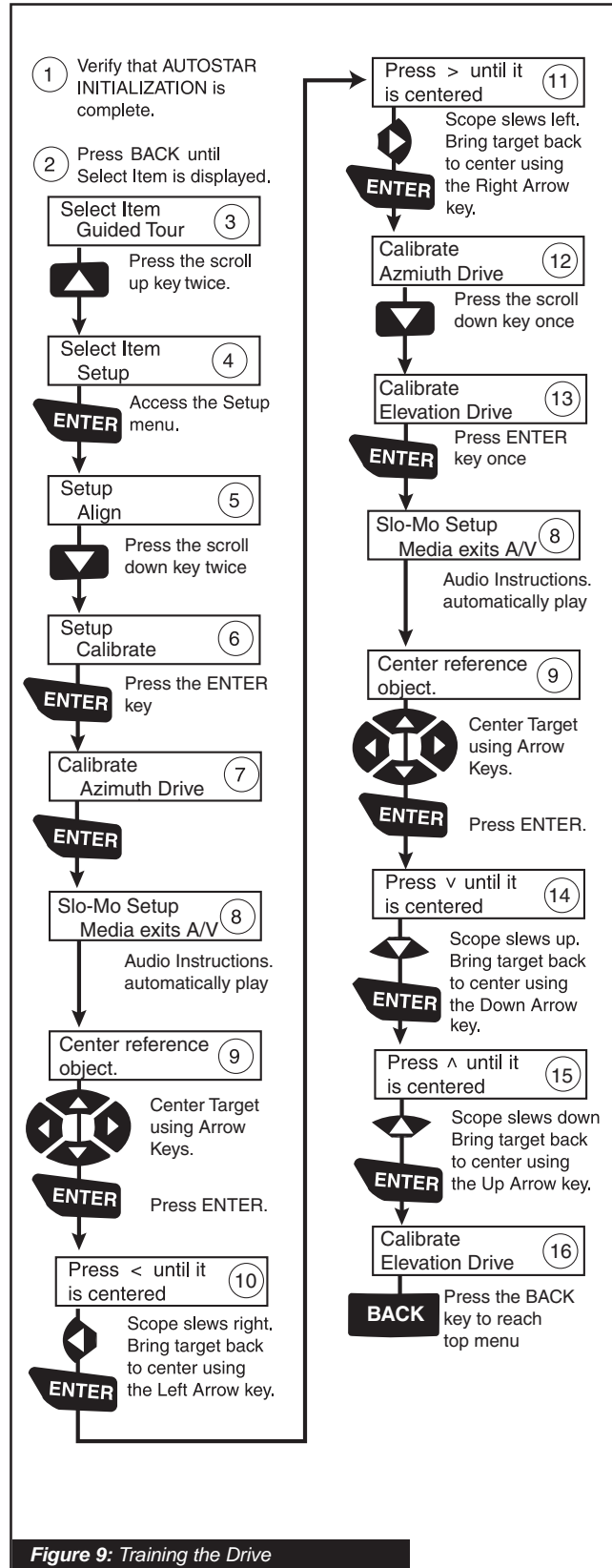

Figure 9: Training the Drive

## APPENDIX B: CREATING USER OBJECTS and TOURS

**User Object** are catalogs of deep sky objects you can create or import that are not in the LS telescope. You can define your own objects and create your own titles.

**Tours**, similar to the three preloaded guided tours (Tonight's Best", "A Star's Life" and "How Far Is Far"), can also be created. You can choose your own theme and objects.

For complete instructions on how to use the authoring tools to create tours, user objects and load your own files please refer to the reference manual included on the AutoStar Suite DVD.

## APPENDIX C: BASIC ASTRONOMY

In the early 17th century Italian Scientist Galileo, using a crude telescope considerably smaller than the LS, turned it to look towards the sky instead of distant trees and mountains. What he saw, and what he realized about what he saw, forever changed the way mankind thought of the universe. Imagine what it must have been like being the first human to see moons revolve around the planet Jupiter or to see the changing phases of Venus! Because of his observations, Galileo correctly realized Earth's movement and position around the Sun, and in doing so, gave birth to modern astronomy. Yet Galileo's telescope was so crude, he could not clearly make out the rings of Saturn.

Galileo's discoveries laid the foundation for understanding the motion and nature of the planets, stars, and galaxies. Building on his foundation, Henrietta Leavitt determined how to measure the distance to stars; Edwin Hubble proposed a glimpse into the origin of the universe; Albert Einstein unraveled the relationship of time and light. Almost daily, using sophisticated successors to Galileo's crude telescope, such as the Hubble Space Telescope, more and more mysteries of the universe are being solved and understood. We are living in a golden age of astronomy.

Unlike other sciences, astronomy welcomes contributions from amateurs. Much of the knowledge we have on subjects such as comets, meteor showers, variable stars, the Moon and our solar system comes from observations made by amateur astronomers. So as you look through your Meade LS telescope, keep Galileo in mind. To him, a telescope was not merely a machine made of glass and metal, but something far more - a window through which the beating heart of the universe might be observed.

### Objects in Space

Listed below are some of the many astronomical objects that can be seen with the LS



**The Moon** is, on average, a distance of 239,000 miles (380,000km) from Earth and is best observed during its crescent or half phase when Sunlight strikes the Moon's surface at an angle. It casts shadows and adds a sense of depth to the view. No shadows are seen during a full Moon, causing the overly bright Moon to appear flat and rather uninteresting through the

telescope. Be sure to use a neutral Moon filter when observing the Moon. Not only does it protect your eyes from the bright glare of the Moon, but it also helps enhance contrast, providing a more dramatic image.

Using the LS, brilliant detail can be observed on the Moon, including hundreds of lunar craters and maria, described below.

**Craters** are round meteor impact sites covering most of the Moon's surface. With no atmosphere on the Moon, no weather conditions exist, so the only erosive force is meteor strikes. Under these conditions, lunar craters can last for millions of years.

**Maria** (plural for mare) are smooth, dark areas scattered across the lunar surface. These dark areas are large ancient impact basins that were filled with lava from the interior of the Moon by the depth and force of a meteor or comet impact.

Twelve Apollo astronauts left their bootprints on the Moon in the late 1960's and early 1970's. However, no telescope on Earth is able to see these footprints or any other artifacts. In fact, the smallest lunar features that may be seen with the largest telescope on Earth are about one-half mile across.

**Planets** change positions in the sky as they orbit around the Sun. To locate the planets on a given day or month, consult a monthly astronomy magazine, such as *Sky and Telescope* or *Astronomy*. You can also consult LS for information about planets. Scroll to the “Object: Solar System” menu and scroll through the lists of planets. When a planet you are interested in displays, press “ENTER”. Use the Scroll keys to display information about the planet, such as the planet’s coordinates, and the rise and set times (Tip: enter a date in the Date menu and you can determine if a planet) will be visible during the night of the entered date by checking its rise and set times). Listed below are the best planets for viewing through the LS.

**Mars** is about half the diameter of Earth, and appears through the telescope as a tiny reddish-orange disk. It may be possible to see a hint of white at one of the planet’s Polar ice caps. Approximately every two years, when Mars is closest to Earth in its orbit, additional detail and coloring on the planet’s surface may be visible.



**Jupiter** is the largest planet in our solar system and is 11 times the diameter of Earth. The planet appears as a disk with dark lines stretching across the surface. These lines are cloud bands in the atmosphere. Four of Jupiter’s 16 moons (Io, Europa, Ganymede, and Callisto) can be seen as “star-like” points of light when using even the lowest

magnification. These moons orbit Jupiter so that the number of moons visible on any given night changes as they circle around the giant planet.



**Saturn** is nine times the diameter of Earth and appears as a small, round disk with rings extending out from either side. In 1610, Galileo, the first person to observe Saturn through a telescope, did not understand that what he was seeing were rings. Instead, he believed that Saturn had “ears.” Saturn’s rings are composed of billions of ice particles

ranging in size from a speck of dust to the size of a house. The major division in Saturn’s rings, called the Cassini Division, is occasionally visible through the LS. Titan, the largest of Saturn’s 18 moons can also be seen as a bright, star-like object near the planet.

### Deep-Sky Objects

Star charts can be used to locate constellations, individual stars and deep-sky objects.

Examples of various deep-sky objects are given below:

**Stars** are large gaseous objects that are self-illuminated by nuclear fusion in their core. Because of their vast distances from our solar system, all stars appear as pinpoints of light, irrespective of the size of the telescope used.

**Nebulae** are vast interstellar clouds of gas and dust where stars are formed. Most impressive of these is the Great Nebula in Orion (M42), a diffuse nebula that appears as a faint wispy gray cloud. M42 is 1600 light years from Earth.

**Open Clusters** are loose groupings of young stars, all recently formed from the same diffuse nebula. The Pleiades is an open cluster 410 light years away. Through the LS, numerous stars are visible.



## SPECIFICATIONS

<b>Model and Product Number</b>	<b>6"LS-6 ACF # 0610-03-10</b>
<b>Optical System</b>	
Optical Design	Advanced Coma-Free (ACF)
Primary Mirror Diameter	6" (152mm)
Primary Mirror Material	Pyrex® Glass
Focal Length, Focal Ratio	1524mm, f/10
Optical Coatings	Ultra-High Transmission Coatings (UHTC™)
Resolving Power (arc seconds)	0.76
<b>Mount</b>	
Mount Type	Aluminum Single-Arm Fork Altazimuth
Drives	4.875 inch Precision Worm Drive
Power	8 "C" Cell Batteries or AC Adapter
Battery Life	3 to 5 Hours
Tripod	New Adjustable-height Steel Leg Tripod
<b>Electronics</b>	
Controller Hand Box	AutoStar III
Processor	400 megahertz Blackfin
Memory	256 Megabytes of NAND Flash
Storage	Mini SD Card (user supplied)
Input/Output	USB 2.0
Speaker	Built-in Mount
Connections	USB, AutoStar Hand Box
<b>Multimedia</b>	
Content	Descriptions of the Planets, Moon, Stars, Clusters, Nebulae, Galaxies and More
Audio	Over 4 Hours Featuring the Voice of Sandy Wood from "Star Date"
Video	30 Minutes of Movies and Animations Plus Hundreds of Still Images

## SPECIFICATIONS

<b>Model and Product Number</b>	<b>6" LS-6 SC # 0610-03-12</b>
<b>Optical System</b>	
Optical Design	Schmidt Cassegrain (SC)
Primary Mirror Diameter	6" (152mm)
Primary Mirror Material	Pyrex® Glass
Focal Length, Focal Ratio	1524mm, f/10
Optical Coatings	Ultra-High Transmission Coatings (UHTC™)
Resolving Power (arc seconds)	0.76
<b>Mount</b>	
Mount Type	Aluminum Single-Arm Fork Altazimuth
Drives	4.875 inch Precision Worm Drive
Power	8 "C" Cell Batteries or AC Adapter
Battery Life	3 to 5 Hours
Tripod	New Adjustable-height Steel Leg Tripod
<b>Electronics</b>	
Controller Hand Box	AutoStar III
Processor	400 megahertz Blackfin
Memory	256 Megabytes of NAND Flash
Storage	Mini SD Card (user supplied)
Input/Output	USB 2.0
Speaker	Built-in Mount
Connections	USB, AutoStar Hand Box
<b>Multimedia</b>	
Content	Descriptions of the Planets, Moon, Stars, Clusters, Nebulae, Galaxies and More
Audio	Over 4 Hours Featuring the Voice of Sandy Wood from "Star Date"
Video	30 Minutes of Movies and Animations Plus Hundreds of Still Images

## SPECIFICATIONS

<b>Model and Product Number</b>	<b>8"LS-8 ACF # 0810-03-10</b>
<b>Optical System</b>	
Optical Design	Advanced Coma-Free (ACF)
Primary Mirror Diameter	8" (203.2mm)
Primary Mirror Material	Pyrex® Glass
Focal Length, Focal Ratio	2000mm, f/10
Optical Coatings	Ultra-High Transmission Coatings (UHTC™)
Resolving Power (arc seconds)	0.57
<b>Mount</b>	
Mount Type	Aluminum Single-Arm Fork Altazimuth
Drives	4.875 inch Precision Worm Drive
Power	8 "C" Cell Batteries or AC Adapter
Battery Life	3 to 5 Hours
Tripod	New Adjustable-height Steel Leg Tripod
<b>Electronics</b>	
Controller Hand Box	AutoStar III
Processor	400 megahertz Blackfin
Memory	256 Megabytes of NAND Flash
Storage	Mini SD Card (user supplied)
Input/Output	USB 2.0
Speaker	Built-in Mount
Connections	USB, AutoStar Hand Box
<b>Multimedia</b>	
Content	Descriptions of the Planets, Moon, Stars, Clusters, Nebulae, Galaxies and More
Audio	Over 4 Hours Featuring the Voice of Sandy Wood from "Star Date"
Video	30 Minutes of Movies and Animations Plus Hundreds of Still Images

## SPECIFICATIONS

<b>Model and Product Number</b>	<b>8" LS-8 SC # 0810-03-12</b>
<b>Optical System</b>	
Optical Design	Schmidt Cassegrain (SC)
Primary Mirror Diameter	8" (203.2mm)
Primary Mirror Material	Pyrex® Glass
Focal Length, Focal Ratio	2000mm, f/10
Optical Coatings	Ultra-High Transmission Coatings (UHTC™)
Resolving Power (arc seconds)	0.57
<b>Mount</b>	
Mount Type	Aluminum Single-Arm Fork Altazimuth
Drives	4.875 inch Precision Worm Drive
Power	8 "C" Cell Batteries or AC Adapter
Battery Life	3 to 5 Hours
Tripod	New Adjustable-height Steel Leg Tripod
<b>Electronics</b>	
Controller Hand Box	AutoStar III
Processor	400 megahertz Blackfin
Memory	256 Megabytes of NAND Flash
Storage	Mini SD Card (user supplied)
Input/Output	USB 2.0
Speaker	Built-in Mount
Connections	USB, AutoStar Hand Box
<b>Multimedia</b>	
Content	Descriptions of the Planets, Moon, Stars, Clusters, Nebulae, Galaxies and More
Audio	Over 4 Hours Featuring the Voice of Sandy Wood from "Star Date"
Video	30 Minutes of Movies and Animations Plus Hundreds of Still Images

## APPENDIX E:

### FEDERAL COMMUNICATIONS COMMISSION

#### DECLARATION OF CONFORMITY (DoC)

FOR THE FOLLOWING EQUIPMENT:

PRODUCT NAME : MEADE LS SERIES TELESCOPE

MODEL NO : ETX-LS

TRADE NAME : MEADE INSTRUMENTS CORP.

IS HERE WITH CONFIRMED AND FOUND TO COMPLY WITH THE REQUIREMENTS OF CFR47 PART 15 REGULATION. THE RESULTS OF ELECTROMAGNETIC EMISSION EVALUATION ARE SHOWN IN THE REPORT NO.: MEADE-0811106, ISSUED ON DECEMBER 10, 2008.

THIS DEVICE COMPLIES WITH PART 15 OF THE FCC RULES. OPERATION IS SUBJECT TO THE FOLLOWING TWO CONDITIONS:

- (1) THIS DEVICE MAY NOT CAUSE HARMFUL INTERFERENCE AND,
- (2) THIS DEVICE MUST ACCEPT ANY INTERFERENCE RECEIVED, INCLUDING INTERFERENCE THAT MAY CAUSE UNDESIRE

OPERATION.

THE FOLLOWING MANUFACTURER/IMPORTER IS RESPONSIBLE FOR THIS DECLARATION:

MEADE INSTRUMENTS CORP.

27 HUBBLE

IRVINE, CA. 92618 U.S.A.

(Tel) 800-626-3233

(Name) Bob LaTouche (Title) Director of Quality



(Date) DECEMBER 03, 2009



Industry Industrie  
Canada Canada

This Class B digital apparatus  
complies with Canadian  
ICES-003. Cet appareil  
numérique de la classe B est  
conforme à la norme NMB-003  
du Canada.





## RECYCLING INFORMATION

(EU Countries only)



### Correct Disposal of this Product

#### (Waste Electrical & Electronic Equipment)

This marking shown on the product or its literature indicates that it must not be disposed of in unsorted municipal waste at the end of its working life

To prevent possible harm to the environment or human health from uncontrolled waste disposal, please separate this from other types of wastes and recycle it as required by law. Household users should contact either the retailer where they purchased this product, or their local government office, for details of where and how they can take this item for environmentally safe recycling.

Business users should contact their supplier and check the terms and conditions of the purchase contract

This product should not be mixed with other commercial wastes for disposal.

# MEADE LIMITED WARRANTY

Every Meade telescope, spotting scope, and telescope accessory is warranted by Meade Instruments Corporation ("Meade") to be free of defects in materials and workmanship for a period of ONE YEAR from the date of original purchase in the U.S.A. and Canada. Meade will repair or replace a product, or part thereof, found by Meade to be defective, provided the defective part is returned to Meade, freight-prepaid, with proof of purchase. This warranty applies to the original purchaser only and is non-transferable. Meade products purchased outside North America are not included in this warranty, but are covered under separate warranties issued by Meade international distributors.

**RGA Number Required:** Prior to the return of any product or part, a Return Goods Authorization (RGA) number must be obtained from Meade by writing, or calling (800) 626-3233. Each returned part or product must include a written statement detailing the nature of the claimed defect, as well as the owner's name, address, and phone number.

This warranty is not valid in cases where the product has been abused or mishandled, where unauthorized repairs have been attempted or performed, or where depreciation of the product is due to normal wear-and-tear. Meade specifically disclaims special, indirect, or consequential damages or lost profit which may result from a breach of this warranty. Any implied warranties which cannot be disclaimed are hereby limited to a term of one year from the date of original retail purchase.

This warranty gives you specific rights. You may have other rights which vary from state to state.

Meade reserves the right to change product specifications or to discontinue products without notice.



**MEADE**<sup>®</sup>

27 Hubble, Irvine, California 92618  
(800) 626-3233 ■ [www.meade.com](http://www.meade.com)

14-7302-06 REV2



## Free Manuals Download Website

<http://myh66.com>

<http://usermanuals.us>

<http://www.somanuals.com>

<http://www.4manuals.cc>

<http://www.manual-lib.com>

<http://www.404manual.com>

<http://www.luxmanual.com>

<http://aubethermostatmanual.com>

Golf course search by state

<http://golfingnear.com>

Email search by domain

<http://emailbydomain.com>

Auto manuals search

<http://auto.somanuals.com>

TV manuals search

<http://tv.somanuals.com>