

Instruction Manual

ETX-80AT-BB Backpack Observatory



MEADE.COM



MEADE®

CONTENTS



WARNING!

Never use a Meade® Telescope to look at the Sun! Looking at or near the Sun will cause instant and irreversible damage to your eye. Eye damage is often painless, so there is no warning to the observer that damage has occurred until it is too late. Do not point the telescope or its viewfinder at or near the Sun. Do not look through the telescope or its viewfinder as it is moving. Children should always have adult supervision while observing.

CAUTION: Use care to install batteries in the orientation indicated by illustration in the battery slots of the battery holder. Follow battery manufacturer's precautions. Do not install batteries backwards or mix new and used batteries. Do not mix battery types. If these precautions are not followed, batteries may explode, catch fire, or leak. Improperly installed batteries void your Meade warranty.

If you are anxious to use your telescope for the first time, read the QUICK-START GUIDE on page 4.

Quick-Start Guide	4
Telescope Features	6
AutoStar® Features	10
Getting Started	13
Parts Listing	13
Telescope/Tripod Assembly	13
Stowing Your Gear in the Backpack	14
Safety Precautions	14
Choosing an Eyepiece	15
Manual Operation of the Telescope w/out AutoStar ..	15
Manual Operation of the Telescope with AutoStar ..	16
Slew Speeds	16
Observe the Moon	17
To Track an Object Automatically	17
Moving Through AutoStar's Menus	17
Initializing AutoStar	17
Easy Alignment	19
Go To Saturn	19
Using the Guided Tour	20
AutoStar Menus	21
Menu Tree	21
AutoStar Operation	22
AutoStar Navigation Exercise	22
Entering Data, Moving Through AutoStar's Menus ..	23
Objects Menu	24
Event Menu, Glossary Menu	25
Utilities Menu	25
Setup Menu	26
Advanced AutoStar Operation	29
Terrestrial Observing, Astronomical Observing	29
Sidereal Rate	29
Advanced Alt/Az Alignment Methods	29
Observing Satellites	30
Digital Photography with the ETX®	31
Optional Accessories	33
Maintenance	34
Troubleshooting	35
Specifications	36
Appendix A: Using AutoStar to Enter Coordinates	38
Appendix B: Latitude Chart	39
Appendix C: Training the Drive	40
Appendix D: Basic Astronomy	41

® The name "Meade," the Meade logo, and "ETX" are trademarks registered with the U.S. Trademark and Patent Office and in principal countries throughout the world. All rights reserved.

Patents: US 6,392,799 and other patents pending.

© 2005 Meade Instruments Corporation.

QUICK-START GUIDE



Step 2a: Loosen the locking ring....



Step 2b: ...and push down as far as it will go to open tripod.

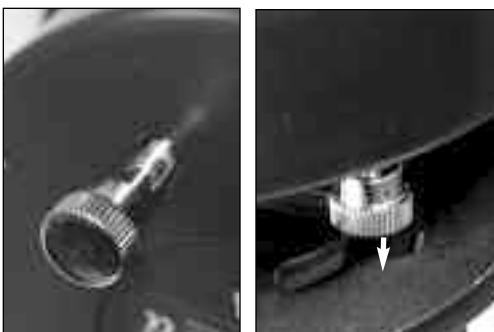

Step 6: Attach bolts and thread into key-like holes.



Step 7: Loosen vertical lock to move optical tube.

Setting up the Tripod

Step 1: Remove the telescope and tripod from the giftbox.

Step 2: Hold the tripod by its handle and turn the locking ring to loosen the tripod mechanism. Push down on the locking ring as far as it will go to spread out the tripod legs. Turn the locking ring to tighten the tripod in place.

Step 3: You can adjust the height of the tripod, by lifting a leg lock lever and sliding the inner leg in or out to the desired length. Then re-tighten the lock. Repeat for the other two legs.

Step 4: Use the tripod on level and even ground. Pointing accuracy depends on the base of the tripod being level with the horizon. The bubble level on top of the tripod can help determine if the base is level: Move the base until the bubble is in the center of the circle.

Attach the Telescope to the Base

Step 5: Thread the supplied bolts about two or three turns through the underside of the telescope base.

Step 6: Line up the bolts over the key-like holes on the base of the tripod and slide the bolts into the holes. Rotate the telescope clockwise until the bolts fit into the hole bays. Then, reach under the tripod base and tighten the bolts to a firm feel.

Step 7: Loosen the vertical lock and move the optical tube downward. Then, re-tighten the vertical lock.

Step 8: Remove the inverted dewshield from the end of the telescope. Unthread the dust cover to remove from the scope. Thread the dewshield over the end of the telescope.

Step 9: Remove the eyepiece caps from the 90 degree eyepiece holder and the rear cell port. Screw on the 45 degree prism to the rear cell port. You can put two eyepieces into this telescope at the same time.

Step 10 : Slip a lower power eyepiece, such as a 25mm or 26 mm eyepiece into the 45 degree prism and another eyepiece into the 90 degree holder.

You can switch between the two eyepieces by turning the flip mirror control to the up or down position.



Step 13: Focus insert batteries.



Step 14: Plug in handbox and turn on computer control panel.



Step 17: Sight along the top of the optical tube.

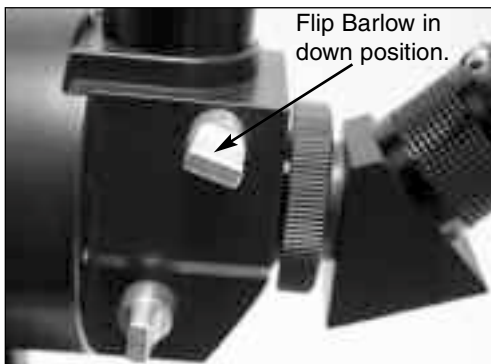

Note: Flip Barlow control in the "down" position.

Step 11 :Secure the eyepieces in place with their respective thumbscrews. Always start observing using a low power eyepiece to get a nice widefield of view. Later on you can change to high power, if so desired. But high powered eyepieces have a much narrower field of view and it's more difficult to locate objects using high powered eyepieces.

Step 12 :You can focus the eyepieces by turning the focus knob. The focus knob has a very fine focus, so you may have to turn the knob 20 complete turns or more to focus on an object.

Connect the AutoStar Handbox

Step 13: Lift the battery cover. Gently remove the battery holder from the compartment so you don't accidentally pull out the wires attached to the holder. Insert 6 user supplied "AA" batteries in the holder. Refer to the diagram on the holder to orient the batteries properly. Replace the holder back into the battery compartment and replace the lid.

Step 14: Make sure that the computer control panel power switch is in the OFF position. Remove AutoStar from the packing materials and plug it into the HBX port.

Flip the Power Switch on the computer control panel to the ON position. The copyright message lights on AutoStar's LCD display.

Step 15: Press the key prompted by AutoStar to accept the Sun warning.

Observe

Step 16: You can now use the AutoStar Arrow keys to move the telescope up, down, right, or left. To change the telescope's slew speed, briefly press the Speed/? key. Each press decreases the slew speed down one level, and then will cycle back to the fastest speed.

Step 17: Sight along the side of the telescope's main tube to locate an object. At first, practice during the daytime using the AutoStar's Arrow keys to center on objects in the telescope's field of view. Observe trees, mountains, signs and so forth. Then when you're comfortable locating objects in this manner, try at night on the Moon, planets and stars.

Note about the Flip Barlow: To use the built-in 2x Barlow, rotate the the Flip Barlow control so that it is in the down position (see diagram, left). The Flip Barlow doubles the magnification of your eyepiece.

If you use the Flip Barlow, you will need to turn the focus knob in a counterclockwise direction. You may have to turn the focus knob 20 or more turns to focus with the Barlow engaged.

TELESCOPE FEATURES

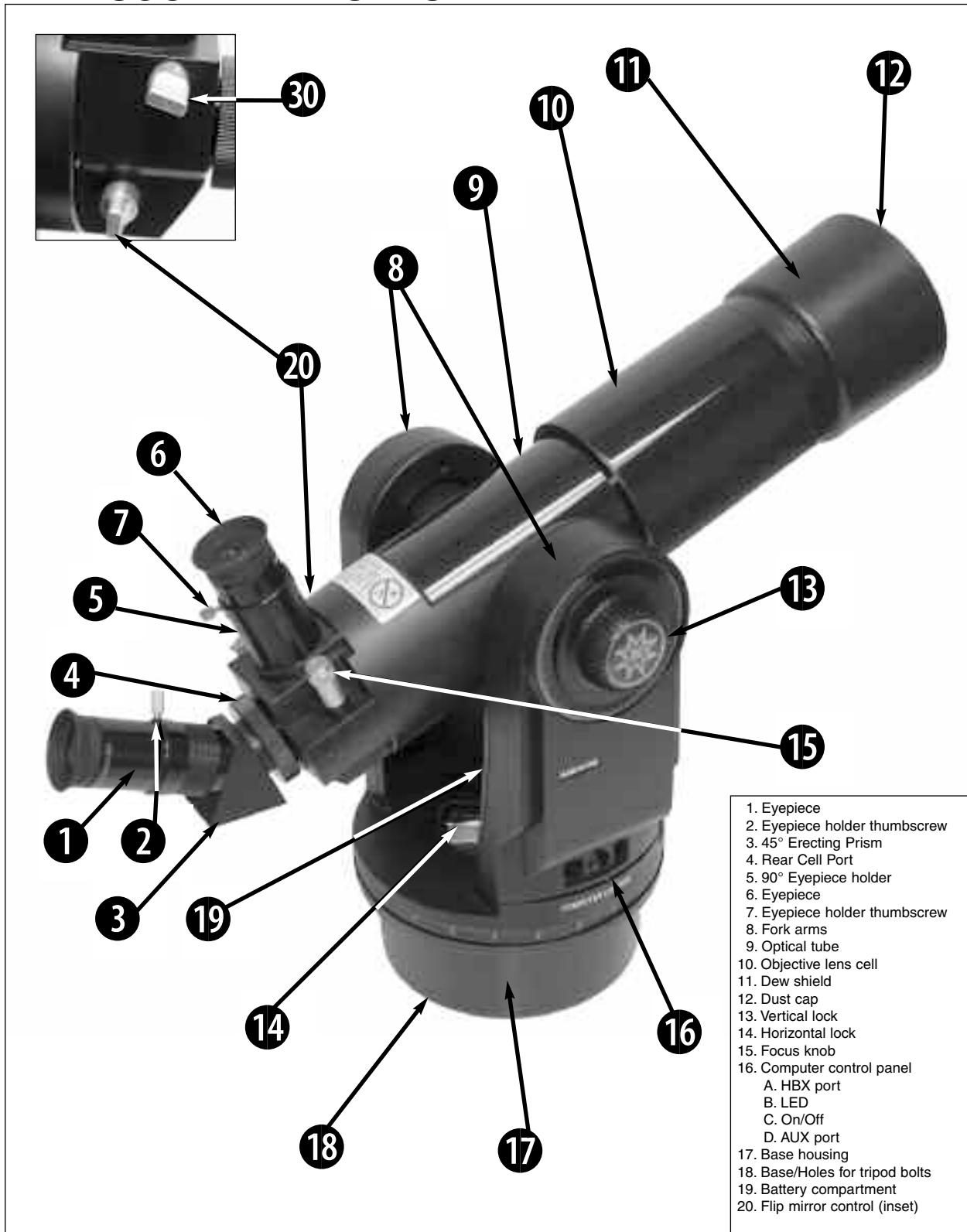

Fig. 1: The ETX-80AT-BB Telescope.

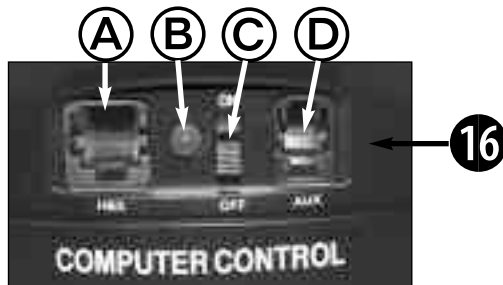

Fig. 1b : The computer control panel:
A - HBX port; B - LED; C - On/Off;
D - AUX port.



Fig. 1c: The battery compartment.



Fig. 2: The AutoStar Handbox (see page 10).

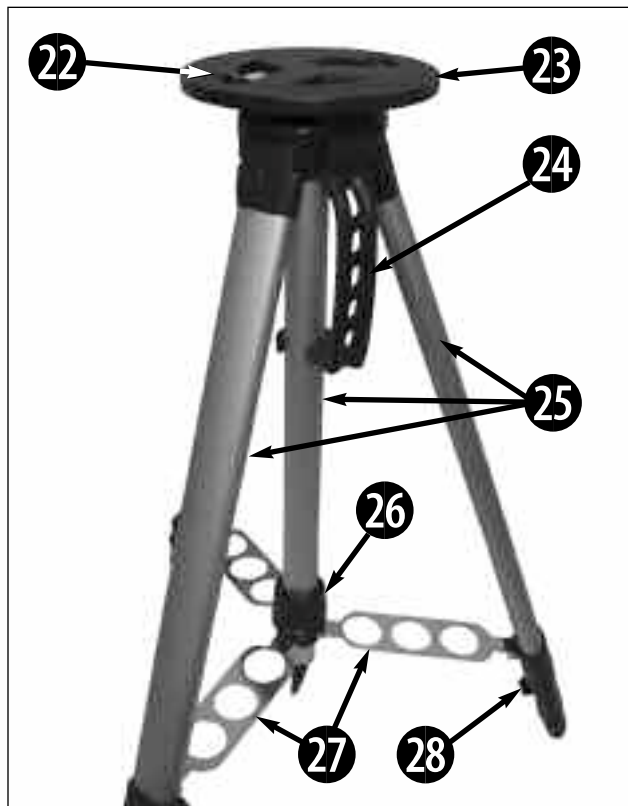
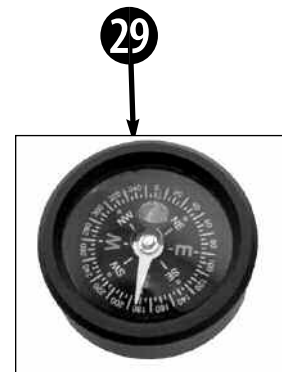

Fig. 3: The tripod.



- 21. AutoStar
- 22. Tripod bubble level
- 23. Base
- 24. Handle
- 25. Adjustable legs
- 26. Locking ring
- 27. Leg braces/accessory holders
- 28. Leg locks
- 29. Bubble level/compass
- 30. Flip Barlow

ETX: Your Personal Window to the Universe

The Meade ETX-80AT-BB is an extremely versatile, high-resolution telescope with features similar to those once available only with larger and more specialized imaging systems. With push-button controls, automatic tracking of celestial objects, and software downloading capability, an ETX telescope may be all the telescope ever required by many terrestrial and astronomical observers.

Caution:

Using products other than standard Meade accessories may cause damage to the telescope's internal electronics and may void the Meade warranty.

Your ETX telescope reveals nature in an ever-expanding level of detail. Observe the feather structure of an eagle from 50 yards or study the rings of the planet Saturn from a distance of 800 million miles. Focus beyond the Solar System and observe majestic nebulae, ancient star clusters, remote galaxies, and even stars recently discovered to have planets orbiting about them. Meade ETX telescopes are instruments fully capable of growing with your interest and are ideal for both the casual observer and serious astronomer alike.

- ❶ **1 Eyepiece:** Place the MA 25mm or other eyepiece into the 45° Eyepiece Holder (3, Fig. 1) and tighten in place with thumbscrew (2, Fig.1).
- ❷ **2 Eyepiece Holder Thumbscrew:** Secures the eyepiece. Tighten to a "firm feel" only.
- ❸ **3 45° Erecting Prism:** Holds the eyepiece at angle for convenient viewing and correctly orients images in the eyepiece.
- ❹ **4 Rear Cell Port:** Attach any 35mm camera with a removable lens to this port using an optional #64ST T-Adapter or attach the 45° prism (3, Fig. 1) for correctly oriented images through the eyepiece.
- ❺ **5 90° Eyepiece Holder:** Holds the eyepiece upright for easy viewing.
- ❻ **6 Eyepiece:** Place the MA 25mm or other eyepiece into the 90° Eyepiece Holder (5, Fig. 1) and tighten in place with thumbscrew (7, Fig.1).
- ❼ **7 Eyepiece Holder Thumbscrew:** Secures the eyepiece. Tighten to a "firm feel" only.
- ❽ **8 Fork Arms:** Hold the optical tube in place.
- ❾ **9 Optical Tube:** The main optical component that gathers the light from distant objects and brings this light to a focus at the eyepiece.
- ❿ **10 Movable Objective Lens Cell:** This component contains the telescope's lenses. The focus knob (15, Fig. 1) moves the cell for precise image focus.
- ⓫ **11 Dew Shield:** Slows down the advance of dew, which distorts observing conditions.
- ⓬ **12 Dust Cap:** Unthread the dust cap counterclockwise from the front lens of the telescope before observing.

Note: The dust cap should be replaced after each observing session and the power turned off to the telescope. Verify that any dew that might have collected during the observing session has evaporated before you replace the dust cap.
- ⓭ **13 Vertical Lock:** Turning the vertical lock counterclockwise unlocks the telescope, enabling it to be freely moved up and down. Turning the vertical lock clockwise (tighten to a "firm feel" only) prevents the telescope from being moved manually, but allows the vertical motor drive to operate for AutoStar operation.

Caution: When loosening the vertical lock, be sure to hold onto the optical tube (9, Fig. 1). The weight of the objective lens could cause the tube to swing suddenly downward and damage the telescope.
- ⓮ **14 Horizontal Lock:** Controls the manual horizontal rotation of the telescope. Turning the horizontal lock counterclockwise unlocks the telescope, allowing it to be freely rotated by hand side-to-side about the horizontal axis. Turning the horizontal lock clockwise prevents the telescope from being rotated manually, but allows the horizontal motor drive to operate for AutoStar operation.

- 15 **Focus Knob:** Moves the telescope's objective lens (10, Fig. 1) in a finely-controlled motion to focus an image. The ETX-80AT-BB telescope can be focused on objects from a distance of about 17 ft. to infinity. Rotate the focus knob clockwise to focus on distant objects, and counterclockwise to focus on nearby objects.

Note: The first time you focus the telescope, you may have to rotate the focus knob 20 to 40 complete turns as this is a fine focus mechanism which allows you to focus an image very precisely.

- 16 **Computer Control Panel:**

- A. **Handbox (HBX) Port:** Plug the AutoStar coil cord (8, Fig. 5) into this port.
- B. **LED:** The red power indicator light illuminates when power is supplied to the AutoStar handbox and to the telescope's motor drive.
- C. **ON/OFF Switch:** Turns the Computer Control Panel and AutoStar ON or OFF.
- D. **Auxiliary (AUX) Port:** Provides connection for current and future Meade accessories, such as the Meade "AstroFinder Software with Cable Connector Kit," which allows you to control your ETX from a PC. See **OPTIONAL ACCESSORIES**, page 33.



Fig. 4a: Flip mirror control in the "up" position.

- 17 **Base Housing:** Contains mechanical and electrical assemblies that operate the telescope.
- 18 **Base/Bolt Hole for Tripod Bolts:** Thread the tripod bolts up through the tripod and into the two holes in the base.
- 19 **Battery Compartment:** Install batteries in this compartment. See Step #12, page 14 for more information.
- 20 **Flip Mirror Control:** ETX telescopes include an internal mirror. With the flip mirror control in the "Up" position, light is diverted to the eyepiece in the 90° eyepiece holder (5, Fig. 1). With the flip mirror control in the down position, light is diverted through the rear cell port (4, Fig. 1) for use with the the 45° prism and eyepiece or to a camera for photography. See **Figs. 4a and 4b**.



Fig. 4b: Flip mirror control in the "down" position.

- 21 **AutoStar with attached cord:** See pages 10 to 12 for a description of AutoStar's features.

The Tripod

- 22 **Bubble Level:** Use when aligning your telescope. When the bubble is in the center circle, the base is level.
- 23 **Base:** Attach the telescope to the base.
- 24 **Handle:** Conveniently placed for lifting and moving the tripod.
- 25 **Adjustable Tripod legs:** Support the telescope. The height of the legs can be adjusted. See 28 below.
- 26 **Locking Ring:** To open the tripod, loosen the ring and push it down as far as it will go. Tighten the ring to lock the tripod in an open position. To close tripod, loosen the ring and begin to pull upward. Close the legs against the center post (be careful not to close on your fingers). Tighten ring to fasten legs in the closed position.
- 27 **Leg Braces/Accessory holders:** Strengthens the legs when the tripod is in the open position. Also, you can place eyepieces and other accessories in the holes on the tray.
- 28 **Leg Locks:** Lift the lever to move the inner tripod leg segment in or out when adjusting the height of the tripod.
- 29 **Bubble Level:** Helps you level the tripod and to find North during the alignment procedure.
- 30 **Flip Barlow:** Flip the switch to engage the Barlow. The Barlow doubles the magnification of your eyepiece. You may have to turn the focus knob several times to refocus. See page 15 for more information.

AUTOSTAR FEATURES

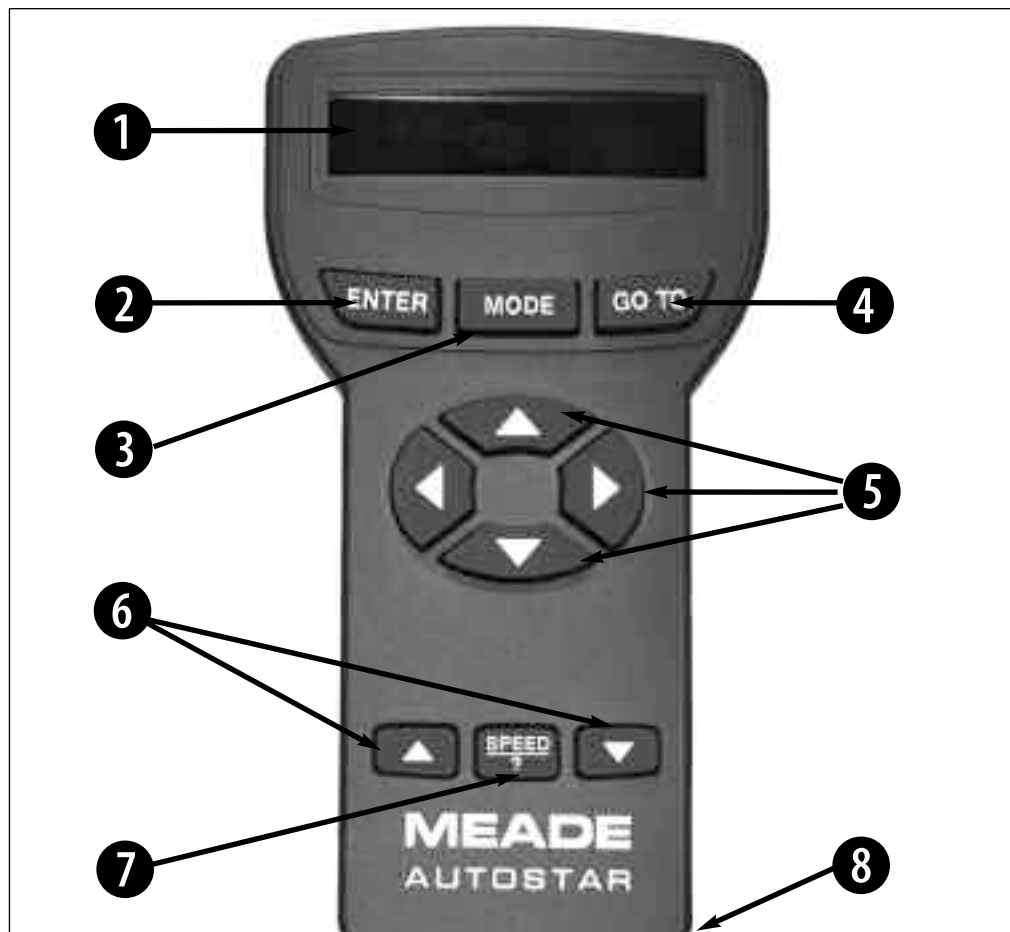

Fig. 5: #494 AutoStar Handbox.

Tour the Cosmos with Just the Push of a Button

Control of the ETX-80AT-BB is through the operation of the standard-equipment #494 AutoStar. Nearly all functions of the telescope are accomplished with just a few pushes of AutoStar's buttons. Some of the major features of AutoStar are:

- Automatically move the telescope to any of the 1400 objects stored in the database or manually enter the astronomical coordinates of any celestial object.
- Take a guided tour of the best celestial objects to view on any given night of the year.
- Download the latest satellite data and software revisions directly from the Meade website (www.meade.com) and share software with other AutoStar enthusiasts. (Requires optional #506 AstroFinder™ Software and Cable Connector Kit. See **OPTIONAL ACCESSORIES** page 33.)
- Access a glossary of astronomical terms.
- Calculate which eyepiece to use for optimum viewing of a celestial object.
- Mount the telescope in the "Alt/Az" mode (Altitude - Azimuth, or vertical - horizontal) for fully automatic tracking of celestial objects.

The AutoStar Computer Controller provides control of virtually every telescope function within a compact handbox. AutoStar has soft-touch keys designed to have a positive feel. The LCD (Liquid Crystal Display) is backlit with a red LED (Light Emitting Diode) for easy viewing in the dark. The backlit display, key arrangement, and sequential database make AutoStar extremely user friendly.

Note: AutoStar does not require batteries; the telescope's batteries supply power to AutoStar.

- ❶ **2-Line LCD Display:** Provides a visual interface between AutoStar and the telescope.
 - **Top line:** Displays a menu item, or a menu option.
 - **Bottom line:** Displays a menu option or information about a subject.
- ❷ **ENTER Key:** Accesses the AutoStar menus. See **MOVING THROUGH AUTOSTAR'S MENUS**, page 17 and **AUTOSTAR'S MENUS**, page 21. The ENTER key is similar to the Return key on a computer.

Note: If ENTER is pressed for two seconds or more and then released, AutoStar emits a beep and "ENTER to Sync" is displayed. "ENTER to Sync" is relevant only after the telescope has been aligned and is pointing at an object. If the "ENTER to Sync" feature is accessed by mistake, press MODE to return to the previous screen. See **HIGH PRECISION**, page 28, for more details about this feature.

- ❸ **MODE Key:** Returns to the previous menu. If you keep pressing Mode, it will continue to access previous menus until the top level, "Select Item," is reached. The MODE key is similar to the ESCAPE key on a computer.

NOTE: If MODE is pressed and held for two seconds or more, the following information is then available using the Scroll keys (6 , Fig. 5):

- Right Ascension and Declination (astronomical) coordinates (see **APPENDIX A**)
- Altitude (vertical) and Azimuth (horizontal) coordinates
- Local Time and Local Sidereal Time (LST)
- Timer and Alarm Status

Press MODE again to return to the previous menu.

- ❹ **GO TO Key:** Moves the telescope to the coordinates of the currently selected object. While the telescope is moving (or "slewing"), the operation may be stopped at any time by pressing any key except GO TO. Pressing GO TO again resumes the slew to the object.
- ❺ **Arrow Keys:** Move the telescope up, down, left and right, at one of nine different speeds. Speed selection is explained in **SLEW SPEEDS**, page 16. The following functions are available with the Arrow keys:

- **Alt/Az Alignment** - Use the Up and Down Arrow keys to move the telescope vertically up and down. The Left Arrow key rotates the telescope (horizontally) counterclockwise, while the Right Arrow key rotates it clockwise.
- **Data Entry** - Use the Up and Down Arrow keys to scroll through the letters of the alphabet and numerical digits. The Down Arrow key starts with the letter "A" and the Up Arrow key starts with the digit "9." The Left and Right Arrow keys are used to move the blinking cursor left and right across the LCD display.

- ❻ **Scroll Keys:** Accesses menu options within a selected menu. The menu is displayed on the first line of the screen. Options within the menu are displayed, one at a time, on the second line. Press the Scroll keys to move through a list of options. Press and hold a Scroll key to move quickly through the options.

The Scroll keys, like the Arrow keys, also scroll through the letters of the alphabet and numerical digits.

NOTE: The Scroll Down key and the Down Arrow key move forward through the alphabet & digits (A to Z, 0 to 9). The Scroll Up key and the Up Arrow key move backward (Z to A, 9 to 0). Common symbols are also available in the list.

NOTE:

Throughout this manual, you will notice the term "Alt/Az." Alt/Az stands for altitude-azimuth, which is just a fancy way of saying the telescope moves up and down, and from side to side. Not all telescopes move like this. Alt/Az alignment is just one of many methods used by amateur astronomers to help locate stars in the night sky.

- ⑦ **Speed/? Key:** Pressing the Speed/? key cycles through the nine slew speeds that move the telescope. Each time the Speed/? key is pressed briefly, the current slew speed is shown for about two seconds on the display. See **SLEW SPEEDS**, page 16.

The Speed/? key also accesses the "Help" file. "Help" provides on-screen information on how to accomplish whatever task is currently active.

***NOTE:** Pressing the Speed/? key very briefly changes the slew speed. Holding down the Speed/? key longer (one to two seconds) accesses the Help function.*

Hold down the Speed/? key and then follow the prompts on the display to access details of AutoStar functions in the Help feature. The Help system is essentially an on-screen instruction manual.

If you have a question about an AutoStar operation, *e.g.*, INITIALIZATION, ALIGNMENT, *etc.*, hold down the Speed/? key and follow the directions that scroll on the second line of the LCD screen. When a word appears in [brackets], press ENTER to access the AutoStar Glossary. A definition or more detailed information is displayed. Press MODE to return to the scrolling AutoStar Help display.

When satisfied with the Help provided, press MODE to return to the original screen and continue with the chosen procedure.

- ⑧ **Coil Cord (not visible in diagram):** Plug the AutoStar coil cord into the HBX port (A, Fig. 1) of the computer control panel of the telescope.



TIPS FOR BEGINNERS

Join an Astronomy Club Attend a Star Party

One of the fun ways to learn about astronomy is to join an astronomy club. Check your local newspaper, school, library, or telescope dealer/store to find out if there's a club in your area.

At club meetings, you will meet other astronomy enthusiasts with whom you will be able to share your discoveries. Clubs are an excellent way to learn more about observing the sky, to find out where the best observing sites are, and to compare notes about telescopes, eyepieces, filters, tripods, and so forth.

Often, club members are excellent astrophotographers. Not only will you be able to see examples of their art, but you may even be able to pick up some "tricks of the trade" to try out on your ETX telescope. See page 31 for more information about photography with the ETX.

Many groups also hold regularly scheduled Star Parties at which you can check out and observe with many different telescopes and other pieces of astronomical equipment. Magazines such as *Sky & Telescope* and *Astronomy* print schedules for many popular Star Parties around the United States and Canada.

GETTING STARTED

Parts Listing

Getting the telescope ready for first observations requires only a few minutes. When first opening the packing box, note carefully the following parts:

- The ETX Astro Telescope with fork mount system, photographic type tripod.
- Water-resistant backpack.
- #494 AutoStar handbox with attached coil cord.
- Meade premium eyepieces; 45° erecting prism.
- Hex-wrench, packed with the instruction manual. See **GENERAL MAINTENANCE** page 34.

Telescope Assembly

Setup The Tripod

Your backpack observatory does not ship with the parts stowed in the backpack. Before stowing the gear in the backpack and taking it out into the field, assemble the telescope in a familiar environment to practice the setup.

1. Hold the tripod by its handle and turn the locking ring to loosen the tripod mechanism (**Fig. 6a**). Push down on the locking ring as far as it will go to spread out the tripod legs (**Fig. 6b**). Turn the locking ring to tighten the tripod in place.
2. Adjust the height of the tripod, by lifting one of the tripod leg lock levers and sliding the inner leg in or out to the desired length. Then press down on the lever to re-lock. Repeat for the other two legs.
3. Use the tripod on a level and even ground. Pointing accuracy depends on the base of the tripod being level with the horizon. The bubble level on top of the tripod can help determine if the base is level: Move the base until the bubble is in the center of the circle.

Attach the Telescope to the Base

4. Thread the supplied bolts about two or three turns through the underside of the telescope base (**Fig. 7**).
5. Line up the bolts over the key-like holes on the base of the tripod and slide the bolts into the holes (**Fig. 8**). Rotate the telescope clockwise until the bolts fit into the hole bays. Then, reach under the tripod base and tighten the bolts to a firm feel.
6. The optical tube is shipped with the tube upright between the forks. Loosen the vertical lock (**Fig. 9**) and move the optical tube down between the fork arms. Then, re-tighten the vertical lock.
7. Remove the inverted dewshield from the end of the telescope. Remove the dust cap from the end of the telescope by rotating it counterclockwise. Then thread the dewshield over the end of the telescope.
8. Remove the eyepiece cap from the 90 degree eyepiece holder and also the cap from the rear cell port. Screw on the 45 degree prism to the rear cell port.
9. You can put two eyepieces into this telescope at the same time: Slip a lower power eyepiece, such as a 25mm or 26 mm eyepiece into the 45 degree prism and another eyepiece into the 90 degree holder. You can switch between the two eyepieces by turning the flip mirror control to the up or down position.

Note: It is strongly recommended that you remove the 45 degree prism from the telescope during the alignment procedure. The prism can correct the orientation of land objects during the daytime, but is not necessarily needed for astronomical viewing. You may use it, but during alignment the prism might strike the telescope base and obstruct the align process.



Fig. 6a: Loosen the tripod's locking ring...



Fig. 6b: ...push down as far as it will go.



Fig. 7: Thread bolts into telescope base.



Fig. 8: Line up bolts over keylike holes.



Fig. 9: Loosen vertical lock to move optical tube.



Fig 10. Focus knob.

10. Secure the eyepieces in place with their respective thumbscrews.

Tip: Always start observing using a low power eyepiece to get a nice wide field of view. Later on you can change to high power, if so desired. But high powered eyepieces have a much narrower field of view and it's more difficult to locate objects using high powered eyepieces.

11. You can focus the eyepieces by turning the focus knob.

Tip: The focus knob has a very fine focus, so you may have to turn the knob 20 complete turns or more to focus on an object.



Fig 11. Insert batteries.

Connect the AutoStar Handbook

12. Lift the battery cover. Now gently remove the battery holder from the compartment so you don't accidentally pull out the wires attached to the holder. Insert 6 user supplied "AA" batteries in the holder. Refer to the diagram on the holder to orient the batteries properly. Replace the holder back into the battery compartment and replace the lid.
13. Make sure that the computer control panel power switch is in the OFF position. Remove AutoStar from the packing materials and plug it into the HBX port.
14. Flip the Power Switch on the computer control panel to the ON position. The copyright message lights on AutoStar's LCD display.
15. Press the key prompted by AutoStar to accept the Sun warning.



Fig 12. Plug AutoStar into the HBX port of the computer control panel.

Stowing your Gear in the Backpack

First disassemble the telescope assembly.

1. Loosen the vertical lock. Now move the tube to an upright position so that it is pointing straight up through the fork arms and re-tighten the vertical lock.
2. Loosen the bolts on the underside of the tripod base, rotate the telescope counterclockwise, and lift the telescope off of the tripod. Now remove the bolts from the base.
3. Unscrew the dew shield. Thread the dust cover over the end of the telescope. Then flip the dewshield over and place it over the end of the tube.
4. Next, close and lock the tripod: Hold the tripod by its handle and turn the locking ring to loosen the tripod mechanism.
5. Lift the locking ring as far as it will go. Turn the locking ring to tighten the tripod in place.

Caution: Be careful not to close the tripod legs on your fingers.

Now, place the accessories and telescope into the backpack.

6. Put the eyepiece container into the provided pouches in the accessory compartment with the "lip" at the top.
7. Place the bolts, prism into their respective pouches. Zip up the accessory compartment.
8. Stow the ETX telescope in your backpack. Use the velcro tape inside of the backpack to further secure it in place. Place the AutoStar handbox into the lower section of the pack.
9. Zip up the pack.
10. Slide the tripod under the loops on the pack so that the feet will face downward when you carry the pack. Secure the tripod using the loop lock: Hold the knot with one hand and move the lock down toward the tripod with your other hand.



Fig 13. Thread the dust cover onto the tube.



Fig 14. The dewshield.



Fig 15. Secure the telescope in the backpack using the velcro strap.

Safety Precautions

- Take care not to allow the telescope to be jolted severely while hiking.
- Try not to run for any significant distance. Don't toss the telescope in the pack on the ground. Excessive vibrations may damage the telescope.
- The backpack is made of water-resistant material, but isn't waterproof. Some areas, such as the zipper seam might allow rain to penetrate and cause damage to the telescope.

Choosing an Eyepiece

A telescope's eyepiece magnifies the image formed by the telescope's main optics. Each eyepiece has a focal length, expressed in millimeters, or "mm." The smaller the focal length, the higher the magnification. For example, an eyepiece with a focal length of 9mm has a higher magnification than an eyepiece with a focal length of 25mm.

Your telescope comes supplied with two standard eyepieces.

Low power eyepieces offer a wide field of view, bright, high-contrast images, and excellent eye relief during long observing sessions. To find an object with a telescope, always start with a low power eyepiece. When the object is located and centered in the eyepiece, you may wish to switch to a higher power eyepiece to enlarge the image as much as practical for prevailing seeing conditions.

***Note:** Seeing conditions vary widely from night-to-night and site-to-site. Turbulence in the air, even on an apparently clear night, can distort images. If an image appears fuzzy and ill-defined, back off to a lower power eyepiece for a more well-resolved image (Fig. 18a and 18b, page 18).*

The power, or magnification of a telescope is determined by the focal length of the telescope and the focal length of the eyepiece being used. To calculate eyepiece power, divide the telescope's focal length by the eyepiece's focal length. *E.g.*, Assume you are using a 25mm eyepiece. The focal length of the ETX-80AT-BB is 400mm (see **SPECIFICATIONS**, page 36).

Telescope Focal Length ÷ Eyepiece Focal Length = Magnification

$$400\text{mm} \div 25\text{mm} = 16$$

The eyepiece power, or magnification is therefore 16x. However, your telescope also contains a built-in 2 times Barlow. This means you also have to multiply magnification figure by two.

$$16 \times 2 = 32$$

So your telescope has a 32 times magnification.

Manual Operation of the Telescope without AutoStar

If you wish to observe a distant land object, such as a mountain top or a bird, you can observe by merely pointing the telescope and looking through the eyepiece. Assemble the telescope, loosen the horizontal and vertical locks (**13 and 14, Fig. 1**), and turn the telescope towards the object you wish to observe. Sight along the top of the tube until you find the object. When the object appears in the eyepiece, focus the image using the by turning the focus knob (**15, Fig. 1**). Rotate the knob clockwise to focus on distant objects and counterclockwise to focus on nearby objects.

You can also observe stars and objects in the night sky using this method, but note that objects begin to slowly drift across the eyepiece field. This motion is caused by the rotation of the Earth. As you become familiar with AutoStar operation, you can counteract the drift using the automatic tracking feature in the Setup menu (see **TO TRACK AN OBJECT AUTOMATICALLY**, page 17), or by using AutoStar's GO TO capabilities (see **GO TO SATURN**, page 19).



Fig. 16: Sight along the top of the optical tube.



Fig. 17: AutoStar's Arrow keys.

Manual Operation of the Telescope Using AutoStar's Arrow Keys

You may also observe land and astronomical objects using AutoStar's Arrow keys.

If you have not already done so, prepare your telescope following the steps described in **TELESCOPE ASSEMBLY**, page 13. Next, flip the On/Off Switch (**16C, Fig. 1b**) on the computer control panel to the ON position. The copyright message lights on AutoStar's display. Press the Speed/? key (**7, Fig. 5**) to accept the Sun warning. The "Getting Started" message displays. Keep pressing the ENTER key until "Country/State" appears on the display. (Ignore the prompts requesting "Date" and "Time" for now – these functions will be explained later in the manual).

Use the Scroll keys to cycle through the database of countries/states. Press ENTER when your location displays. Next, use the Scroll keys to scroll to the nearest city to your observing site and press ENTER. Next, use the Scroll keys to scroll to your telescope model and press ENTER. The display then reads "Setup: Align."

You can now use the Arrow keys (**5, Fig. 5**) to slew (move) the telescope up, down, right, or left. To change the telescope's slew speed, briefly press the Speed/? key (**7, Fig. 5**). Each press decreases the slew speed down one level, and then cycles back to the fastest speed. See page 16 for more information.

Tighten (to a "firm feel" only, do not overtighten) the vertical and horizontal locks (**13 and 14, Fig. 1**). Sight along the side of the telescope's main tube to locate an object and practice using the AutoStar's Arrow keys to center the object in the telescope's field of view. Use the telescope's focus knob (**15, Fig. 1**) to bring the object into focus.

This procedure demonstrates just a very small part of AutoStar's capabilities. In the next section of this manual, you will begin to learn how to make use of AutoStar's extensive and powerful features.

Slew Speeds

AutoStar has nine slew speeds that are directly proportional to the sidereal rate (this is the speed at which stars move) and have been calculated to accomplish specific functions. Pressing the SPEED/? key changes the slew speed, which is then shown for about two seconds on AutoStar's display.

The nine available speeds are:

- Speed 1 = 2x = 2 x sidereal (0.5 arc-min/sec or 0.008°/sec)
- Speed 2 = 8x = 8 x sidereal (2 arc-min/sec or 0.033°/sec)
- Speed 3 = 16x = 16 x sidereal (4 arc-min/sec or 0.067°/sec)
- Speed 4 = 32x = 32 x sidereal (8 arc-min/sec or 0.13°/sec)
- Speed 5 = 64x = 64 x sidereal (16 arc-min/sec or 0.27°/sec)
- Speed 6 = 0.5° = 120 x sidereal (30 arc-min/sec or 0.5°/sec)
- Speed 7 = 1°/s = 240 x sidereal (60 arc-min/sec or 1°/sec)
- Speed 8 = 2°/s = 480 x sidereal (120 arc-min/sec or 2°/sec)
- Speed 9 = Max = (Maximum speed possible, dependent on battery power)

Speeds 1, 2, or 3: Best used for fine centering of an object in the field of view of a higher power eyepiece, such as a 12mm or a 9mm eyepiece.

Speeds 4, 5, or 6: Enables centering an object in the field of a low-to-moderate power eyepiece, such as a standard 25mm eyepiece.

Speeds 7 or 8: Best used for rough centering of an object in the eyepiece.

Speed 9: Moves the telescope quickly from one point in the sky to another.

Observe the Moon

Point your telescope at the Moon (note that the Moon is not visible every night) and practice using the Arrow keys and the slew speeds to view different features. The Moon contains many interesting features, including craters, mountain ranges, and fault lines. The best time to view the Moon is during its crescent or half phase. Sunlight strikes the Moon at an angle during these periods and adds a depth to the view. No shadows are seen during a full Moon, causing the overly bright surface to appear flat and rather uninteresting.

Consider the use of a neutral density Moon filter when observing the Moon. Not only does it cut down the Moon's bright glare, but it also enhances contrast, providing a more dramatic image.

To Track an Object Automatically

As the Earth rotates beneath the night sky, the stars appear to move from East to West. The speed at which the stars move is called the sidereal rate. You can setup your telescope to move at the sidereal rate so that it automatically "tracks" the stars and other objects in the night sky. In other words, if the telescope is not tracking an astronomical object, the object will drift out of the eyepiece field of view. The tracking function automatically keeps an object more or less centered in the telescope's eyepiece.

To track objects, you must first initialize AutoStar and then select "Targets: Astronomical" from the AutoStar Setup menu. You must also learn how the AutoStar keypad operates in order to move through the AutoStar menus.

Moving Through AutoStar's Menus

The AutoStar database is organized in levels for quick and easy navigation.

- Press ENTER to go deeper into AutoStar's menu levels.
- Press MODE to move back toward the top menu level.
- Use the Scroll keys to move up and down through the options available for each level.
- Use the Scroll keys to enter characters and digits.

The Arrow keys are used to move the telescope, and can also enter numbers and letters.

Initializing AutoStar

This section describes how to initialize AutoStar. Perform this procedure the first time you use AutoStar or after performing a RESET.

1. **Secure the locks:** Make sure that the vertical and horizontal locks (**13 and 14, Fig. 1**) are secured.
2. **Plug in AutoStar:** Connect AutoStar to the HBX port of the computer control panel (**16a, Fig. 1B**).
3. **Turn on the control panel:** Flip the telescope power switch of the computer control panel to the ON position.

The AutoStar screen is activated and a copyright message displays briefly, followed by a short beep. Then AutoStar takes a few moments to start up the system.

4. **Sun Warning:** A message displays that warns not to look at the Sun. At the end of this message, press the Speed/? key to signify that the message has been read and understood.
5. **Getting Started:** The Getting Started menu displays a scrolling message. Press ENTER (**2, Fig. 5**) to bypass the Help tutorial and continue with initialization.
6. **Daylight Savings Time:** The next screen requests the status of Daylight Savings Time. Press one of the Scroll keys to toggle between the YES/NO settings. When the desired setting displays, press ENTER.

Note: When multiple choices are available within a menu option, the option that is currently enabled is usually displayed first and highlighted by a right pointing Arrow (>).

NOTE:

AutoStar requests the Country/State, City, and Telescope Model information only the first time AutoStar is activated. If you wish to change this information, use the "Site" and "Telescope Model" options in the Setup menu.

Initialization is a procedure that ensures that AutoStar operates correctly. When you first use AutoStar, it doesn't yet know where the observation location site is, what your model number is (AutoStar operates with several different models of Meade telescopes) or if you are in a day-light savings time period.

During the procedure, you are requested to enter this information. AutoStar uses this information, plus time and date information it receives for a high-precision internal clock to precisely calculate the location of celestial objects, such as stars and planets, and how to move your telescope correctly for various operations.

You will only be asked for the location and model number information the first time you initialize AutoStar or after a reset. You can change this information (for example, you may move more than 50 miles away) by going to the Site and Telescope model options in the Setup menu.

7. **Set Your Location or Zip Code:** The Location screen displays. This screen asks you if you wish to choose either the zip code of your observing location or the location (*i.e.*, entering the city and state or country of your observing location). Press Up to select the zip code option or down to enter the city and state.
Note: The location settings (country/state/province and city, or zip code) are only asked for the first time you turn on the control panel. If you wish to change this setting later on, use the Site menu. See **SITE**, page 28, for more information.
 - a. If you chose the zip code option, the leftmost "0" is highlighted. Use the Scroll keys to scroll through the digits. When you reach the desired number, use the Right Arrow key to move to the next digit position. Repeat this process until all 5 digits of your zip code are entered. Press ENTER.
 - b. If you chose the location option, the next screen asks for the country or state/province (listed alphabetically) of the observing site. Use the Scroll keys to scroll through the list of countries, states, and provinces. Press ENTER when the correct location displays. The next screen asks for the city (listed alphabetically) closest to the observing site. Use the Scroll keys to scroll through the list of cities. Press ENTER when the correct city appears on screen.
8. **Select model number.** As AutoStar operates with several different models of telescopes, it next requests your telescope model number. Use the Scroll keys to cycle through the models. Press ENTER when your model number displays.
9. **System initialization is complete.** The Easy Alignment feature begins automatically after the control panel is initialized.



TIPS FOR BEGINNERS



Too Much Power?

Can you ever have too much power? If the type of power you're referring to is eyepiece magnification, yes, you can! The most common mistake of the beginning observer is to "overpower" his or her telescope by using high magnifications which the telescope's aperture and atmospheric conditions can not reasonably support. Keep in mind that a smaller, but bright and well-resolved image is far superior to one that is larger, but dim and poorly resolved (see below). Powers above 110X should be employed only under the steadiest atmospheric conditions.

AutoStar can calculate the best eyepiece for you to use. Try out the "Eyepiece Calc" feature in the Utilities menu.

Most observers should have three or four additional eyepieces to achieve the full range of reasonable magnifications possible with the ETX telescopes. See **OPTIONAL ACCESSORIES**, page 33.

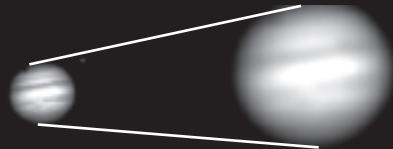

Fig. 18a & b: Jupiter; example of too much magnification.

Note:

The "Telescope: Mount" option of the Setup menu is set to "Alt/Az" as the default alignment by the factory. The example presented in this section assumes that you are performing an alignment procedure for the first time with your telescope and therefore, the "Telescope: Mount" option does not need to be selected.

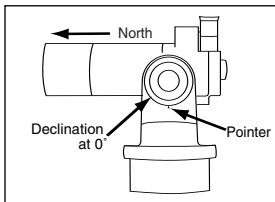

Fig. 19: Alt/Az Alignment Home Position.



Fig. 20: The ETX-80 is supplied with a bubble level. When setting the home position, use the bubble level to help level the telescope and to find North.

Remove the eyepiece from the 90° holder and drop in the bubble level. Adjust the telescope tube the bubble enters the center circle of the bubble level. Line up the North - South line of the compass with you telescope tube. Move the tube until the tube points North.

Easy Alignment

After you initialize the system, AutoStar displays "Easy Align." The fastest and easiest way to start observing with AutoStar is with Easy Alignment.

During Easy Alignment, AutoStar automatically picks two alignment stars from its database of celestial objects. It will then slew the telescope to a first alignment star. The user is asked to verify that the telescope is pointed at the chosen star and then to center the star in the eyepiece. The process is repeated with a second star to complete the alignment.

1. **Select Alignment:** "Align Easy" displays. Press ENTER.
2. **Set Home Position:** AutoStar then prompts you to set the telescope in the Alt/Az Alignment home position (see margin note and **Figs. 19 and 20**). To set your telescope in the "Alt/Az" home position:
 - Loosen the telescope's vertical lock (**13, Fig. 1**).
 - Level the optical tube with the horizon. Move the optical tube until the pointer points at "0" on the setting circle (**Fig. 19**).
 - Tighten the vertical lock to a "firm feel" only.
 - Unlock the horizontal lock (**14, Fig. 1**) and turn the telescope horizontally until it points North. Re-lock the horizontal lock.
 - Remove the 45° prism and eyepiece from the rear cell port. It may interfere with the alignment procedure. After alignment, you may replace the prism and eyepiece.
 - Press ENTER.
3. **Center Alignment Stars:** The AutoStar then slews to the first star for alignment. It may not appear in the field of view in the eyepiece. The alignment star should be easily recognized and be the brightest star in the area of the sky where the telescope is pointing. Use the Arrow keys to move the telescope until the star is visible and centered in the eyepiece. Press ENTER. Repeat procedure for the second alignment star.

NOTE: AutoStar locates alignment stars based on the date, time, and location entered. The alignment stars may change from night to night. All that is required is for the observer to center the selected stars in the eyepiece when prompted.

Note: The GO TO key also allows you to perform a "spiral search." A spiral search is useful when the telescope slews to an object, but that object is not visible in the eyepiece after the telescope finishes its search. (This sometimes occurs during an alignment procedure.) Press GO TO when the slew is finished and the telescope starts slewing in a spiral pattern at a very slow speed around the search area. Look through the eyepiece and when the object does become visible, press MODE to stop the spiral search. Then use the Arrow keys to center the object.

Go To Saturn

After performing the Easy Alignment procedure, the motor drive begins operating and the telescope is aligned for a night of viewing. Objects in the eyepiece should maintain their position even though the Earth is rotating beneath the stars.

IMPORTANT NOTE: Once aligned, only use the GO TO or Arrow keys to move the telescope. Do not loosen the telescope locks (**13 and 14, Fig. 1**), or move the base manually, or alignment will be lost.

This exercise demonstrates how to select an object for viewing from AutoStar's database. This example demonstrates how to select Saturn.

NOTE: Saturn is not visible the entire year and you may need to choose another object from AutoStar's database; however, the procedure, as described below, remains the same.

- 1 After the telescope is aligned, "Select Item: Object" displays. Press ENTER.
- 2 "Object: Solar System" displays. Press ENTER.
- 3 "Solar System: Mercury" displays. Keep pressing the Scroll Down key until "Solar System: Saturn" displays.

NOTE:

Keep in mind that when viewing through an eyepiece in the 90° eyepiece holder, images of terrestrial objects are right-side-up, but reversed left-for-right. Normally, such an image orientation is not bothersome, unless trying to read a distant sign, for example.

If you wish to use the telescope for terrestrial observation, use the eyepiece in the 45° prism. The image in this eyepiece will be correctly oriented.

4. Press ENTER. "Calculating" displays. Then "Saturn" and a set of coordinates displays. Saturn's (and other planets') coordinates change throughout the year.
5. Press GO TO. "Saturn: Slewing..." displays and the telescope slews until it finds Saturn. You may need to use the Arrow keys to center Saturn precisely in the eyepiece. AutoStar then automatically slews (moves) the telescope so that it "tracks" Saturn (or whatever other object you may have chosen); *i.e.*, Saturn remains centered in the eyepiece. If an object is observed in the telescope without using AutoStar's GO TO or automatic tracking capabilities, objects in the eyepiece gradually drift out of the field of view due to the Earth's rotation.

Using the Guided Tour

You've been hiking all day and night falls after you've set up camp. The only light is from the stars, which seem so close that you feel you can reach out and touch them. You've gotten your friends all excited about looking through your scope during the hike.

You initialize Autostar, set the home position and get aligned. You find Jupiter in the Solar System menu and you show off Jupiter's four moons and you talk about the detail you can see in the bands circling the giant planet.

Next, you choose Saturn from the Solar system menu and — Autostar displays "Below horizon." So you quickly pick out Mars from the menu. It's also below the horizon. Your friends are losing interest.

This is the perfect time to use Autostar's "Guided Tour."

Guided Tour is one of Autostar's more fun features. For example, check out the tour called "Tonight's Best." "Tonight's Best" will take you on a tour of the best objects in the sky. Objects that are in the sky right now—the tour changes all the time depending on the time, date and place.

1. To find the Guided Tour menu, keep pressing MODE until "Select Item: Object" displays.
2. Press one of the Scroll keys to page through the menus. Keep pressing until "Select Item: Guided Tour" displays.
3. Press ENTER. "Guided Tour: Tonight's Best" displays. Press ENTER.
4. "Tonight's Best: Searching..." displays. After calculating, "Tonight's Best: Jupiter" might displays—different objects may be displayed on a tour list on any given night.
5. Press ENTER to display information about an object. Even though you may have just looked at Jupiter, read the information screens (use the scroll keys to page through these screens). You may discover some cool information you didn't know about Jupiter.
6. Press MODE to return to the Tour list of objects. Press one of the Scroll keys to scroll through the list. Press ENTER when you find the next object you wish to observe; press ENTER to select the object. Then press GO TO to move the telescope to that object. Repeat this procedure to find other objects.
7. Press and hold down MODE for two seconds to leave the Guided Tour menu.

TIPS FOR BEGINNERS

Which One's the Alignment Star?

If AutoStar has chosen an alignment star with which you are unfamiliar, how can you be sure if the star in your eyepiece is really the alignment star?

The rule of thumb is that an alignment star is usually the brightest star in that area of the sky. When you view an alignment star in an eyepiece, it stands out dramatically from the rest of the stars in that portion of the sky.

If you have an obstruction, such as a tree or a building blocking your view of the alignment star, or if you have any doubts at all about the star that has been chosen, no problem. Just press the Scroll Down key and AutoStar will find another star to align upon.

AUTOSTAR MENUS

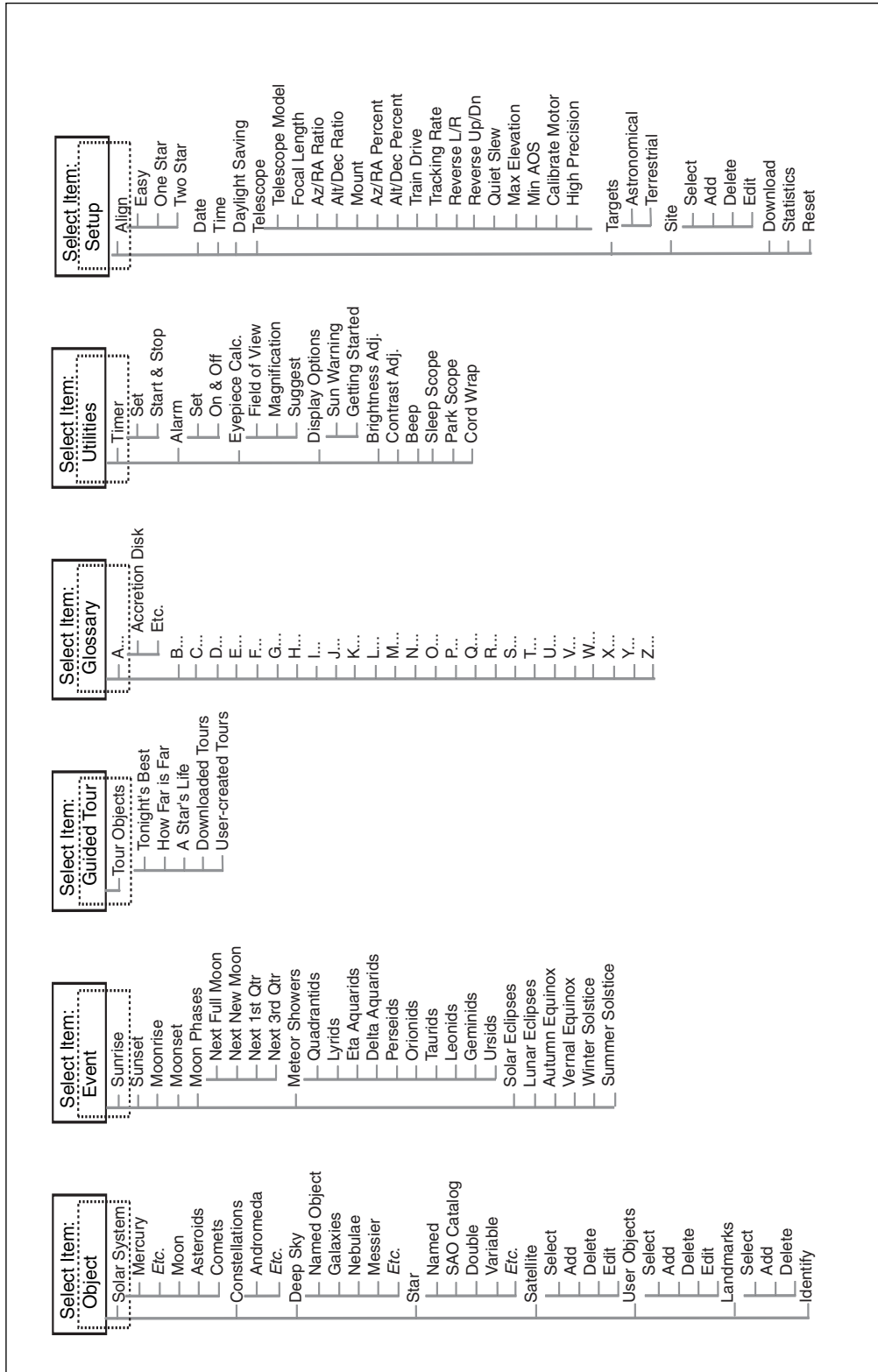

Fig. 21 The Complete AutoStar Menu Structure.

AUTOSTAR OPERATION

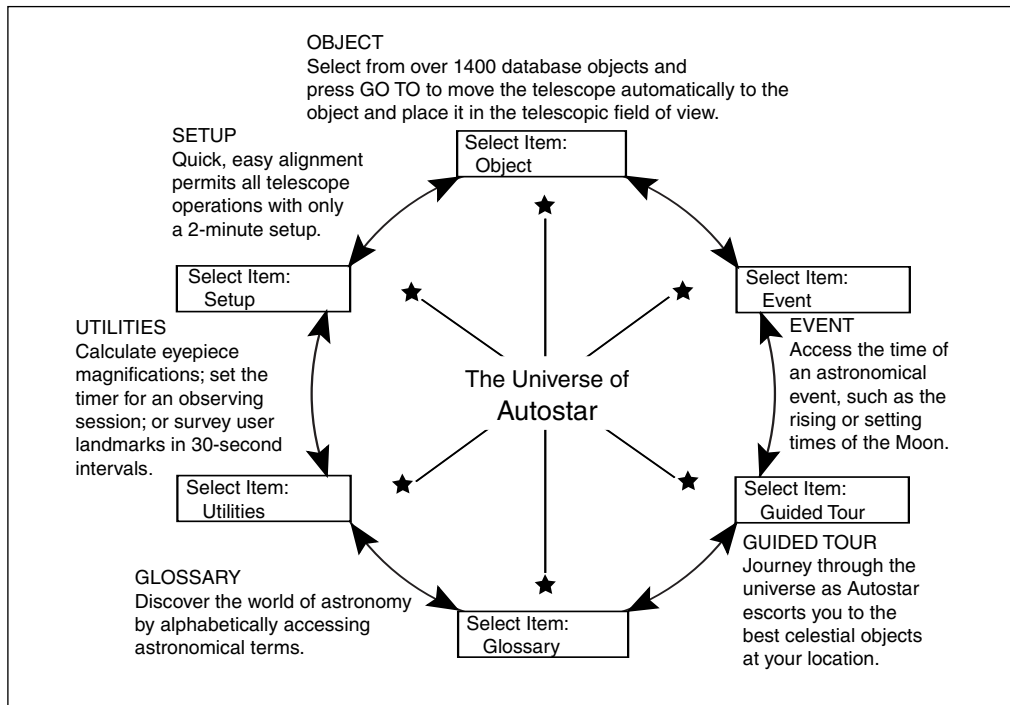

Fig. 22: The AutoStar Universe: The six primary categories listed in the Select Item menu of AutoStar.

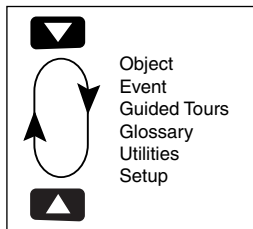

Fig. 23: Menus set in a loop.

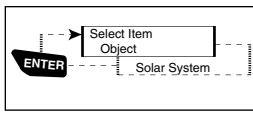

Fig. 24: AutoStar menu levels.

It is important to understand that menu selections are set in a loop (**Fig. 23**). This means that pressing the Scroll Down key (**6, Fig. 5**) cycles down through all the available options within a given category, then returns to the first option. The Scroll Up key (**6, Fig. 5**) cycles up through the options in the opposite order. Note that this capability is a quick way to get to an option that is near the bottom of the list. The following example demonstrates this capability.

Example:

To navigate to the “Select Item: Setup” menu option when the “Select Item: Object” menu is displayed:

1. Press the Scroll Down key four times or the Scroll Up key once.

The screen in **Fig. 24** displays two lines of information. The top line shows the current menu level. The second line displays an option which may be selected within that menu level. Some options are choices that select the next menu level down. The Scroll keys move up and down within the list of available options, showing one option at a time.

When the desired option is displayed on the second line, press the ENTER key to choose that option and move down one menu level.

Press the MODE key to leave a level; e.g., the wrong menu option is chosen.

IMPORTANT NOTE: No matter how many levels into AutoStar are traveled, each press of the MODE key moves up a level, until the top level, “Select Item,” is reached. Once in the Select Item level, press MODE to return to the topmost level, “Select Item: Object.”

AutoStar Navigation Exercise

To demonstrate how the AutoStar menu structure works, the following exercise calculates Sunset time so an evening observing session can be planned.

NOTE: To perform an accurate calculation, AutoStar must be properly initialized with the current date, time, and location of the observing site. To enter the current date, time, and location information of your observing site, see **INITIALIZING AUTOSTAR**, page 17, before proceeding with this exercise.

To Calculate Sunset time:

1. Press the MODE key several times, until "Select Item: Object" is displayed.
2. Press the Scroll Down key once to display the "Event" option in the "Select Item" menu.
3. Press the ENTER key to choose the "Event" option and move down a level. "Event: Sunrise" is displayed.
4. Press the Scroll Down key once to display the "Sunset" option in the Event menu.
5. Press the ENTER key to choose the "Sunset" option and move down another level.
6. Autostar calculates the Sunset time based on the current date, time, and location. Autostar then displays the results of the calculation.
7. Press MODE once to start moving back up through the Autostar levels. The first level up is the Event menu.
8. Press MODE again to move up another level. This is the top level, "Select Item."
9. Press MODE again to return to the starting point of "Select Item: Object."

Entering Numbers and Text into Autostar

To enter numbers and text:

- Use the Up and Down Arrow keys to scroll through numbers 0 - 9 and the alphabet. The Down Arrow key begins with the letter "A;" the Up Arrow key begins with digit "9."

To move the cursor across the display:

- Use the Right or Left Arrow key (**5, Fig. 5**) to move the cursor from one number to the next in the display
- Press ENTER when the desired information has been entered.

Navigating Autostar

Autostar's menus are organized for quick and easy navigation:

- Press ENTER to go deeper into Autostar's menu levels.
- Press MODE (**3, Fig. 5**) to move back toward the top menu level.
- Press the Scroll keys to move up and down through the options or lists
- Press the Arrow keys to move the cursor across the display.
- Press the Help (?) key to access on-line help.

Adjusting the Speed of a Scrolling Message

- Press and hold the Scroll Up key to increase the scrolling speed when a message is scrolling across the display.
- Press and hold the Scroll Down key to decrease the scrolling speed when a message is scrolling across the display.

TIP: When multiple choices are available within a menu option, the option that is currently selected is usually displayed first and highlighted by a right pointing arrow (>).

Object Menu

Almost all observing with Autostar is performed using the Object menu category. (**NOTE: Exceptions include Guided Tour and Landmark Survey.**) See **GO TO SATURN**, page 19, for an example of observing using the Object menu. Also see **TAKE A GUIDED TOUR**, page 20.

Many Autostar menu categories contain databases. An Autostar *database* is a list of viewable objects, such as stars, planets, comets, nebulae, and so forth. When one of these objects is selected from a database, Autostar moves your telescope (if properly aligned) and points it at the selected object.

The Object Menu options include:

Solar System is a database of the eight planets (Earth is not included) in order out from the Sun, followed by the Moon, asteroids, and comets.

Constellation is a database of all 88 Northern and Southern Hemisphere constellations. When this menu option is chosen and a constellation name appears on the first line of the screen, press GO TO once to change the second line to the name of the brightest star in the constellation. Press GO TO a second time to slew the telescope to that star. Use the Scroll keys to cycle through the list of stars in the constellation, from brightest to dimmest.

Deep Sky is a database of objects outside our Solar System such as nebulae, star clusters, galaxies, and quasars.

Star is a database of stars listed in different categories such as named, double, variable, or nearby.

Satellite is a database of Earth-orbiting objects such as the International Space Station, the Hubble Space Telescope, Global Positioning System (GPS) satellites, and geosynchronous orbit satellites.

User Objects allows the user to define and store in memory deep-sky objects of specific interest that are not currently in the Autostar database. See "Appendix B" for more information.

Landmarks stores the location of terrestrial points of interest in the permanent Autostar database.

IMPORTANT NOTE: *To use the Landmark function, the telescope must be located and aligned exactly as when the landmark was added to the database.*

- **Select:** To select a Landmark already in the database (see **ADD** below), choose the "Select" option and scroll through the list. Press ENTER to select a Landmark, then press GO TO and the telescope slews to the object.
- **Add:** To add a Landmark, choose the "Add" option. Enter a name for the Landmark. Locate and center the Landmark in the eyepiece, then press ENTER.

Identify is an exciting feature for an observer who wants to scan the night sky and start exploring. After the telescope has been properly aligned, use the Autostar Arrow keys to move about in the sky. Then follow this procedure:

IMPORTANT NOTE: *Only use the Arrow keys to move the telescope during the Identify procedure. Do not loosen the telescope locks or move the base or alignment is lost.*

1. When a desired object is visible in the eyepiece, keep pressing MODE until the "Select Item: Object" menu is displayed. Press ENTER to select this menu.
2. Scroll through the Object menu options until the "Object: Identify" screen appears.
3. Press ENTER. Autostar searches the database for the identity of the object being observed.
4. If the telescope is not directly on an Autostar database object, the nearest database object is located and displayed on the screen. Press GO TO and the telescope slews to that object.

Event Menu

The Event menu provides access to dates and times of astronomical events. The Event database includes:

Sunrise and **Sunset** calculates the time that the Sun rises or sets on the current date. Find rise and set times for other dates by entering a new date into the "Setup: Date" menu. See **DATE**, page 27.

Moonrise and **Moonset** calculates the time that the Moon rises or sets on the current date. Find rise and set times for other dates by entering a new date into the "Setup: Date" menu. See **DATE**, page 27.

Moon Phases displays the date and time of the next Full, New, 1st Quarter, and 3rd Quarter Moon.

Meteor Showers provides information on upcoming meteor showers, such as the Perseids, the Leonids, *etc.* Also lists the dates of the showers and when they reach maximum.

***NOTE:** Meteor showers cover large areas of the sky and are usually best observed with the naked eye.*

Solar Eclipse lists upcoming Solar Eclipses, including the date and type (total, annular, or partial) of eclipse, and the location and time of the first and last contacts of the Moon's shadow. Use the Scroll Up and Down keys to display the available data. Remember, never use a telescope to look at the Sun! See "WARNING!" to the left.

Lunar Eclipse lists upcoming Lunar Eclipses, including the date and type (total, partial, penumbral) of eclipse. Use the Scroll Up and Down keys to display the available data.

Autumn and **Vernal Equinox** calculates the time and date of the fall or spring equinox of the current year.

Winter and **Summer Solstice** calculates the time and date of the winter or summer solstice of the current year.

Glossary Menu

The Glossary menu provides an alphabetical listing of definitions and descriptions for common astronomical terms and Autostar functions. Access directly through the Glossary menu or through hypertext words embedded in Autostar. A *hypertext word* is any word in [**brackets**], usually found when using the Autostar Help function or when reading a scrolling message such as a description of a planet or star. Press ENTER whenever a hypertext word is on screen and Autostar goes to the glossary entry for that word.

To access directly from the Glossary menu, use the Scroll keys to scroll through the alphabet. Press ENTER on the desired letter. Scroll to the desired entry and then press ENTER to read the description.

Utilities Menu

The Utilities menu provides access to several extra features within Autostar, including a countdown timer and an alarm. The Utilities functions include:



TIPS FOR BEGINNERS



- Try to pick an observing site away from street and house lights and car headlights. While this is not always possible, the darker the site, the better.
- Give your eyes about ten minutes to adjust to the darkness before observing. Give your eyes a rest from observing every ten or fifteen minutes to relieve eyestrain.
- Try not to use a standard flashlight. A lot of observers use red LED flashlights or tape red cellophane over their flashlights to use for setup and map reading so they don't have to continually readjust their eyes to the darkness. Be careful not to shine bright lights if there are other observers in the area. Do not shine a flashlight into the telescope while someone is observing!
- Dress warmly. It gets chilly when you're sitting for prolonged periods.
- Practice setting up your equipment during the day or in a lighted area to become familiar with it before going to a dark site.
- Use your 25mm eyepiece to view terrestrial objects and wider areas of space, such as open star clusters. Use your 9mm eyepiece when you wish to view something up close, such as craters on the Moon or the rings of Saturn.
- Know your observing site. If you're going to try out an unfamiliar site, check it out in the daylight for possible obstructions and pitfalls.

Timer selects a countdown timer. This feature is useful for functions such as astrophotography and tracking satellites. See **OBSERVING SATELLITES**, page 30. To use the Timer, press ENTER, then choose "Set" or "Start/Stop."

- **Set:** Enter the time to be counted down, in hours, minutes, and seconds, then press ENTER.
- **Start/Stop:** Activates the timer set previously. Use the Scroll keys to toggle between ON and OFF. When ON is displayed, press ENTER to activate the timer. When the timer runs out, four beeps sound and the timer is deactivated.

Alarm selects a time for an alarm signal as a reminder. To use the Alarm, press ENTER, then choose "Set" or "Start/Stop."

- **Set:** Enter the time of day for the alarm to sound, in hours, minutes, and seconds, then press ENTER.
- **Start/Stop:** Activates the alarm set previously. Use the Scroll keys to toggle between ON and OFF. When ON is displayed, press ENTER to activate the alarm. When the alarm time arrives, Autostar beeps. Press ENTER to deactivate the alarm.

Eyepiece Calc calculates information about an eyepiece for the specific telescope to which Autostar is connected.

- **Field of View:** Scroll through a list of available eyepieces. When an eyepiece is selected, the field of view is calculated.
- **Magnification:** Scroll through a list of available eyepieces. When an eyepiece is selected, the magnification is calculated.
- **Suggest:** Autostar calculates and suggests the best eyepiece for viewing, based on the telescope and the object being viewed.

Display Options enables or disables Autostar's two initial displays. If both displays are disabled, Autostar begins with the Date display.

- **Sun Warning:** Turns the "Sun Warning" message on or off.
- **Getting Started:** Turns the "Getting Started" message on or off.

Brightness Adj: Adjusts the brightness of the display using the Scroll keys. When complete, press ENTER.

Contrast Adj: Adjusts the contrast of the display using the Scroll keys. When complete, press ENTER.

***NOTE:** This feature is usually only required in very cold weather.*

Beep: Turns the beep on or off.

Sleep Scope is a power saving option that shuts down Autostar and the telescope without forgetting its alignment. With "Sleep Scope" selected, press ENTER to activate the Sleep function. Autostar goes dark, but the internal clock keeps running. Press any key, except ENTER, to reactivate Autostar and the telescope.

Park Scope is designed for a telescope that is not moved between observing sessions. Align the telescope one time, then use this function to park the telescope. Next time it is powered up, enter the correct date and time – no alignment is required. Pressing ENTER causes the telescope to move to its pre-determined Park position. Once parked, the screen prompts to turn off power.

***IMPORTANT NOTE:** When the "Park Scope" option is chosen and the display prompts you to turn off the telescope's power, Autostar is unable to be returned to operation without turning the power off and then back on.*

Cord Wrap, when set to "On," moves the telescope in such a way as to prevent the cords and cables attached to your telescope assembly from getting wound around the assembly and tangled as the telescope slews to objects. "Off" is the default setting.

Setup Menu

The Setup menu's primary function is to align the telescope (see **EASY ALIGN**, page 19). However, there are numerous other features available within the Setup menu, including:

Date changes the date used by Autostar. This function is useful to check events in the past or future. For example, set the Date menu for a day three months in the future. Then check the "Select Item: Event" menu for the Sunset time on that date. See **EVENT MENU**, page 25.

Time changes the time entered into Autostar. Setting the correct time is critical for Autostar to properly calculate locations and events. Time may be set to 24-hour mode (military time) by selecting the "blank" option which follows the "AM" and "PM" options.

Daylight Saving is used to enable or disable Daylight Savings time.

***NOTE:** Daylight Savings Time may be referred to by different names in various areas of the world. Check local time to verify.*

Telescope accesses the several options, including:

- **Model:** Allows you to select the telescope model connected to Autostar.
- **Focal Length:** Displays the focal length of the selected telescope.
- **Az Ratio and Alt Ratio:** The Az (Azimuth) ratio and Alt (Altitude) ratio refers to the gears of the telescope's motors. Do not alter these numbers.
- **Az Percent:** The Az (Azimuth) Percent allows you to change the azimuth backlash, *i.e.*, the way the Arrow keys move the telescope along the azimuth (horizontal) axis. If you enter a value near 100, the telescope tube responds more quickly (it responds immediately at 100%) as you hold down an Arrow key and also slews (moves) the tube more quickly. If you enter a value near 0, it takes longer for the tube to respond as you hold down an Arrow key and also slews the tube more slowly. Experiment with this option. Try changing the percent value until you get a "feel" for the Arrow keys that is comfortable for you.

Alt Percent: The Alt (Altitude) Percent operates identical to the AZ Percent option (see above), but allows you to change the altitude backlash, *i.e.*, the way the Arrow keys move the telescope when moving along the altitude (vertical) axis.

- **Train Drive:** Trains the Altitude and Azimuth motors to locate objects with more precision.

If you are experiencing any problems with pointing accuracy, follow the procedure described in **APPENDIX C: TRAINING THE DRIVE**, page 40, to insure accurate pointing and tracking.

- **Tracking Rate:** Changes the speed at which the telescope tracks targets in the sky.
 - a. **Sidereal:** The default setting for Autostar; sidereal rate is the standard rate at which stars move from East to West across the sky due to the rotation of the Earth.
 - b. **Lunar:** Choose this option to properly track the Moon over long observing sessions.
 - c. **Custom:** Allows entry of user-defined tracking rates.
- **Reverse L/R:** Reverses the functions of the Left and Right Arrow keys (*i.e.*, the Right key moves the telescope to the left).
- **Reverse UP/DOWN:** Reverses the functions of the Up and Down Arrow keys (*i.e.*, the Up key moves the telescope down).

 **TIPS FOR BEGINNERS** 

Surf the Web

One of the most exciting resources for astronomy is the internet. The internet is full of websites with new images, discoveries, and the latest astronomical information. For example, when comet Hale-Bopp made its approach to our Sun in 1998, astronomers around the world posted new photos daily.

You can find websites for almost any topic relating to astronomy on the internet. Try the following key word searches: NASA, Hubble, HST, astronomy, Messier, satellite, nebula, black hole, variable stars, etc.

Check out Meade's website for the latest product and technical information. You can download the latest software revisions, links to other astronomical sites, coordinates of celestial objects and the latest satellite tracking information for your #494 AutoStar handbox. See page 30 for more information. You'll find our website at:

<http://www.meade.com/>

Here are some other sites you might find interesting:

- *Sky & Telescope:*
<http://www.skypub.com/>
- *Astronomy:*
<http://www2.astronomy.com/astro/>
- *The Starfield:*
<http://users.nac.net/gburke/>
- *Astronomy Picture of the Day:*
<http://antwrp.gsfc.nasa.gov/apod/>
- *Heaven's Above (satellite observing information):*
<http://www.heavens-above.com/>

- **Quiet Slew:** Sets the maximum slew rate to 1.5° for quieter operation.
- **Max Elevation:** Allows you to enter a value in degrees that sets a limit as to how far the optical tube can swing upward during a programmed slew. (Note that it does not prevent you from performing a manual slew past this limit.) This is useful when you have a camera or other peripheral attached to the telescope—you can prevent it from striking the telescope base.
- **Min AOS (Acquisition of Signal):** Allows you enter a value in degrees. This value represents the altitude at which your telescope begins to slew when acquiring a satellite track. This is useful when you are observing satellites, but a tall tree or building is obstructing the telescope. For example, you might begin to track the satellite at 15° altitude, instead of 5°. See **OBSERVING SATELLITES**, page 30, for more information about satellites.
- **Calibrate Motor:** If the telescope motors appear to have a problem, use this option to retest the motors before performing a Reset. This option is also used if an Autostar unit is moved between telescopes, to match Autostar to the new telescope. To calibrate the motors, select this option and press ENTER.
- **High Precision:** If High Precision is turned on, when looking for a faint celestial object (*i.e.*, a nebula or galaxy), Autostar first slews to a nearby bright star and displays "ENTER to Sync." Center the star in the eyepiece, then press ENTER. At that point the telescope has a high precision alignment to that part of the sky and it then slews to the object that was originally requested.

Targets switches between Astronomical targets and Terrestrial targets. If "Astronomical" is selected, the telescope tracking motor is activated and any object you observe will remain centered in the eyepiece. If "Terrestrial" is selected, the tracking motor is turned off. To learn how to track an object automatically, see page 17.

Site provides access to several options including:

- **Select:** Displays the currently selected observing site. Use the Scroll keys to cycle through all available sites (see **ADD** below). Press ENTER when the site you wish to select displays. Use this option when you move to a different geographic location.
- **Add:** Allows you to add new observing sites to the database (up to six sites may be stored). Scroll through the list of Countries/States. Press ENTER when the site you wish to add displays. Then choose the desired city in the same manner.
- **Delete:** Deletes a stored site from the database.
- **Edit:** Edits a selected site, including: the name, latitude, longitude, and time zone. Time Zone refers to the Greenwich Mean Time (GMT) time zone shift. Users West of Greenwich, England use "-" hours, East of Greenwich use "+" hours. For the United States, look up the time zone shift in **Table 1**.

NOTE: Autostar compensates for daylight savings time, if selected. See **SETUP MENU: DAYLIGHT SAVING**, page 27.

- **Address:** Use the Up and Down Arrow keys to enter your street address, city, state, and zip code. Press ENTER when the entry is complete.

Download transfers information from a personal computer or another Autostar. During the operation, the warning "Downloading Do Not Turn Off" appears.

NOTE: The Download function requires the optional #506 Astrofinder Software and Cable Connector Kit. See the instruction sheet included with the kit for more information on how to download. Also see **OPTIONAL ACCESSORIES**, page 33.

Statistics provides basic statistical data about Autostar, including:

- **Characters Free:** Shows how much room is available in user-defined object memory.
- **Version:** Shows the current version of the Autostar software.

Reset completely resets Autostar. Most values entered into the menus revert to factory defaults. Autostar requires initialization again after a Reset before proceeding with observations. See **INITIALIZING AUTOSTAR**, page 17.

IMPORTANT NOTE:

While performing the automatic tracking procedure, only use the Arrow keys to move the telescope. Once the telescope has been set in the Alt/Az home position, do not loosen the telescope locks (13 and 14, Fig. 1), or move the base manually, or alignment will be lost.

Time Zone	Shift
Atlantic	-4 Hours
Eastern	-5 Hours
Central	-6 Hours
Mountain	-7 Hours
Pacific	-8 Hours
Hawaii	-10 Hours

Table 1: Time Zone Shift.

NOTE:

The Download function requires the optional #506 Astrofinder Software and Cable Connector Kit. See the instruction sheet included with the kit for more information on how to download. Also see **OPTIONAL ACCESSORIES**, page 33.

ADVANCED FEATURES

Terrestrial Observing

The ETX-80AT-BB makes an excellent high-resolution, terrestrial (land) telescope. Viewing terrestrial objects requires looking along the Earth's surface through heat waves. These heat waves often cause degradation of image quality. Low power eyepieces, like the MA 25mm eyepiece, magnify these heat waves less than higher power eyepieces. Therefore, low power eyepieces provide a steadier, higher quality image. If the image is fuzzy or ill-defined, reduce to a lower power eyepiece, where the heat waves do not have such an effect on image quality. Observing in early morning hours, before the ground has built up internal heat, produces better viewing conditions than during late afternoon hours.

Astronomical Observing

Used as an astronomical instrument, your telescope has many optical and electromechanical capabilities. It is in astronomical applications where the high level of optical performance is readily visible. The range of observable astronomical objects is, with minor qualification, limited only by the observer's motivation.

Sidereal Rate

As the Earth rotates beneath the night sky, the stars appear to move from East to West. The speed at which the stars move is called the sidereal rate.

If the telescope is aligned, the motor drive is designed to rotate the telescope at the sidereal rate so that it automatically tracks the stars. This tracking makes it easy to locate objects and keep them centered in the telescope's eyepiece.

Alignment (Mount)

The telescope's mount permits the movement of the telescope in both Altitude (vertically) and Azimuth (horizontally). In order to automatically track a celestial object, the mount must be properly aligned. Easy Alignment is described on page 19.

Alt/Az Alignment

One-Star Alt/AZ Alignment or Two-Star Alt/AZ Alignment allows you to choose the alignment stars during the alignment procedure. The stars are chosen from AutoStar's database of alignment stars. The database displays after One-Star Alt/Az or Two-Star Alt/Az Alignment is selected. .

The term "Alt/Az." is frequently used to refer to the Altitude or horizontal and Azimuth or vertical movements of the ETX-80AT-BB telescope. Other terms to describe a telescope's movement may be used with telescopes that have mounts different from the ETX-80AT-BB.

Alt/Az Home Position

To set your telescope in the "Alt/Az" home position (also see **Fig. 20**, page 19):.

- Loosen the telescope's vertical lock (**13**, **Fig. 1**).
- Level the optical tube with the horizon. Move the optical tube until the pointer points at "0" on the setting circle.
- Tighten the vertical lock to a "firm feel" only.
- Unlock the horizontal lock (**14**, **Fig. 1**) and turn the telescope horizontally until it points North. Re-lock the horizontal lock.
- Remove the 45° prism and eyepiece from the rear cell port. It may interfere with the alignment procedure. After alignment, you may replace the prism and eyepiece.
- Press ENTER.

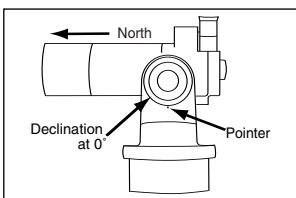

Fig. 25: Alt/Az Home Position.

Two-Star Alt/Az Alignment

Two-Star Alignment requires some knowledge of the night sky. AutoStar provides a database of bright stars and two stars from this database are chosen by the observer for alignment.

1. **Perform steps 1 through 8** as described in the **EASY ALIGNMENT PROCEDURE**, page 19.
2. **Align to the first star.** AutoStar then displays a database of stars for the observer to choose from. Use the Scroll keys to scroll to a star that you wish to align upon. Select a star that you can easily locate in the night sky.
3. **Press ENTER.** The telescope slews to the star for alignment. Use the Arrow keys to move the telescope until the star is visible and centered in the eyepiece.
4. **Press ENTER.** Repeat procedure for the second alignment star. The telescope is aligned and you are now ready to use AutoStar's GO TO capabilities for a night of observing.

One-Star Alt/Az Alignment

One-Star Alignment requires some knowledge of the night sky. AutoStar provides a database of bright stars. One-Star Alignment is identical to Two-Star Alt/Az: Alignment (see **TWO-STAR ALT/AZ ALIGNMENT**, above), except only one star from this database is chosen by the observer for alignment.

IMPORTANT NOTE: *The accuracy of One-Star Alt/Az Alignment, unlike the Two-Star Alt/Az Alignment procedure, depends on how well the observer levels the telescope and how close to North the telescope is pointed when setting the Home Position (Fig. 24). Because Two-Star Alignment uses two stars to align upon, it is more precise than One-Star Alignment.*

Observing a Satellite

NOTE: *Satellite observing is an exciting challenge. Most satellites are in low orbit, traveling at approximately 17,500 mph. They move quickly across the sky and are visible only for a few minutes, requiring AutoStar to slew the telescope rapidly. Best viewing is near Sunrise or Sunset when the sky is still dark. Viewing in the middle of the night can be problematic because the satellite may pass overhead, but not be visible as it is in the Earth's shadow.*

1. Choose a satellite from the Select menu, then press ENTER. AutoStar scans its database to find if that satellite is expected to pass overhead within the next 6 hours.
2. If a satellite is expected, use the Scroll keys to access a list of information about the pass, including acquisition time, location, etc.
3. At the end of the list is "Alarm." Press ENTER and AutoStar automatically sets the alarm to sound several minutes before the scheduled appearance. You may return to regular observations until the alarm goes off.
4. When the alarm goes off, return to the Satellite menu and press a Scroll key until the desired satellite is on the top line of the display.
5. Press GO TO. AutoStar slews the telescope to where the satellite should appear. The motor drive stops and a countdown starts.

NOTE: *If the scheduled appearance position of the satellite is obstructed (i.e., by a building, tree, or hill), press ENTER and AutoStar starts to move the telescope along the expected satellite track. When the track clears the obstruction, press ENTER again to pause the telescope, then continue with this procedure.*
6. With about 20 seconds left on the countdown timer, start watching through the eyepiece for the satellite to enter the field of view.
7. When the satellite enters the field of view, press ENTER. The telescope starts to track with the satellite.

8. Use the Arrow keys to center the object in the eyepiece to view the object. Satellite orbits change and new satellites (including the Space Shuttle) are launched. Visit the Meade website (www.meade.com) approximately once a month to get updated information and instructions on how to download this data to AutoStar. If orbital parameters are more than one month old, the satellite pass may not happen at the time predicted by AutoStar. To download new satellite data into AutoStar memory requires the optional Astrofinder Software and Cable Connector Kit. See **OPTIONAL ACCESSORIES**, page 33.

Digital Photography with the ETX

Although digital cameras still cannot match the quality of images provided by traditional 35mm cameras, they provide some significant advantages to the casual astrophotographer: You do not have to develop the images (instant images), lower costs, computer and internet readiness. And because unwanted photos are easily discarded, they provide the freedom to experiment.

Digital cameras present some problems for the astrophotographer: Many models have lenses that cannot be removed, present difficulties in attaching to a telescope, often lack manual focusing and allow limited exposure times. Long exposures with digital cameras introduce undesirable noise and artifacts into a digital image. This limits the range of astro images to the Moon, planets and bright stars.

SLR digital cameras usually work the best for astrophotography, although they are still a bit pricey.

Some tips for better photos:

- If you cannot remove the lens to your camera, look for a commercially available digital t-adapter. New solutions for attaching a digital camera to a telescope are becoming available as time goes by.
- If the camera is not directly coupled to the eyepiece, keep it as close to the eyepiece as possible and center the image to be photographed to minimize vignetting (darkening of the edges of the photo).
- Try to block ambient light (from street lights, house, etc.) from the eyepiece and the camera with a piece of cardboard, a screen, etc.
- Keep extra (charged) batteries on hand for your camera as digital cameras often drain batteries in a short period of time. Rechargeable Lithium batteries provide power for a longer period than non-rechargeable batteries. If practical, use an AC adapter.
- If using manual focus, set to infinity. Otherwise, using the camera's autofocus is OK.
- Experiment with your camera's exposure, brightness and /or contrast settings. Keep notes for future reference.
- Many digital cameras have a manual ISO setting. Short exposures times work the best.
- Use your camera's highest image quality and lowest compression settings. Although this fills up your camera's memory more quickly, it produces the best quality photos.
- Use the camera's timer or remote shutter release (if available for your camera) to minimize vibration. Wireless shutter releases may be available for some model digital cameras. If you do not have a shutter release, use the camera's timer (sometimes called "self-timer"), which is available with most digital cameras. The timer also minimizes vibration.

Photography with Meade's AutoStar Suite™

The AutoStar Suite with Meade LPI™ (Lunar Planetary Imager) or Meade Deep Sky Imager™ turns your Meade ETX telescope, AutoStar and PC into even more powerful and easy-to-use astronomical 5. Press GO TO. AutoStar slews the telescope to where the satellite should appear. The motor drive stops and a countdown starts.

NOTE: *If the scheduled appearance position of the satellite is obstructed (i.e., by a building, tree, or hill), press ENTER and AutoStar starts to move the telescope along the expected satellite track. When the track clears the obstruction, press ENTER again to pause the telescope, then continue with this procedure.*

6. With about 20 seconds left on the countdown timer, start watching through the eyepiece for the satellite to enter the field of view.
7. When the satellite enters the field of view, press ENTER. The telescope starts to track with the satellite. instrument.

LPI (**Fig. 26**) and Deep Sky Imager (**Fig. 27**) combine the power of an electronic astronomical imager with the simplicity of a web cam. Check out the following imager features:

- LPI: Achieve great results the first time out on the Moon, planets, brighter deep-sky objects and terrestrial targets.
- Deep Sky Imager: Capture dim and faint objects that are often invisible to the eye, that once could only be captured by large observatories or expensive CCD equipment. For example, the Horsehead and Reflection nebulas in Orion.
- Easy to use with real-time display of object on your PC screen. Just center, focus and shoot.
- Magic Eye software-assisted focusing.
- Automatic and manual exposure control from .001 to 15 seconds (up to 450x longer than web cams).
- Automatically takes multiple exposures.

The AutoStar Suite Software includes powerful tools to help you get the most from your Meade ETX telescope:

- Sophisticated planetarium program with over 19 million objects.
- Select objects from the planetarium display and the telescope slews to those objects.
- Create time-lapse movies of objects, such as Jupiter
- Create your own Guided Tours.
- Advanced Image Processing Software including Unsharp Masking, Convolution Filtering and many other features.
- Control all AutoStar functions from your PC.
- Talking Telescope software translates AutoStar text to synthesized speech through PC speaker.
- Includes a cable to connect your ETX model to your PC.



Fig. 26: *The Lunar Planetary Imager.*



Fig. 27: *The Deep Sky Imager.*

OPTIONAL ACCESSORIES

A wide assortment of professional Meade accessories are available for the ETX-80AT-BB. Meade accessories greatly extend many important applications to the telescope, from low-power, wide-field terrestrial viewing to high-power lunar and planetary observing. The premium quality of these accessories is well-suited to the quality of the instrument itself.

Meade telescopes and accessories, including optional accessories for ETX telescopes, are available at more than 3,000 dealer locations in the U.S. and Canada and through Meade international distributors worldwide. Once you have identified the accessories you wish to order, contact your local Meade authorized dealer. To find a dealer near you call **(800) 626-3233** or visit the Meade website at **www.meade.com**.

#506 AstroFinder™ Software and Cable Connector Kit: Displays more than 10,000 celestial wonders – galaxies, nebulae, star clusters, stars, and planets – on your PC, enabling even the beginner to locate and identify objects to observe with the telescope or to print out star charts for use in observing sessions. Operates with any Windows™-based personal computer. The Cable Connector Kit permits connection of the ETX-80AT-BB, AutoStar, and PC, for downloading of new software to AutoStar or for updating of Earth satellite or other celestial object positions. This kit is included with each AstroFinder Software package.

Eyepieces (1.25" barrel diameter): For higher or lower magnifications, Meade 4-element Series 4000 eyepieces yield wider fields of view with excellent edge-of-field corrections and are available in a large range of focal lengths.



Fig. 28: Meade Series 4000 Super Plossl Eyepieces.

#126 2x Barlow Lens (1.25"): For telescopes that accommodate 1.25" eyepieces, the Barlow lens doubles each eyepiece power while maintaining excellent image corrections.

#3200 Lunar & Planetary Color Filter Set: Meade optical glass color filters increase image contrast and resolution of the Moon and planets. The #3200 Set includes light yellow, very light red, very light blue, and neutral density filters. Each filter threads into the barrels of all Meade MA, PL, and WA eyepieces and is packed in a separate plastic case for secure storage.

#827 8 x 25mm Right-Angle Viewfinder and Bracket: For easy sighting of terrestrial or astronomical objects prior to their observation in the main telescope, the #827 8 x 25mm Right-Angle Viewfinder (**Fig. 30**) displays a wide 7.5° field of view. Includes a crosshair eyepiece and precise helicoid focusing; the included viewfinder bracket attaches to the main telescope in seconds.

64T-Adapter: The T-adapter allows you connect a 35mm camera to your ETX telescope. Obtain the T-mount that is correct for your individual brand of camera separately.

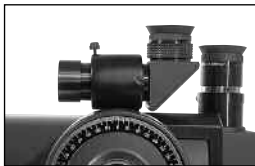

Fig 29: #827 Right-Angle Viewfinder.

MAINTENANCE AND SERVICING

General Maintenance

The ETX-80AT-BB telescope is a precision optical instrument designed to yield a lifetime of rewarding applications. Given the care and respect due any precision instrument, your telescope will rarely require factory servicing or maintenance. Maintenance guidelines include:

1. Avoid cleaning the telescope's optics. A little dust on the front surface of the telescope's correcting lens causes virtually no degradation of image quality and should not be considered reason to clean the lens.
2. When absolutely necessary, dust on the front lens should be removed with gentle strokes of a camel hair brush or blown off with an ear syringe (available at any pharmacy). Do not use a commercial photographic lens cleaner.
3. Organic materials (*e.g.*, fingerprints) on the front lens may be removed with a solution of 3 parts distilled water to 1 part isopropyl alcohol. A single drop of biodegradable dish-washing soap may be added per pint of solution. Use soft, white facial tissues and make short, gentle strokes. Change tissues often.

CAUTION: *Do not use scented, colored, or lotioned tissues as damage could result to the optics.*

4. If your telescope is used outdoors on a humid night, telescope surfaces may accumulate water condensation. While such condensation does not normally cause any damage to the telescope, it is recommended that the entire telescope be wiped down with a dry cloth before being packed away. Do not, however, wipe any of the optical surfaces. Rather, simply allow the telescope to sit for some time in warm indoor air, so that the wet optical surfaces can dry unattended. In addition, the dust cap should not be placed back on to the optical tube until the telescope is thoroughly dry.
5. If your telescope is not to be used for an extended period, perhaps for one month or more, it is advisable to remove the six AA-size batteries from inside the drive base. Batteries left installed for prolonged periods may leak, causing damage to the telescope's electronic circuitry. See **TELESCOPE ASSEMBLY**, page 13.
6. Do not leave your telescope outdoors on a warm day or inside a sealed car for an extended period of time. Excessive ambient temperatures can damage the telescope's internal lubrication and electronic circuitry.
7. A (English-format) hex wrench is provided with the ETX-80AT-BB. Use the wrench to tighten the set-screws of any knobs which may loosen, such as the horizontal lock knob or focus knob.

Storage and Transport

When not in use, store the telescope in a cool, dry place. Do not expose the instrument to excessive heat or moisture. It is best to store the telescope in its original box with the vertical and horizontal locks (13 and 14, Fig. 1) in the unlocked positions. If shipping the telescope, use the original box and packing material to protect the telescope during shipment.

When transporting the telescope, take care not to bump or drop the instrument; this type of abuse can damage the optical tube and/or the objective lens. It is highly recommended to use the optional Hard Case to transport the telescope. See **OPTIONAL ACCESSORIES**, page 33.

Inspecting the Optics

A Note About the "Flashlight Test": If a flashlight or other high-intensity light source is pointed down the main telescope tube, the view (depending upon the observer's line of sight and the angle of the light) may reveal what appears to be scratches, dark or bright spots, or uneven coatings, giving the appearance of poor quality optics. These effects are only seen when a high intensity light is transmitted through the lens or reflected off the mirror, and can be seen on any high quality optical system, including giant research telescopes.

The optical quality of a telescope cannot be judged by the "flashlight test"; the true test of optical quality can only be conducted through careful star testing.

Troubleshooting

The following suggestions may be helpful with operation of the ETX-80AT-BB.

The power indicator light on the telescope does not come on or there is no response when pressing AutoStar Arrow keys:

- Verify that the Computer Control Panel power switch (**10c, Fig. 1**) is in the ON position.
- Verify that the AutoStar cord (**8, Fig. 5**) is firmly connected to the HBX port (**10a, Fig. 1**).
- Verify that the batteries are installed correctly and that they have sufficient charge. See **TELESCOPE ASSEMBLY**, page 13.

Note: *If the batteries are getting low on charge, there will be a marked difference in the slew speed. The speed indicator lights may also flash and the speed may change. If any of these symptoms occur, turn the power off and replace the batteries.*

- If AutoStar does not respond to commands, set the Computer Control Panel power switch to OFF and then back to ON.
- If the telescope does not slew after power is applied or if the motor quits or stalls, verify that there are no physical obstructions that would impede telescope movement.
- If all physical obstacles are removed and the telescope still does not move properly, turn off the power and unplug AutoStar. Plug the AutoStar back in and turn the power back on.

Cannot seem to focus (No image appears in the eyepiece):

- Keep turning the focus knob. Your ETX telescope has a fine focusing mechanism which allows you to focus an image very precisely. However, this means that you may have to rotate the focus knob 20 to 40 complete turns to achieve focus, particularly the first time you use your telescope. After that, fewer turns will be needed.

Still unable to see an image through the eyepiece:

- Confirm that the dust cap has been removed from the telescope.
- Confirm that the flip-mirror control (**20, Fig. 1**) is in the "up" position (**Fig. 4a**) if using the eyepiece holder (**3, Fig. 1**) so that light is directed to the eyepiece (**1, Fig. 1**). Confirm that the flip-mirror control is in the "down" position (**Fig. 4b**) if using the #933 Erecting Prism.

Slew speed does not change when the Speed/? key is pressed, or the telescope moves slowly even though the fast slew speed is chosen:

- The battery power may be low. See **TELESCOPE ASSEMBLY**, page 13.

Images through the eyepiece appear unfocused or distorted:

- The magnification used may be too high for the seeing conditions. Back off to a lower power eyepiece. See **TOO MUCH POWER?**, page 18.
- If inside a warm house or building, move outside. Interior air conditions may distort terrestrial or celestial images, making it difficult, if not impossible, to obtain a sharp focus. For optimal viewing, use the telescope outside in the open air instead of observing through an open or closed window or screen.
- If viewing a land object on a warm day, heat waves distort the image.
- The optics within the telescope need time to adjust to the outside ambient temperature to provide the sharpest image. To "cool down" the optics, set the telescope outside for 10 to 15 minutes before observing begins.

Telescope moves off a terrestrial object while observing:

- Verify that the vertical and horizontal locks have been tightened to a "firm feel" (**13 and 14, Fig. 1**).

Telescope pauses when changing slew direction:

- This pause is normal.

A terrestrial object appears reversed left-for-right:

- An eyepiece in the standard 90° observing position (**5, Fig. 1**) yields this image orientation. To view a correctly oriented image, the Erecting Prism (**3, Fig. 1**) is required.

Meade Customer Service

If you have a question concerning your ETX-80AT-BB, contact the Meade Instruments Customer Service Department at:

Telephone: (800) 626-3233

Customer Service hours are 8:00 AM to 5:00 PM, Pacific Time, Monday through Friday. In the unlikely event that the ETX requires factory servicing or repairs, write or call the Meade Customer Service Department first, before returning the telescope to the factory, giving full particulars as to the nature of the problem, as well as your name, address, and daytime telephone number. The great majority of servicing issues can be resolved by telephone, avoiding return of the telescope to the factory.

ETX-80AT-BB Specifications

Optical design	Achromatic Refractor
Clear aperture	80mm (2.76")
Focal length	400mm
Focal ratio (photographic speed).....	f/4.4
Near focus (approx.)	17 ft. (5.2m)
Resolving power	1.6 arc secs
Multi-coatings on objective lens	Standard
Limiting visual stellar magnitude (approx.)	11.5
Image scale	4.1°/inch
Maximum practical visual power	240X
Optical tube dimensions	
(dia. x length)	9.3cm x 30.4-37.1cm (3.6" x 12-14.6")
Eyepieces	
2x Flip Barlow	Built in
Telescope mounting.....	Fork type; double tine
Setting circle diameters	Dec: 3.5"; RA: 7"
Input voltage	9-volts DC
Motor Drive System	DC servo motors with encoders, both axes
Slow-Motion Controls	Electric, 9 speed, both axes
Hemispheres of operation	North and South, switchable
Bearings:	
Altitude	Acetal
Azimuth	Nylon
Materials	
Tube body	ABS
Mounting	High-impact ABS
Objective lens (crown, flint)	BK7, F2
Telescope dimensions	40.4cm x 18cm x 22cm (15.9" x 7" x 9")
Prism	45° roof
Tripod.....	Photo style
Battery Life (approx.)	
with AutoStar	20 hrs.
Compass/Bubble Level included	

AutoStar Specifications

Processor	68HC11, 8MHz
Flash Memory512KB, reloadable
Keypad	10 key alphanumeric
Display	2 line, 16 character LCD
Backlight	Red LED
Coil Cord24"

AutoStar Dimensions

Length	14.2cm (5.60")
Width (LCD end)	78.0cm (3.08")
Width (Connector end)	53.5cm (2.10")
Depth	23.5cm (0.93")
AutoStar net weight	0.169kg (0.35 lbs.)

APPENDIX A: USING AUTOSTAR TO ENTER R.A. AND DEC COORDINATES

Although AutoStar's database contains more than 1400 objects (stars, nebulae, planets, etc.) that you can observe, you may eventually want to view objects that are not part of the database. AutoStar provides a feature that allows you to enter an object's R.A. and Dec coordinates in the "User: Objects" option of AutoStar's Object menu and then automatically slews the telescope to the user-entered coordinates.

In order to use this menu option, you first need to look up the R.A. and Dec coordinates of the object or objects you wish to observe. Check out your local library, computer store or bookstore for astronomy books, CD Roms, or magazines (such as *Sky & Telescope* or *Astronomy*), to find coordinates of celestial objects.

The objects/coordinates you enter become part of your own permanent database, called "User Objects." You may use this menu to view these object as often as you like, but the objects' coordinates just need to be entered once.

To enter coordinates of an object into the "User: Objects" option of the Object menu:

1. Make sure AutoStar has been initialized (see **INITIALIZING AUTOSTAR**, page 17) and the telescope has been aligned and set to the Alt/Az home alignment position (see **EASY ALIGNMENT**, page 19).
2. After the telescope is aligned, "Select Item: Object" displays. (If necessary, use the Scroll keys to scroll through the menus, as previously described, to find this option.) Press ENTER.
3. "Object: Solar System" displays. Keep pressing the Scroll Up key until "Object: User Object" displays and press ENTER.
4. "User Object: Select" displays. Press the Scroll Down key once. "User Object: Add" displays. Press ENTER.
5. "Name" displays on the top line and a blinking cursor on the second line. Use the Arrow keys (as previously described) to enter the name of the object you wish to add to the database. When you are finished, press ENTER.
6. "Right Asc.: +00.00.0" displays. Use the Arrow keys to enter the digits for the Right Ascension coordinate of your object. If necessary, use the Scroll Keys to change "+" to "-." When you are finished, press ENTER.
7. "Declination: +00°.00'" displays. Use the Arrow keys to enter the digits for the Declination coordinate of your object. If necessary, use the Scroll Keys to change "+" to "-." When you are finished, press ENTER.
8. AutoStar then prompts you to enter the Size of the object. This step is optional. Use the Arrow keys to enter this information, if so desired, and press ENTER to go to the next display. If you do not wish to enter this information, simply press ENTER.
9. AutoStar then prompts you to enter the Magnitude of the object. This step is also optional. Use the Arrow keys to enter this information, if so desired, and press ENTER to go to the next display. "User Object: Add" displays again.

To GO TO a user-entered object:

1. With "User Object: Add" displayed, press the Scroll Up key once. "User Object: Select" displays. Press ENTER.
2. Use the Scroll keys (if necessary) to scroll to the desired object. Press ENTER.
3. The name of the object and the Right Ascension and Declination coordinates display.
4. Press GO TO and the telescope slews to the object.

APPENDIX B: HELPFUL CHARTS

Latitude Chart for Major Cities of the World

Latitudes of major cities around the world are listed below. To determine the latitude of an observing site not listed on the chart, locate the city closest to your site. Then follow the procedure below:

Northern Hemisphere observers (N): If the site is over 70 miles (110 km) North of the listed city, add one degree for every 70 miles. If the site is over 70 miles South of the listed city, subtract one degree per 70 miles.

Southern Hemisphere observers (S): If the site is over 70 miles North of the listed city, subtract one degree for every 70 miles. If the site is over 70 miles South of the listed city, add one degree per 70 miles.

UNITED STATES			SOUTH AMERICA		
City	State	Latitude	City	Country	Latitude
Albuquerque	New Mexico	35° N	Asuncion	Paraguay	25° S
Anchorage	Alaska	61° N	Brasilia	Brazil	24° S
Atlanta	Georgia	34° N	Buenos Aires	Argentina	35° S
Boston	Massachusetts	42° N	Montevideo	Uruguay	35° S
Chicago	Illinois	42° N	Santiago	Chile	34° S
Cleveland	Ohio	41° N	<hr/>		
Dallas	Texas	33° N	ASIA		
Denver	Colorado	40° N	City	Country	Latitude
Detroit	Michigan	42° N	Beijing	China	40° N
Honolulu	Hawaii	21° N	Seoul	South Korea	37° N
Jackson	Mississippi	32° N	Taipei	Taiwan	25° N
Kansas City	Missouri	39° N	Tokyo	Japan	36° N
Las Vegas	Nevada	36° N	Victoria	Hong Kong	23° N
Little Rock	Arkansas	35° N	<hr/>		
Los Angeles	California	34° N	AFRICA		
Miami	Florida	26° N	City	Country	Latitude
Milwaukee	Wisconsin	46° N	Cairo	Egypt	30° N
Nashville	Tennessee	36° N	Cape Town	South Africa	34° S
New Orleans	Louisiana	30° N	Rabat	Morocco	34° N
New York	New York	41° N	Tunis	Tunisia	37° N
Oklahoma City	Oklahoma	35° N	Windhoek	Namibia	23° S
Philadelphia	Pennsylvania	40° N	<hr/>		
Phoenix	Arizona	33° N	AUSTRALIA		
Portland	Oregon	46° N	City	State	Latitude
Richmond	Virginia	37° N	Adelaide	South Australia	35° S
Salt Lake City	Utah	41° N	Brisbane	Queensland	27° S
San Antonio	Texas	29° N	Canberra	New South Wales	35° S
San Diego	California	33° N	Alice Springs	Northern Territory	24° S
San Francisco	California	38° N	Hobart	Tasmania	43° S
Seattle	Washington	47° N	Perth	Western Australia	32° S
Washington	District of Columbia	39° N	Sydney	New South Wales	34° S
Wichita	Kansas	38° N	Melbourne	Victoria	38° S
<hr/>			<hr/>		
EUROPE					
City	Country	Latitude			
Amsterdam	Netherlands	52° N			
Athens	Greece	38° N			
Bern	Switzerland	47° N			
Copenhagen	Denmark	56° N			
Dublin	Ireland	53° N			
Frankfurt	Germany	50° N			
Glasgow	Scotland	56° N			
Helsinki	Finland	60° N			
Lisbon	Portugal	39° N			
London	England	51° N			
Madrid	Spain	40° N			
Oslo	Norway	60° N			
Paris	France	49° N			
Rome	Italy	42° N			
Stockholm	Sweden	59° N			
Vienna	Austria	48° N			
Warsaw	Poland	52° N			

APPENDIX C: TRAINING THE DRIVE

Train the telescope motors using AutoStar. Perform this procedure after RESET or if you are experiencing any pointing accuracy problems. Figure 30 depicts the complete Drive Training procedure.

Note: Use a terrestrial object, such as a telephone pole or lamp post, to train the drive. Complete this exercise once every 3 to 6 months to maintain the highest level of telescope pointing accuracy.

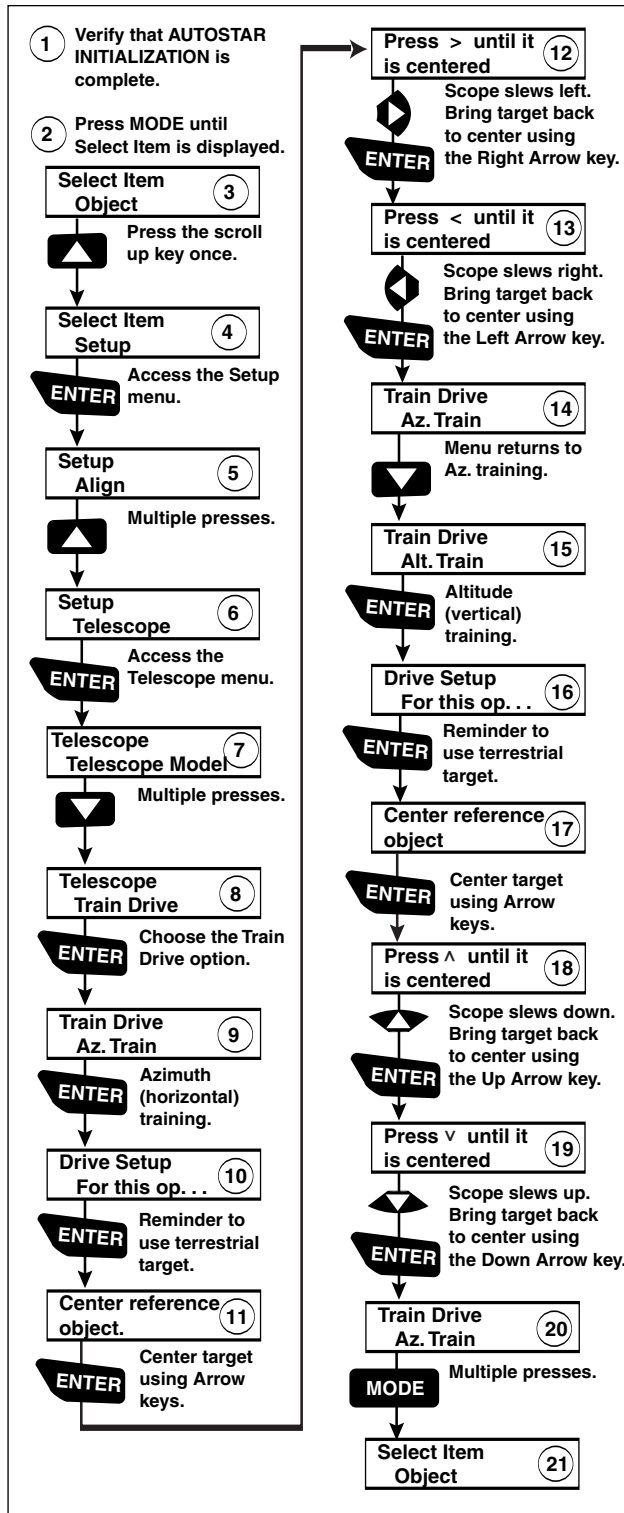

Figure 30: Training the Drive Procedure.

TIPS FOR BEGINNERS

Further Study...

This manual gives only the briefest introduction to astronomy. If you are interested in pursuing further studies in astronomy, a few topics are suggested below that are worth reading up on. Try looking up some of these topics in AutoStar's glossary.

Also included below is a small sampling of books, magazines, and organizations that you might find helpful.

Topics

1. How is a star born? How does a solar system form?
2. How is the distance to a star measured? What is a light year?
3. What is red shift and blue shift?
4. How are the craters on our Moon formed? How old is the Moon and Earth? How old is the Sun?
5. What is a black hole? A quasar? A neutron star?
6. What are stars made of? Why are stars different colors? What is a white dwarf? A red giant?
7. What is a nova? A supernova?
8. What are comets? Asteroids? Meteors? Meteor showers? Where do they come from?
9. What is a planetary nebula? A globular cluster?
10. What is the Big Bang? Is the universe expanding or contracting, or does it always remain the same?

Books

1. *The Guide to Amateur Astronomy* by Jack Newton and Philip Teece
2. *The Sky: A User's Guide* by David Levy
3. *Turn Left at Orion* by Guy Consolmagno & Dan Davis
4. *Astrophotography for the Amateur* by Michael Covington

Magazines

1. *Sky & Telescope*
Box 9111, Belmont, MA 02178
2. *Astronomy*
Box 1612, Waukesha, WI 53187

Organizations:

1. Astronomical League
Executive Secretary
5675 Real del Norte, Las Cruces, NM 88012
2. The Astronomical Society of the Pacific
390 Ashton Ave, San Francisco, CA 94112
3. The Planetary Society
65 North Catalina Ave, Pasadena, CA 91106

APPENDIX D: BASIC ASTRONOMY

In the early 17th century, Italian Scientist Galileo, using a crude telescope considerably smaller than the ETX-80AT-BB, turned it to look towards the sky instead of distant trees and mountains. What he saw, and what he realized about what he saw, forever changed the way mankind thought of the universe. Imagine what it must have been like being the first human to see moons revolve around the planet Jupiter or to see the changing phases of Venus! Because of his observations, Galileo correctly realized Earth's movement and position around the Sun, and in doing so, gave birth to modern astronomy. Yet Galileo's telescope was so crude, he could not clearly make out the rings of Saturn.

Galileo's discoveries laid the foundation for understanding the motion and nature of the planets, stars, and galaxies. Building on his foundation, Henrietta Leavitt determined how to measure the distance to stars; Edwin Hubble proposed a glimpse into the origin of the universe; Albert Einstein unraveled the relationship of time and light. Almost daily, using sophisticated successors to Galileo's crude telescope, such as the Hubble Space Telescope, more and more mysteries of the universe are being solved and understood. We are living in a golden age of astronomy.

Unlike other sciences, astronomy welcomes contributions from amateurs. Much of the knowledge we have on subjects such as comets, meteor showers, variable stars, the Moon, and our solar system comes from observations made by amateur astronomers. So as you look through your Meade ETX telescope, keep in mind Galileo. To him, a telescope was not a mere machine of glass and metal, but something far more - a window through which the beating heart of the universe might be glimpsed, a fuse to set fire to mind and imagination.

AutoStar Glossary

Be sure to make use of AutoStar's Glossary feature. The Glossary menu provides an alphabetical listing of definitions and descriptions of common astronomical terms. Access directly through the Glossary menu or through hypertext words embedded in AutoStar. See **GLOSSARY MENU**, page 25, for more information.

Objects in Space

Listed below are some of the many astronomical objects that can be seen with the ETX-80AT-BB:

The Moon

The Moon is, on average, a distance of 239,000 miles (380,000km) from Earth and is best observed during its crescent or half phase when Sunlight strikes the Moon's surface at an angle. It casts shadows and adds a sense of depth to the view (**Fig. 31**). No shadows are seen during a full Moon, causing the overly bright Moon to appear flat and rather uninteresting through the telescope. Be sure to use a neutral Moon filter when observing the Moon. Not only does it protect your eyes from the bright glare of the Moon, but it also helps enhance contrast, providing a more dramatic image.

Using the ETX-80AT-BB, brilliant detail can be observed on the Moon, including hundreds of lunar craters and maria, described below.

Craters are round meteor impact sites covering most of the Moon's surface. With no atmosphere on the Moon, no weather conditions exist, so the only erosive force is meteor strikes. Under these conditions, lunar craters can last for millions of years.

Maria (plural for mare) are smooth, dark areas scattered across the lunar surface. These dark areas are large ancient impact basins that were filled with lava from the interior of the Moon by the depth and force of a meteor or comet impact.

Twelve Apollo astronauts left their bootprints on the Moon in the late 1960's and early 1970's. However, no telescope on Earth is able to see these footprints or any other artifacts. In fact, the smallest lunar features that may be seen with the largest telescope on Earth are about one-half mile across.

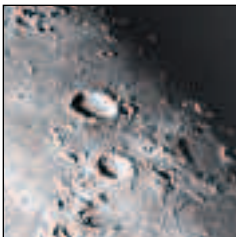

Fig. 31: The Moon. Note the deep shadows in the craters.

Planets

Planets change positions in the sky as they orbit around the Sun. To locate the planets on a given day or month, consult a monthly astronomy magazine, such as *Sky and Telescope* or *Astronomy*. Listed below are the best planets for viewing through the ETX-80AT-BB.

Venus is about nine-tenths the diameter of Earth. As Venus orbits the Sun, observers can see it go through phases (crescent, half, and full) much like those of the Moon. The disk of Venus appears white as Sunlight is reflected off the thick cloud cover that completely obscures any surface detail.

Mars is about half the diameter of Earth, and appears through the telescope as a tiny reddish-orange disk. It may be possible to see a hint of white at one of the planet's Polar ice caps. Approximately every two years, when Mars is closest to Earth in its orbit, additional detail and coloring on the planet's surface may be visible.

Jupiter is the largest planet in our solar system and is 11 times the diameter of Earth. The planet appears as a disk with dark lines stretching across the surface. These lines are cloud bands in the atmosphere. Four of Jupiter's 16 moons (Io, Europa, Ganymede, and Callisto) can be seen as "star-like" points of light when using even the lowest magnification (**Fig. 32**). These moons orbit Jupiter so that the number of moons visible on any given night changes as they circle around the giant planet.

Saturn is nine times the diameter of Earth and appears as a small, round disk with rings extending out from either side (**Fig. 33**). In 1610, Galileo, the first person to observe Saturn through a telescope, did not understand that what he was seeing were rings. Instead, he believed that Saturn had "ears." Saturn's rings are composed of billions of ice particles ranging in size from a speck of dust to the size of a house. The major division in Saturn's rings, called the Cassini Division, is occasionally visible through the ETX-80AT-BB. Titan, the largest of Saturn's 18 moons can also be seen as a bright, star-like object near the planet.

Deep-Sky Objects

Star charts can be used to locate constellations, individual stars and deep-sky objects. Examples of various deep-sky objects are given below:

Stars are large gaseous objects that are self-illuminated by nuclear fusion in their core. Because of their vast distances from our solar system, all stars appear as pinpoints of light, irrespective of the size of the telescope used.

Nebulae are vast interstellar clouds of gas and dust where stars are formed. Most impressive of these is the Great Nebula in Orion (M42), a diffuse nebula that appears as a faint wispy gray cloud. M42 is 1600 light years from Earth.

Open Clusters are loose groupings of young stars, all recently formed from the same diffuse nebula. The Pleiades is an open cluster 410 light years away (**Fig. 34**). Through the ETX-80AT-BB, numerous stars are visible.

Constellations are large, imaginary patterns of stars believed by ancient civilizations to be the celestial equivalent of objects, animals, people, or gods. These patterns are too large to be seen through a telescope. To learn the constellations, start with an easy grouping of stars, such as the Big Dipper in Ursa Major. Then, use a star chart to explore across the sky.

Galaxies are large assemblies of stars, nebulae, and star clusters that are bound by gravity. The most common shape is spiral (such as our own Milky Way), but galaxies can also be elliptical, or even irregular blobs. The Andromeda Galaxy (M31) is the closest spiral-type galaxy to our own. This galaxy appears fuzzy and cigar-shaped. It is 2.2 million light years away in the constellation Andromeda, located between the large "W" of Cassiopeia and the great square of Pegasus.

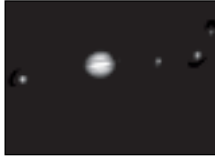

Fig. 32: Jupiter and its four largest moons. The moons can be observed in a different position every night.

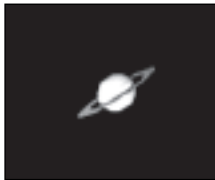

Fig. 33: Saturn has the most extensive ring structure in our Solar System.

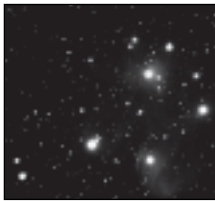

Fig. 34: The Pleiades is one of the most beautiful open clusters.



MEADE LIMITED WARRANTY

Every Meade telescope, spotting scope, and telescope accessory is warranted by Meade Instruments Corporation ("Meade") to be free of defects in materials and workmanship for a period of ONE YEAR from the date of original purchase in the U.S.A. and Canada. Meade will repair or replace a product, or part thereof, found by Meade to be defective, provided the defective part is returned to Meade, freight-prepaid, with proof of purchase. This warranty applies to the original purchaser only and is non-transferable. Meade products purchased outside North America are not included in this warranty, but are covered under separate warranties issued by Meade international distributors.

RGA Number Required: Prior to the return of any product or part, a Return Goods Authorization (RGA) number **must** be obtained from Meade by writing, or calling (949) 451-1450. Each returned part or product must include a written statement detailing the nature of the claimed defect, as well as the owner's name, address, and phone number.

This warranty is not valid in cases where the product has been abused or mishandled, where unauthorized repairs have been attempted or performed, or where depreciation of the product is due to normal wear-and-tear. Meade specifically disclaims special, indirect, or consequential damages or lost profit which may result from a breach of this warranty. Any implied warranties which cannot be disclaimed are hereby limited to a term of one year from the date of original retail purchase.

This warranty gives you specific rights. You may have other rights which vary from state to state.

Meade reserves the right to change product specifications or to discontinue products without notice.

This warranty supercedes all previous Meade product warranties.



MEADE[®]

6001 Oak Canyon, Irvine, California 92618
(800) 626-3233 ■ www.meade.com

Part no. 14-6881-00 06/00

Free Manuals Download Website

<http://myh66.com>

<http://usermanuals.us>

<http://www.somanuals.com>

<http://www.4manuals.cc>

<http://www.manual-lib.com>

<http://www.404manual.com>

<http://www.luxmanual.com>

<http://aubethermostatmanual.com>

Golf course search by state

<http://golfingnear.com>

Email search by domain

<http://emailbydomain.com>

Auto manuals search

<http://auto.somanuals.com>

TV manuals search

<http://tv.somanuals.com>