

# **Memorex<sup>®</sup>**

## **PORTABLE STEREO SYSTEM WITH CD PLAYER AND AM/FM RADIO**

### **MODEL: MP3223**

**BEFORE OPERATING THIS PRODUCT, PLEASE READ THESE  
INSTRUCTIONS COMPLETELY.**

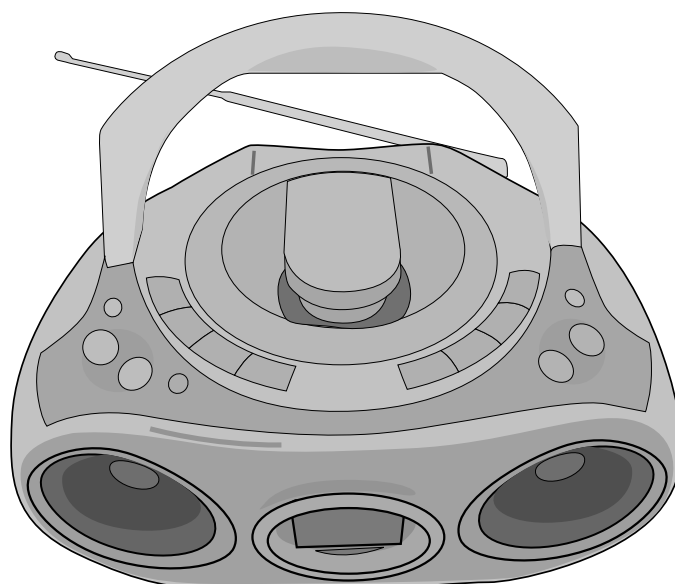

## **OPERATING INSTRUCTIONS**

Thank you for purchasing the Memorex audio system.

The serial number of your unit can be found on a label on the bottom of the cabinet. We suggest that you record the serial number in the space provided below in case this information is ever needed at a future date.

**PLEASE KEEP ALL PACKAGING MATERIAL FOR AT LEAST 90 DAYS IN CASE YOU NEED TO RETURN THIS PRODUCT TO YOUR PLACE OF PURCHASE OR MEMOREX.**

Model Number: MP3223

Serial Number: \_\_\_\_\_

	<b>CAUTION</b> <b>RISK OF ELECTRIC SHOCK</b> <b>DO NOT OPEN</b>	
<b>CAUTION:</b> TO REDUCE THE RISK OF ELECTRIC SHOCK, DO NOT REMOVE COVER (OR BACK). NO USER-SERVICEABLE PARTS INSIDE. REFER SERVICING TO QUALIFIED SERVICE PERSONNEL.		

**LASER SAFETY:** This unit employs a laser. Only qualified service personnel should attempt to service this device due to possible eye injury.

**CAUTION:** USE OF CONTROLS, ADJUSTMENTS OR PERFORMANCE PROCEDURE HEREIN MAY RESULT IN HAZARDOUS RADIATION EXPOSURE.



**DANGEROUS VOLTAGE:**

The lightning flash with arrowhead symbol, within an equilateral triangle is intended to alert the user to the presence of uninsulated dangerous voltage within the product's enclosure that may be of sufficient magnitude to constitute a risk of electric shock to persons.



**ATTENTION:**

The exclamation point within an equilateral triangle is intended to alert the user to the presence of important operating and maintenance (servicing) instructions in the literature accompanying the appliance.

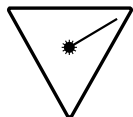

**DANGER:**

Invisible and hazardous laser radiation when open and interlock failed or defeated. Avoid direct exposure to beam.

**INFORMATION:**

This equipment has been tested and found to comply with the limits for a Class B digital device, pursuant to Part 15 of the FCC Rules. These limits are designed to provide reasonable protection against harmful interference in a residential installation. This equipment generates, uses, and can radiate radio frequency energy and, if not installed and used in accordance with the instructions, may cause harmful interference to radio communications. However, there is no guarantee that interference will not occur in a particular installation. If this equipment does cause harmful interference to radio or television reception, which can be determined by turning the equipment off and on, the user is encouraged to try to correct the interference by one or more of the following measures:

- Reorient or relocate the receiving antenna.
- Increase the separation between the equipment and receiver.
- Connect the equipment into an outlet on a circuit different from that to which the receiver is connected.
- Consult the dealer or an experienced radio/TV technician for help.

**FCC WARNING:**

This equipment may generate or use radio frequency energy. Changes or modifications to this equipment may cause harmful interference unless the modifications are expressly approved in the instruction manual. The user could lose the authority to operate this equipment if an unauthorized change or modification is made.

**SURGE PROTECTORS:**

It is recommended to use a surge protector for AC connection. Lightning and power surges ARE NOT covered under warranty for this product.

# SAFETY INSTRUCTIONS

Before using the unit, be sure to read all operating instructions carefully. Please note that these are general precautions and may not pertain to your unit. For example, this unit may not have the capability to be connected to an outdoor antenna.

## 1. READ INSTRUCTIONS

All the safety and operating instructions should be read before the product is operated.

## 2. RETAIN INSTRUCTIONS

The safety and operating instructions should be retained for future reference.

## 3. HEED WARNINGS

All warnings on the product and in the operating instructions should be adhered to.

## 4. FOLLOW INSTRUCTIONS

All operating and use instructions should be followed.

## 5. CLEANING

Unplug this product from the wall outlet before cleaning. Do not use liquid cleaners or aerosol cleaners. Use a damp cloth for cleaning.

## 6. ATTACHMENTS

Do not use attachments not recommended by the product's manufacturer as they may cause hazards.

## 7. WATER AND MOISTURE

Do not use this product near water- for example, near a bathtub, washbowl, kitchen sink, or laundry tub, in a wet basement, or near a swimming pool.

## 8. ACCESSORIES

Do not place this product on an unstable cart, stand, tripod, bracket, or table. The product may fall, causing serious injury and serious damage to the product. Use only with a cart, stand, tripod, bracket, or table recommended by the manufacturer or sold with the product. Any mounting of the product should follow the manufacturer's instructions, and should use a mounting accessory recommended by the manufacturer.

- 8A. An appliance and cart combination should be moved with care. Quick stops, excessive force, and uneven surfaces may cause the appliance and cart combination to overturn.

PORTABLE CART WARNING  
(symbol provided by RETAC)



## 9. VENTILATION

Slots and openings in the cabinet and in the back or bottom are provided for ventilation and to ensure reliable operation of the product and to protect it from overheating. These openings must not be blocked or covered. The openings should never be blocked by placing the product on a bed, sofa, rug, or other similar surface. This product should never be placed near or over a radiator or heat source. This product should not be placed in a built-in installation such as a bookcase or rack unless proper ventilation is provided or the manufacturer's instructions have been adhered to.

## 10. POWER SOURCES

This product should be operated only from the type of power source indicated on the marking label. If you are not sure of the type of power supply to your home, consult your appliance dealer or local power company. For products intended to operate from battery power, or other sources, refer to the operating instructions.

## 11. GROUNDING OR POLARIZATION

This product is equipped with a polarized alternating-current line plug (a plug having one blade wider than the other). This plug will fit into the power outlet only one way. This is a safety feature. If you are unable to insert the plug fully into the outlet, try reversing the plug. If the plug should still fail to fit, contact your electrician to replace your obsolete outlet. Do not defeat the safety purpose of the polarized plug.

## 12. POWER-CORD PROTECTION

Power-supply cords should be routed so that they are not likely to be walked on or pinched by items placed upon or against them, paying particular attention to cords at plugs, convenience receptacles, and the point where they exit from the appliance.

## 13. LIGHTNING

To protect your product from a lightning storm, or when it is left unattended and unused for long periods of time, unplug it from the wall outlet and disconnect the antenna or cable system. This will prevent damage to the product due to lightning and power-line surges.

## 14. POWER LINES

An outside antenna system should not be located in the vicinity of overhead power lines or other electric light or power circuits, or where it can fall into such power lines or circuits. When installing an outside antenna system, extreme care should be taken to keep from touching such power lines or circuits as contact with them might be fatal.

## 15. OVERLOADING

Do not overload wall outlets and extension cords as this can result in a risk of fire or electric shock.

## 16. OBJECT AND LIQUID ENTRY

Never push objects of any kind into this product through openings as they may touch dangerous voltage points or short out parts that could result in fire or electric shock. Never spill or spray any type of liquid on the product.

## 17. OUTDOOR ANTENNA GROUNDING

If an outside antenna is connected to the product, be sure the antenna system is grounded so as to provide some protection against voltage surges and built-up static charges. Section 810 of the National Electric Code, ANSI/NFPA 70, provides information with respect to proper grounding of the mast and supporting structure, grounding of the lead-in wire to an antenna discharge product, size of grounding conductors, location of antenna discharge product, connection to grounding electrodes, and requirements for grounding electrode.

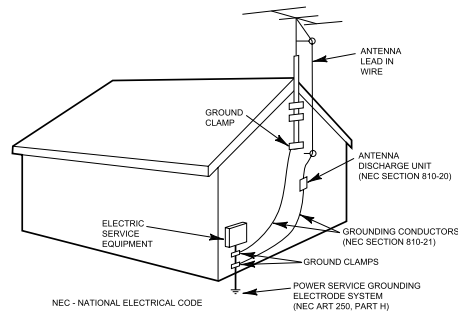

EXAMPLE OF ANTENNA GROUNDING AS PER NATIONAL ELECTRICAL CODE

## 18. SERVICING

Do not attempt to service this product yourself as opening or removing covers may expose you to dangerous voltage or other hazards. Refer all servicing to qualified service personnel.

## 19. REPLACEMENT PARTS

When replacement parts are required, be sure the service technician uses replacement parts specified by the manufacturer or those that have the same characteristics as the original part. Unauthorized substitutions may result in fire, electric shock or other hazards.

## 20. SAFETY CHECK

Upon completion of any service or repairs to this product, ask the service technician to perform safety checks to determine that the product is in proper operating condition.

## 21. WALL OR CEILING MOUNTING

The product should be mounted to a wall or ceiling only as recommended by the manufacturer.

## 22. DAMAGE REQUIRING SERVICE

Unplug the product from the wall outlet and refer servicing to qualified service personnel under the following conditions:

- When the power-supply cord or plug is damaged.
- If liquid has been spilled, or objects have fallen into the product.
- If the product has been exposed to rain or water.
- If the product does not operate normally by following the operating instructions. Adjust only those controls that are covered by the operating instructions, as an adjustment of other controls may result in damage and will often require extensive work by a qualified technician to restore the product to its normal operation.
- If the product has been dropped or the cabinet has been damaged.
- When the product exhibits a distinct change in performance - this indicates a need for service.

## 23. HEAT

The product should be situated away from heat sources such as radiators, heat registers, stoves, or other products (including amplifiers) that produce heat.

## 24. NOTE TO CATV SYSTEM INSTALLER

This reminder is provided to call the CATV system installer's attention to Article 820-40 of the NEC that provides guidelines for proper grounding and, in particular, specifies that the cable ground shall be connected to the grounding system of the building, as close to the point of cable entry as practical.

## PREPARATION FOR USE

### Unpacking and Setup

- Carefully remove the unit from the display carton and remove all packing material from the unit itself.
- The detachable AC power cord is packed in the carton separately from the unit. Make sure that the AC power cord is not accidentally discarded with the carton or packing material.
- Press the CD Door OPEN/CLOSE area to open the CD compartment door. There is a white card in the CD compartment which is intended to prevent the CD pickup from moving during shipment of the product. Remove this card from the CD compartment before use.

### Power Sources

This portable audio system is designed to operate on either 120V AC 60Hz house current DC or by using eight (8) 'C' batteries, not included. Attempting to operate this unit from any other power source may cause damage to the unit, which is not covered by your warranty.

### AC Operation

Unwind the AC cord and extend it to its full length. Insert the small end of the AC cord into the AC power jack on the rear of the unit. Insert the other end of the AC cord into any convenient 120V 60Hz household outlet.

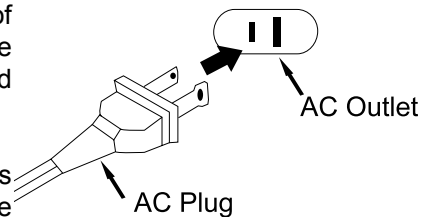

Please note that this unit is equipped with a polarized AC plug which has one blade wider than the other. This is a safety feature to reduce the likelihood of electric shock. This polarized AC plug will only fit in a polarized AC outlet. If you find that you cannot insert this plug into your outlet, you may have an obsolete non-polarized outlet. Please do not try to defeat this safety feature by using a non-polarized adapter or by filing the wider blade to make it fit into your outlet. If this plug does not fit into your outlet, you should contact a qualified licensed electrician to replace your obsolete outlet.

### Battery Installation

To use this unit with battery power, remove the battery compartment on the bottom of the unit by sliding it towards the rear of the unit and lifting the battery door off. Insert eight (8) 'C' size batteries following the diagram in the compartment.

**NOTE:** The AC power cord must be disconnected from the AC power jack on the rear of the unit in order for the unit to operate on battery power.

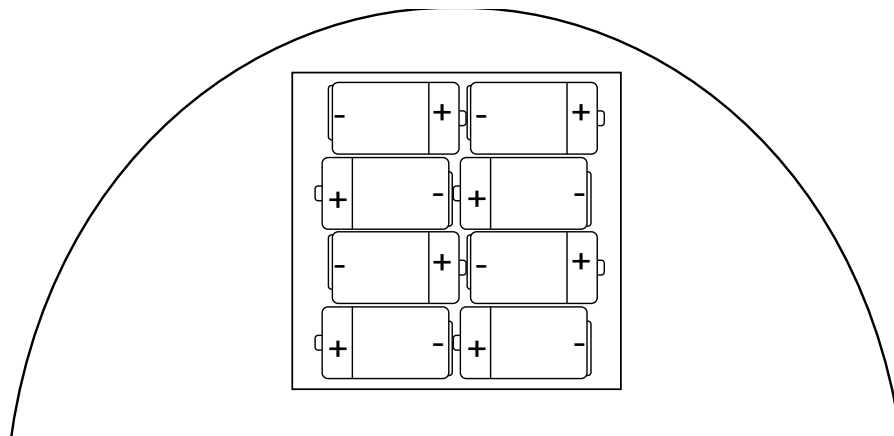

## LOCATION OF CONTROLS

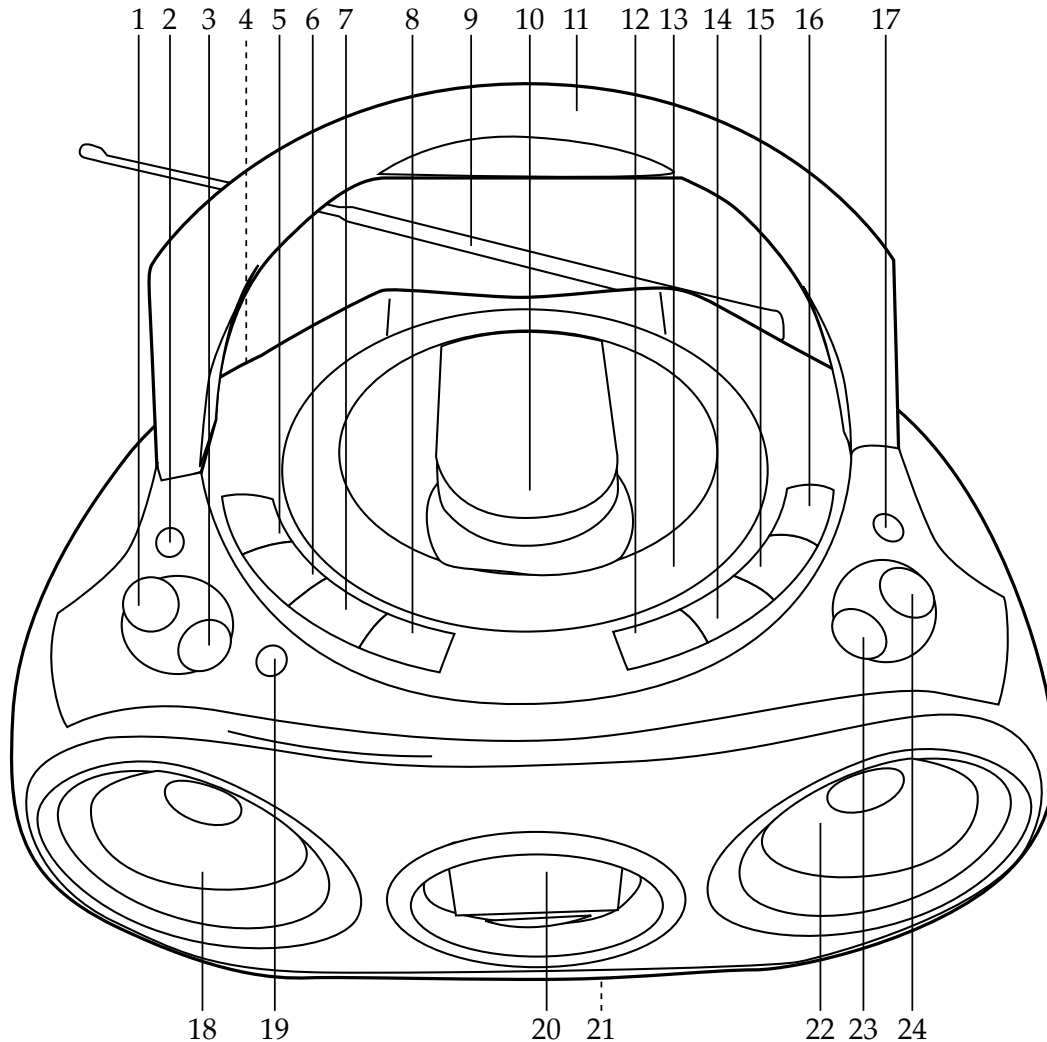

- |                                     |  |
|-------------------------------------|--|
| 1. CD Function Button               | 13. CD Door OPEN/CLOSE Area              |
| 2. TIMER/SLEEP Button               | 14. STOP (■)/BAND Button                 |
| 3. RADIO Function Button            | 15. TUNING/SKIP/Search DOWN Button       |
| 4. AC Power Jack (Rear of Unit)     | 16. TUNING/SKIP/Search UP Button         |
| 5. REPEAT/MEM-UP (Memory Up) Button | 17. POWER ON/OFF Button                  |
| 6. MEMORY/CLOCK ADJ (Adjust) Button | 18. Speaker                              |
| 7. VOLUME Up Button                 | 19. X-BASS Button                        |
| 8. VOLUME Down Button               | 20. Display with Back Light              |
| 9. FM Rod Antenna                   | 21. Battery Compartment (Bottom of Unit) |
| 10. CD Compartment                  | 22. Speaker                              |
| 11. Carrying Handle                 | 23. COLOR Cycle Button                   |
| 12. PLAY/PAUSE (▶/  ) Button        | 24. COLOR Hold Button                    |

# OPERATING INSTRUCTIONS

## SETTING THE CLOCK

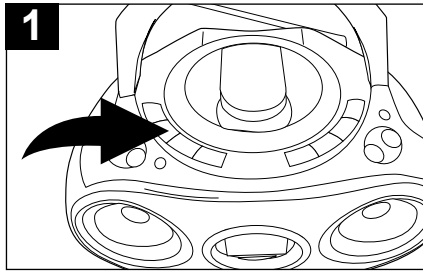

**1** With the power off, press and hold the MEMORY/CLOCK ADJ button; "24H" will blink.

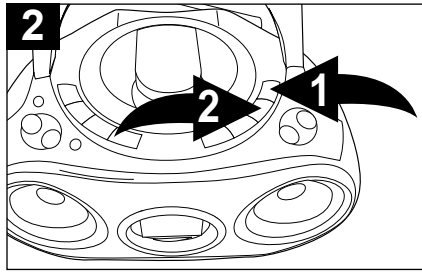

**2** Press the TUNING/SKIP/Search UP **1** or DOWN **2** button to set the unit to the 24 hour (24H) mode (also known as military time), or 12 hour (12H) mode.

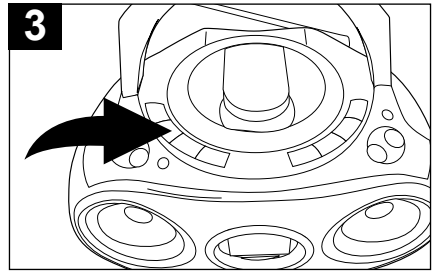

**3** Press the MEMORY/CLOCK ADJ button and the hours will blink.

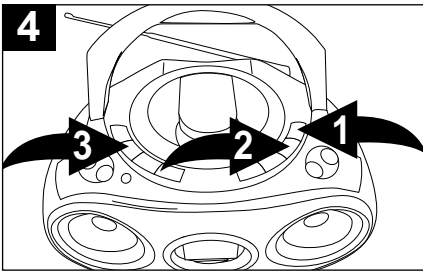

**4** Press the TUNING/SKIP/Search UP **1** or DOWN **2** button to set the current hour, then press the MEMORY/CLOCK ADJ button **3** again; the minute digits will blink.

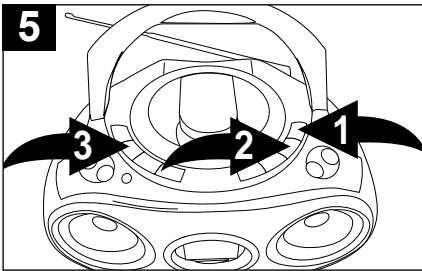

**5** Press the TUNING/SKIP/Search UP **1** or DOWN **2** button to set the current minute. Press the MEMORY/CLOCK ADJ button **3** and the time will be set.

## X-BASS

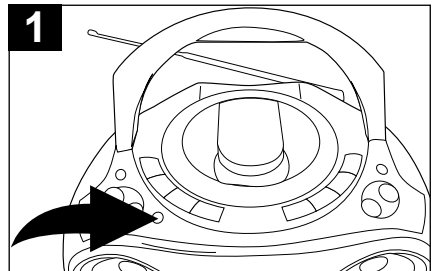

**1** With the power on, press the X-BASS button to enhance the overall bass sound; "X-BASS" will appear in the display.

## COLOR BUTTONS

When the unit is on, the display will cycle through the colors of the selected Color options - experiment for your favorite color sequence! Change the color selection, or hold a particular color as follows:

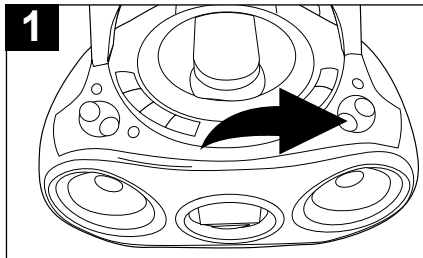

**1** When the unit is on, press the COLOR Cycle button to cycle through the 14 color options. Each option will display a different color sequence in the display.

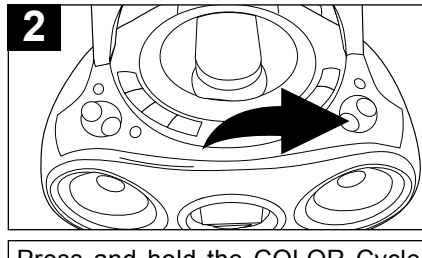

**2** Press and hold the COLOR Cycle button until RHYTHM appears in the display, then release. The display color will then change according to the rhythm of the music. Press and hold the COLOR Cycle button again until RHYTHM disappears from the display to cancel Rhythm.

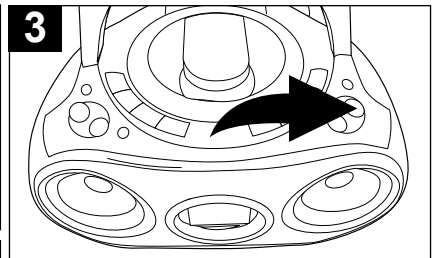

**3** To leave one solid color in the display, press the COLOR Hold button; HOLD will appear in the display. Press the COLOR Hold button again to continue the color cycling.

## LISTENING TO THE RADIO

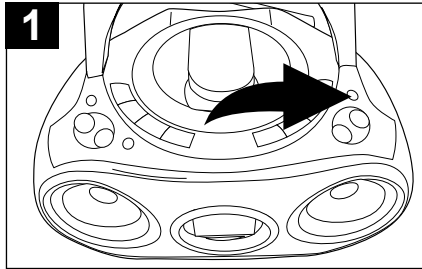

1 Press the POWER ON/OFF button to turn the unit on.

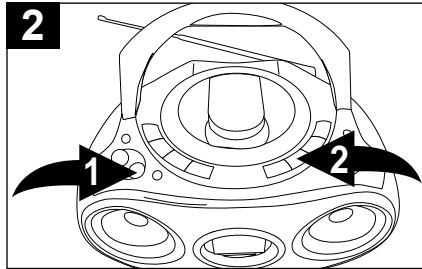

2 Press the RADIO Function button ❶ to select the Tuner mode. Press the STOP (■)/BAND button ❷ to select AM or FM.

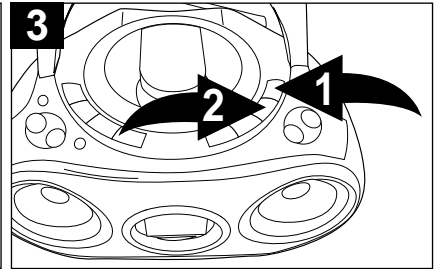

3 Use the TUNING/SKIP/Search UP ❶ or TUNING/SKIP/Search DOWN ❷ button to select the desired AM or FM station. When a strong FM Stereo signal is received, the FM Stereo indicator will light.

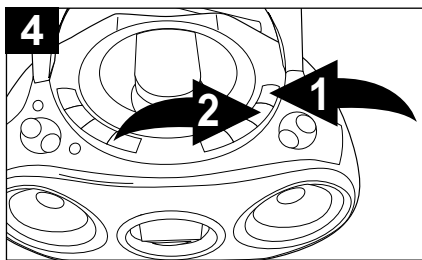

4 If you press and hold the TUNING/SKIP/Search UP ❶ or TUNING/SKIP/Search DOWN ❷ button for one second, then release, the unit will automatically scan to the next broadcasting station.

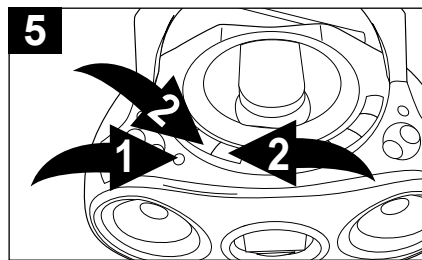

5 For an enhanced Bass sound, press the X-BASS button ❶. Adjust the VOLUME ❷ as desired.

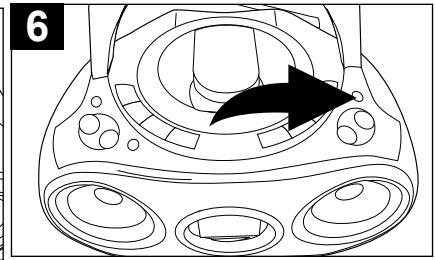

6 Press the POWER ON/OFF button to turn the radio off.

## HINTS FOR BETTER RECEPTION

FM - Make sure that the telescopic FM Rod Antenna is raised and extended to its full length. You may have to vary the direction of the antenna to find the strongest signal for each FM station.

AM - The AM ferrite bar antenna is located inside the cabinet. It may be necessary to turn the unit slightly so that the internal antenna is pointing in the direction of the AM transmitter. You may have to experiment to find the position that provides the strongest reception for each of your favorite AM stations.

## TO SET/RECALL THE RADIO PRESETS (10 AM and 10 FM)

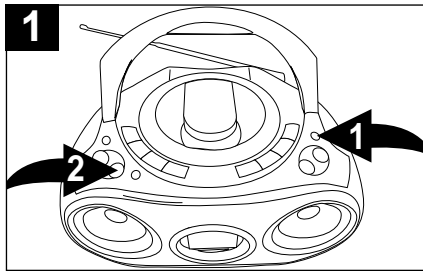

Press the POWER ON/OFF button ❶ to turn the unit on. Press the RADIO Function button ❷ to select the Tuner mode.

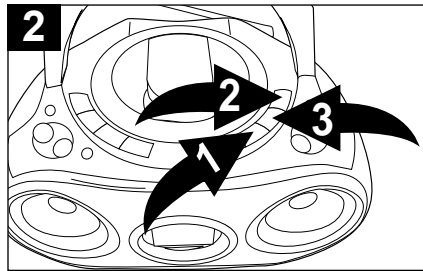

Press the STOP (■)/BAND button ❶ to select AM or FM. Use the TUNING/SKIP/Search UP ❷ or TUNING/SKIP/Search DOWN ❸ button to select the desired AM or FM station.

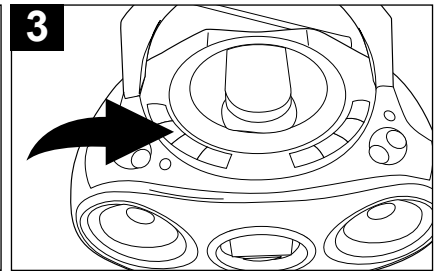

Press the MEMORY/CLOCK ADJ button; "MEMORY" will blink in the display and a preset number will appear.

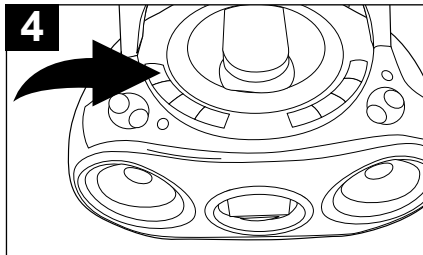

Select the desired preset number (up to 10) by repeatedly pressing the REPEAT/MEM-UP button.

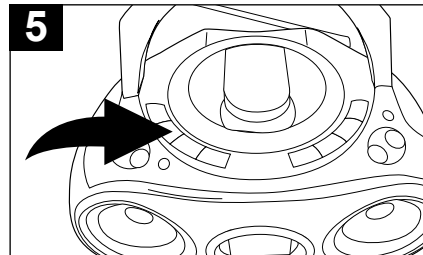

Press the MEMORY/CLOCK ADJ button again to set the preset. Repeat steps 2 through 4 to set more presets.

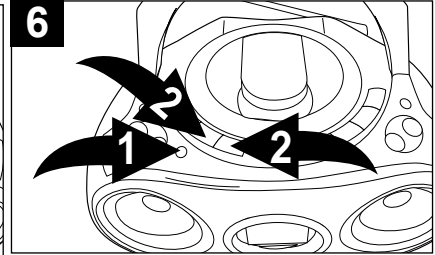

For an enhanced Bass sound, press the X-BASS button ❶. Adjust the VOLUME ❷ as desired.

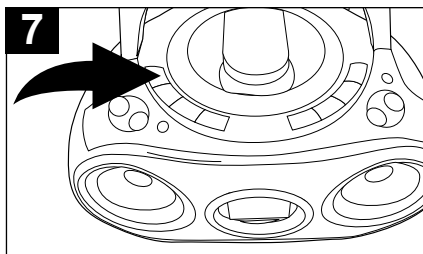

Select the desired preset number (up to 10 each band) by repeatedly pressing the REPEAT/MEM-UP button.



## PLAYING COMPACT DISCS

### NORMAL PLAYBACK

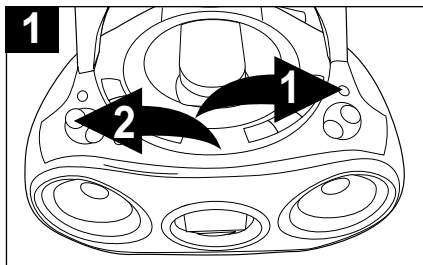

Press the **POWER ON/OFF** button ❶ to turn the unit on. Press the **CD Function** button ❷ to select the CD mode.

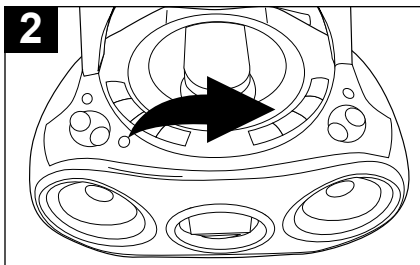

Open the CD compartment lid by pressing the **CD Door OPEN/CLOSE** area.

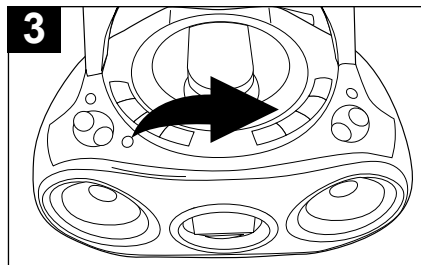

Insert a disc, label side up, into the compartment. Press the **CD Door OPEN/CLOSE** area to close the CD compartment lid; the total tracks and playing time will appear in the display.

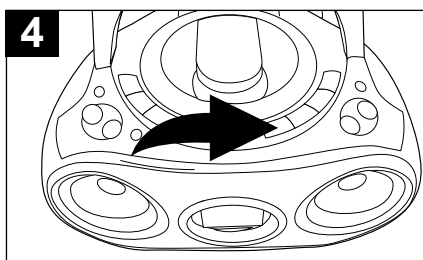

Press the **PLAY/PAUSE** (▶||) button to begin playback; the current track and elapsed playing time will appear in the display.

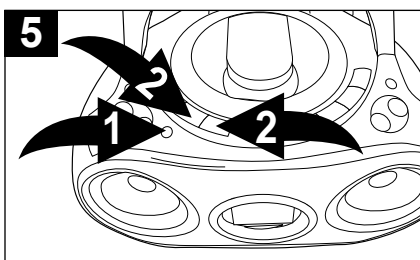

For an enhanced Bass sound, press the **X-BASS** button ❶. Adjust the **VOLUME** ❷ as desired.

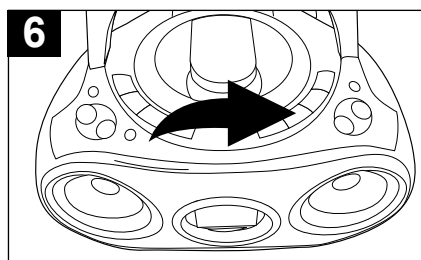

When the disc is through playing, it will stop. Press the **STOP** (■)/**BAND** button to stop the disc before it is finished.

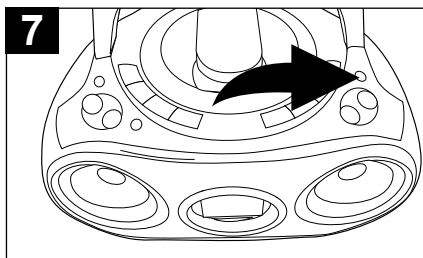

Press the **POWER ON/OFF** button to turn the CD off.

#### NOTES:

- If a disc is inserted incorrectly, dirty, damaged or not present at all, "no DISC" will appear in the display.
- As each track is played, the track number and playing time is shown in the display.
- To prevent damage to the disc, never open the CD door while the disc is rotating. Wait for the disc to stop before opening the CD door. Never touch the lens when the CD compartment door is open.
- DO NOT use the carrying handle when playing a CD. The CD should only be used on a steady surface.
- This unit will play 3" CD singles, no adapter is needed.
- The maximum playing time is 74 minutes.



## CD PAUSE CONTROL

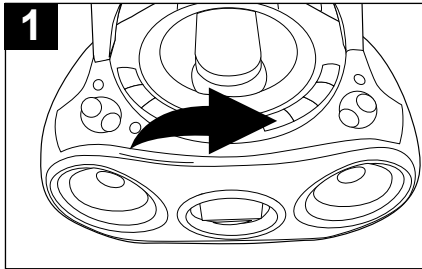

**1** During CD playback, if you wish to pause the disc momentarily, press the PLAY/PAUSE (▶||) button. Playback stops but the disc continues to spin and the time blinks in the display.

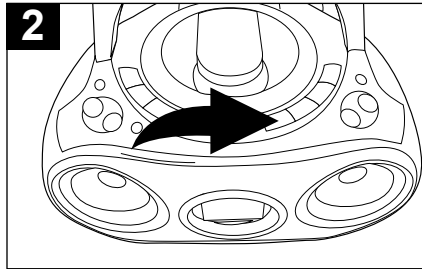

**2** Press the PLAY/PAUSE (▶||) button again to release pause and resume normal CD playback. The sound returns and the time stops blinking.

## TO BEGIN PLAYBACK FROM A SPECIFIC TRACK

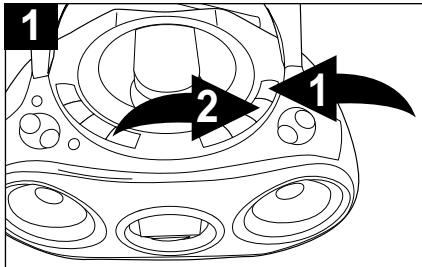

**1** After you insert the disc into the CD player and the total number of tracks and playing time appear on the display, you may press the TUNING/SKIP/Search UP **1** or DOWN **2** button to select a specific track for playback.

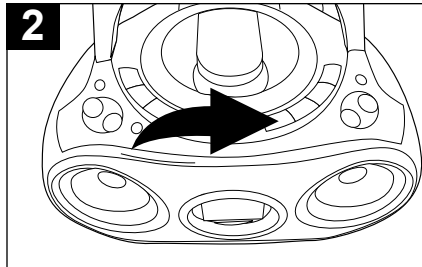

**2** When the desired track number appears in the display, press the PLAY/PAUSE (▶||) button. Playback will begin on the track you selected.

## FORWARD/REVERSE SKIP TRACK AND HIGH-SPEED MUSIC SEARCH

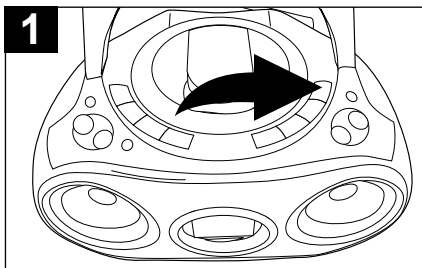

**1** During playback, press the TUNING/SKIP/Search UP button once to advance the player to the beginning of the next track. Press the TUNING/SKIP/Search UP button repeatedly to advance the player to higher numbered tracks.

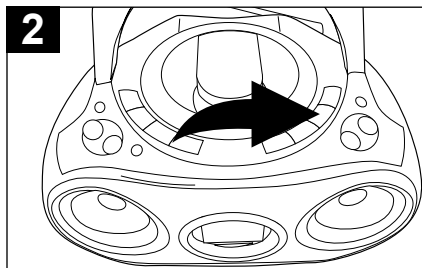

**2** During playback, press the TUNING/SKIP/Search DOWN button once to move the player back to the beginning of the playing track. Press the TUNING/SKIP/Search DOWN button repeatedly to move the player back to lower numbered tracks.

**3** During playback, press and hold either the TUNING/SKIP/Search UP **1** or DOWN **2** button to move the player forward or backward within a track to locate a specific musical passage. The player will move forward or backward at high speed as long as the buttons are depressed. When you release the TUNING/SKIP/Search UP **1** or DOWN **2** button, normal playback will resume.

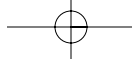

## TO REPEATEDLY PLAY BACK ONE TRACK/ALL TRACKS

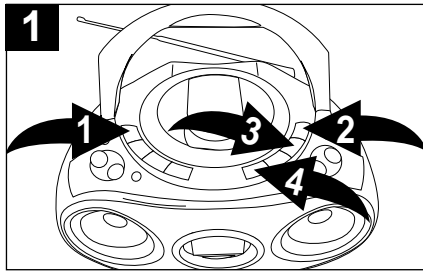

To repeat a single track, press the REPEAT/MEM-UP button ❶ once while in the Stop mode; REPEAT will blink in the display. Press the TUNING/SKIP/Search UP ❷ or DOWN ❸ button to select the specific track that you wish to repeat. When the desired track number appears in the display, press the PLAY/PAUSE (▶||) button ❹ to begin playback. The specific track you selected will be repeated continuously. You can press the REPEAT/MEM-UP button ❶ once during playback to repeat the current track continuously.

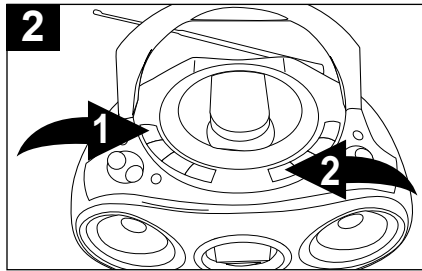

To repeat all of the tracks on a disc continuously, press the REPEAT/MEM-UP button ❶ twice while in the Stop mode; REPEAT will appear in the display. Press the PLAY/PAUSE (▶||) button ❷ to begin playback; all the tracks on the CD will repeat continuously.

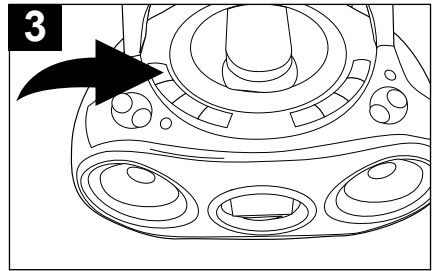

To cancel Repeat Playback, press the REPEAT/MEM-UP button until the Repeat indicator disappears from the display.

## PROGRAMMED PLAYBACK

The CD player in this unit has a 20 track programmable memory that allows you to program up to 20 tracks on any disc for playback in any desired order. You may program 20 different tracks or you may also program certain tracks to play more than once.

To perform programmed playback, proceed as follows:

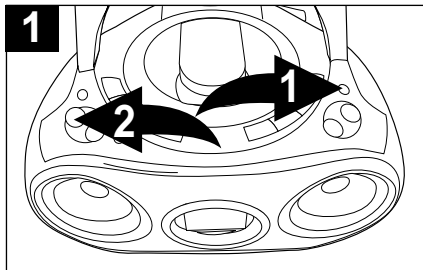

Press the POWER ON/OFF button ❶ to turn the unit on. Press the CD Function button ❷ to select the CD mode.

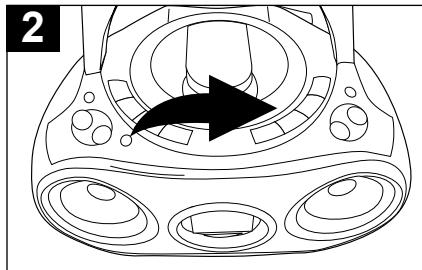

Open the CD compartment lid by pressing the CD Door OPEN/CLOSE area and insert your disc in the CD player. Close the CD compartment door.

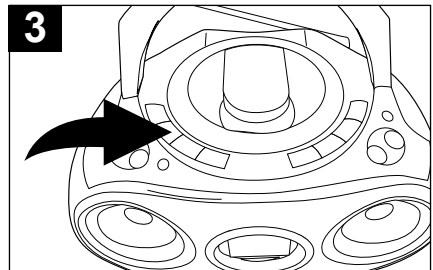

Press the MEMORY/CLOCK ADJ button; "P-01" (Program Number) and "1" (track number) will appear and "MEMORY" will blink in the display.

PROGRAMMED PLAYBACK SECTION CONTINUED ON NEXT PAGE.



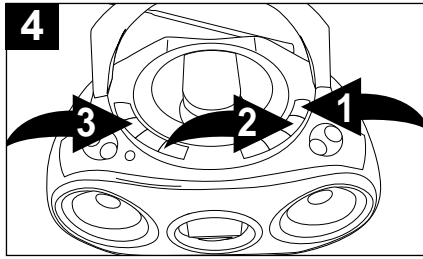

Press the TUNING/SKIP/Search UP ❶ or DOWN ❷ button to select the first track that you wish to program. When the desired track number (Example: Track 5) appears in the display, press the MEMORY/CLOCK ADJ button ❸ again. Then press the TUNING/SKIP/Search UP ❶ or DOWN ❷ button repeatedly to select a second track, the display will then show, "P-02" indicating program 2 is ready to be set.

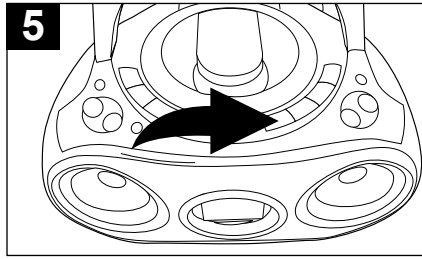

After programming up to 20 tracks in the CD Program Memory, press the PLAY/PAUSE (▶||) button to begin programmed playback; "MEMORY" will appear in the display and playback will begin on the first track that you programmed. The player will continue to play all of the tracks that you programmed in the order in which you programmed them.

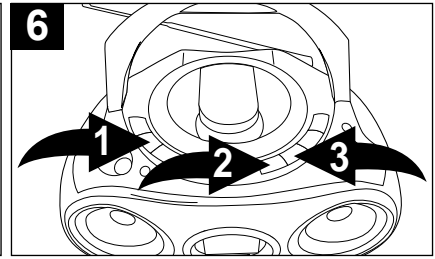

When the last programmed track has been played, the player will stop. To begin the programmed playback again, press the MEMORY/CLOCK ADJ button ❶, then the PLAY/PAUSE (▶||) button ❷ to begin programmed playback again. To cancel the Programmed Playback mode, press the MEMORY/CLOCK ADJ button ❶ (while in the Stop mode) to enter the Program mode and then press the STOP (■)/BAND button ❸ to cancel.

#### NOTES ON PROGRAMMED PLAYBACK:

- You can review the program by pressing the MEMORY/CLOCK ADJ button repeatedly when playback is stopped.
- You can change tracks in a program by simply selecting the desired track using the MEMORY/CLOCK ADJ button, and then use the TUNING/SKIP/Search UP or DOWN button to change it and press the MEMORY/CLOCK ADJ button again to confirm.
- Press the STOP (■)/BAND button to stop the program before it is finished.
- You can skip through the program while it is playing using the TUNING/SKIP/Search UP or DOWN button.

#### PROGRAMMED REPEAT

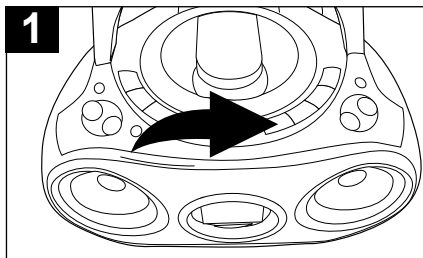

It is also possible to use the Program and Repeat functions together to repeat a specific program indefinitely. First, program the tracks you wish to hear in the order you wish to hear them, as described on the previous page. Then, press the PLAY/PAUSE (▶||) button to begin program playback.

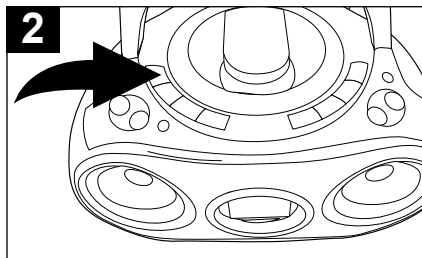

Press the REPEAT/MEM-UP button twice; both indicators will appear in the display. The player will play the tracks you selected in the order in which you programmed them. When the last track in the program has been played, the entire program will begin again.

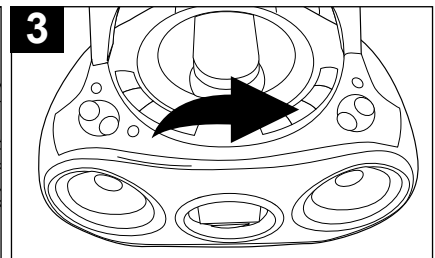

Programmed Repeat operation will continue indefinitely until you press the STOP (■)/BAND button, or turn the unit off.



## SETTING THE TIMER

Set the timer to turn the unit on to the Tuner or CD mode at a preset time as follows :

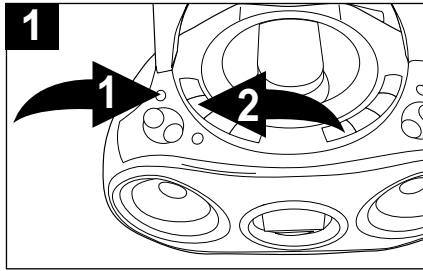

With the power off, press and hold the **TIMER/SLEEP** button ❶ until "TIMER" blinks in the display. Immediately press and hold the **MEMORY/CLOCK ADJ** button ❷ until the hours blink in the display.

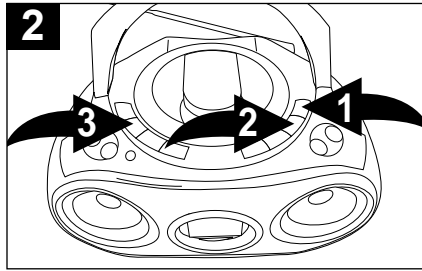

Press the **TUNING/SKIP/Search UP** ❶ or **DOWN** ❷ button to set the hour, then press the **MEMORY/CLOCK ADJ** button ❸ again; the minute digits will blink. Press the **TUNING/SKIP/Search UP** ❶ or **DOWN** ❷ button to set the minutes, then press the **MEMORY/CLOCK ADJ** button ❸ again.

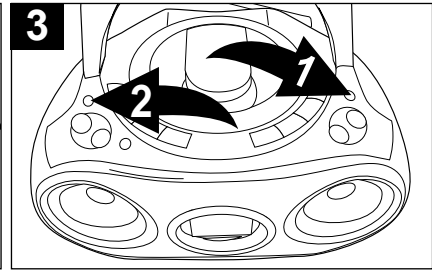

Within a few seconds, "TIMER" will light in the display to indicate that the timer is set. When the actual time matches the time set for the Timer, the unit will turn on to the last function (CD or tuner) used.  
**TO TURN THE TIMER OFF AND SET IT FOR THE NEXT DAY,** press the **POWER ON/OFF** button ❶.  
**TO TURN THE TIMER OFF SO IT IS NOT SET FOR THE NEXT DAY,** press and hold the **TIMER/SLEEP** button ❷ again until "TIMER" disappears from the display.

The unit will revert back to standby mode one hour after the timer has been activated.

## ACTIVATING THE SLEEP FUNCTION

Set the sleep timer as follows:

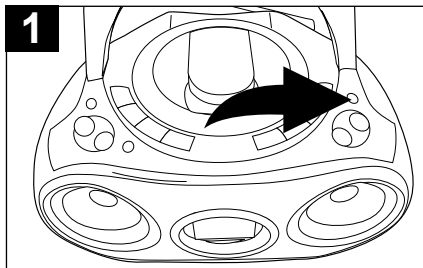

Press the **POWER ON/OFF** button to turn the unit on and tune the desired radio station or insert a CD as previously instructed.

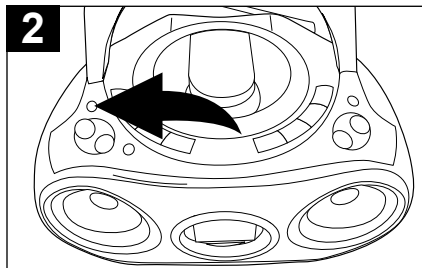

Press the **TIMER/SLEEP** button and "90" will appear and "SLEEP" will blink in the display.

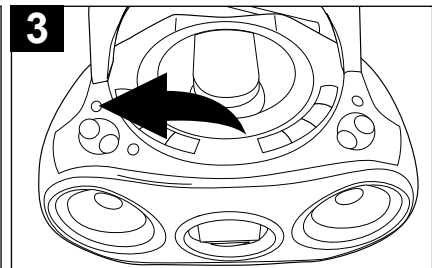

Press the **TIMER/SLEEP** button a second time to set the unit to turn off after 80 minutes. Each additional press will decrease the sleep time by 10 minutes. After five seconds the sleep timer is set, "SLEEP" will appear in the display, you can press the **TIMER/SLEEP** function button at any time to stop the Sleep function; "SLEEP" will disappear from the display.

## CARE AND MAINTENANCE

### Caring for Compact Discs

- Treat the disc carefully. Handle the compact disc only by its edges. Never allow your fingers to come in contact with the shiny, unprinted side of the compact disc.
- Do not attach adhesive tape, stickers, etc. to the compact disc label.
- Clean the compact disc periodically with a soft, lint-free, dry cloth. Never use detergents or abrasive cleaners to clean the compact disc. If necessary, use a CD cleaning kit.
- If a compact disc skips or gets stuck on a section of the compact disc, it is probably dirty or damaged (scratched).
- When cleaning the compact disc, wipe in straight lines from the center of the compact disc to the outer edge of the compact disc. Never wipe in circular motions.

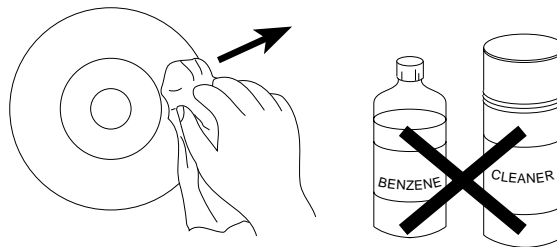
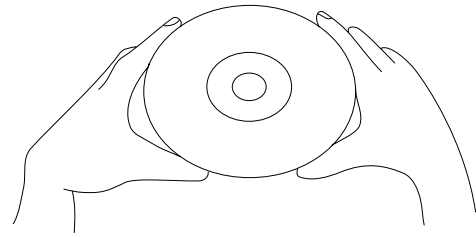

- This unit is designed to play only compact discs bearing the identification logo as shown here.
- Compact Discs should be stored in their cases after each use to avoid damage.
- Do not expose compact discs to direct sunlight, high humidity, high temperatures, or dust, etc. Prolonged exposure or extreme temperatures can warp the disc.
- Do not stick or write anything on either side of the disc. Sharp writing instruments, or the ink may damage the surface.



### Cleaning the unit

- To prevent fire or shock hazard, disconnect your unit from the AC power source when cleaning.
- The finish on your unit may be cleaned with a dust cloth and cared for as other furniture. Use caution when cleaning and wiping the plastic parts.
- Mild soap and a damp cloth may be used on the front panel.

## TROUBLESHOOTING GUIDE

Should this unit exhibit a problem, check the following before seeking service.

Symptom	Possible Cause	Solution
<b>Radio</b>		
Noise or sound distorted on radio broadcasts.	Station not tuned properly for AM or FM.	Retune the AM or FM broadcast station.
	FM: Telescopic antenna is not properly adjusted.	Reorient FM telescopic antenna.
	AM: Unit is not positioned correctly.	Rotate unit until best reception is obtained.
AM or FM, no sound.	RADIO Function button not pressed.	Press the RADIO Function button.
	Volume at minimum.	Increase volume.
<b>Compact Disc Player</b>		
CD Player will not play.	CD Function button not pressed.	Press the CD Function button.
	CD is not installed or installed upside-down.	Insert CD with label side up.
CD skips while playing.	Disc is dirty or scratched.	Wipe disc with cloth or use another disc.
<b>General</b>		
No sound.	Power cord disconnected.	Connect power cord.
	No batteries, or weak, dead or inserted incorrectly.	Insert fresh batteries correctly.

**FOR ADDITIONAL SET-UP OR OPERATING ASSISTANCE, PLEASE VISIT OUR WEBSITE AT [WWW.MEMOREXELECTRONICS.COM](http://WWW.MEMOREXELECTRONICS.COM) OR CONTACT CUSTOMER SERVICE AT 1-800-919-3647**

**PLEASE KEEP ALL PACKAGING MATERIAL FOR AT LEAST 90 DAYS IN CASE YOU NEED TO RETURN THIS PRODUCT TO YOUR PLACE OF PURCHASE OR MEMOREX.**

**FOR PARTS AND ACCESSORIES, CONTACT FOX INTERNATIONAL AT 1-800-321-6993.**

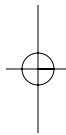
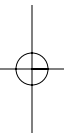
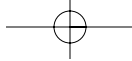

Memcorp, Inc.  
Weston, FL  
Printed in Hong Kong

Visit our website at [www.memorexelectronics.com](http://www.memorexelectronics.com)





## Free Manuals Download Website

<http://myh66.com>

<http://usermanuals.us>

<http://www.somanuals.com>

<http://www.4manuals.cc>

<http://www.manual-lib.com>

<http://www.404manual.com>

<http://www.luxmanual.com>

<http://aubethermostatmanual.com>

Golf course search by state

<http://golfingnear.com>

Email search by domain

<http://emailbydomain.com>

Auto manuals search

<http://auto.somanuals.com>

TV manuals search

<http://tv.somanuals.com>