

# Miele

NOVOTRONIC SUPER

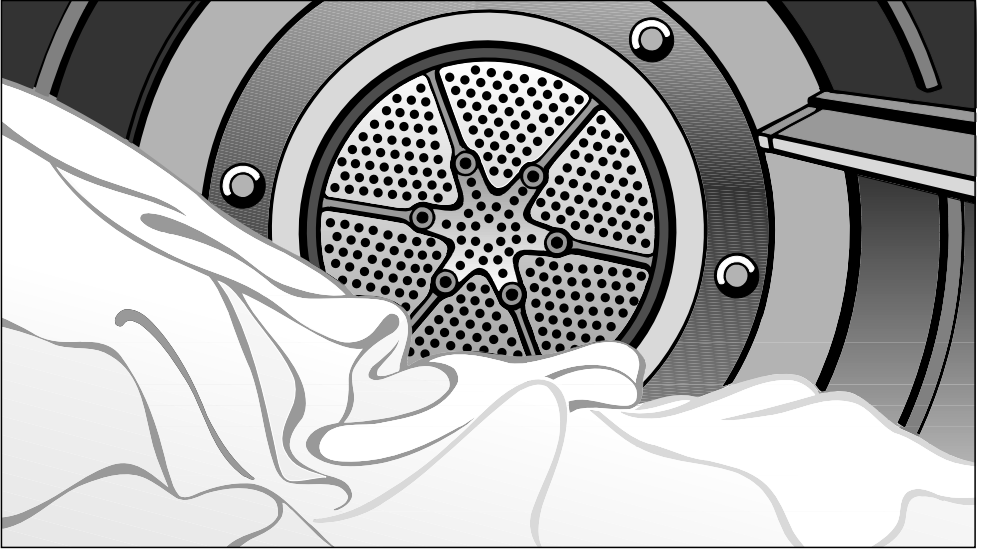

## Operating instructions for condenser tumble dryer T 699 C

It is **essential** to read these operating instructions before installing or using the machine to avoid the risk of accident, or damage to the machine.



M.-Nr. 04 943 440

# Contents

---

<b>Guide to the appliance</b> . . . . .	4
<b>Caring for the environment</b> . . . . .	6
<b>Warning and safety instructions</b> . . . . .	7
<b>Brief instructions</b> . . . . .	10
<b>Notes on laundry care</b> . . . . .	11
<b>How to dry correctly</b>	
Hints on saving energy . . . . .	12
Switching on and loading . . . . .	12
Selecting a programme . . . . .	13
Selecting additional options . . . . .	14
Starting a programme . . . . .	14
After drying . . . . .	14
<b>Additional options</b> . . . . .	15
<b>Programme chart</b> . . . . .	16
<b>Display</b> . . . . .	18
<b>Delay start</b> . . . . .	19
<b>Altering a programme</b> . . . . .	20
<b>Electronic system lock</b> . . . . .	21
<b>Programmable functions</b>	
Notes . . . . .	22
Activating and storing in the memory . . . . .	23

## **Cleaning and care**

Cleaning the fluff filters. . . . .	24
Cleaning the tumble dryer . . . . .	24
Emptying the condensed water container . . . . .	25
Cleaning the condenser unit . . . . .	26

## **Problem solving guide**

What to do if ... . . . . .	28
-----------------------------	----

## **After sales service**

Repairs. . . . .	32
Future updates . . . . .	32

## **Installation**

Installation . . . . .	33
Fitting or changing the decor panel . . . . .	34
Fitting the plinth fascia. . . . .	35
External condensed water outlet . . . . .	36

<b>Electrical connection</b> . . . . .	38
--	----

<b>Consumption data</b> . . . . .	39
-----------------------------------	----

<b>Technical data</b> . . . . .	40
---------------------------------	----

# Guide to the appliance

## General view

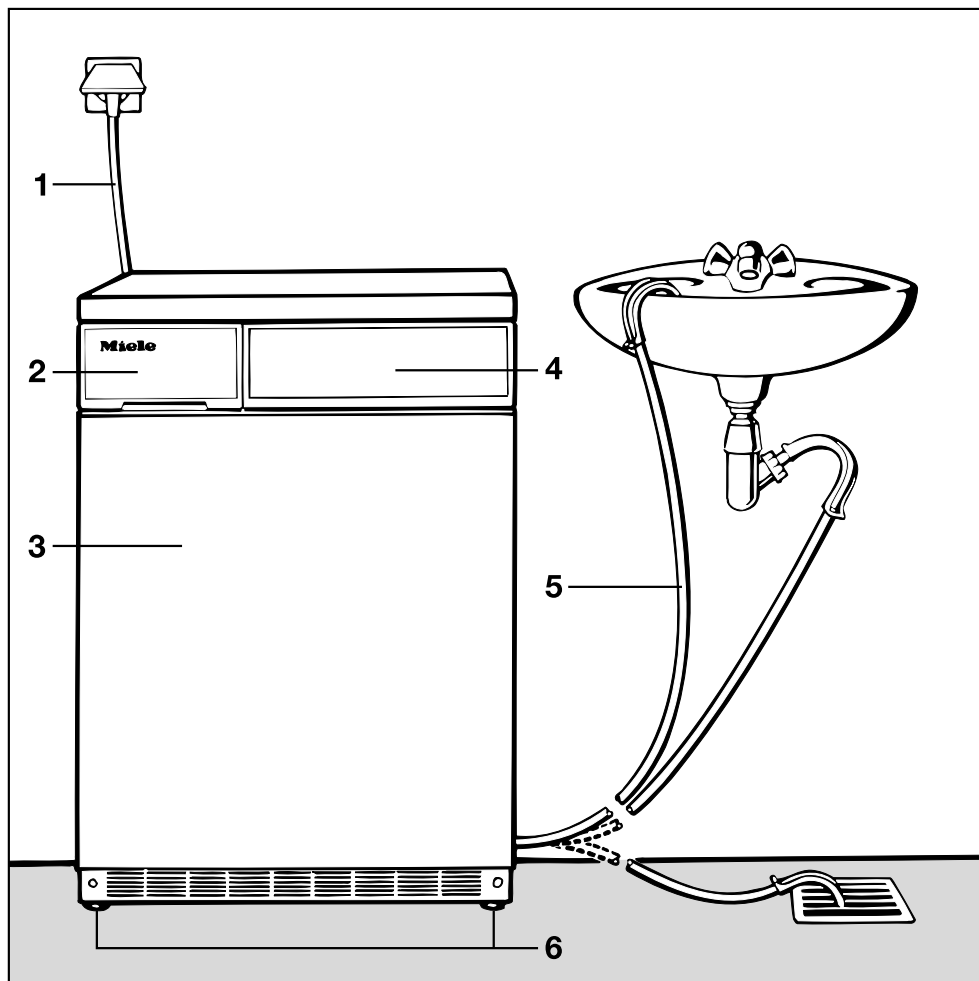

- 1 Supply cable for electrical connection
- 2 Condensed water container
- 3 Door
- 4 Control panel
- 5 Drain hose for condensed water (if fitted)
- 6 Four height-adjustable screw feet

## Control panel

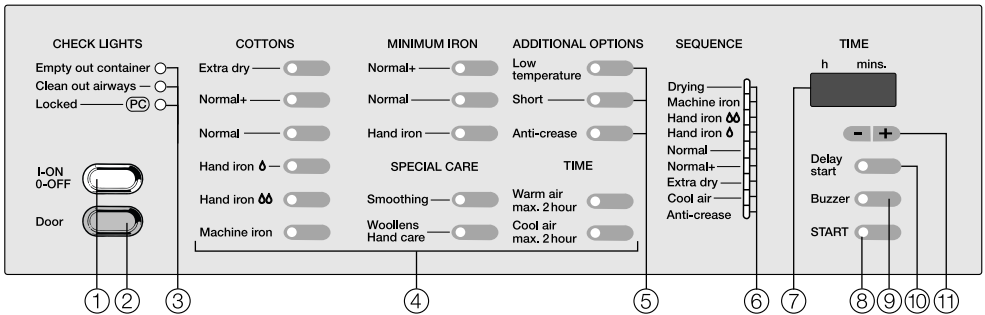

### ① “I-On/0-Off” button

to switch the appliance on and off. When the machine is switched on, the drum light will come on as you open the door.

### ② “Door” button

to open the door/cancel a programme. This button does not stay pushed in.

### ③ CHECK LIGHTS

See the section “Problem solving” for an explanation of the check lights.

### ④ Programme selector buttons

Indicator light: on= programme selected  
off= programme not selected

### ⑤ ADDITIONAL OPTION buttons

Indicator light: on= option selected  
off= option not selected

### ⑥ SEQUENCE indicator lights

show the stage the drying programme has reached.

### ⑦ Display

performs several functions:

- shows how long the programme still has to run;
- shows the time set for the programme to begin when using the “Delay start” option;
- shows the programmable functions called up.

### ⑧ “START” button

starts a drying programme. The indicator light:

- flashes to indicate that the programme can be started;
- remains on once the programme has commenced.

### ⑨ “Buzzer” button

### ⑩ “Delay start” button

The start of the programme can be delayed for up to 24 hours.

### ⑪ buttons

for keying in:

- the time for the Delay start option
- the programme length for timed drying

# Caring for the environment

---

## **Disposal of packing**

The transport and protective packing has been selected from materials which are environmentally friendly for disposal and can normally be recycled. Rather than just throwing these materials away, please ensure they are offered for recycling.

## **Disposal of your old machine/appliance**

Old machines/appliances contain materials which can be recycled. Please contact your dealer, your local waste collection centre or scrap merchant about potential recycling schemes. Ensure that the machine/appliance presents no danger to children while being stored for disposal. See the appropriate advice in the “Warning and safety” instructions.

# Warning and safety instructions

---

Please read the operating instructions before using the tumble dryer for the first time. They contain important information about the safety, use and maintenance of the machine. This will avoid the risk of accidents and damage to the machine. Keep these operating instructions in a safe place and ensure that new users are familiar with the content. Pass them on to any future owners of the machine.

## Correct usage

The tumble dryer is only intended for drying fabrics which have been washed in a water solution and are marked on the manufacturer's wash care label as being suitable for tumble drying.

Any other applications may be dangerous. The manufacturer is not liable for damage resulting from improper use or operation.

Do not let small children play with the machine and its controls or operate it. Please supervise its use by the elderly or infirm.

## Technical safety

Check for visible external damage before installation.

Do not install or operate a damaged machine or appliance.

Before connecting the machine, ensure that the connection data on the data plate (fusing, voltage and frequency) matches the mains electricity supply. If in any doubt, consult a qualified electrician.

The electrical safety of this machine can only be guaranteed when continuity is complete between the appliance and an effective earthing system which complies with local and national regulations. It is most important that this basic safety requirement is regularly tested by a qualified electrician. The manufacturer cannot be held responsible for the consequences of an inadequate earthing system.

The machine is built in accordance with current safety requirements. Unauthorised repairs could result in unforeseen dangers for the user, for which the manufacturer cannot accept responsibility. Repairs should only be undertaken by a Miele approved engineer.

In the event of a fault, or for cleaning purposes, the machine is only completely isolated from the electricity supply when:

- the plug is withdrawn, or
- it is switched off at the mains, or
- the mains fuse is withdrawn.

# Warning and safety instructions

---

■ For safety reasons, do not use an extension cable. There is a danger of overheating.

■ Faulty components must only be exchanged for Miele original spare parts. Only when these parts are fitted can the safety standards of the machine be guaranteed.

## Use

■ Do not install the machine in a room where the temperature may drop below freezing, as temperatures below zero could damage the machine.

Frozen condensed water in the pump, hose and condensed water container could also lead to damage.

■ If the water is drained externally through the drain hose instead of being collected in the condensed water container, make sure the drain hose is securely attached if you hang it in a sink or basin to avoid the hose slipping and the water causing damage.

■ Condensed water is not drinking water. It can cause health problems in people and animals.

■ Always close the door after use to avoid the danger of:

- someone leaning on the door which could cause the machine to tip;
- children climbing into the machine or hiding objects in it.

■ There is a danger of fire with fabrics which:

- contain rubber, foam rubber or rubber-like materials;
- have been treated with inflammable cleaning agents;
- have been splashed with hair lacquer, hair spray, nail varnish remover or similar;
- also padded items (eg cushions, jackets) which have been damaged, as the padding could fall out and catch fire.



## Using accessories

■ Accessory parts may only be fitted when expressly approved by Miele. If other parts are used, guarantee, performance and product liability claims may be invalidated.

## Disposing of your old machine

■ Before discarding an old machine, unplug it and render the plug useless. Cut off the cable directly behind the appliance to prevent misuse.

■ In countries where there are areas which may be subject to infestation by cockroaches or other vermin, pay particular attention to keeping the appliance and its surroundings in a clean condition at all times. Any damage which may be caused by cockroaches or other vermin will not be covered by the appliance guarantee.

# Brief instructions

---

## Brief description

When the machine is switched on, the indicator lights for all programmes will come on. **Programmes** are selected by pressing the appropriate button and can be supplemented by pressing the **additional option** buttons. The **indicator lights** show which programmes/options have been selected and the lights for the other programmes will go out.

Press the “START” button to **begin the programme**.

The **sequence indicator lights** show which stage has been reached in the drying programme.

The **Sensitive system** automatically adjusts drying to suit the water quality and ensure more precise results.

The **Novotronic controls** measure and register the conductivity of the water and compensate for variations to achieve a uniform residual moisture level.

The **automatic reversing action** turns the drum clockwise and anti-clockwise to loosen the laundry and prevent uneven drying, ensuring good results.

Once the required degree of dryness is achieved, the laundry is allowed to cool down.

At the end of the programme the **anti-crease action** period begins. The drum turns intermittently to reduce the formation of creases and folds.

**Programmable functions** can be used to select or de-select some of the additional options and introduce further functions. These combinations can be



stored in the machine's memory and called up.

Please read the sections on “Warning and safety” and “Notes on laundry care”.



## ① Switching the machine on and loading the laundry

- Switch on by pressing the “I-On/0-Off” button.
- Press the “Door” button to open the door.
- Place the laundry loosely in the drum.
- Swing the door shut but do not slam it. Do not push on the door to shut it.

## ② Selecting a programme

- Press the appropriate touch pad to select a programme.
- If selecting a timed drying programme, use the   buttons to enter the drying time.

## ③ Selecting additional options





- Press the buttons to switch additional options on or off as required.
- If required, press the “Delay start” button and enter the number of hours using the   buttons.

## ④ Starting the programme

- Press the “START” button.

Before drying, check the drying symbol on the textile care label.

Significance of symbols:

-  = Dry at normal temperature
-  = Dry at low temperature  
(also push in the "Low temperature" button if required)
-  = Do not tumble dry
-  = Can be tumble dried

If no symbol is featured, dry at your own risk applying the following principles:

Cotton and minimum iron items should be dried in the appropriate programme (see programme charts).

For delicate fabrics, eg acrylic, select "Minimum iron" and also press the "Low temperature" button.

## **The following fabrics should not be dried in a tumble dryer:**

- **Woollens and wool blends**  
These fabrics tend to become matted and shrink. These fabrics can, however, be partially dried using the "Woollens hand care" programme.
- **Down-filled items\***  
The fine fabric interior tends to shrink, depending on the quality.
- **Pure linen\***  
These items should only be machine dried if specified as suitable by the manufacturer on the textile care label, as the surface of the fabric may otherwise "roughen".  
\* Linen and down-filled items can, however, be partially dried using the "Smoothing" programme.

## **Notes:**

Some woven and loopknit materials (eg T-shirts, cotton jersey material) have a tendency to shrink, depending on their quality, and this is often made worse by over-drying. When purchasing woven materials, it is advisable to take their shrinkage properties into account.

Starched washing can be dried in the tumble dryer. In order to achieve the usual finish, double the amount of starch should be used.

Minimum iron shirts or blouses in 100% cotton may crease badly, depending on the quality and weave. Try drying these items using the "Hand iron" setting but if this is unsatisfactory use the "Smoothing" setting, then hang the garments on a hanger to dry.

Minimum iron fabrics tend to crease more, the larger the drying load, particularly when the weave of the fabric is very fine. The load should be reduced to 1.5 kg or, if necessary, to 1 kg.

New dark-coloured fabrics should be dried separately from light-coloured fabrics to avoid colours running.

# How to dry correctly

## Hints on saving energy

- Make sure that your laundry has been thoroughly spun at the highest appropriate spin speed before drying. Spinning at 1600 rpm, for example, saves approximately 30% energy and time compared with 800 rpm.
- Load the full amount of laundry according to the programme chosen (see “Programme chart”) for the most economical drying related to the size of the load. Make sure that the drum is not over- or under-loaded.
- As far as possible, sort fabrics for:
  - the type of fibre or weave
  - the degree of drying required
  - similar size of items
  - the moisture content after spinning.This will help towards an even drying result.
- Ensure the room is well ventilated.

## ① Switching on and loading

- Fasten duvet covers etc to prevent small items from being rolled up inside them.
- Do up zips and tie fabric belts and apron strings.
- Press the “I-On / 0-Off” button.
- Press the “Door” button and open the door.

Make sure there is no washing detergent dispenser among the laundry, as this could melt and damage the machine and the laundry.

- Load the laundry very loosely into the drum.

Do not overload the drum. Overloading can cause unnecessary wear and tear to the laundry and give a disappointing drying result.

- Shut the door with a light swing but do not slam it. Do not push on the door to shut it.

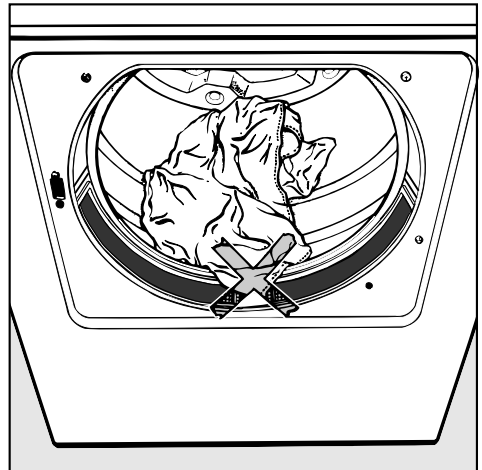

Important: Please check that items of laundry cannot be trapped by the door, as this will cause damage to the fabric.

## 2 Selecting a programme

See the “Programme chart” for a description of each programme.

### COTTONS; MINIMUM IRON; SPECIAL CARE

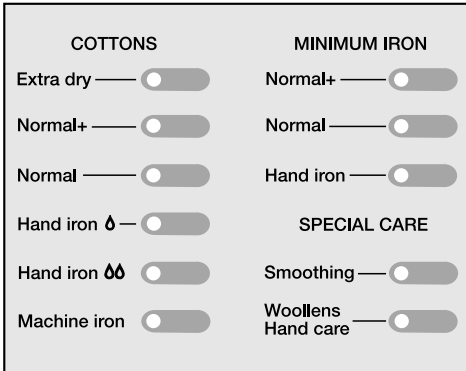

- Press the touch pad for the required programme.

The length of the programme is determined by the electronics according to each load.

## TIMED DRYING

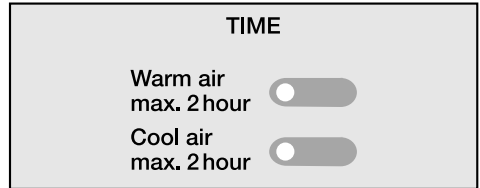

- Press the touch pad for the required programme:  
the programme length chosen when the programme was last used will appear in the display.

To alter the programme length

- Press the  $\boxplus$  touch pad repeatedly until the correct length of time appears in the display.

Times from **15** minutes up to **30** minutes are chosen in 5 minute stages

Times from **30** minutes up to **2** hours are selected in 10 minute stages.

- To reduce the length of the programme press the  $\boxminus$  button.

### Note

The indicator lights show which programmes and additional options have been selected.

# How to dry correctly

---

## ③ Selecting additional options

- One or more additional options can now be switched on or off.
- If required, the delay start option can be selected.

See the “Additional options” and “Delay start” sections for further information.

## ④ Starting a programme

- Press the “START” touch pad.

The drying stage reached display will indicate which drying stage the programme has reached.

### The memory function:

If the memory function has been activated, the machine will automatically call up the additional options selected for the previous programme. The indicator lights will indicate which options are selected and, if using timed drying, the programme length selected last time will appear in the display. For further details on the memory function, please see the section “Programmable functions”.

### "Clean out airways" indicator light

This indicator light shows that the dryer is not working most efficiently or economically.

The causes of this check message can be:

- the fluff filters in the door and the door opening are blocked;
- the condenser unit is blocked.

## After drying

When the drying programme has finished the “Anti-crease” sequence indicator light comes on.

- Press the “Door” button to open the door.
- Remove the laundry.
- Make sure that the drum is empty.

If items are left in the dryer, they could be damaged by overdrying when the dryer is next used.

- After every cycle remove the fluff from
  - the fluff filter in the door
  - the filters in the door opening (See the section on “Cleaning and care”).
- Empty the condensed water container (where there is no external drainage of the water). See the section on “Cleaning and care”.

Close the door and switch off the machine after each use.

- Press the “I-On / 0-Off” button to switch off.

- Additional options can be switched on or off by pressing the relevant button before the start of a programme.

Indicator lights:

- **on**= additional option switched on
- **off**= additional option switched off

It is not possible to activate additional options which are incompatible with the basic drying programme selected. The indicator light will go out when the option button is released.

If an inappropriate combination of options is selected (eg “Short” and “Low temperature”) only the option that was selected last will be activated.

## Anti-crease

Once a programme has ended the drum will turn at regular intervals to prevent the laundry from settling into creases and folds.

## Short

The programme running time is reduced.

- For drying fabrics that are not delicate.

## Low temperature

The drying temperature is reduced.

- For delicate fabrics (drying symbol ) , eg acrylic.

The programme running time is increased.

## Buzzer

An audible tone sounds repeatedly at the end of a programme during the Anti-crease phase.

The volume of the buzzer can be adjusted:

- ① Select the programme.
- ② Press the “Buzzer” button (the “Buzzer” indicator light will come on) until the desired volume is achieved. The pitch of the buzzer will rise at the same time.
- ③ Release the “Buzzer” button and start the programme.

# Programme chart

Programme	Fabric type	maximum load <sup>(2)</sup>	Special notes
-----------	-------------	-----------------------------	---------------

COTTONS			
<b>Extra dry</b>	Multi-layered fabrics, not thoroughly dried with "Normal +"	5 kg	Do not dry jersey wear in the Extra dry programme – tendency to shrink.
<b>Normal +</b>	Mixed load of cotton fabrics, eg towelling, jerseywear, ie single and multi-layered fabrics	5 kg	–
<b>Normal <sup>(1)</sup></b>	Load of similar fabrics (jersey wear, flannelette sheets, towelling).	5 kg	If fabrics are too damp, select "Normal +".
<b>Hand iron Δ</b>	Cotton or linen fabrics (eg table linen, bedlinen, starched laundry etc)	5 kg	–
<b>Hand iron ΔΔ <sup>(1)</sup></b>		5 kg	If fabrics are too damp to hand iron, select Hand iron Δ.
<b>Machine iron</b>	Cotton or linen fabrics, including starched laundry, for machine ironing	5 kg	The laundry should be rolled up to prevent it from drying out until it can be ironed.

<sup>(1)</sup> Note for Test Institutes: These are the programmes that should be tested according to the EN 61121/A11 Standard.

<sup>(2)</sup> Weight of laundry when dry



# Programme chart

Programme	Fabric type	Maximum load <sup>(2)</sup>	Special notes
-----------	-------------	-----------------------------	---------------

## MINIMUM IRON

<b>Normal+</b>	Minimum iron items which are made of synthetics or blended fabrics, (eg pullovers, dresses, trousers) which are not dried adequately in the "Normal" programme	2.5 kg	Spin minimum iron fabrics for at least 30 seconds in the washing machine before drying
<b>Normal</b> <sup>(1)</sup>	Minimum iron shirts, Table cloths etc made of blended fabrics, (eg cotton/synthetics) .	2.5 kg	
<b>Hand iron</b>	Minimum iron shirts, Table cloths etc made of blended fabrics, (eg cottons and synthetics), which are still to be hand ironed	2.5 kg	

## TIMED DRYING

<b>Warm air</b>	Individual items, (eg bathing costumes, bath towels, tea towels)  Multi-layered fabrics whose layers have different drying characteristics	5 kg	–
<b>Cool air</b>	Items which are only to be aired	5 kg	–

## Special care programmes

<b>Woollens hand care</b>	Woollen fabrics	1 kg	To refresh and fluff up woollen garments quickly. Remove garments immediately at the end of the programme. Do not repeat. Woollen fabrics are not dried completely by this programme.
<b>Smoothing</b>	Minimum iron items made of cotton, blended fabrics or synthetics	2.5 kg	Smooths out creases resulting from the spin cycle in the washing machine. Remove garments immediately at the end of the programme

<sup>(1)</sup> Note for Test Institutes: These are the programmes to be used when testing according to the EN 61121/A11 Standard

<sup>(2)</sup> Weight of the washing when dry

# Display

---

Various pieces of information are shown in the display:

- the length of time a programme still has to run (time left);
- the length of programme selected for timed drying;
- the number of hours selected for the delay start option;
- programmable functions as they are switched on or off.

Each load should ideally be made up of items of the same size. The time left will vary more if items are of very different sizes. In this case the time may stop counting down shortly before the end of the programme, (see the "Problem solving guide").

## Time left indicator

Once a programme has started, the electronics calculate how long the programme will last and the following symbols: `=== ... -== ...` appear in the display. After approximately a minute the length of the programme will appear and a countdown in minutes will commence.

The time left can vary with each programme because it is dependent on several factors:

- the quantity, type and residual moisture of the various items in the load;
- variations in electrical current;
- the surrounding temperature.

The time left should therefore only be regarded as an estimate. However, to make this estimate as precise as possible, the machine has intelligent electronics that are capable of "learning". During the first 10-15 programmes run in the machine, the electronics will monitor your individual laundry items and adapt accordingly.

Once a programme has been selected, the start can be delayed from 30 minutes (30) up to 24 hours (24h).

- Select a programme.

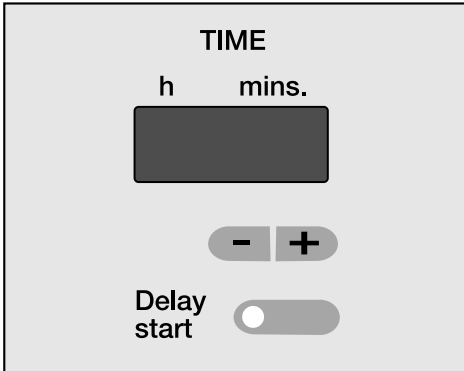

- Press the "Delay start" button.
- Press the (+) button repeatedly until the required time appears in the display:
  - up to 10h in 30 minute stages;
  - from 10h to 24h in 1 hour stages.
- To reduce the length of time, press the (-) button.
- Press the "START" button.

The chosen time will be counted down:

- from 24h to 10h in 1 hour stages;
- less than 10h in 1 minute stages.

Approximately 1 minute after the programme starts the time left will appear in the display.

## To cancel delayed start

- Press the "Delay start" button; or, if the "START" button has already been pressed:
  - switch the machine off using the "I-On/O-Off" button.

# Altering a programme

---

Once a programme has started, no changes to the programme or additional options will be accepted.

## To cancel a programme

- Open the door or switch the machine off.

## To select a different programme

- Turn the machine off and on again.
- Select the required programme by pressing the appropriate button.
- Select the additional options required.
- Press the “START” button.

## To open the door during a programme to add or remove garments

### Cancel the programme by:

- Pressing the “Door” button and opening the door.
- Items can now be added or removed early.

### Restart the programme by:

- Closing the door.
- Selecting the programme.
- Selecting the additional options.
- Pressing the “START” button.
- The programme will restart.
- The time left shown in the display may now vary from the actual drying time.

If there is a power cut, TIMED DRYING programmes have to be restarted once the power supply is restored.

The system lock prevents anyone from interfering with the dryer.

## To activate the system lock

- ❶ Close the door.
- ❷ Turn the machine on.
- ❸ Press the “Short” button and keep it pressed in while carrying out steps ❹ to ❷.
- ❹ Press the “Machine iron” button.
- ❺ Release the “Machine iron” button.
- ❻ Press the “MINIMUM IRON, normal” button.
- ❼ Release the “MINIMUM IRON, normal” button.
- ❽ Release the “Short” button.

The “Locked” indicator light will flash.

- ❾ Switch the machine off.

## To de-activate the system lock

- Repeat steps ❶-❽.

The “Locked” indicator light will go out after step ❽.

# Programmable functions

---

## Notes

The programmable functions can be used to create drying programmes to suit your individual requirements. They will remain in the machine's memory until cancelled.

- One or all of the programmable functions can be activated or cancelled. (See following page).

## Programmable function 01: "Correcting the drying level"

The Sensitive System aims to dry using as little energy as possible. However, if you require the washing to be drier, it is possible to reduce the final moisture level on all programmes.

The machine is delivered with this function switched off.

## Programmable function 03: "Memory"

The additional options chosen for the last drying programme are stored in the machine's memory.

The memory programmable function can be used to switch the memory on or off. The machine is delivered with the memory function activated.

## Activating and storing in the memory

The programmable functions are activated using the additional option buttons in special combinations with the programme selector buttons to introduce extra features not marked up on the control panel.

- ❶ Switch the machine off and shut the door.
  - ❷ Press the “COTTONS, extra dry” and the “MINIMUM IRON, normal+” touch pads. Keep them pressed in and ...
  - ❸ ... switch the machine on by pressing the “I-On/0-Off” touch pad.
  - ❹ Release all the buttons.
- *P* will appear in the display.
- ❺ Press the **+** button to select the programmable functions as follows:

Press **+** once =  
programmable function *01*  
("Correcting the drying level")

or

press **+** twice =  
programmable function *03*  
("Memory function")

- Use the **-** button to go back a step if necessary.

- ❻ The number of the programmable function will flash in the display, alternating with the *P*.

Example:

*010... P 0... 010... P 0... .*

The number on the right will show constantly and means:

*0* = Programmable function off

*1* = Programmable function on

- ❼ Press the “START” touch pad to change the number on the right from *0* to *1* = on or from *1* to *0* = off.
- ❽ If you wish to activate a further programmable function, repeat from step ❺. If not:
- ❾ To store in the memory: Press the “Buzzer” button.  
Switch the machine off by pressing the “I-On/0-Off” button.

## To de-select a programmable function

- Carry out steps ❶ to ❾.

## To check whether a programmable function is activated:

- Carry out steps ❶ to ❾.
- Switch the machine off.

This completes the check.

# Cleaning and care

## Cleaning the fluff filters

The fluff which is created by the drying process is collected in the fluff filters in the door and door opening.

- Clean the filters after every programme to reduce drying time and save energy.

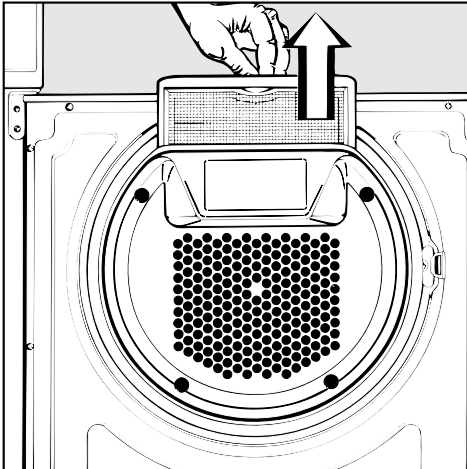

- Open the door. Grip the filter by the recessed handle and pull upwards to remove.
- Remove the fluff from:
  - the filter in the door
  - the filters in the door opening**Do not use any sharp or pointed objects.**
- Remove any fluff from the hollow part of the door holder through the wide slit at the bottom. A cleaning brush is available at extra cost from the Miele Spare Parts Department.
- Push the cleaned filter back into the door holder and close the door.

If there is a great deal of compacted fluff on the filters, they can be cleaned under hot running water.

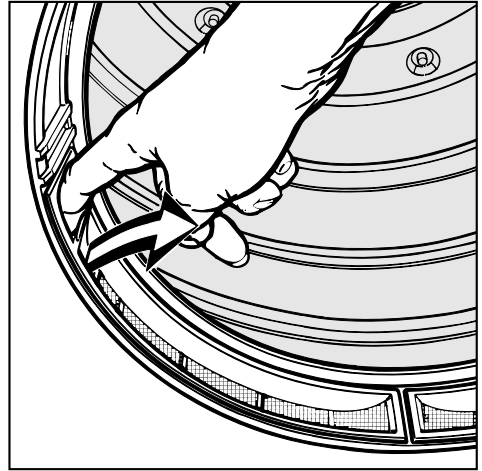

- These filters should only be removed for cleaning with water.
- Dry the filters well after rinsing and put back in place.

## Cleaning the tumble dryer

Disconnect the machine from the power supply.

- Clean . . .
  - . . . **the housing and control panel:** with a mild detergent or soapy water;
  - . . . **the drum and other stainless steel parts:** with a suitable proprietary stainless steel cleaner following the manufacturer's instructions.

Never use abrasive substances, scouring pads, glass or general purpose cleaners. These could damage plastic surfaces and other parts. The machine must never be hosed down.

- Dry all parts with a soft cloth.



## Emptying the condensed water container

If the hose drain has not been fitted and connected, the condensed water will be collected in the condensed water container.

The condensed water container should be emptied after every drying cycle, or as soon as the "Empty out container" indicator light comes on.

If . . .

. . . the condensed water container is full when a programme is started or . . . it becomes full during a drying cycle:

- the "Empty out container" light will come on,
- the buzzer will sound,
- the programme will be stopped,
- the washing will be cooled down and the "Cool air" light will come on.

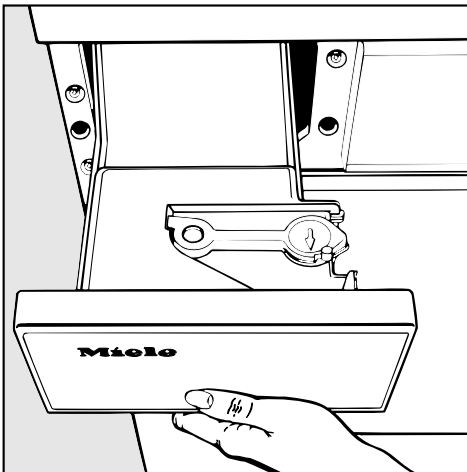

- Pull the container out of the machine, gripping it firmly with both hands.

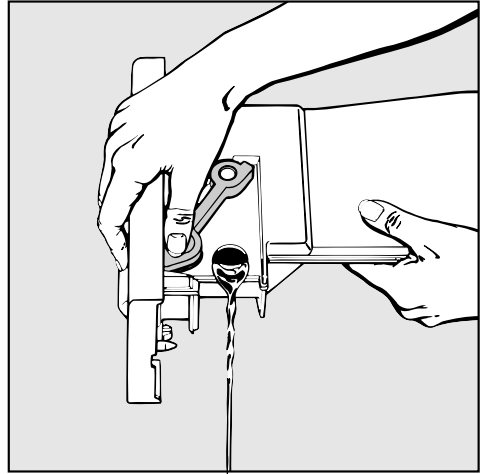

- Slide back the cap and pour the water away.
- Push the container back into the machine until it engages into place.

Condensed water should not be drunk. It could lead to health problems for humans and animals.

Condensed water can be put to household use, eg used in a steam iron or humidifier.

### Note:

- To ensure that no particles of fluff are left which could damage the appliance, pass the condensed water through a fine sieve or paper filter.

# Cleaning and care

## Cleaning the condenser unit

The machine must be disconnected from the electricity supply before cleaning.

- The condenser unit should be cleaned at least four times a year.

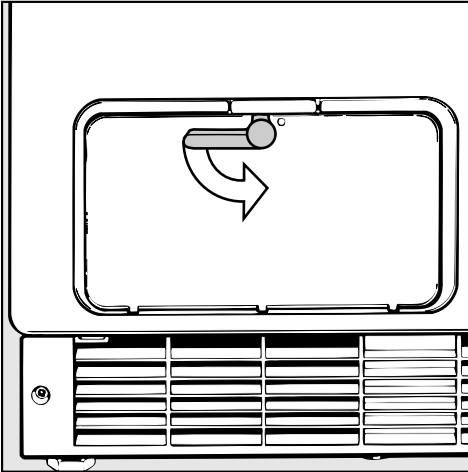

- Open the door.
- Turn the cover lock downwards to the vertical position.

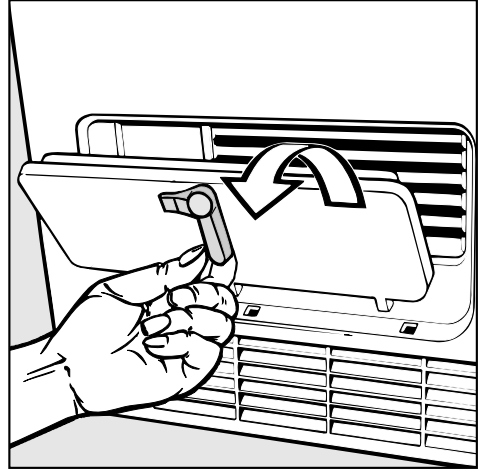

- Pull the cover off.

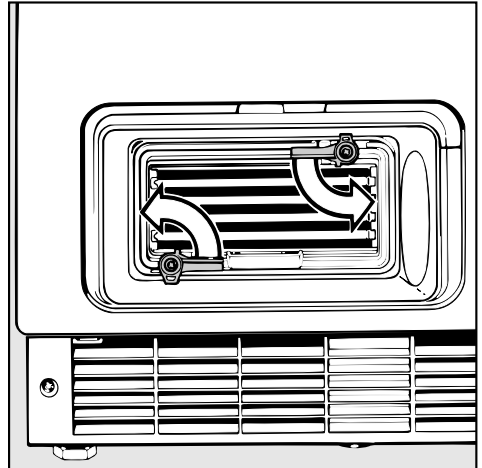

- Turn both levers on the condenser unit to the vertical position.

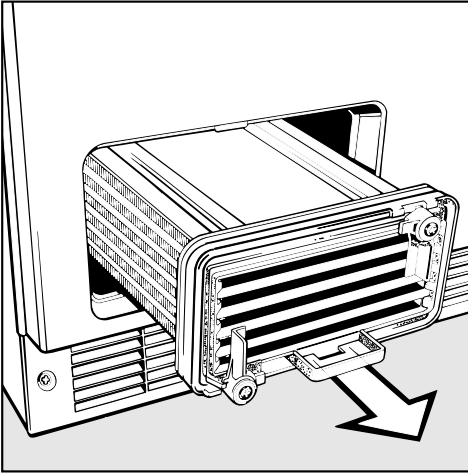

- Pull the condenser unit out.

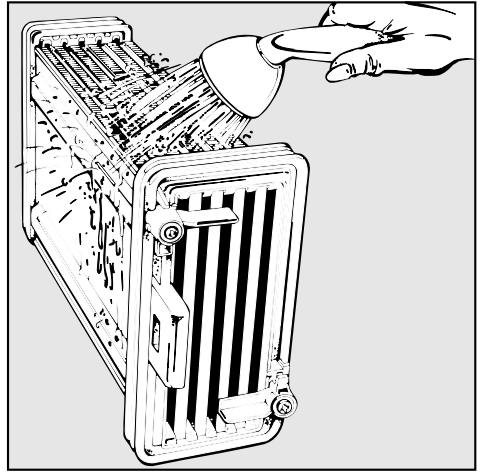

- Clean the two long sides of the unit.
- Stand the condenser unit lengthwise on a towel until it is quite dry.
- Replace the condenser unit (see illustration above left).
- Return both levers on the condenser unit to the horizontal position. Pull forwards on the unit to check that it is firmly in place.
- Replace the cover and check that it is also firmly in place, otherwise water may leak from the machine.
- Close the door.

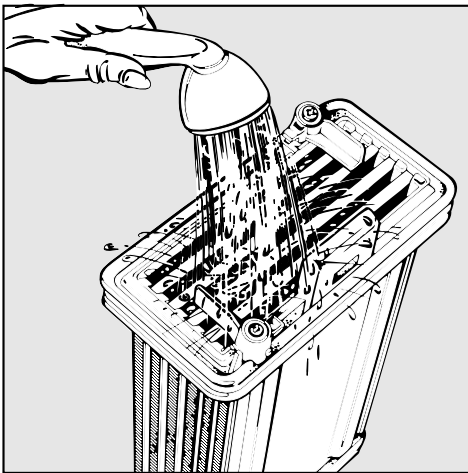

- Clean the condenser unit at both ends (front and back).

Wipe the rubber seals at both ends gently but thoroughly.

# Problem solving guide

## What to do if ...

Electrical appliances should only be repaired by qualified personnel. Incorrectly repaired machines may pose a considerable risk to the user.

What to do if ...	Cause ...	Remedy ...
... the tumble dryer fails to start when switched on	This may be due to an incorrect selection procedure sequence when switching on the machine.	Repeat the switch-on procedure (see section on "Drying correctly"). Also check the following: <ul style="list-style-type: none"> <li>– Is the machine plugged in at the mains switch?</li> <li>– Is the door closed properly?</li> <li>– Was the "I-On/0-Off" button pushed in?</li> <li>– Was the "START" button pushed in?</li> <li>– Has the delay start been activated? The programme will start once the time delay has expired.</li> <li>– Has the fuse or circuit breaker tripped? If so, contact the Miele Service Department.</li> </ul>
... items made of synthetic fibres are charged with static electricity after drying		Static charge can be reduced by adding a fabric conditioner for the final rinse in the washing machine.
... the laundry is not sufficiently dry	The load consists of different fabrics.	Select a more suitable drying programme next time.
... there is a build-up of fluff	Fluff is principally the result of friction when garments are being worn and washed. Machine drying hardly causes any fluff to form and, as has been established by research institutes, has no effect on the lifetime of fabric.	

# Problem solving guide

What to do if . . .	Cause . . .	Remedy . . .
<b>. . . the drying process goes on too long.</b>	Ventilation to and from the dryer is insufficient (eg in a small room). This could cause the room temperature to rise sharply.	Open a door or window while the machine is in operation for increased air flow.
	The vent below the door is blocked.	Remove any objects that are blocking the vent below the door.
	The dryer cannot blow air out correctly.	<ul style="list-style-type: none"> <li>– Clean the fluff filters in the door and the door opening.</li> <li>– Clean the condenser unit.</li> </ul>
	The laundry was not sufficiently spun.	Spin the laundry in the washing machine at the highest possible spin speed.
<b>. . . water droplets appear at the upper edge of the drum aperture.</b>	A double filter system with dual insulation prevents fluff from being deposited in the condenser unit. This insulation can lead to a build-up of condensation.	Laundry being removed from the machine may come into contact with these water droplets, but they will dry off in a matter of minutes.
<b>. . . water leaks from the machine after the condenser unit has been cleaned.</b>	The condenser unit has not been correctly locked into place.	Ensure that the condenser unit and cover are firmly in position and lock into place again.
<b>. . . the interior drum lighting does not come on.</b>	It only lights up when the machine is switched on. The bulb may be defective.	Change the bulb. See instructions at the end of this section.
<b>. . . you need to open the door during a power cut.</b>		See instructions at the end of this section.

# Problem solving guide

<b>Check and indicator lights and display messages:</b>		
<b>What to do if . . .</b>	<b>Cause . . .</b>	<b>Remedy . . .</b>
<b>. . . the “Locked” indicator light flashes when the machine is switched on.</b>	The system lock is activated. The programme cannot be started.	See section “Electronic system lock”.
<b>. . . the “Locked” indicator light comes on during drying.</b>	That is not a fault.	The light will go out at the end of the programme.
<b>. . . the “Anti-crease” indicator light flashes.</b>	Cold surrounding temperatures below freezing are affecting the machine (frozen condensed water).	Install the appliance in a warmer room. If the indicator light continues to flash there is a technical problem. Contact the Miele Service Department.
<b>. . . the “Empty out container” light comes on.</b>	The condensed water container is full.	Empty the container. Check that the condensed water container is correctly positioned.
<b>. . . the “Clean out airways” light comes on.</b>	The fluff filters or the condenser unit are blocked.	– When the programme has ended, clean the filters (see section “Cleaning and care”). – Clean the condenser unit and check that it is correctly positioned.
	The electronics are registering that the machine is underloaded.	Always load the machine to full capacity for economical drying.
<b>. . . once the programme has started the following symbols appear in the display: “=== ... -== ...”</b>	This is not a fault.	See the “Display” section.
<b>. . . the programme is interrupted, the “Anti-crease” indicator light comes on and <math>\emptyset</math> appears in the display.</b>	If there is no laundry in the drum when the programme is started, the electronics will register this and stop the programme. The programme will also be interrupted if the laundry placed in the drum is already dry.	
<b>. . . the programme is interrupted and “-” appears in the display.</b>	See the section on “What to do if the drying process goes on too long”.	
<b>. . . shortly before the end of the programme the count down of the time left to run halts at “10”, but the dryer continues to dry.</b>	This is not a fault. One of the pieces being dried is considerably larger than items that have been dried in previous programmes. The time left may vary from that calculated by the machine for a normal load.	The drying process is not yet complete. The programme needs more time than the electronic unit had calculated at the start of the programme. The time count down is suspended until the degree of drying selected has been reached.

## The interior drum lighting does not come on: changing the bulb

- Open the door.

Before changing the bulb, disconnect the machine from the mains power supply.

The cover must be fixed securely otherwise moisture may seep in and cause a short circuit.

The temperature resistant bulb should only be ordered from your Miele dealer or the Miele Spare Parts Department.

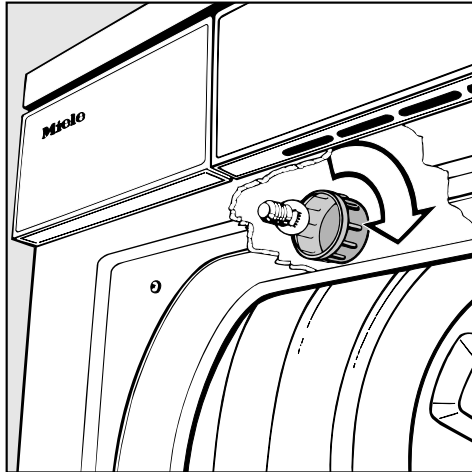

- Unscrew the plastic cover above the door inside the drum.
- Replace the bulb.

The light bulb must not exceed the maximum wattage quoted on the data plate and the light cover.

- Replace the plastic cover and screw back on.

## Opening the door in the event of a power failure.

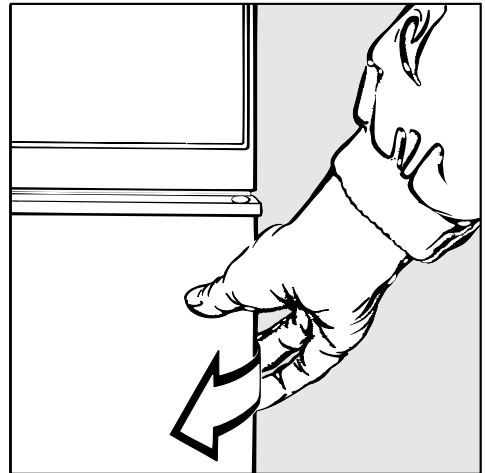

# After sales service

---

## Repairs

In the event of any fault which you cannot remedy yourself, please contact:

- your Miele dealer
- or
- your nearest Miele Service Department (see back cover for the address).

When contacting the Service Department, please quote the model and serial numbers of your appliance, both of which are shown on the data plate which is located beneath the drum opening on the right.

## Future updates

The indicator or check light marked PC allows a service engineer to update your machine in future years.

When, for example, new programmes are developed or new fabrics are introduced, a service engineer will be able to modify existing programme cycles accordingly.

Miele will provide information when such possibilities become available.

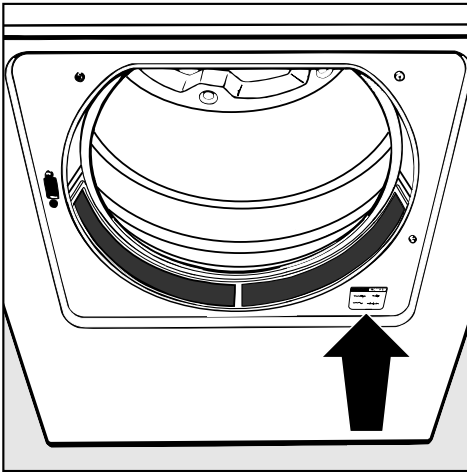



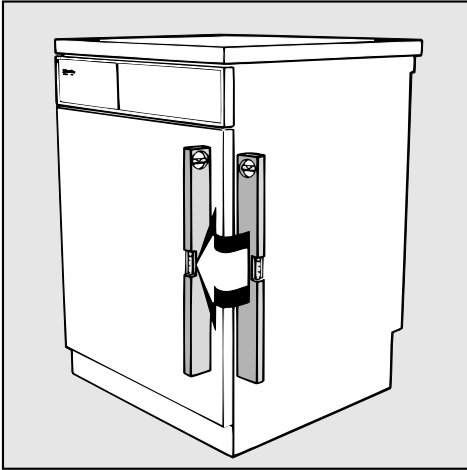

The ventilation slots beneath the door must on no account be blocked as this will prevent a sufficient intake of cold air.

## Installation

### Building under a continuous worktop/in a row of kitchen units

A special conversion kit\* is necessary.

- The machine lid is replaced by a coverplate which must be fitted by a suitable competent person to ensure electrical safety.
- When installing under a worktop with a working height of 900/910 mm, a spacer kit\* is necessary.

When built under, the running times may be longer.

The tumble dryer can also be combined with a Miele washing machine in a washer and dryer stack. For this purpose the appropriate stacking kit\* to match your washing machine is required.

\*These items are available from your Miele dealer.

(N.B. If you wish to push your machine under a worktop and there is space to do this without removing the lid, the conversion kit is not necessary. Otherwise the conversion kit is essential).

The machine must be perfectly level to ensure safe and proper operation. Minor differences do not, however, have an adverse effect on operation.

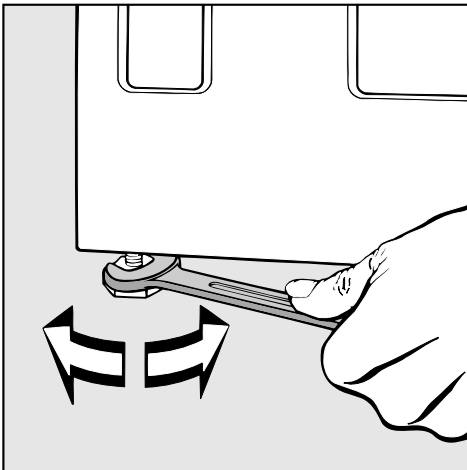

- The screw feet can be adjusted to compensate for any unevenness in the floor surface.

# Installation

## Fitting or changing the decor panel

Note: The door should be shut for fitting or changing the decor panel.

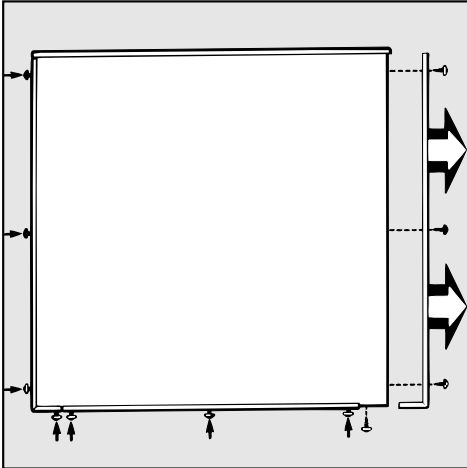

- Remove the 4 screws from the decor strip on the door catch side of the door and remove the decor strip.
- Unscrew the remaining 7 screws from the lower and side decor strip until the decor panel bows slightly and can then be taken out or put in place.
- Reassemble in the reverse order and tighten the screws.

## Decor panel dimensions

The figures given in brackets indicate the tolerance level in mm:

Width = 587 (-1) mm

Height = 602 (-1.5) mm

Thickness = 1 (+0.5) mm

Panels more than 1.5 mm thick require an "adapter strip for a 4 mm thick decor panel". This is available from your Miele Dealer or the Miele Spare Parts Department.

Note: The decor panel height required for the adapter strip must not exceed 596.5 (-1.5) mm.

## Fitting the plinth fascia

- The appliance plinth below the door can be concealed using a plinth fascia.
- The height and return of the appliance plinth cannot be altered.
- A taller plinth fascia can only be installed if the overall niche height is higher.

Plinth height	Niche height	
100 mm (standard)	820 mm	–
150 mm	870 mm	a spacer frame is required
200 mm	920 mm	2 spacer frames are required

A plinth fascia (60 cm long) can be ordered from your kitchen dealer or manufacturer.

A cut-out must be made in the plinth fascia around the ventilation slots otherwise the air flow to the appliance will be blocked and the machine will not work.

## Fitting the plinth fascia:

- Place the small template supplied on the **back** of the upper edge of the plinth fascia and fasten with sticky tape.
- Cut out the plinth fascia according to the template.
- Cover the cut surface with the strip supplied.
- Stick the velcro fastener supplied to the appliance plinth.

For this the following procedure is recommended:

- Press the two halves of the velcro fastener together lengthwise.
- Cut into 2 or 3 pieces.
- Peel off the protective backing from one half of the velcro fastener pieces.
- Stick the pieces along the appliance plinth, at the left and right hand edge and in the middle. Press firmly into place.
- Peel off the remaining protective backing strips.
- Press the plinth fascia firmly onto the sticky surface of the velcro.

# Installation

## External condensed water outlet

The condensed water can be drained off directly if the machine is installed near a sink, drain outlet etc.

Maximum drain hose length: 3.00 metres  
Maximum delivery head: 1.00 metre

### Accessories supplied:

- 2 metre drain hose
- Hose clamp
- Adapter sleeve
- Hose clip

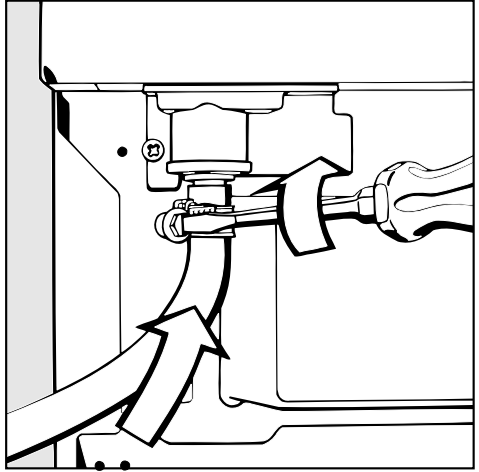

- Push the drain hose onto the drain outlet.
- Secure the hose firmly with the clip.
- Make sure that the hose is not kinked.

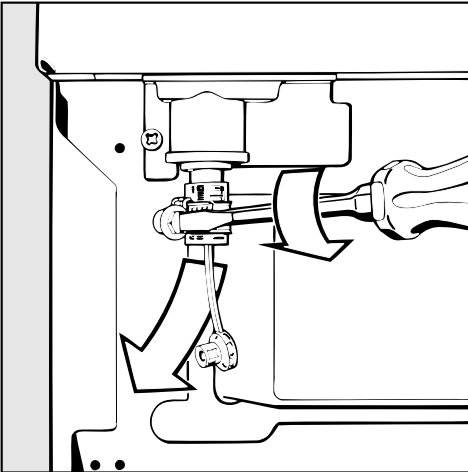

- Unscrew the hose clip from the drain outlet at the back of the machine.
- Remove the rubber plug.

The dryer is fitted with a non-return valve as standard to prevent water from flowing back into the machine.

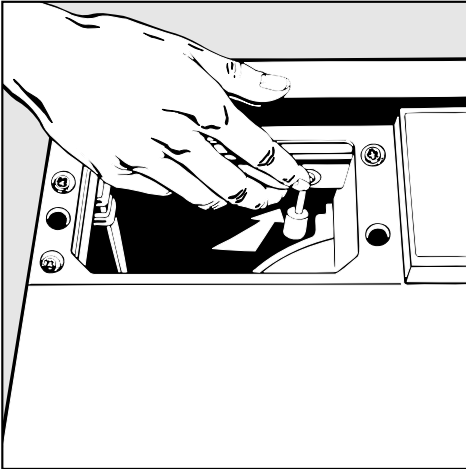

- Close the water inlet port to the condensed water container with the bottom part of the rubber plug. The plug must face towards the interior of the machine so that the condensed water container can be pushed in easily.

## Connection to wash basin drain outlet (where appropriate)

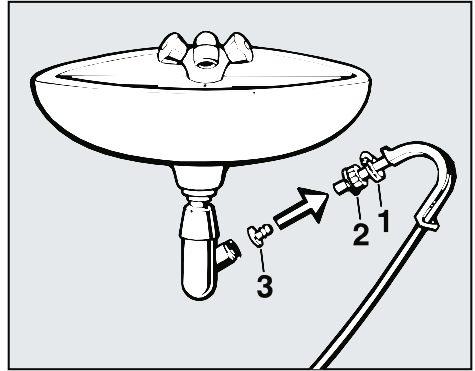

- Push the hose clip (1) and the knurled nut connector from the sink drain outlet (2) over the drain hose.
- Push the adapter sleeve (3) into the hose.
- Screw the drain hose to the drain outlet with the knurled nut connector.
- Tighten the hose clip up close to the nut.

# Electrical connection

---

## Electrical connection U.K.

All electrical work should be carried out only by a suitably competent person, in strict accordance with national and local safety regulations.

The appliance is supplied with a mains cable with moulded plug for connection to a 230-240V mains supply. The voltage, rated load and fuse rating are given on the data plate. Please ensure these match the household mains supply.

Connection should be made via a fused plug and suitable switched socket which is easily accessible after installation. For extra safety it is advisable to install a residual current device (RCD), with a trip current of 30 mA. Do not connect via an extension lead.

### Important

The wires in the mains lead are coloured in accordance with the following code:

Green/yellow	= earth
Blue	= neutral
Brown	= live

Where it is necessary to change plugs, if the colours of the wires in the mains lead of this appliance do not correspond with the coloured markings identifying the terminals of your plug, proceed as follows:

The wire which is coloured green and yellow must be connected to the terminal in the plug which is marked with the letter E or by the earth symbol  $\perp$  or coloured green, or green and yellow.

The wire which is coloured blue must be connected to the terminal in the plug which is marked with the letter N or coloured black.

The wire which is coloured brown must be connected to the terminal in the plug which is marked with the letter L or coloured red.

### **WARNING: THIS APPLIANCE MUST BE EARTHED**

Ensure power is not restored to the appliance while installation work is being carried out.

### **Non-rewireable plugs BS 1363**

If this machine is fitted with a non-rewireable plug, the following information applies:

If the socket outlets are not suitable for the plug supplied with the product, it must be cut off and an appropriate plug fitted.

The plug cut from the flexible cord should be disposed of and on no account be inserted into any socket elsewhere in the house (electric shock hazard).

The fuse cover must be refitted when changing the fuse, and if the fuse cover is lost, the plug must not be used until a suitable replacement is obtained. The colour of the correct replacement cover is that of the coloured insert in the base of the plug, or the colour that is embossed in words on the base of the plug (as applicable to the design of plug fitted).

Replacement fuses should be ASTA approved to BS 1362 and have the correct rating. Replacement fuse covers may be purchased from your local electrical supplier or Service agent.

# Consumption data

Programme	Capacity kg	Final spin speed (in a domestic washing machine) rpm	Electricity consumption kWh	Drying time incl. cooling down time Minutes	
				10 A <sup>(2)</sup>	16 A <sup>(2)</sup>
<b>COTTONS</b>					
Extra dry	5	1200	3.0	95	77
		1400	2.9	92	74
		1600	2.6	82	67
Normal +	5	1200	2.9	92	74
		1400	2.7	88	71
		1600	2.5	79	64
Normal <sup>(1)</sup>	5	800 (70 % residual moisture)	3.5	109	88
Normal	5	1200	2.8	88	71
		1400	2.6	85	68
		1600	2.3	77	62
Hand iron ∆∆ <sup>(1)</sup>	5	800 (70 % residual moisture)	2.85	91	74
Hand iron ∆∆	5	1200	2.1	66	56
		1400	1.95	66	54
		1600	1.6	56	46
Machine iron	5	1200	1.7	59	48
		1400	1.6	55	44
		1600	1.3	47	38
<b>MINIMUM IRON</b>					
Normal +	2.5	1000	1.4	55	46
Normal <sup>(1)</sup>	2.5	1000 (50 % residual moisture)	1.3	52	44
Hand iron	2.5	1000	1.1	47	39
<b>Special care</b>					
Woollens, Hand care	1	–	0.2	3	3
Smoothing	2.5	–	0.3	8	8

<sup>(1)</sup> Test performance in accordance with EN 61121/A11.

<sup>(2)</sup> Drying times may vary slightly. For fuse rating see data plate.

All values obtained in accordance with standard test EN 61121/A11.

Different types of fabric, the load and residual moisture after spinning may affect the figures given.

## Technical data

---

Height . . . . .	850 mm (adjustable +10/-5 mm)
Width . . . . .	595 mm
Depth . . . . .	600 mm (incl. distance from wall)
Weight . . . . .	57 kg
Drum volume . . . . .	103 l
Maximum capacity . . . . .	5 kg dry weight

Capacity of condensed water container . . . . .	approx 4 l
Maximum delivery head . . . . .	1 m
Maximum drain hose length . . . . .	3 m

Voltage . . . . .	} see data plate
Rated load . . . . .	
Fuse rating . . . . .	

Electricity consumption . . . . .	see section "Consumption data"
Test certificates awarded . . . . .	Radio/TV suppressed, VDE









# Miele

## **United Kingdom**

Miele Co. Ltd.

Fairacres, Marcham Road, Abingdon, Oxon, OX14 1TW

tel. Abingdon (01235) 554455 - fax (01235) 554477

Service Office, tel. Abingdon (01235) 554466

## **Ireland:**

Miele Ireland Ltd.

Wilton House, Naas Road, Dublin 22

Tel. (01) 4504024, Fax (01) 4504037

## Free Manuals Download Website

<http://myh66.com>

<http://usermanuals.us>

<http://www.somanuals.com>

<http://www.4manuals.cc>

<http://www.manual-lib.com>

<http://www.404manual.com>

<http://www.luxmanual.com>

<http://aubethermostatmanual.com>

Golf course search by state

<http://golfingnear.com>

Email search by domain

<http://emailbydomain.com>

Auto manuals search

<http://auto.somanuals.com>

TV manuals search

<http://tv.somanuals.com>