

## Operating instructions

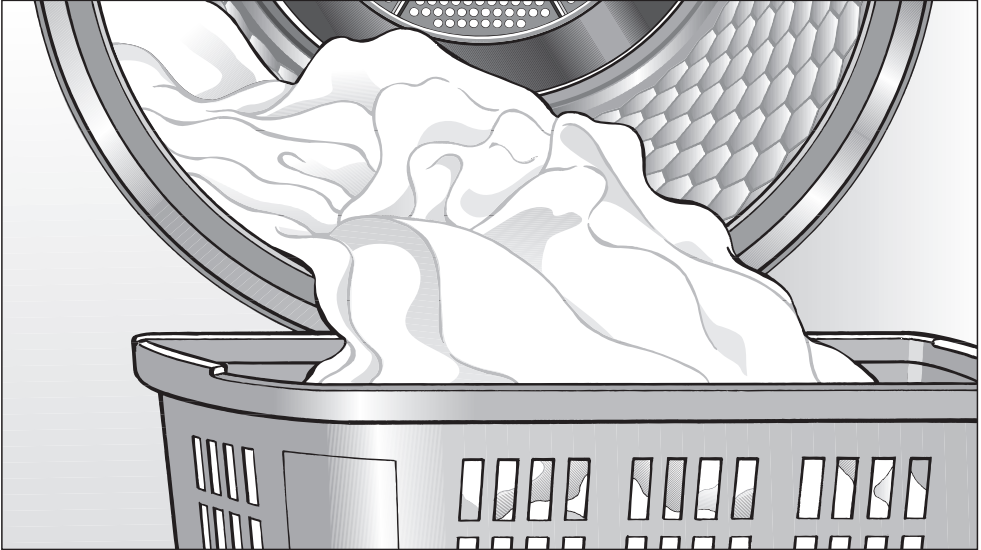

## for condenser tumble dryer T 8822 C

To avoid the risk of accidents  
or damage to the appliance  
it is **essential** to read these  
instructions before it is installed  
and used for the first time.

en - GB

M.-Nr. 07 847 520

# Caring for the environment

---

## Disposal of the packing material

The transport and protective packing has been selected from materials which are environmentally friendly for disposal and should be recycled.

Ensure that any plastic wrappings, bags, etc are disposed of safely and kept out of the reach of babies and young children. Danger of suffocation.

## Disposal of your old appliance

Electrical and electronic appliances often contain materials which, if handled or disposed of incorrectly could be potentially hazardous to human health and to the environment. They are, however, essential for the correct functioning of your appliance. Please do not therefore dispose it with your household waste.

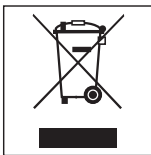

Please dispose of it at your local community waste recycling centre or contact your dealer for advice. Ensure that it presents no danger to children while being stored for disposal.

## Energy saving tips

To avoid unnecessarily long drying times and high consumption of energy:

- Make sure that your laundry is thoroughly spun before drying.

The higher the spin, the greater the savings that can be made in energy and time during drying.

- Load according to the optimum amount of laundry recommended for the programme being used (see Programme chart).

Underloading is uneconomical. Overloading gives a poorer quality of drying and may cause unnecessary creasing.

- Make sure the room in which the dryer is located is well ventilated.
- Make sure the fluff filters are clean before using the dryer.
- Check the condenser unit from time to time and clean it when necessary.

<b>Caring for the environment</b> . . . . .	2
<b>Warning and Safety instructions</b> . . . . .	6
<b>Operating the tumble dryer</b> . . . . .	14
Control panel . . . . .	14
<b>Notes on laundry care</b> . . . . .	16
Garment care label symbols . . . . .	16
Tips on drying . . . . .	16
<b>How to dry correctly</b> . . . . .	17
Brief instructions . . . . .	17
<b>Extra options / Delay start</b> . . . . .	20
Extra options . . . . .	20
Low temperature . . . . .	20
Buzzer . . . . .	20
Delay start . . . . .	20
<b>Programme chart</b> . . . . .	21
<b>Changing the programme sequence</b> . . . . .	24
Once a programme has started . . . . .	24
- changing the programme . . . . .	24
- cancelling the programme and then selecting a different programme . . . . .	24
- cancelling the programme and then removing the laundry . . . . .	24
Altering Delay start . . . . .	24
Adding or removing laundry after a programme has started . . . . .	24
Time remaining . . . . .	24
<b>Electronic system lock</b> . . . . .	25

# Contents

---

<b>Cleaning and care</b> . . . . .	26
Emptying the condensed water container . . . . .	26
Cleaning the fluff filters . . . . .	27
Cleaning them whilst dry . . . . .	27
Cleaning them with water . . . . .	28
Cleaning the tumble dryer . . . . .	29
Cleaning the condenser unit . . . . .	30
Removing the condenser unit. . . . .	30
Checking the condenser unit . . . . .	31
Cleaning the condenser unit. . . . .	31
Replacing the condenser unit. . . . .	32
<b>Problem solving guide</b> . . . . .	33
Check and fault messages . . . . .	33
An unsatisfactory drying result . . . . .	36
Other problems . . . . .	37
Changing the lamp . . . . .	39
<b>After Sales service</b> . . . . .	40
Repairs. . . . .	40
Future updates (PC) . . . . .	40
Appliance guarantee . . . . .	40
Optional accessories . . . . .	40
<b>Installation</b> . . . . .	41
Front view. . . . .	41
Rear view . . . . .	42
Installation site . . . . .	42
Transporting the dryer to its installation site . . . . .	42
Building under a continuous worktop / in a kitchen run . . . . .	42
Levelling the appliance. . . . .	43
Room ventilation . . . . .	43
Washer-dryer stack. . . . .	43
Before moving the tumble dryer again (e.g. when moving house) . . . . .	43

External condensed water outlet . . . . .	44
Arranging the drain hose . . . . .	44
External drainage via a sink or gully . . . . .	45
Installation conditions requiring a non-return valve . . . . .	45
<b>Electrical connection . . . . .</b>	<b>47</b>
Electrical connection U.K. . . . .	47
<b>Consumption data . . . . .</b>	<b>48</b>
<b>Technical data . . . . .</b>	<b>49</b>
<b>Programmable functions . . . . .</b>	<b>50</b>
Altering the residual moisture level in the Cottons programme. . . . .	50
Altering the residual moisture level in the Minimum iron programme . . . . .	51
Anti-crease . . . . .	52
Altering the volume of the buzzer . . . . .	53
Altering the standard drying level in the Automatic plus programme . . . . .	54
Extending the cooling down time . . . . .	55
Standby . . . . .	56
Memory function . . . . .	58
Clean out airways indicator . . . . .	59
Keypad tone . . . . .	60
Adjusting the dryer's electronics for very soft water . . . . .	61
Extending the range of the drying levels. . . . .	62

# Warning and Safety instructions

---

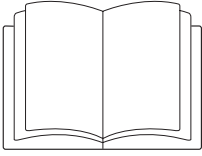

► It is **essential** to read these instructions.

This tumble dryer conforms to current safety requirements. Inappropriate use can, however, lead to personal injury and damage to property.

To avoid the risk of accidents and damage to the tumble dryer, please read these instructions carefully before using it for the first time. They contain important information on its safety, installation, use and maintenance.

Keep these instructions in a safe place and ensure that new users are familiar with the content. Pass them on to any future owner.

## Correct application

► This tumble dryer is not designed for commercial use. It is intended for use in domestic households and similar working and residential environments.

► The tumble dryer is not intended for outdoor use.

► It must only be used as a domestic appliance to dry items which have been washed in a water solution and which are marked on the manufacturer's care label as being suitable for tumble drying. If using dry cleaning kits, do so at your own risk, and follow the instructions provided on the packaging.

Any other usage is not supported by the manufacturer and could be dangerous. Miele cannot be held liable for damage resulting from incorrect or improper use or operation.

## Warning and Safety instructions

---

▶ The tumble dryer can only be used by people with reduced physical, sensory or mental capabilities, or lack of experience or knowledge, if they are supervised whilst using it or have been shown how to use it in a safe way and understand the hazards involved.

### **Safety with children**

▶ Children under 8 years of age must be kept away from the tumble dryer unless they are constantly supervised.

▶ Children 8 years and older may only use, clean or maintain the tumble dryer without supervision if they have been shown how to do so in a safe way and understand the hazards involved.

▶ The tumble dryer is not a toy! To prevent the risk of injury, do not allow children to play with it or near it, or to play with the controls.

# Warning and Safety instructions

---

## Technical safety

▶ Before setting up the tumble dryer, check it for any externally visible damage.

Do not install or use a damaged tumble dryer.

▶ Before connecting the tumble dryer, ensure that the connection data on the data plate (voltage and frequency) match the mains electricity supply. If in any doubt, consult a qualified electrician.

▶ The electrical safety of this tumble dryer can only be guaranteed when correctly earthed. It is most important that this basic safety requirement is observed and regularly tested, and where there is any doubt, the household wiring system should be inspected by a qualified electrician. Miele cannot be held liable for the consequences of an inadequate earthing system (e.g. electric shock).

▶ Do not connect the tumble dryer to the mains electricity supply by an extension lead. Extension leads do not guarantee the required safety of the tumble dryer (e.g. danger of overheating).

▶ If the electrical connection cable is faulty it must only be replaced by a Miele approved service technician to protect the user from danger.

▶ Unauthorised repairs could result in unforeseen dangers for the user, for which Miele cannot accept liability. Repairs should only be undertaken by a Miele approved service technician, otherwise any subsequent damage will not be covered by the guarantee. Ensure current is not supplied to the tumble dryer until after maintenance or repair work has been carried out.



## Warning and Safety instructions

---

- ▶ Faulty components must only be replaced by genuine Miele original spare parts. Only when these parts are fitted can the safety standards of the tumble dryer be guaranteed.
- ▶ The tumble dryer must be isolated from the electricity supply in the event of a fault and during cleaning and maintenance.
- ▶ The tumble dryer must not be used in a non-stationary location (e.g. on a ship).
- ▶ Do not make any alterations to the tumble dryer, unless authorised to do so by Miele.
- ▶ In areas which may be subject to infestation by cockroaches or other vermin, pay particular attention to keeping the tumble dryer and its surroundings in a clean condition at all times. Any damage which may be caused by cockroaches or other vermin will not be covered by the guarantee.

# Warning and Safety instructions

---

## Correct use

- ▶ To prevent the risk of fire, the following textiles must not be dried in this appliance:
  - items which have not been washed.
  - items, such as workwear, which have not been thoroughly cleaned and which are still soiled with grease, oil or other deposits (such as cosmetics, lotions etc).  
If items have not been thoroughly cleaned there is a danger that these might self-ignite when heated, even after they have been removed from the dryer at the end of the programme.
  - items (e.g. mops and floor cloths) which have been treated with inflammable cleaning agents or which contain residues of acetone, alcohol, benzine, petrol, kerosene, stain remover, turpentine, wax and wax remover or other chemicals.
  - items which have been splashed with hair lacquer, hair spray, nail varnish remover or similar substances.

When washing such heavily soiled items, ensure that you use additional detergent and select a high temperature. If in doubt, wash the items several times.

- ▶ Remove all items such as lighters and matches from pockets.
- ▶ **Warning:** Do not switch the tumble dryer off before the drying programme has finished. If this is done, the laundry must be hung up or spread out to cool it down.

## Warning and Safety instructions

---

### ▶ Danger.

This tumble dryer must not be connected to a controllable socket (e.g. a timer switch or a peak load shut-off device).

If the dryer programme were to be interrupted before the end of the cooling down phase, the laundry could self-combust.

### ▶ To prevent the risk of fire, the following must not be tumble dried:

- items which have been cleaned using chemicals (e.g. professional dry-cleaning agents).
- fabrics which contain a large proportion of rubber, foam rubber or rubber-like materials. For example, products made from latex foam rubber, shower caps, waterproof textiles, rubberised articles and items of clothing and pillows with foam rubber filling.
- damaged items which contain padding or fillings (e.g. pillows, jackets). When damaged, the filling can get out with the risk of igniting in the dryer.

▶ In many programmes, the heating phase is followed by a cooling down phase to ensure that the items are not too hot to handle when you remove them (this also avoids the danger of the laundry self-igniting). The programme is not finished until the cooling down phase has been completed.

As soon as the programme has finished, remove all laundry from the drum.

▶ Fabric conditioner and similar products must be used according to the instructions on the manufacturer's packaging.

▶ Do not let anyone sit or lean on the door, as this can cause the tumble dryer to tip up.

▶ Always close the door after use. This way you will avoid the danger of:

- children climbing into the dryer or hiding things in it.
- pets or other small animals climbing into it.

## Warning and Safety instructions

---

- ▶ The dryer must not be used without the fluff filters in place or if the fluff filters are damaged in any way.
- ▶ The fluff filters must be cleaned regularly.
- ▶ The dryer must not be used without the condenser unit in place.
- ▶ The fluff filters must be thoroughly dried after cleaning. Damp or wet filters could cause operational faults.
- ▶ Do not install the tumble dryer in a room where there is a risk of frost occurring. At temperatures around freezing point the tumble dryer may not be able to operate properly. There is a risk of damage if the condensed water is allowed to freeze in the pump and in the drain hose. The ambient room temperature should be between +2°C and +35°C.
- ▶ If the water is drained externally instead of being collected in the condensed water container, make sure the drain hose is securely attached if you hang it in a sink or basin to avoid the hose slipping and the water causing damage.
- ▶ Condensed water is not drinking water. It can cause health problems in both people and animals.
- ▶ Always keep the area around the tumble dryer free of dust and fluff. Dust drawn into the tumble dryer can cause blockages in the condenser unit over time.
- ▶ The tumble dryer must not be hosed down.

## Accessories

► Only use genuine Miele original spare parts and accessories with this tumble dryer.

If non-Miele parts are used, guarantee, performance and product liability claims may be invalidated.

Miele cannot be held liable for damage caused by non-compliance with these Warning and Safety instructions.

# Operating the tumble dryer

## Control panel

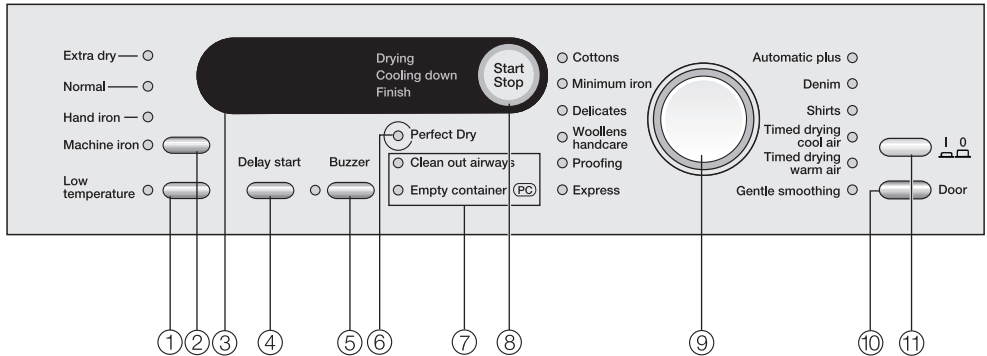

### ① **Low temperature button**

Delicate fabrics are dried at a lower temperature.

### ② **Drying level button**

with indicator lights to show the drying level selected.

### ③ **Display**

See next page.

### ④ **Delay start button**

This button is used for:

- Delaying the start of a programme
- Selecting the duration of the timed drying *Warm air* and *Cool air* programmes

### ⑤ **Buzzer button**

An audible tone sounds at the end of the programme.

### ⑥ **Perfect Dry indicator**

For all programmes with a selectable drying level. See next page.

### ⑦ **Check lights**

For a description of these, see "Problem solving guide" / "After sales service".

### ⑧ **Start/Stop button**

For starting or cancelling a programme.

The button flashes while a programme is being selected and then lights up constantly when the programme has started.

### ⑨ **Programme selector**

with indicator lights to show the programme selected.

### ⑩ **Door button**

Pressing this button will open the door even when the dryer is switched off at the mains.

### ⑪ **On/Off button**

For switching the dryer on and off.

## The display shows:

- Programme duration
- Programme stage
  - Drying*
  - Cooling down*
  - Finish*
- Check and fault messages

## The following are also selected via the display:

- Duration of the *Warm air* and *Cool air* programmes
- Delay start

You can select a programme and set it to start at a later time.

The programme will start automatically once the delay start time has elapsed.

- Programmable functions

Default settings can be altered to adapt the dryer to different requirements. See "Programmable functions" at the end of this booklet for more details.

## **Perfect Dry indicator**

The Perfect Dry system measures the residual content in the laundry in the sensor drying programmes to ensure perfect drying results.

After a programme has started, the electronics will estimate the duration of the programme (time remaining). The *Perfect Dry* indicator will flash while this is happening.

After a short while, the programme duration will appear in the display and the indicator will go out.

The *Perfect Dry* indicator will light up again when the selected drying level is reached and remain on until the programme is finished.

The *Perfect Dry* indicator does not light up during time controlled programmes: *Woollens handcare*, *Cool air*, *Warm air*, *Gentle smoothing*.

## Programme duration / Estimated time remaining







The estimated duration (time remaining) will appear in the display.

The following factors all affect the estimated time remaining: residual moisture content after spinning; type of fabric; size of load; room temperature; fluctuations in power supply.

The electronics continually assess conditions in the dryer and adjust the estimated time remaining for a more accurate reading. Because of this, the time displayed can alter during the course of a programme. Programmes can also finish earlier than expected, if, for example, particularly fine fabrics are being dried, the load is very small or items were partially dry beforehand.

# Notes on laundry care

## Garment care label symbols

Drying	
	Normal/higher temperature
	Reduced temperature: Select <i>Low temperature</i> (for delicate textiles)
	Do not tumble dry
Ironing	
	Very hot
	Hot
	Warm
	Do not iron

## Tips on drying

- Always observe the maximum recommended loads given in the "Programme chart". Never overload the drum.
- Overloading can cause unnecessary wear and tear to the laundry, give a disappointing drying result and cause more creasing.
- Do not put soaking wet items into the tumble dryer. Spin fabrics for at least 30 seconds before drying.
  - Open jackets so that they can dry evenly.
  - Use the *Automatic plus* programme for drying mixed loads of cotton and minimum iron fabrics.
  - Woollens and wool blends tend to become matted and shrink if dried in a tumble dryer. They can, however, be "fluffed up" using the *Woollens handcare* programme.

- Down-filled garments have linings which have a tendency to shrink, depending on the quality of the item. They can be partially dried using the *Gentle smoothing* programme.
- Pure linen should only be machine dried if specified as suitable by the manufacturer on the care label, as the surface of the fabric may otherwise become rough.
- Loopknit garments (e.g. T-shirts and underwear) tend to shrink depending on their quality. Do not over-dry these textiles. When purchasing these garments it is advisable to take their shrinkage properties into account.
- Minimum iron fabrics tend to crease more, the larger the load. This is also the case for garments made from very fine weave fabrics, such as shirts or blouses. If in doubt, divide the garments into smaller loads.
- Starched laundry can be dried in the tumble dryer. To achieve the usual finish, double the amount of starch should be used.
- New dark coloured garments should be washed and dried separately from light coloured garments to avoid the danger of colours running and discolouring other garments or even plastic components in the dryer. Dark coloured fibres can also settle on light coloured garments and vice versa.



## Brief instructions

The headings numbered (1, 2, 3 ...) show the operating sequence and can be used as a brief guide to using your dryer.

### 1 Sort the laundry

To ensure an even drying result sort laundry according to:

- ... the drying level required
- ... the type of fibre or weave
- ... size
- ... the moisture content after spinning.

 Make sure that objects e.g. detergent dispensing balls have been removed from the laundry. They could melt, and cause damage to the dryer or the laundry.

- Check seams and stitching to ensure that padding and linings are intact.
- Fasten duvet covers and pillow cases to prevent small items from being trapped inside them.
- Fasten hooks and eyes etc.
- Tie fabric belts and apron strings.
- Sew in or remove underwiring from bras.

### 2 Turn on the tumble dryer

- Switch the dryer on by pressing the *On/Off*  button in.

The tumble dryer may be switched on after loading, saving energy as the light will not come on.

### 3 Load the tumble dryer

- Press the *Door* button to open the door.
- Load the laundry loosely into the drum.

Do not overload the drum. See the "Programme chart" for recommended loads for each programme. Overloading can cause unnecessary wear and tear to the laundry and give a disappointing drying result.

- Before closing the door make sure the fluff filter is correctly positioned.

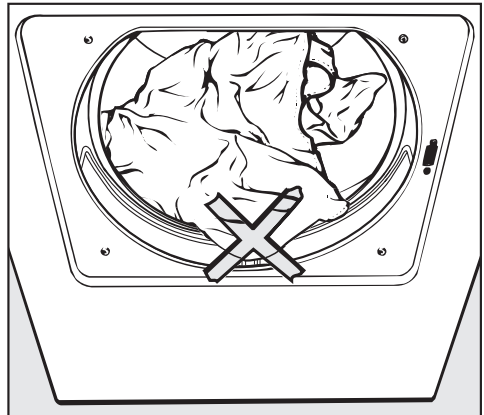

Check the laundry is right inside the drum so that it cannot get trapped or damaged when the door is shut.

- Shut the door either with a gentle swing, or lean against it and push it shut.

# How to dry correctly

## 4 Select a programme

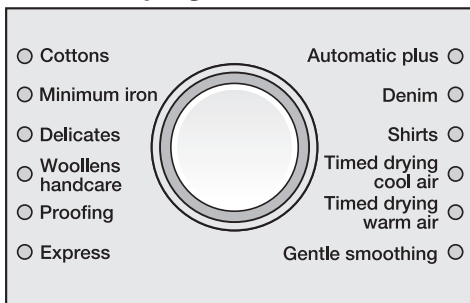

- Select the programme you want.

The indicator for the programme selected will light up.

A drying level or extra option indicator may also light up and the duration may also be displayed.

### Drying level programmes

- *Cottons, Minimum iron, Delicates, Proofing, Express, Automatic plus, Denim, Shirts*

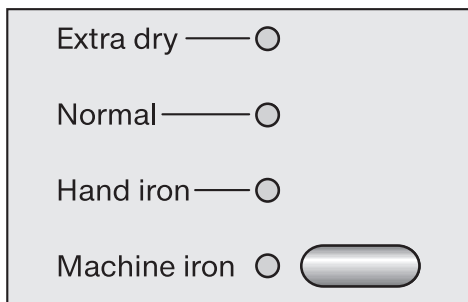

- Press the drying level button repeatedly until the indicator for the drying level you want lights up (for almost all programmes).

Any of the four drying levels can be selected for the *Cottons* and *Express* programmes. A more limited range is available when using other

programmes and with some the drying level is pre-set and cannot be changed.

### Note

You can extend the range of the drying levels for some programmes (see "Programmable functions").

### **Woollens handcare, Gentle smoothing**

- This programme cannot be changed.

### Selecting the duration of the timed drying *Cool air* and *Warm air* programmes

The indicator light for the *Delay start* button will flash when the *Cool air* or *Warm air* programme is selected.

- Press the *Delay start* button repeatedly until the required duration shows in the display.

You can select the duration in stages for:

- *Cool air*: from **20** minutes up to **1:00** hour.
- *Warm air*: from **15** minutes up to **2:00** hours.

## 5 Select any Extra options / Delay start

- *Low temperature, Buzzer* and *Delay start* (see "Extra options/Delay start") are selected by pressing the appropriate button. *Anti-crease* (see next page) is permanently switched on.

**N.B.:** It is not possible to select *Delay start* when using the *Warm air* or *Cool air* programmes.

## ⑥ Start the programme

The *Start/Stop* button will flash when a programme is being selected. The flashing indicates that a programme can be started.

- Press the *Start/Stop* button.

The *Start/Stop* button will now light up constantly.

The *Perfect Dry* indicator will flash or light up constantly with the sensor controlled drying programmes. It will not come on at all with timed drying programmes (see "Operating the tumble dryer").

Please note: The duration shown in the display is an estimate and can vary.

## Before the end of a programme

There is a cooling down phase at the end of the drying sequence (*Cooling down* will light up). The programme will not finish until the cooling down phase has been completed.

There is no cooling down phase at the end of the *Woollens handcare* programme.

## ⑦ Remove the laundry at the end of the programme

*0* and *Finish* will appear in the display to indicate that the programme has finished. The buzzer (if selected) will sound at intervals.

The drum will continue to rotate at intervals for up to two hours to prevent laundry creasing, if you do not wish to remove it immediately (anti-crease). There is no anti-crease phase at the end of the *Woollens handcare* programme.

- Press the *Door* button.
- Open the door.
- Remove the laundry.

Check that all items have been removed from the drum. If items are left in the dryer, they could be damaged by overdrying when the dryer is next used.

If the dryer is switched on at the mains and the door is opened, the drum lighting will come on. It will go out a few minutes later to save energy.

- Press the  button to switch the dryer off.
- Clean the fluff filters.
- Close the door.
- Empty the condensed water container (unless the dryer has been connected for external drainage).
- The condenser unit should be checked and cleaned on a regular basis (see "Cleaning and care").

# Extra options / Delay start

---

## Extra options

### Low temperature

Delicate and minimum iron fabrics with the  symbol on the care label (e.g. acrylic garments) are dried at a lower temperature. The programme duration is longer.

On some programmes *Low temperature* is permanently activated and so cannot be deselected.

### Buzzer

A buzzer sounds (at intervals for a maximum of 1 hr) to let you know the programme has finished.

A continuous alarm will sound if there is a fault even if the buzzer has been switched off.

## Delay start

You can delay the start of a programme by 30 minutes up to 24 hours.

- Select a programme.
- Press the *Delay start* button repeatedly until the required delay period shows in the display.
  - The *Delay start* indicator light will flash.
  - Times of up to **10h** are selected in steps of half an hour, and more than **10h** in one-hour steps.
  - If you keep the *Delay start* button pressed in, the time will continue to increase up to **24h**.

## To begin delay start

- Press the *Start/Stop* button.
  - The *Delay start* indicator will light up constantly.
  - Delay start times of more than **10h** will count down in hours, and of less than **10h** in minutes to the start of the programme.
  - The drum will turn briefly every hour to help prevent creasing.

## To cancel / alter delay start



- Press the *Start/Stop* button to cancel delay start.
- To alter the delay start time, press the *Delay start* button repeatedly until the required delay period shows in the display.
- Press the *Start/Stop* button to start the altered delay start time counting down from the beginning again.

## To add laundry after the delay start time has started counting down

While the delay start time is counting down, you can still add laundry to the drum:

- Switch the dryer off.
  - Opening the door without switching the dryer off will cancel delay start.
- Open the door and add the laundry.
- Close the door and switch the dryer back on again.

## Programme chart

<b>Cottons</b>		<b>Max. load 7 kg*</b>
<b>Extra dry, Normal**</b>		
Use for	Single and multi-layered cotton fabrics such as towelling, T-shirts, underwear, flannelette bed linen.	
Notes	<ul style="list-style-type: none"> <li>– Select <i>Extra dry</i> for multi-layered and very thick fabrics.</li> <li>– Do not use <i>Extra dry</i> for loopknit fabrics (e.g. T-shirts, underwear, baby clothes), as they have a tendency to shrink.</li> </ul>	
Low temperature	Select the Low temperature option for delicate fabrics with the  symbol on the care label.	
<b>Hand iron, Machine iron</b>		
Use for	Cottons or linen fabrics, e.g.: table linen, bed linen, starched laundry.	
Note	– To prevent laundry from drying out it should be rolled up until you are ready for ironing.	
Low temperature	Select the Low temperature option for delicate fabrics with the  symbol on the care label.	
<b>Minimum iron</b>		<b>Max. load 3.5 kg*</b>
<b>Normal, Hand iron</b>		
Use for	Minimum iron items made of cotton, synthetic or blended fabrics, e.g.: dresses, trousers, skirts and table cloths.	
Low temperature	Select the Low temperature option for delicate fabrics with the  symbol on the care label.	
<b>Delicates</b>		<b>Max. load 2.5 kg*</b>
<b>Normal, Hand iron</b>		
Use for	Delicate items made of synthetic fibres, easy care cotton or blended fabrics, e.g. shirts, blouses, lingerie and appliquéd garments.	
Low temperature	Low temperature cannot be deselected.	

\* Weight of dry laundry

\*\* Note for test institutes:

Test programme (without selecting any Extra options) in accordance with Regulation 392/2012/EU for energy labelling measured in accordance with EN 61121.

# Programme chart

<b>Woollens handcare</b>		<b>Max. load 2 kg*</b>
Fabric type	Woollen fabrics	
Notes	<ul style="list-style-type: none"> <li>– This programme only fluffs up woollen garments. They are not dried completely by this programme.</li> <li>– Remove garments as soon as the programme has finished and leave to finish drying at room temperature.</li> </ul>	
Low temperature	Low temperature cannot be deselected.	
<b>Proofing</b>		<b>Max. load 2.5 kg*</b>
<b>Normal</b>		
Fabric type	For drying microfibre fabrics, skiwear, fine, closeweave cotton garments (poplin) or tablecloths which are suitable for drying in a tumble dryer and have been treated to provide a water and dirt resistant finish.	
Notes	<ul style="list-style-type: none"> <li>– This programme includes a proofing fixing phase.</li> <li>– <b>Only use proofing agents containing fluorochemical compounds which are stated by the manufacturer as being "suitable for use on membrane textiles."</b></li> <li>– <b>Do not dry items which have been treated with proofing agents containing paraffin. Fire hazard!</b></li> </ul>	
<b>Express</b>		<b>Max. load 3.5 kg*</b>
<b>Extra dry, Normal, Hand iron, Machine iron</b>		
Fabric type	Fabrics which can tolerate high temperatures with the ☼ symbol on the care label and which can be dried in the <i>Cottons</i> programme.	
Note	– The programme duration is shorter.	
<b>Automatic plus</b>		<b>Max. load 5 kg*</b>
<b>Normal, Hand iron</b>		
Fabric type	Mixed loads of garments suitable for the <i>Cottons</i> and <i>Minimum iron</i> programmes. Sort according to colour.	
<b>Denim</b>		<b>Max. load 3 kg*</b>
<b>Normal, Hand iron</b>		
Fabric type	Denim garments, e.g. jeans, jackets, skirts, shirts.	
Low temperature	Select the Low temperature option for delicate fabrics with the ☼ symbol on the care label.	

\* Weight of dry laundry

## Programme chart

<b>Shirts</b>		<b>Max. load 2 kg*</b>
<b>Normal, Hand iron</b>		
Fabric type	Shirts and blouses.	
Low temperature	Select the Low temperature option for delicate fabrics with the ☐ symbol on the care label.	
<b>Cool air</b>		<b>Max. load 7 kg*</b>
Fabric type	Any item which only needs airing.	
<b>Warm air</b>		<b>Max. load 7 kg*</b>
Fabric type	<ul style="list-style-type: none"> <li>– Voluminous and multi-layered fabrics whose layers have different drying characteristics, e.g. jackets, pillows.</li> <li>– For drying individual items, e.g. bath towels, swimwear, tea-towels.</li> </ul>	
Note	– Do not select the longest drying time to start with. Check the items as you are drying them to find the optimum time.	
Low temperature	Select the Low temperature option for delicate fabrics with the ☐ symbol on the care label.	
Note	You can use the <i>Warm air</i> programme to help remove odours from clean cotton clothing (select a duration of between 1/2 and 1 hour). Items must be suitable for drying in a tumble dryer. Dampen the garments a little beforehand or add a fabric conditioner sheet. Odours will not be removed as effectively from any parts of the garments which are made of synthetic fibres.	
<b>Gentle smoothing</b>		<b>Max. load 1 kg*</b>
Fabric type	<ul style="list-style-type: none"> <li>– Cotton and linen fabrics.</li> <li>– Minimum iron items made of mixed fibres, cottons or synthetics, e.g.: trousers, anoraks, shirts.</li> </ul>	
Notes	<ul style="list-style-type: none"> <li>– Smooths out creasing caused during the spin cycle in the washing machine.</li> <li>– Remove garments as soon as the programme has finished so that they are easy to iron.</li> </ul>	
Low temperature	Low temperature cannot be deselected.	

\* Weight of dry laundry

# Changing the programme sequence

---

## Once a programme has started

### - changing the programme

You cannot change to another programme once a programme has started (this prevents unintentional alterations).

You will need to cancel the current programme before you can select a new one.

### - cancelling the programme and then selecting a different programme

- Press the *Start/Stop* button.

The items will be cooled down, depending on the temperature reached and how long they have been dried for.

If you press the *Start/Stop* button again during the cooling down phase, *Finish* will light up in the display.

- Press the *Door* button.
- Close the door.
- Select another programme and start it.

### - cancelling the programme and then removing the laundry

- Proceed as described in "Adding or removing laundry after a programme has started" below.
- Switch the dryer off after closing the door.

## Altering Delay start

- See "Delay start".

## Adding or removing laundry after a programme has started

- Press the *Door* button.
- Open the door.



Danger of burning:

Do not touch the back of the drum when adding or removing items. The drum and the items can get very hot.

- Add or remove items as required.
- Close the door.
- Press the *Start/Stop* button.

## Time remaining

The time left shown in the display may now vary from the actual drying time.



The system lock prevents the dryer being used without your knowledge.

It can be activated if wished.

The dryer's electronics are then locked. The dryer can still be switched on but a programme cannot be started.

- If an attempt is made to start a programme, the indicator light for the *Low temperature* button will come on and a key symbol  will appear in the display.

The door is not locked and can be opened at any time.

## To activate the lock

Before you begin, first ensure that:

- The tumble dryer is switched off.
- The door is closed.

❶ Press the *Low temperature* button and keep it pressed in whilst carrying out steps ❷ to ❸.

❷ Press the  button in.

The *Automatic plus* indicator light will come on.

❸ Slowly turn the programme selector three positions stage by stage in a clockwise direction. Each of the three programme indicator lights must come on one after the other.

❹ Now slowly turn the programme selector six positions stage by stage in an anti-clockwise direction. Each of the six programme indicator lights must come on one after the other.

The indicator light for the *Low temperature* button will flash, and a key symbol  will appear in the display.

❺ Release the *Low temperature* button.

The electronics have now been locked.

- Switch the dryer off.

## To deactivate the lock

Before you begin, first ensure that:

- The tumble dryer is switched off.
- The door is closed.

■ The procedure is the same as for activating the lock. Carry out steps ❶ to ❺ as described previously.

At step ❺ the indicator light for the *Low temperature* button will stop flashing and the key symbol  will go out.

The electronics are no longer locked.

# Cleaning and care

## Emptying the condensed water container

The condensed water will be collected in the condensed water container unless the dryer has been connected for external drainage (see "Installation").

Empty the condensed water container after every drying programme.

The *Empty container* indicator will light up if the maximum level of the condensed water container is reached. The indicator light will go out when the door is opened and closed again.

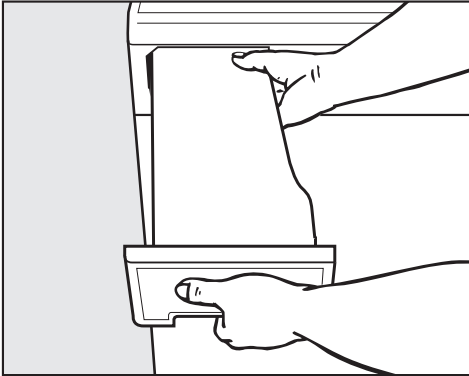

- Pull out the condensed water container.
- To prevent water running out, hold it at the front and towards the back and keep it in a horizontal position when carrying it.

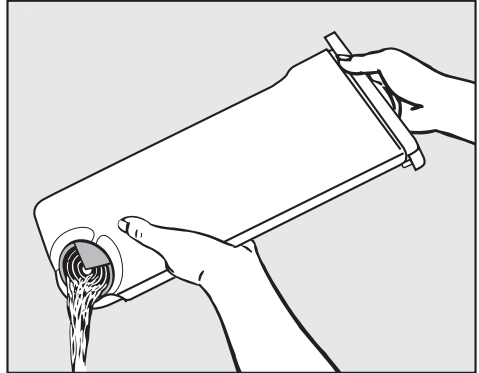

- Empty the container.
- Replace the container in the dryer.

 Condensed water should not be consumed. It could lead to health problems for people and animals.

Condensed water can be put to household use (e.g. in a steam iron or humidifier). To ensure that any residual particles of fluff in the condensed water are removed before use, pass it through a fine sieve or paper filter first.

## Cleaning the fluff filters

The fluff which is created by the drying process is collected by the fluff filters in the door and the door opening. Clean the filters after **each** drying programme\*.

### Cleaning them whilst dry

Tip: You can also use a vacuum cleaner to remove the fluff.

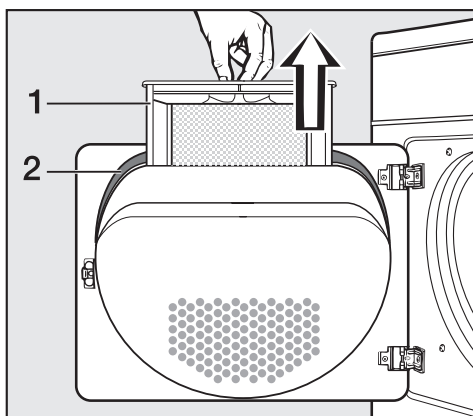

- Open the door and pull the fluff filter (1) out of the door as illustrated.

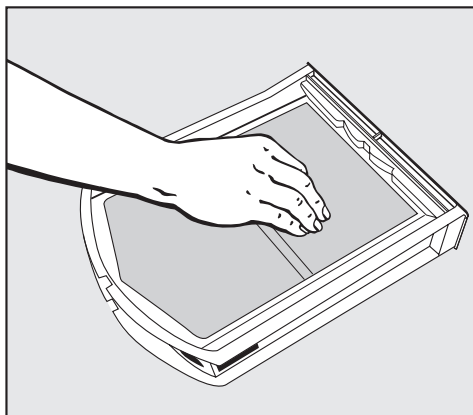

- Use your fingers to remove the fluff from the surface of the filter.

- Remove any fluff from the hollow part of the door opening. You could also use a cleaning brush which is available as an optional extra from your Miele dealer or the Miele Spare Parts Department, or use a vacuum cleaner.
- Also clean the door seal (2) with a damp cloth.
- Once clean, push the filter back into the door holder until it clicks into position. Ensure it is facing the correct way.

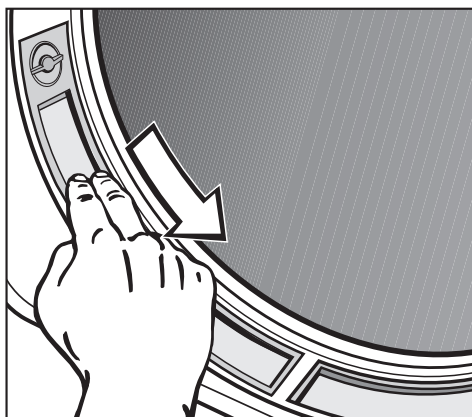

- Use your fingers or a vacuum cleaner to remove the fluff from the two fluff filters in the door opening.
- Close the door.

\* Always check the fluff filters if the *Clean out airways* indicator light comes on.

# Cleaning and care

## Cleaning them with water

If there is a great deal of compacted fluff on any of the filters, they can be removed and cleaned under hot running water.

- Open the door and pull the fluff filter out of the door as described previously.

The two filters in the door opening can also be removed if you need to clean them with water.

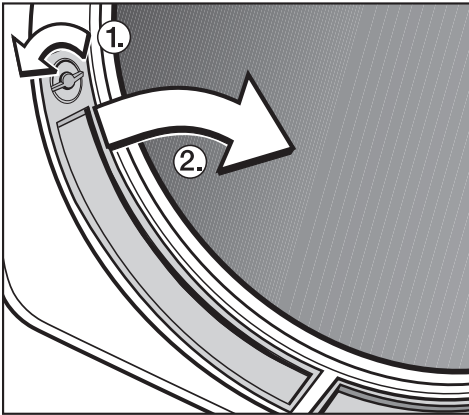

- Turn dial ① and pull the filter by the dial out of the door opening as shown ②. Do the same on the other side.
- Rinse all the filters under hot, running water.
- Then shake the filters until no more water droplets are visible.
- Dry the filters thoroughly with care.
- Clean the area underneath these filters, e.g. with a vacuum cleaner.

⚠ Do not replace them if they are damp or wet. Damp or wet filters could cause operational faults.

- Push the large filter back into the door holder until it clicks into position. Ensure it is facing the correct way.
- Replace the filters in the door opening by first inserting them at the bottom and then pressing them into place at the top.
- Lock both dials.

### Cleaning the tumble dryer

Disconnect the tumble dryer from the mains electricity supply.

Miele branded cleaning and conditioning products are available to order via the internet on [www.miele-shop.com](http://www.miele-shop.com).

- Clean the housing and control panel with a slightly damp cloth and a mild detergent or soapy water.
- The drum and other stainless steel parts can be cleaned with a suitable stainless steel cleaner following the manufacturer's instructions.

**Do not** use solvents, abrasive cleaners, glass cleaners or all-purpose cleaners. These could damage plastic surfaces and other parts.

- Dry all parts with a soft cloth.

# Cleaning and care

## Cleaning the condenser unit

Detergent residue, hair and fine fluff from the dryer can get through the fluff filters and block the condenser unit. Dust from the room in which the dryer is installed can also get into the condenser unit and cause a blockage.

**Check** the condenser unit at least once a year. Always check it if the *Clean out airways* indicator light comes on. Clean it if necessary.

### Removing the condenser unit

- Open the service panel. Hold the panel securely when doing this.

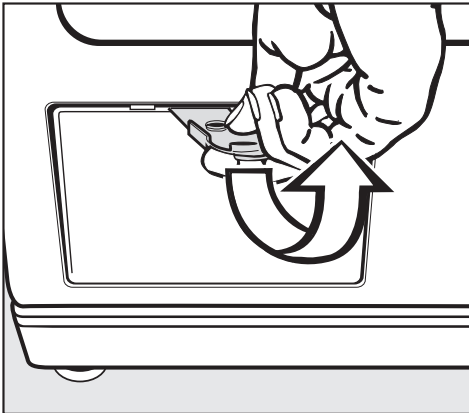

- Now remove the panel by pulling it diagonally upwards and place it to one side.

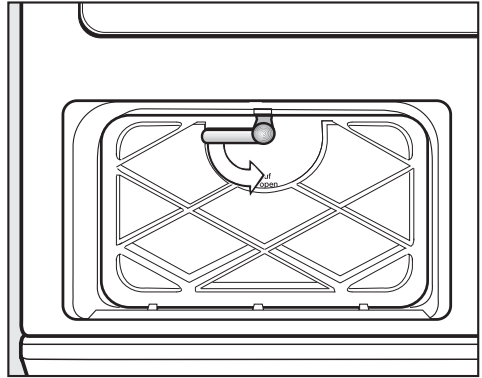

- Turn the lever on the inner cover downwards to the vertical position.
- Tilt the cover forwards.
- Remove it by pulling it diagonally upwards.

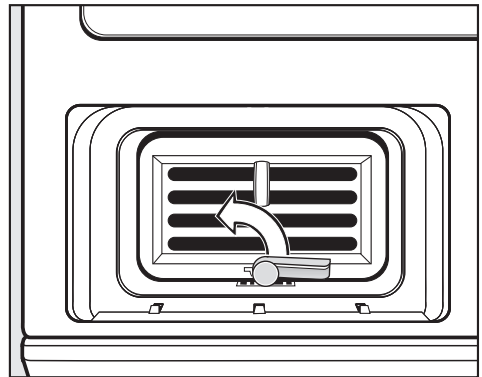

- Turn the lever on the condenser unit upwards to the vertical position so that the hook on the lever is no longer in the groove at the bottom of the condenser unit housing.

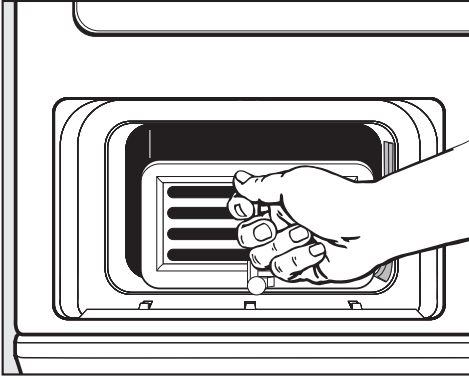

- Pull the condenser unit out of its housing by the handle.

### Checking the condenser unit

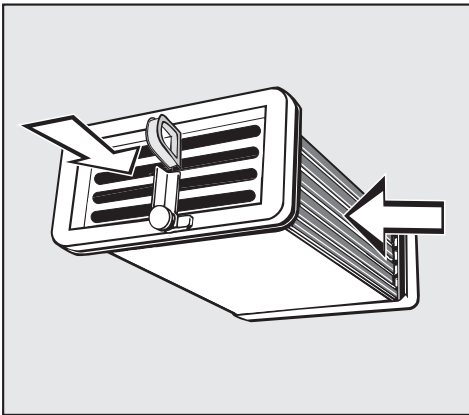

- Hold the condenser unit up to the light **as shown**.
- Check to see if there is any fluff inside it.  
The arrows in the illustration above indicate where to look.

If you cannot see any fluff:

- Replace the condenser unit (see following page).

If you can see some fluff:

- Clean the condenser unit as described below.

### Cleaning the condenser unit

- **When rinsing the condenser unit, make sure you position it as shown in the next two illustrations.**

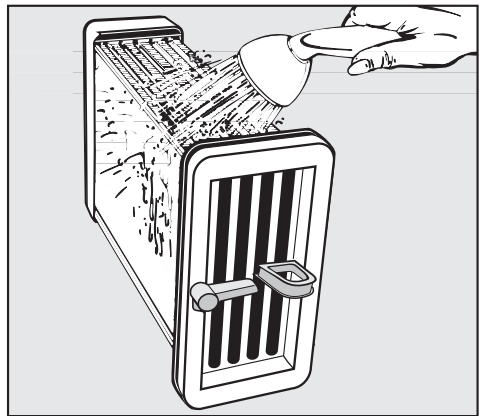

- Use a shower head or similar to rinse the unit out **as shown**.

## Cleaning and care



- Then flush the unit through from the front.
- Check the condenser unit again for any visible fluff and if necessary flush it through again until it has all gone.
- Repeat as required.
- Also make sure the rubber seals are clean.  
The rubber seals must not be removed and must be free of kinks.
- Shake the water off the condenser unit until no more droplets of water are visible.

### Checking and cleaning the condenser unit housing

- Remove any soiling still visible inside the housing unit by hand using a damp cloth. Do not try and access areas you cannot reach by hand!

### Replacing the condenser unit

- **With the handle facing upwards,** push the condenser unit back into position in its housing.
- Turn the lever down to the horizontal position, making sure that the hook on the lever clicks into the groove.

When replacing the inner cover after cleaning, ensure that the rubber seal fits correctly into the groove.

- Replace the inner cover making sure the hooks locate correctly. Hold it at an angle and push it gently downwards.
- Then turn the lever upwards into the horizontal position to lock the cover.
- Replace the service panel and press the upper edge until it clicks into position.

 It is important to ensure that both the condenser unit and the cover are correctly positioned and locked, otherwise water may leak from the dryer.









## Problem solving guide

With the help of the following notes minor faults in the performance of the appliance, some of which may result from incorrect operation, can be put right without contacting the Service Department.

 Repair work to electrical appliances should only be carried out by a suitably qualified person in strict accordance with current local and national safety regulations. Repairs and other work by unqualified persons could be dangerous. The manufacturer cannot be held liable for unauthorised work.

### Check and fault messages

Problem	Possible cause	Remedy
<p>- appears in the display.</p> <p>The <i>Low temperature</i> indicator light is flashing.</p>	The electronic system lock is activated.	You will need to deactivate the system lock before the dryer can be used (see "Electronic system lock").
<p>The programme stops and  and <i>Finish</i> appear in the display.</p> <p>The buzzer sounds.</p>	<p>This is not a fault.</p> <p>The electronic unit has recognised that there is no laundry or insufficient laundry in the drum and cancelled the programme. Drying individual garments or items which are already dry can also cause the programme to be cancelled.</p>	<p>Use the <i>Warm air</i> programme for drying individual items.</p> <ul style="list-style-type: none"> <li>– Open and shut the door.</li> </ul>
<p>The programme stops.</p> <p>The buzzer sounds.</p> <p><i>Cooling down</i> or <i>Finish</i> may also flash in the display.</p>	No obvious cause.	<ul style="list-style-type: none"> <li>– Switch the dryer off and back on again.</li> <li>– Then start the programme again.</li> </ul> <p>If this problem happens again, there is a fault. Contact Miele.</p>
<p>Bars are flashing at the end of the programme:</p> <p>.........</p>	The programme has finished but the laundry is still being cooled down.	You can either unload the drum and leave the laundry to cool at room temperature or leave it in the dryer to continue cooling.

## Problem solving guide

Problem	Possible cause	Remedy
<p><b>The <i>Clean out airways</i> indicator light comes on.</b></p>	<p>The dryer is not working efficiently or economically. Possible cause: the filters are clogged with fluff or with detergent residues.</p>	<ul style="list-style-type: none"> <li>– Cleaning the filters is usually all that is required. However, if the reminder does not go out after you have cleaned the filters, then also check all the possible causes described under "The drying process goes on too long or even switches off".</li> </ul> <p><b>To switch off this reminder:</b></p> <ul style="list-style-type: none"> <li>– Open and shut the door with the dryer switched on.</li> </ul>
		<p>The <i>Clean out airways</i> indicator light can be deactivated (see "Programmable functions").</p>
<p><b>The programme stops and the <i>Clean out airways</i> indicator light comes on. The buzzer sounds.</b></p>	<p>See above for possible causes and their remedies.</p>	<p><b>To switch off this warning:</b></p> <ul style="list-style-type: none"> <li>– Open and shut the door with the dryer switched on.</li> <li>– Then start the programme again.</li> <li>– If this problem happens again, contact Miele.</li> </ul>
<p><b>The <i>Empty container</i> indicator light comes on. The buzzer sounds.</b></p>	<p>The condensed water container is full or there is kink in the drain hose.</p>	<ul style="list-style-type: none"> <li>– Empty out the condensed water container.</li> <li>– Check the drain hose.</li> </ul> <p><b>To switch off this warning:</b></p> <ul style="list-style-type: none"> <li>– Open and shut the door with the dryer switched on.</li> </ul>

## Problem solving guide

Problem	Possible cause	Remedy
<b>The <i>Start/Stop</i> button is flashing slowly and the display is dark.</b>	The dryer is in Standby mode. This is quite normal and not indicative of any fault.	See "Programmable functions".
<b>Sometimes a programme cannot be started and the corresponding programme indicator light does not light up.</b>	No obvious cause.	<ul style="list-style-type: none"><li>– Switch the dryer off and back on again.</li><li>– Select one of the programmes that would not start.</li><li>– If it still will not start, there is a fault. Contact the Miele Service Department.</li></ul>
<b>The <i>Start/Stop</i> button flashes on and off.</b>	The flashing indicates that a programme can be started.	After the programme has started, the flashing will change to a constant light.

## Problem solving guide

<b>An unsatisfactory drying result</b>		
<b>Problem</b>	<b>Possible cause</b>	<b>Remedy</b>
<b>The laundry is not sufficiently dry.</b>	The load consisted of different fabrics.	<ul style="list-style-type: none"><li>– Finish drying using the <i>Warm air</i> programme.</li><li>– Select a different programme next time *.</li></ul>
<b>Items made of synthetic fibres are charged with static electricity after drying.</b>	Synthetic fibres tend to attract static charge.	Static charge can be reduced by adding a fabric conditioner to the final rinse in the washing programme or a fabric conditioner sheet to the load when drying.
<b>There is a build-up of fluff.</b>	Fluff is principally the result of friction when garments are being worn and to some extent when they are being washed. Machine drying does not affect the lifetime of the fabric.	Fluff is collected by the fluff filters and can be removed easily (see "Cleaning and care").

\* You can alter the drying levels for some programmes (see "Programmable functions" at the the end of this booklet).

<b>Other problems</b>		
<b>Problem</b>	<b>Possible cause</b>	<b>Remedy</b>
<b>The drying process goes on too long or even switches off.</b>	In some circumstances, the <i>Clean out airways</i> indicator light still comes on, even though the filters are clean.	Please check all the possible causes and switch the dryer off and then back on again.
	Ventilation to and from the dryer may be insufficient, e.g. because it is installed in a room which is too small. This can cause the temperature in the room to rise sharply.	Open a door or window while the dryer is in operation for increased air flow.
	The vents below the door are blocked.	– Remove any objects that are blocking the vents.
	The fluff filters are clogged up with fluff or were still wet when they were replaced.	– Remove any fluff. – The fluff filters must be completely dry.
	Detergent residues, hair and fine fibres can block the condenser unit.	Check the condenser unit from time to time and clean it if necessary.
	The laundry has not been spun sufficiently.	Make sure that your laundry is thoroughly spun at the appropriate spin speed in the washing machine.
	The tumble dryer has been overloaded.	Do not exceed the maximum load for the programme selected.
	Metallic components, e.g. zips have prevented the dryer from registering the correct moisture level in the laundry.	– Open zips next time. If the problem occurs again, dry garments with long zips using the <i>Warm air</i> programme (timed drying).

# Problem solving guide

Problem	Possible cause	Remedy
<p><b>Water leaks from the dryer after the condenser unit has been cleaned.</b></p>	<ul style="list-style-type: none"> <li>- The inner cover of the condenser unit has not been locked properly and/or the condenser unit has not been positioned correctly.</li> <li>- Fluff has collected in the condenser unit housing.</li> </ul>	<ul style="list-style-type: none"> <li>- Ensure that the condenser unit is positioned correctly and lock the inner cover.</li> <li>- Check the rubber seals.</li> <li>- Use a cloth to remove any visible fluff from the inside of the condenser unit housing.</li> </ul>
<p><b>The programme does not start.</b></p>	<p>No obvious cause.</p>	<ul style="list-style-type: none"> <li>- Is the dryer switched on?</li> <li>- Is the plug correctly inserted into the socket and switched on?</li> <li>- Is the door closed properly?</li> <li>- Has the fuse or circuit breaker tripped?</li> </ul>
<p><b>Power cut.</b></p>	<p>A programme which was running previously will continue automatically when power is restored to the tumble dryer as long as the Cooling down phase had not been reached.</p>	
<p><b>The interior drum lighting does not come on.</b></p>	<p>The lighting switches off automatically (to save energy).</p>	<ul style="list-style-type: none"> <li>- Switch the dryer off and then on again.</li> <li>- If the lamp needs to be replaced, follow the instructions in "Changing the lamp".</li> </ul>

### Changing the lamp

Disconnect the tumble dryer from the mains electricity supply.

- Open the door.

You will find the interior light cover at the top of the drum aperture.

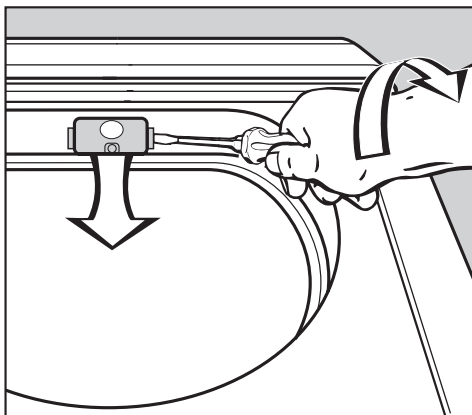

- Insert a suitable tool, such as a wide bladed screwdriver, under the side edge of the light cover as illustrated.
- Apply a little pressure and whilst doing so turn your wrist in the direction of the arrow to open the cover.

The cover will open downwards.

The temperature resistant lamp should only be ordered from your Miele Dealer or the Miele Spare Parts Department.

The light specification and maximum wattage is stated on the data plate and on the light cover.

- Turn the light anti-clockwise to remove.
- Replace the lamp.
- To close the cover push it upwards and press it on the left and right until you hear it click into position.

⚠ Ensure that it is fitted into position securely, as any moisture could cause a short circuit.

## After Sales service

---

### Repairs

In the event of any faults which you cannot remedy yourself, please contact

- your Miele dealer or
- the Miele Service Department (see back cover for contact details).

When contacting your dealer or the Service Department, please quote the model and serial number of your appliance, both of which are shown on the data plate. This is visible when you open the door.

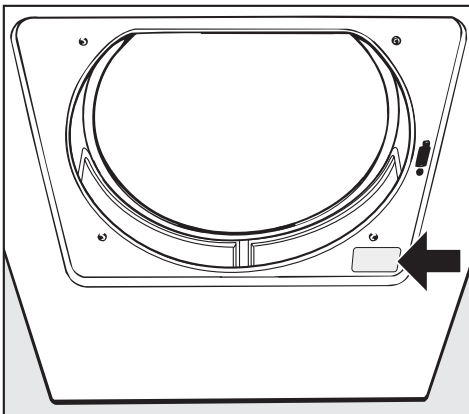

N.B. A call-out charge will be applied for service visits where the problem could have been resolved as described in these instructions.

### Future updates (PC)

The indicator or check light marked **PC** on the fascia panel is the interface used by the Miele service technicians during service work for testing purposes and for updating the appliance's programme data.

### Appliance guarantee

In the U.K. your appliance is guaranteed for 2 years from the date of purchase. However you must activate your cover by calling 0845 365 6640 or registering online at [www.miele.co.uk](http://www.miele.co.uk).

For information on the appliance guarantee specific to your country please contact Miele. See back cover for contact details.

### Optional accessories

Optional accessories for this dryer are available from your Miele Dealer, the Miele Spare Parts Department or via the internet at [www.miele-shop.com](http://www.miele-shop.com).

Please note that telephone calls may be monitored and recorded for training purposes.



## Front view

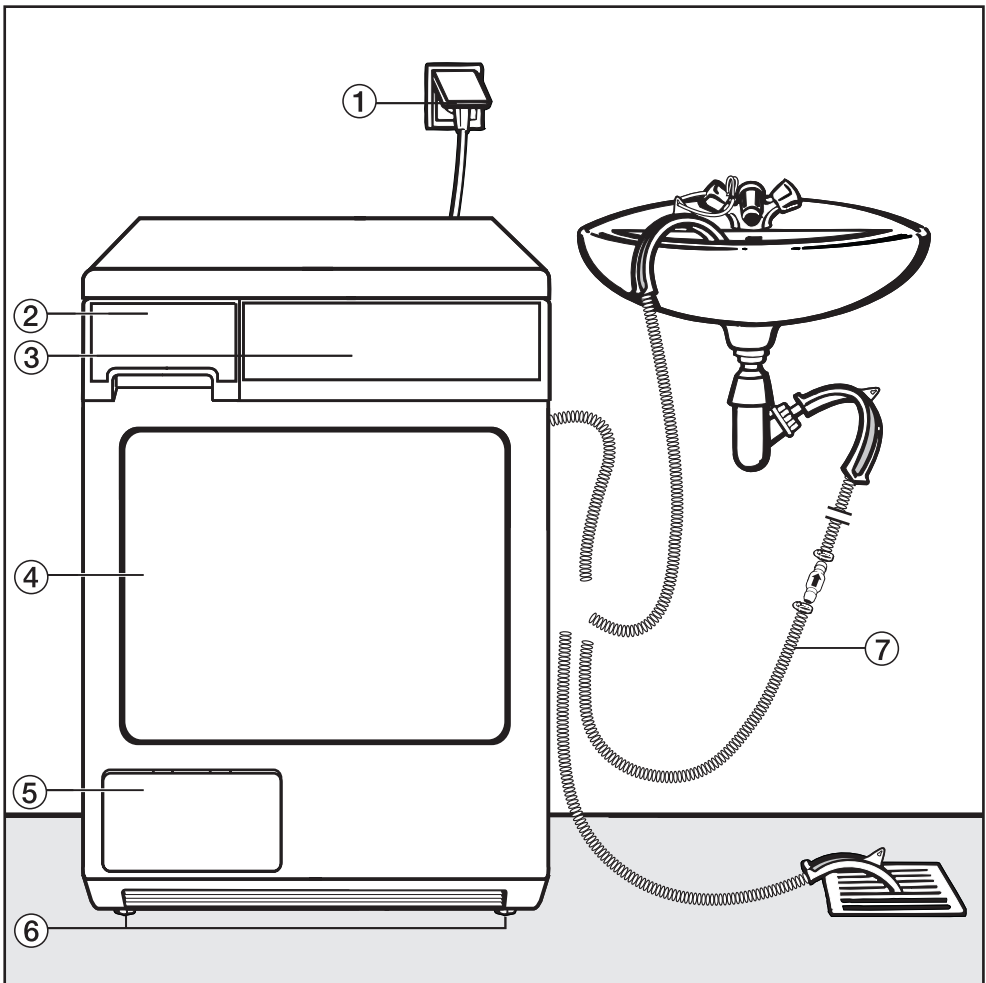

- ① Mains connection cable
- ② Condensed water container
- ③ Control panel
- ④ Door
- ⑤ Service panel for condenser unit
- ⑥ Four height-adjustable screw feet
- ⑦ External drainage options (e.g. via wash basin, wash basin drain outlet, or gully. See "External condensed water outlet").

# Installation

## Rear view

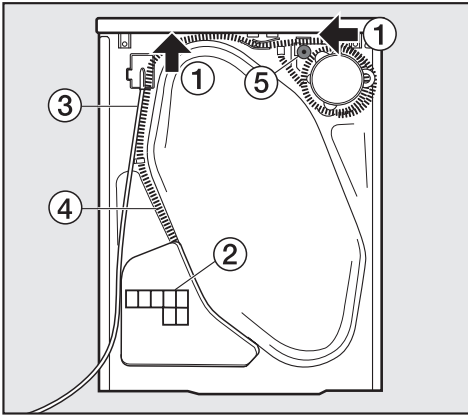

- ① Protruding lid for holding when moving the dryer (see arrows)
- ② Air inlet vent for cooling the condenser unit
- ③ Mains connection cable
- ④ Hose for external drainage of condensed water
- ⑤ Accessories for connection to a sink drain outlet

## Installation site

 Make sure the dryer door can be opened without hindrance after installation.

## Transporting the dryer to its installation site

When moving the dryer, hold it by the lid where it protrudes to the rear. To manoeuvre the dryer out of its packing case to its installation site hold it by the **front feet and the base of the lid**.

## Building under a continuous worktop / in a kitchen run

 A **building-under kit\*** with a coverplate to replace the appliance lid is required. It must be fitted by a suitably qualified person to ensure electrical safety.

N.B. If you wish to push your appliance under a worktop and there is space to do this without removing the lid the building-under kit is not necessary. Otherwise it is essential.

- The building-under kit is supplied with its own installation instructions.
- N.B. When built-under drying times may be longer.
- The electrical socket must be located in an accessible position near the appliance.

With niche heights of:

- 830-840 mm, longer screw feet\* are required.
- 870-885 / 915-930 mm, one or two raising kits\* are required.

\* Miele accessory available to order

## Replacing the lid

If the lid has been removed in order to fit a coverplate, ensure that, if the lid is ever replaced, it fits securely into the rear holders. Otherwise, it is not properly secure for transport.

## Levelling the appliance

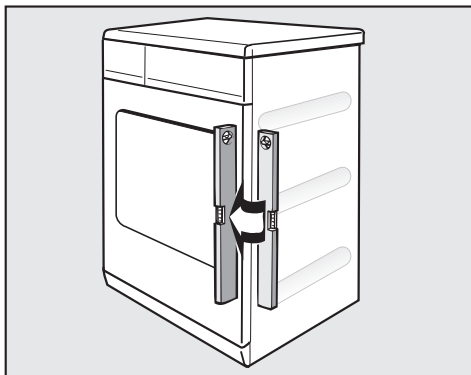

The dryer must be perfectly level to ensure safe and proper operation.

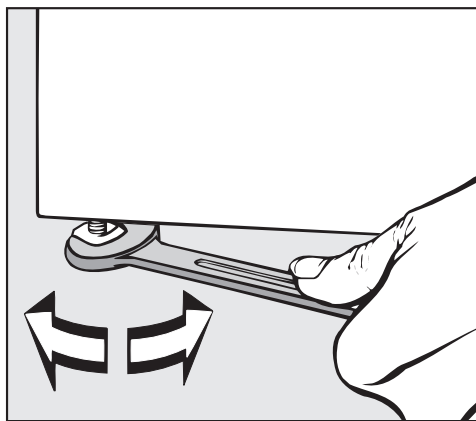

- The screw feet can be adjusted to compensate for any unevenness in the floor.

⚠ The air inlet and outlet vents on the front of the dryer must not be covered as this would prevent sufficient ventilation for cooling the condenser unit.

⚠ Do not block the gap between the bottom of the tumble dryer and the floor with plinth facings, deep pile carpet etc. This would hinder a sufficient flow of air to the dryer.

## Room ventilation

The air which is taken in when the dryer is in operation is blown out of the front of the dryer and warms up the air in the room. It is very important to ensure adequate ventilation, e.g. by opening a window. Otherwise drying times may be longer.

## Washer-dryer stack

The tumble dryer can also be combined with a Miele washing machine in a washer-dryer stack. The appropriate "WTV" stacking kit (available to order) to match your dryer is required.

⚠ Stacking kits must only be installed by a suitably qualified fitter.

## Before moving the tumble dryer again (e.g. when moving house)

After each use a small quantity of condensed water will collect in the area around the pump. This water can run out if the dryer is tipped up when it is being moved. It is a good idea to run the *Warm air* programme for approximately 1 minute before moving it. Any remaining condensed water will then be fed into the condensed water container or out through the drain hose.

# Installation

## External condensed water outlet

### General notes

When drying is in progress, condensed water is pumped into the condensed water container through the drain hose at the back of the dryer. The condensed water can also be drained off directly if the tumble dryer is installed near a sink, drain outlet etc. so that the condensed water container does not have to be emptied.

Drain hose length . . . . . 1.50 m  
Maximum delivery head . . . . . 1.50 m  
Maximum drain hose length . . . . 4.00 m

**⚠** If the on-site water drainage system is not fitted with a non-return valve or an appropriate air gap, one must be fitted to prevent the risk of back-flow. (See "Installation conditions requiring a non-return valve").

The following optional accessories are available:

- an extension hose
- a non-return valve kit for connection to an external condensed water outlet (includes an extension hose). Maximum delivery head with non-return valve fitted: 1.00 m

### Arranging the drain hose

**⚠** Do not pull on the drain hose and do not stretch it or allow it to become kinked as it could get damaged.

- There will be a small amount of residual water in the drain hose. Have a container ready to collect this.

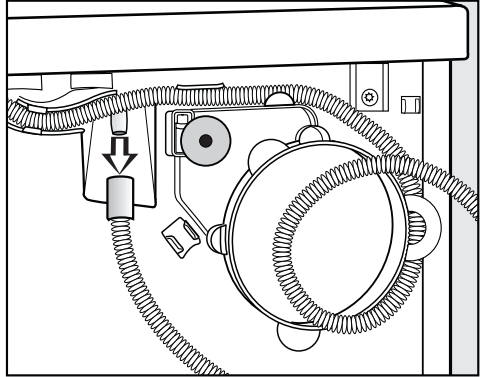

- Pull the hose off its connection (see arrow).
- Allow any residual water to run into the container.
- Unwind the hose and pull it carefully out of the holders.

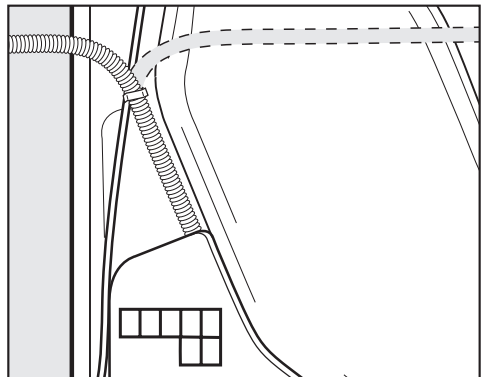

- Position the hose to the right or left hand side as necessary.

Leave the hose in the middle holder to prevent it from becoming kinked inadvertently.

## External drainage via a sink or gully

- See "Front view" illustration.

 If you want to drain the water off into a sink you will need to secure the hose carefully, e.g. by tying it to a tap to make sure it cannot slip during use. Otherwise there is a risk of overflowing water which could cause damage.

- Use the bow-shaped guide to prevent the drain hose from becoming kinked.

## Installation conditions requiring a non-return valve

 Certain installation conditions require the fitting of a **non-return valve for external water connection** (available as an optional accessory). A non-return valve will prevent the risk of back-flow out of the dryer which could cause damage.

A non-return valve is required:

- If the tumble dryer is connected to a sink drain outlet (see the following section).
- If the tumble dryer is connected to a drainage system **already in use** by another appliance, e.g. a dishwasher or washing machine.

## Example: Connection to a sink drain outlet

The drain hose with non-return valve fitted can be connected directly to a suitable sink drain outlet.

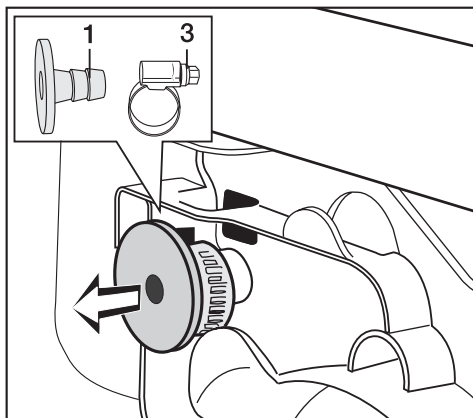

- Remove the following from the back of the dryer at the top:  
Adapter **1** and hose clip **3** behind it.

# Installation

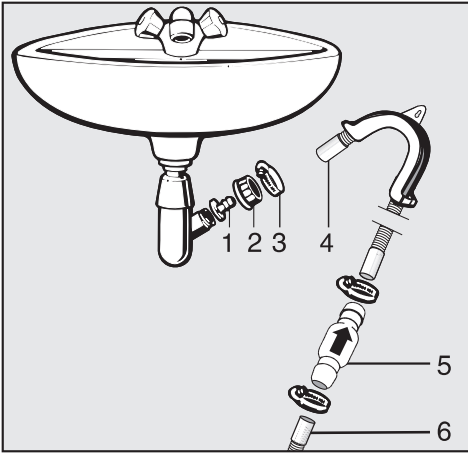

- 1 Adapter
- 2 Nut
- 3 Hose clip
- 4 End of the hose
- 5 Non-return valve
- 6 Tumble dryer drain hose

- Fit adapter **1** to the sink drain outlet using nut **2**.

If this nut has a flat disc in it you should take the disc out first.

- Attach the end of hose **4** to adapter **1**.
- Use a screwdriver to tighten hose clip **3** up close to the nut.

 Non-return valve **5** has to be fitted with the arrow pointing in the direction of flow (i.e. towards the sink). Otherwise water will not drain out of the appliance.

- Fit non-return valve **5** to tumble dryer drain hose **6** (make sure it is fitted in the correct direction - see arrow on non-return valve).
- Secure the non-return valve using hose clips.

## Electrical connection U.K.

All electrical work should be carried out by a suitably qualified and competent person, in strict accordance with current national and local safety regulations (BS 7671 in the UK).

Ensure power is not supplied to the appliance until after installation work has been carried out.

The appliance is supplied with a mains cable with moulded plug ready for connection to a 230-240V mains supply. Please ensure the connection data quoted on the data plate match the household mains supply.

Connection should be made via a suitable switched socket which is easily accessible after installation.

For extra safety it is advisable to protect the appliance with a suitable residual current device (RCD). Contact a qualified electrician for advice.

Do not connect via an extension lead. Extension leads do not guarantee the required safety of the appliance (e.g. danger of overheating).

## Non-rewireable plugs BS 1363

The fuse cover must be refitted when changing the fuse, and if the fuse cover is lost, the plug must not be used until a suitable replacement is obtained. The colour of the correct replacement cover is that of the coloured insert in the base of the plug, or the colour that is embossed in words on the base of the plug (as applicable to the design of plug fitted).

Replacement fuses should be ASTA approved to BS 1362 and have the correct rating. Replacement fuses and fuse covers may be purchased from your local electrical supplier.

**WARNING: THIS APPLIANCE  
MUST BE EARTHED**

# Consumption data

	Load <sup>1</sup>	Final spin speed in a domestic washing machine	Residual moisture	Energy	Duration
	kg	rpm	%	kWh	Minutes
<b>Cottons Normal<sup>2</sup></b>	7.0	1000	60	4.14	109
	3.5	1000	60	2.28	65
<b>Cottons Normal</b>	7.0	1200	53	3.75	100
	7.0	1400	50	3.55	95
	7.0	1600	44	3.15	86
	7.0	1800	43	3.10	84
<b>Cottons Normal + Low temperature</b>	7.0	1000	60	4.20	175
<b>Cottons Hand iron</b>	7.0	1000	60	3.10	89
	7.0	1200	53	2.75	79
	7.0	1400	50	2.55	74
	7.0	1600	44	2.20	65
	7.0	1800	43	2.10	63
<b>Minimum iron Normal</b>	3.5	1200	40	1.40	45
<b>Minimum iron Normal + Low temperature</b>	3.5	1200	40	1.50	73
<b>Minimum iron Hand iron</b>	3.5	1200	40	1.20	39
<b>Automatic plus Normal</b>	5.0	800	50	2.70	114
<b>Shirts Normal</b>	2.0	600	60	1.40	59
<b>Delicates Normal</b>	2.5	700	50	1.55	116
<b>Proofing Normal</b>	2.5	800	50	1.85	96
<b>Denim Normal</b>	3.0	900	60	2.40	119
<b>Express Normal</b>	3.5	1000	60	2.20	69
<b>Gentle smoothing</b>	1.0	1000	60	0.75	32
<b>Woolens handcare</b>	2.0	1000	50	0.15	4

<sup>1</sup> Weight of dry laundry

<sup>2</sup> Test programme in accordance with Regulation 392/2012/EU for energy labelling measured in accordance with EN 61121.

All data was calculated using EN 61121 unless otherwise stated.

## Notes for test institutes:

Before testing in accordance with EN 61121, dry a 3 kg load of cotton laundry with 70% residual moisture as per the above standard using the Cottons Normal programme without any extra options.

**Consumption data can vary from the nominal values given above depending on the size of the load, types of textiles, residual moisture levels after spinning, fluctuations in the electricity supply and any extra options selected.**



## Technical data

Height	850 mm
Width	595 mm
Depth	587 mm
Depth with door open	1062 mm
Height for building under	820 mm
Width for building under	600 mm
Depth for building under	600 mm
Suitable for pushing under a worktop	yes
Suitable for stacking	yes
Weight	51 kg
Drum volume	111 l
Maximum capacity	7 kg dry weight
Capacity of condensed water container	approx. 4.2 l
Drain hose length	1.5 m
Maximum delivery head	1.5 m
Maximum drain hose length	4 m
Length of connection cable	2 m
Voltage	] see data plate
Connected load	
Fuse rating	
Lamp wattage	
Test certificates awarded	
Energy consumption	see "Consumption data"

# Programmable functions

## Altering the residual moisture level in the Cottons programme

The tumble dryer is designed to dry effectively using as little energy as possible.

However, if you require the laundry to be drier or damper, you can reduce or increase the default residual moisture in the Cottons programme.

Follow the steps (1, 2, 3 ...) to programme and store in memory.

Before you begin, ensure that:

- The tumble dryer is switched off.
- The door is closed.

1 Press the *Start/Stop* button and keep it pressed in whilst carrying out steps 2-3.

2 Switch the dryer on.

Wait until the *Start/Stop* button lights up constantly . . .

3 . . . and then release the *Start/Stop* button.

- The *Low temperature* indicator light will flash once briefly.

A **number** to show which option is selected will appear in the display alternating with the letter *P*.

0 **Increased residual moisture. Laundry damper.**

1 **Standard residual moisture (factory default setting)**  
(the *Automatic plus* indicator light will also flash once).

2 **Reduced residual moisture. Laundry drier.**  
(the *Automatic plus* indicator light will also flash twice).

4 Pressing the *Start/Stop* button switches between the options.

5 Switch the dryer off.

The setting you have selected is now stored in memory. You can change it again at any time.

**To check the setting:**

■ Carry out steps 1 to 3.

■ Switch the dryer off after step 3.

## Altering the residual moisture level in the Minimum iron programme

The tumble dryer is designed to dry effectively using as little energy as possible.

However, if you require the laundry to be drier or damper, you can reduce or increase the default residual moisture in the Minimum iron programme.

Follow the steps (1, 2, 3 ...) to programme and store in memory.

Before you begin, ensure that:

- The tumble dryer is switched off.
- The door is closed.

1 Press the *Start/Stop* button and keep it pressed in whilst carrying out steps 2–3.

2 Switch the dryer on.

Wait until the *Start/Stop* button lights up constantly . . .

3 . . . and then release the *Start/Stop* button.

4 Press the *Low temperature* button once.

- The *Low temperature* indicator light will flash twice briefly.

A **number** to show which option is selected will appear in the display alternating with the letter *P*.

0 **Increased residual moisture. Laundry damper.**

1 **Standard residual moisture (factory default setting)**  
(the *Automatic plus* indicator light will also flash once).

2 **Reduced residual moisture. Laundry drier.**

(the *Automatic plus* indicator light will also flash twice).

5 Pressing the *Start/Stop* button switches between the options.

6 Switch the dryer off.

The setting you have selected is now stored in memory. You can change it again at any time.

**To check the setting:**

■ Carry out steps 1 to 4.

■ Switch the dryer off after step 4.

# Programmable functions

## Anti-crease

Anti-crease helps prevent creasing, if laundry is not normally removed immediately after the end of a programme.

The anti-crease function

- is activated when the tumble dryer is delivered. You can shorten the duration of the anti-crease phase or deactivate it if wished.
- is used in all programmes except *Woollens handcare*.
- should be left activated.

**Follow the steps (1, 2, 3 ...) to programme and store in memory.**

**Before you begin, ensure that:**

- The tumble dryer is switched off.
- The door is closed.

**1** Press the *Start/Stop* button and keep it pressed in whilst carrying out steps **2-3**.

**2** Switch the dryer on.

Wait until the *Start/Stop* button lights up constantly . . .

**3** . . . and then release the *Start/Stop* button.

**4** Press the *Low temperature* button twice.

- The *Low temperature* indicator light will flash 3 times briefly.

A **number** to show which option is selected will appear in the display alternating with the letter *P*.

### **0** Anti-crease off

#### **1** 1 hour anti-crease

(the *Automatic plus* indicator light will also flash once).

#### **2** 2 hours anti-crease **(factory default setting)**

(the *Automatic plus* indicator light will also flash twice).

**5** Pressing the *Start/Stop* button switches between the options.

**6** Switch the dryer off.

The setting you have selected is now stored in memory. You can change it again at any time.

### **To check the setting:**

■ Carry out steps **1** to **4**.

■ Switch the dryer off after step **4**.

## Altering the volume of the buzzer

The buzzer has two volumes.

Follow the steps (1, 2, 3 ...) to programme and store in memory.

Before you begin, ensure that:

- The tumble dryer is switched off.
- The door is closed.

1 Press the *Start/Stop* button and keep it pressed in whilst carrying out steps 2–3.

2 Switch the dryer on.

Wait until the *Start/Stop* button lights up constantly . . .

3 . . . and then release the *Start/Stop* button.

4 Press the *Low temperature* button three times.

- The *Low temperature* indicator light will flash four times briefly.

A **number** to show which option is selected will appear in the display alternating with the letter *P*.

▣ **Normal buzzer**  
(factory default setting)

/ **Loud buzzer**  
(the *Automatic plus* indicator light will also flash)

5 Pressing the *Start/Stop* button switches between the options.

6 Switch the dryer off.

The setting you have selected is now stored in memory. You can change it again at any time.

**To check the setting:**

■ Carry out steps 1 to 4.

■ Switch the dryer off after step 4.

# Programmable functions

## Altering the standard drying level in the Automatic plus programme

The tumble dryer is designed to dry effectively using as little energy as possible.

However, if you require the laundry to be drier or damper, you can reduce or increase the default residual moisture in the Automatic plus programme.

Follow the steps (1, 2, 3 ...) to programme and store in memory.

Before you begin, ensure that:

- The tumble dryer is switched off.
  - The door is closed.
  - 1 Press the *Start/Stop* button and keep it pressed in whilst carrying out steps 2-3.
  - 2 Switch the dryer on.
- Wait until the *Start/Stop* button lights up constantly . . .
- 3 . . . and then release the *Start/Stop* button.
  - 4 Press the *Low temperature* button four times.
- The *Low temperature* indicator light will flash six times briefly.

A **number** to show which option is selected will appear in the display alternating with the letter *P*.

0 **Increased residual moisture. Laundry damper.**

1 **Standard residual moisture (factory default setting)**  
(the *Automatic plus* indicator light will also flash once).

2 **Reduced residual moisture. Laundry drier.**

(the *Automatic plus* indicator light will also flash twice).

5 Pressing the *Start/Stop* button switches between the options.

6 Switch the dryer off.

The setting you have selected is now stored in memory. You can change it again at any time.

**To check the setting:**

- Carry out steps 1 to 4.
- Switch the dryer off after step 4.

## Extending the cooling down time

The cooling down phase which takes place before the end of a programme can be extended by 5 or 10 minutes, if required. This makes the garments easier to handle.

The cooling down time can only be extended for programmes with drying levels.

**Follow the steps (1, 2, 3 ...) to programme and store in memory.**

**Before you begin, ensure that:**

- The tumble dryer is switched off.
- The door is closed.

- 1 Press the *Start/Stop* button and keep it pressed in whilst carrying out steps 2-3.
- 2 Switch the dryer on.

Wait until the *Start/Stop* button lights up constantly . . .

- 3 . . . and then release the *Start/Stop* button.
  - 4 Press the *Low temperature* button five times.
- The *Low temperature* indicator light will flash seven times briefly.

A **number** to show which option is selected will appear in the display alternating with the letter *P*.

0 **Cooling down time not extended (factory default setting)**

1 **Cooling down time extended by five minutes**

(the *Automatic plus* indicator light will also flash once).

2 **Cooling down time extended by ten minutes**

(the *Automatic plus* indicator light will also flash twice).

5 Pressing the *Start/Stop* button switches between the options.

6 Switch the dryer off.

The setting you have selected is now stored in memory. You can change it again at any time.

**To check the setting:**

- Carry out steps 1 to 4.
- Switch the dryer off after step 4.

# Programmable functions

---

## Standby

To save energy, the display and the programme sequence/check lights go out after 10 minutes and the *Start/Stop* button starts flashing slowly.

### To come out of standby mode

- Turn the programme selector or press a button. Neither will have any effect if a programme is running.

## On

The standby function is activated and the display and programme sequence/check lights will go out after 10 minutes:

- if a programme is not selected after the dryer has been switched on.
- after a programme has started.

They will, however, come on for 10 minutes after a delay start time has counted down, at the end of the programme or the end of the anti-crease phase.

The buzzer (if selected ) will sound for 10 minutes at the end of the programme.

## Factory default. Not in current programme

As described under "On". However, the display and programme sequence/check lights will stay on after the programme has started and remain visible during the programme.

## Off

The display and programme sequence/check lights will stay on while the dryer is switched on.

## Follow the steps (1, 2, 3 ...) to programme and store in memory.

- See next page.



## Before you begin, ensure that:

- The tumble dryer is switched off.
- The door is closed.

1 Press the *Start/Stop* button and keep it pressed in whilst carrying out steps 2-3.

2 Switch the dryer on.

Wait until the *Start/Stop* button lights up constantly . . .

3 . . . and then release the *Start/Stop* button.

4 Press the *Low temperature* button six times.

- The *Low temperature* indicator light will flash 8 times briefly.

A **number** to show which option is selected will appear in the display alternating with the letter *P*.

## 1 On

### 1 Factory default setting. Not in current programme

(the *Automatic plus* indicator light will also flash once).

## 2 Off

(the *Automatic plus* indicator light will also flash twice).

5 Pressing the *Start/Stop* button switches between the options.

6 Switch the dryer off.

The setting you have selected is now stored in memory. You can change it again at any time.

## To check the setting:

- Carry out steps 1 to 4.
- Switch the dryer off after step 4.

# Programmable functions

## Memory function

The electronics will memorise any extra options selected for a programme. The duration selected for the Warm air or Cool air timed drying programmes will also be stored in memory.

These settings will be selected automatically the next time the programme is chosen. You can either accept these or change them by pressing the appropriate button.

**Follow the steps (1, 2, 3 ...) to programme and store in memory.**

**Before you begin, ensure that:**

- The tumble dryer is switched off.
- The door is closed.

1 Press the *Start/Stop* button and keep it pressed in whilst carrying out steps 2–3.

2 Switch the dryer on.

Wait until the *Start/Stop* button lights up constantly . . .

3 . . . and then release the *Start/Stop* button.

4 Press the *Low temperature* button seven times.

- The *Low temperature* indicator light will flash 9 times briefly.

A **number** to show which option is selected will appear in the display alternating with the letter *P*.

0 **Memory deactivated**  
(factory default setting)

1 **Memory activated**  
(the *Automatic plus* indicator light will also flash)

5 Pressing the *Start/Stop* button switches between the options.

6 Switch the dryer off.

The setting you have selected is now stored in memory. You can change it again at any time.

**To check the setting:**

■ Carry out steps 1 to 4.

■ Switch the dryer off after step 4.

## Clean out airways indicator

Fluff should be removed after drying. The *Clean out airways* indicator will remind you to clean the filters when a certain amount of fluff has collected in the filters. You can decide at what level of fluff this reminder should be given.

You will have an idea of how often this should be done after a few drying programmes.

**Follow the steps (1, 2, 3 ...) to programme and store in memory.**

**Before you begin, ensure that:**

- The tumble dryer is switched off.
- The door is closed.

1 Press the *Start/Stop* button and keep it pressed in whilst carrying out steps 2–3.

2 Switch the dryer on.

Wait until the *Start/Stop* button lights up constantly . . .

3 . . . and then release the *Start/Stop* button.

4 Press the *Low temperature* button eight times.

- The *Low temperature* indicator light will flash on and off slowly once.

A **number** to show which option is selected will appear in the display alternating with the letter *P*.

0 **Clean out airways indicator light deactivated**

1 **Clean out airways indicator light comes on when there is a heavy build-up of fluff**

(the *Automatic plus* indicator light will also flash once).

2 **Factory default setting**

(the *Automatic plus* indicator light will also flash twice).

3 **Clean out airways indicator light comes on when there is only a light build-up of fluff**

(the *Automatic plus* indicator light will also flash three times).

5 Pressing the *Start/Stop* button switches between the options.

6 Switch the dryer off.

The setting you have selected is now stored in memory. You can change it again at any time.

**To check the setting:**

■ Carry out steps 1 to 4.

■ Switch the dryer off after step 4.

# Programmable functions

## Keypad tone

An audible tone sounds each time a button is pressed.

Follow the steps (1, 2, 3 ...) to programme and store in memory.

Before you begin, ensure that:

- The tumble dryer is switched off.
- The door is closed.

1 Press the *Start/Stop* button and keep it pressed in whilst carrying out steps 2-3.

2 Switch the dryer on.

Wait until the *Start/Stop* button lights up constantly . . .

3 . . . and then release the *Start/Stop* button.

4 Press the *Low temperature* button nine times.

- The *Low temperature* indicator light will flash on and off slowly once and then on and off quickly once.

A **number** to show which option is selected will appear in the display alternating with the letter *P*.

□ **Keypad tone deactivated**  
(factory default setting)

/ **Keypad tone activated**  
(the *Automatic plus* indicator light will also flash)

5 Pressing the *Start/Stop* button switches between the options.

6 Switch the dryer off.

The setting you have selected is now stored in memory. You can change it again at any time.

**To check the setting:**

■ Carry out steps 1 to 4.

■ Switch the dryer off after step 4.

## Adjusting the dryer's electronics for very soft water

 In some areas of the UK, water is extremely soft which can affect the sensitivity of the control electronics. If the dryer is installed in an area of very soft water, you should contact your local water supplier for information and advice regarding water hardness and water conductivity. If the water conductivity is less than 150 µS, the following programmable function will need to be activated.

Important. This programmable function should not be activated if, despite the water being extremely soft (as would be the case if a water softener were used), its conductivity is greater than 150 µS.

**Follow the steps (1, 2, 3 ...) to programme and store in memory.**

**Before you begin, ensure that:**

- The tumble dryer is switched off.
- The door is closed.

**1** Press the *Start/Stop* button and keep it pressed in whilst carrying out steps **2-3**.

**2** Switch the dryer on.

Wait until the *Start/Stop* button lights up constantly . . .

**3** . . . and then release the *Start/Stop* button.

**4** Press the *Low temperature* button ten times.

- The *Low temperature* indicator light will flash on and off slowly once and then on and off quickly twice.

A **number** to show which option is selected will appear in the display alternating with the letter *P*.

**0 Factory default setting**

**1 Adjusted for very soft water**

(the *Automatic plus* indicator light will also flash)

**5** Pressing the *Start/Stop* button switches between the options.

**6** Switch the dryer off.

The setting you have selected is now stored in memory. You can change it again at any time.

**To check the setting:**

■ Carry out steps **1** to **4**.

■ Switch the dryer off after step **4**.

# Programmable functions

## Extending the range of the drying levels

You can extend the range of the drying levels for many of the programmes:

### **Machine iron+**

(drier than Machine iron).

### **Slightly dry**

(drier than Hand iron).

### **Normal+**

(drier than Normal).

This programmable function is only available for programmes with drying levels.

### Follow the steps (1, 2, 3 ...) to programme and store in memory.

#### Before you begin, ensure that:

- The tumble dryer is switched off.
- The door is closed.

1 Press the *Start/Stop* button and keep it pressed in whilst carrying out steps 2-3.

2 Switch the dryer on.

Wait until the *Start/Stop* button lights up constantly . . .

3 . . . and then release the *Start/Stop* button.

4 Press the *Low temperature* button eleven times.

- The *Low temperature* indicator light will flash on and off slowly once and then on and off quickly three times.

A **number** to show which option is selected will appear in the display alternating with the letter *P*.

#### ▣ **Factory default setting**

#### 1 **Drying level range extended**

(the *Automatic plus* indicator light will also flash).

5 Pressing the *Start/Stop* button switches between the options.

6 Switch the dryer off.

The setting you have selected is now stored in memory. You can change it again at any time.

#### To check the setting:

■ Carry out steps 1 to 4.

■ Switch the dryer off after step 4.

#### To select the extended drying level

■ Select a programme.

■ Press the drying level button repeatedly until one or two indicator lights come on.

– Indicator lights *Extra dry* and *Normal* = Normal+

– Indicator lights *Normal* and *Hand iron* = Slightly dry

– Indicator lights *Hand iron* and *Machine iron* = Machine iron+



## United Kingdom

Miele Co. Ltd.  
Fairacres, Marcham Road  
Abingdon, Oxon, OX14 1TW  
Tel: 0845 365 0555, Fax: 0845 365 0777  
Customer Contact Centre Tel: 0845 365 6600  
E-mail: [info@miele.co.uk](mailto:info@miele.co.uk)  
Internet: [www.miele.co.uk](http://www.miele.co.uk)

## Australia

Miele Australia Pty. Ltd.  
ABN 96 005 635 398  
1 Gilbert Park Drive, Knoxfield, VIC 3180  
Tel: 1300 464 353, Fax: (03) 9764 7149  
Internet: [www.miele.com.au](http://www.miele.com.au)

## China

Miele (Shanghai) Trading Ltd.  
1-3 Floor, No. 82 Shi Men Yi Road  
Jing' an District  
200040 Shanghai, PRC  
Tel: +86 21 6157 3500, Fax: +86 21 6157 3511  
E-mail: [mieleshanghai@cn.miele.com](mailto:mieleshanghai@cn.miele.com)  
Internet: [www.miele.cn](http://www.miele.cn)

## Miele (Hong Kong) Limited

41/F - 4101, Manhattan Place  
23 Wang Tai Road  
Kowloon Bay  
Hong Kong  
Tel: (852) 2610 1331, Fax: (852) 2610 1013  
Email: [mielehk@miele.com.hk](mailto:mielehk@miele.com.hk)

## India

Miele India Pvt. Ltd.  
Ground Floor, Copia Corporate Suites  
Plot No. 9, Jasola  
New Delhi - 110025  
Tel: 011-46 900 000, Fax: 011-46 900 001  
E-mail: [customercare@miele.in](mailto:customercare@miele.in), Internet: [www.miele.in](http://www.miele.in)

## Ireland

Miele Ireland Ltd.  
2024 Bianconi Avenue  
Citywest Business Campus, Dublin 24  
Tel: (01) 461 07 10, Fax: (01) 461 07 97  
E-Mail: [info@miele.ie](mailto:info@miele.ie), Internet: [www.miele.ie](http://www.miele.ie)

## Manufacturer: Miele & Cie. KG

Carl-Miele-Straße 29, 33332 Gütersloh, Germany

# Miele

## Malaysia

Miele Sdn Bhd  
Suite 12-2, Level 12  
Menara SapuraKencana Petroleum  
Solaris Dutamas No. 1, Jalan Dutamas 1  
50480 Kuala Lumpur, Malaysia  
Phone: +603-6209-0288  
Fax: +603-6205-3768

## New Zealand

Miele New Zealand Limited  
Unit L, 10-20 Sylvia Park Road  
Mt. Wellington, 1060, Auckland, NZ  
Tel: 0800 264 353, Fax: 0800 463 453  
Internet: [www.miele.co.nz](http://www.miele.co.nz)

## Singapore

Miele Southeast Asia  
Miele Pte. Ltd.  
163 Penang Road  
# 04 - 02/03 Winsland House II  
Singapore 238463  
Tel: +65 6735 1191, Fax: +65 6735 1161  
E-Mail: [infosea@miele.com.sg](mailto:infosea@miele.com.sg)  
Internet: [www.miele.sg](http://www.miele.sg)

## South Africa

Miele (Pty) Ltd  
63 Peter Place, Bryanston 2194  
P.O. Box 69434, Bryanston 2021  
Tel: (011) 875 9000, Fax: (011) 875 9035  
E-mail: [info@miele.co.za](mailto:info@miele.co.za)  
Internet: [www.miele.co.za](http://www.miele.co.za)

## United Arab Emirates

Miele Appliances Ltd.  
P.O. Box 11 47 82  
Gold & Diamond Park  
Sheikh Zayed Road  
Building 6 / Offices Nos. 6-214 to 6-220  
Dubai  
Tel: +971-4-341 84 44  
Fax: +971-4-341 88 52  
E-Mail: [info@miele.ae](mailto:info@miele.ae), Internet: [www.miele.ae](http://www.miele.ae)



## Free Manuals Download Website

<http://myh66.com>

<http://usermanuals.us>

<http://www.somanuals.com>

<http://www.4manuals.cc>

<http://www.manual-lib.com>

<http://www.404manual.com>

<http://www.luxmanual.com>

<http://aubethermostatmanual.com>

Golf course search by state

<http://golfingnear.com>

Email search by domain

<http://emailbydomain.com>

Auto manuals search

<http://auto.somanuals.com>

TV manuals search

<http://tv.somanuals.com>