

Miele

HONEYCOMB CARE

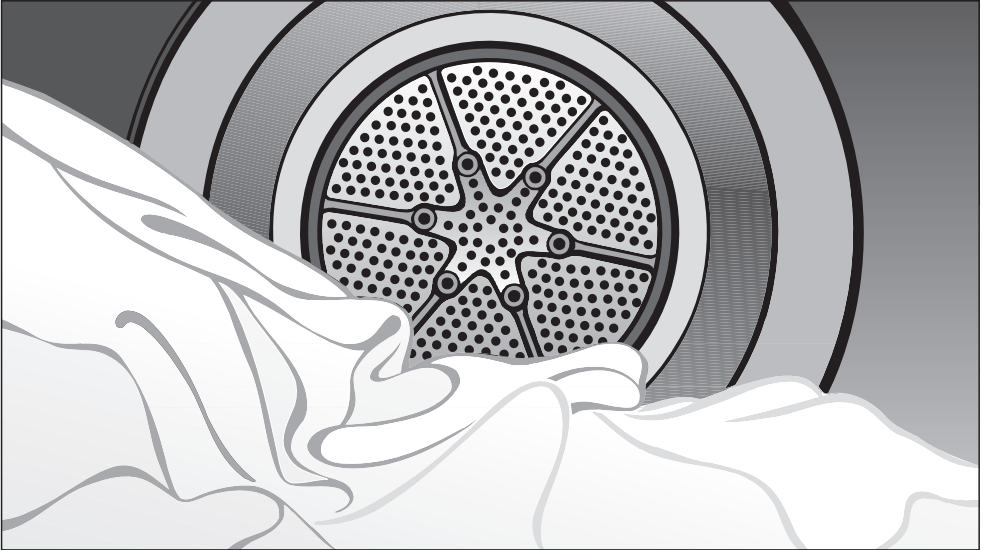

Operating instructions for condenser tumble dryer T 4662 C

To avoid the risk of accidents or damage to the machine it is **essential** to read these instructions before it is installed and used for the first time.



M.-Nr. 06 465 800

Caring for the environment

Disposal of the packing material

The transport and protective packing has been selected from materials which are environmentally friendly for disposal and can normally be recycled.

Ensure that any plastic wrappings, bags etc. are disposed of safely and kept out of the reach of babies and young children. Danger of suffocation!

Rather than just throwing these materials away, please ensure they are offered for recycling.

Disposal of your old appliance

Electrical and electronic appliances often contain materials which, if handled or disposed of incorrectly, could be potentially hazardous to human health and to the environment. They are, however, essential for the correct functioning of your appliance. Please do not therefore dispose of your appliance with your household waste.

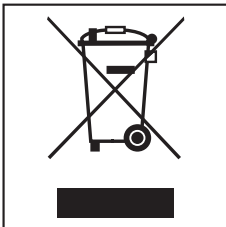

Please dispose of it at your local community waste collection / recycling centre and ensure that it presents no danger to children while being stored for disposal.

It should be unplugged or disconnected from the mains electricity supply by a competent person. The plug must be rendered useless and the cable cut off directly behind it to prevent misuse. See the "Warning and Safety" section of this booklet for further details.

Energy saving tips

To avoid unnecessarily long drying times and high consumption of energy:

- Make sure that your laundry is thoroughly spun before drying.

The higher the spin, the greater the savings that can be made in energy and time during drying.

- Load according to the optimum amount of laundry recommended for the programme being used (see Programme chart).

Underloading is uneconomical. Overloading gives a poorer quality of drying and may cause unnecessary creasing.

- Make sure the room in which the dryer is located is well ventilated.
- Make sure the fluff filters are clean before using the dryer.
- Check the condenser unit from time to time and clean it when necessary.

Caring for the environment	2
Disposal of the packing material	2
Disposal of your old appliance	2
Energy saving tips	2
Warning and Safety instructions	6
Operating the tumble dryer	10
Control panel	10
Display	11
Before using for the first time	12
Notes on laundry care	13
Care symbols	13
Tips on drying	13
How to dry correctly	14
Brief instructions	14
Extra options	17
Low temperature	17
Short	17
Anti-crease	17
Buzzer	17
Delay start	18
Programme chart	19
Changing the programme sequence	23
Changing a programme while it is running	23
To cancel a programme	23
To interrupt a programme	23
Adding or removing laundry after a programme has started	23
Electronic programme locking	24

Contents

Cleaning and care	25
Emptying the condensed water container	25
Cleaning the fluff filters	26
Cleaning them whilst dry	26
Cleaning them with water	27
Cleaning the tumble dryer	27
Cleaning the condenser unit	28
Removing the condenser unit	28
Checking the condenser unit	29
Cleaning the condenser unit	29
Replacing the condenser unit	30
Problem solving guide	31
Problem solving guide	31
Fault messages in the display	31
Other problems	33
Changing the lamp	36
After Sales service	37
Future updates (PC)	37
Appliance guarantee	37
Optional accessories	37
Installation	38
Front view	38
Installation site	39
Transporting the machine to its installation site	39
Building under a continuous worktop / in a row of kitchen units	39
Replacing the lid	39
Levelling the machine	40
Room in which the dryer is located	40
Washer - dryer stack	40
Before moving the machine again (e.g. when moving house)	40
External condensed water outlet	41
Setting up the drain hose	41
Connection to a sink drain outlet	42
If you no longer wish to use an external condensed water outlet	42

Electrical connection	43
Electrical connection U.K.	43
Consumption data	44
Technical data	45
Settings menu ▮	48
Language ▮	48
Time of day	49
Drying levels	49
Extending the cooling down time	49
Airways indicator	50
Lock	50
Buzzer	52
Display contrast	52
Display brightness	52
Keypad tones	52
Standby	52

Warning and Safety instructions

To avoid the risk of accidents and damage to the machine please read these instructions carefully before using it for the first time. They contain important information on its safety, installation, use and maintenance.

Keep these instructions in a safe place and ensure that new users are familiar with the content. Pass them on to any future owner of the machine.

Correct use

■ The tumble dryer is only intended for drying fabrics which have been washed in a water solution, marked on the manufacturer's care label as being suitable for tumble drying.

"Dry cleaning kits" for freshening up garments in a tumble dryer are increasingly available on the market. If using, do so at your own risk, and follow the instructions provided on the packaging.

Any other applications may be dangerous. The manufacturer is not liable for damage resulting from improper use or operation.

Technical safety

■ Before setting up the machine, check it for any externally visible damage.

Do not install or use a damaged machine.

■ Before connecting the machine, ensure that the connection data on the data plate (voltage and connected load) match the mains electricity supply. If in any doubt, consult a qualified electrician.

■ The electrical safety of this machine can only be guaranteed when continuity is complete between it and an effective earthing system which complies with local and national regulations. It is most important that this basic safety requirement is present and regularly tested, and where there is any doubt the household wiring system should be inspected by a qualified electrician. The manufacturer cannot be held liable for the consequences of an inadequate earthing system (e.g. electric shock).

■ Do not connect the appliance to the mains electricity supply by an extension lead. Extension leads do not guarantee the required safety of the appliance (e.g. danger of overheating).

Warning and Safety instructions

■ The machine is built in accordance with current safety requirements.

Unauthorised repairs could result in unforeseen dangers for the user, for which the manufacturer cannot accept liability. Repairs should only be undertaken by a Miele approved technician.

Ensure current is not supplied to the machine until after maintenance or repair work has been carried out.

■ Faulty components must only be replaced by genuine Miele original spare parts. Only when these parts are fitted can the safety standards of the machine be guaranteed.

■ If the connection cable is faulty it must only be replaced by a Miele approved service technician to protect the user from danger.

■ In countries where there are areas which may be subject to infestation by cockroaches or other vermin, pay particular attention to keeping the machine and its surroundings in a clean condition at all times. Any damage which may be caused by cockroaches or other vermin will not be covered by the machine guarantee.

Warning and Safety instructions

■ In the event of a fault or for cleaning purposes, the machine is only completely isolated from the electricity supply when:

- it is switched off at the wall socket and the plug is withdrawn, or
- it is switched off at the mains, or
- the mains fuse is withdrawn.

Operation

■ This equipment may only be used in mobile installations such as ships, caravans, aircraft etc. if a risk assessment of the installation has been carried out by a suitably qualified engineer.

■ The dryer must not be used without the fluff filters in place or if the fluff filters are damaged in any way.

■ The fluff filters must be thoroughly dried after cleaning. If they are still damp or wet when replaced there is a risk of faults occurring when the machine is used.

■ The dryer must not be used without the condenser unit in place.

■ Do not install the machine in a room where there is a risk of frost occurring. At temperatures around freezing point the machine may not be able to operate properly. There is a risk of damage if the condensed water is allowed to freeze in the pump, hoses and / or condensed water container. The ambient room temperature should be between +2°C and +35°C.

■ If the water is drained externally through the drain hose instead of being collected in the condensed water container, make sure the drain hose is securely attached if you hang it in a sink or basin to avoid the hose slipping and the water causing damage.

■ Condensed water is not drinking water. It can cause health problems in both people and animals.

■ Always keep the area around the machine free of dust and fluff. Dust drawn into the machine can, over time, cause blockages in the condenser unit.

Warning and Safety instructions

■ To prevent the risk of fire the following textiles must not be dried in this machine:

- fabrics which contain a large proportion of rubber, foam rubber or rubber like materials.
- items which contain padding or fillings (e.g. pillows, jackets).
- items which have been treated with inflammable cleaning agents.
- items which have been splashed with hair lacquer, hair spray, nail varnish remover or similar substances.
- items which have been soiled with oils or residues containing grease (kitchen oils, cosmetics etc.).
- items soiled with wax or other chemicals (e.g. mops and floor cloths).
- items which have not been thoroughly cleaned and which are still soiled with grease or oil, e.g. workwear. Such clothing may require a heavy duty detergent to get them clean. If necessary consult the detergent manufacturer for advice.

■ Do not let anyone sit or lean on the door, as this can cause the machine to tip up.

■ Always close the door after use. This way you will avoid the danger of:

- **children** climbing onto or into the dryer or hiding things in it.
- **pets** or other small animals climbing into it.

Safety with children

■ This machine is not a toy. To avoid the risk of injury keep children away from the machine at all times and supervise them whilst you are using it. Do not allow children to play on or near it or to play with its controls. Supervise its use by the elderly or infirm.

Using accessories

■ Accessory parts may only be fitted when expressly approved by Miele.

If non-Miele parts are used with this machine, guarantee, performance and product liability claims may be invalidated.

Disposal of your old machine

■ Before discarding an old machine, switch it off at the wall socket and unplug it. Render the plug useless and cut off the cable directly behind the machine. This should be done by a competent person.

■ The manufacturer cannot be held liable for damage caused by non-compliance with these Warning and Safety instructions.

Operating the tumble dryer

Control panel

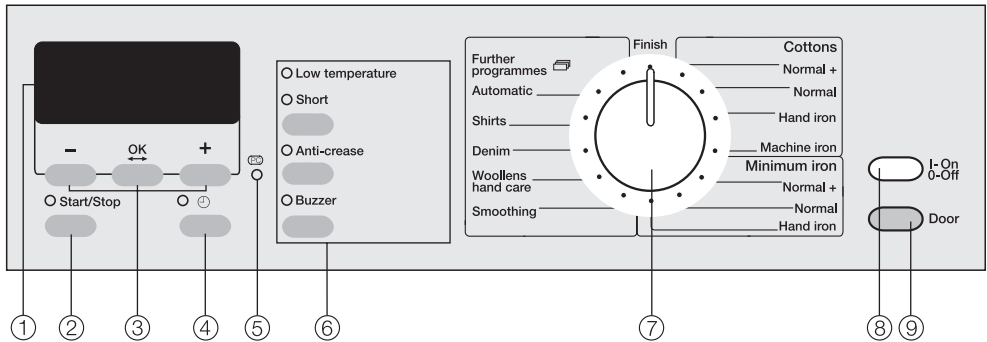

① **Display**

See the following pages for more information.

② **Start/Stop button**

For starting the programme selected and cancelling a programme once it has started.

③ **-, OK and + buttons**

See the following page for more information.

④ **⌚ button**

For selecting delay start and displaying the time of day.

⑤ **PC / Optical interface**

This is used by service technicians to run diagnostic checks on your machine and can also be used to update programming data in the future.

⑥ **Extras buttons** with indicator lights

Various Extras (options) can be added to the drying programmes.

⑦ **Programme selector**

For selecting a programme. The programme selector can be turned clockwise or anti-clockwise.

⑧ **I-On/0-Off button**

For switching the dryer on and off.

⑨ **Door button**

Pressing this button will open the door, even if the machine is switched off at the mains.

Display

The following are shown in the display:

- Programme Selection menu
- Programme duration and the programme start and end time
- Fault and error messages

When a programme is selected, the display is used to select:

- Different drying levels
- Delay start

The *Settings*  menu is also operated via the display.

- / + buttons

For altering the values shown in the display:

- decreases the value or moves the highlighting upwards
- + increases the value or moves the highlighting downwards

OK button

For confirming the value selected and choosing the next option.

button

For selecting delay start.

You can also press this button during a drying programme to check the estimated programme end time or the current time of day.

Estimated time remaining

When a programme is selected the estimated drying time will appear in the display. Please be aware that it is only an estimate!

The following factors all affect the estimated time remaining: Residual moisture content after spinning; type of fabric; size of load; room temperature; fluctuations in power supply.

The electronics continually assess conditions in the machine and adjust the estimated time remaining for a more accurate reading. Because of this the time displayed can alter during the course of a programme.

In the same way, the *Woollens hand care* and *Smoothing* programmes can finish earlier than expected if a certain temperature is reached. This can happen with particularly fine fabrics or if items were partly dry beforehand.

Operating the tumble dryer

Before using for the first time

When the tumble dryer is switched on for the first time, the welcome screen will appear.

The welcome screen will not appear again after you have entered the time of day, and run an initial programme lasting longer than one hour.

The display for setting the time of day will appear.

To set the time of day



- Set the hour with the - and + buttons and confirm your setting by pressing the *OK* button.
- Now set the minutes and confirm your selection.

Entry menu

The entry menu showing the current time of day will appear after the machine has been switched on, until you select an option.

After a few seconds an additional line will appear in the display. *Settings* :

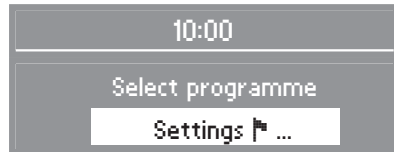



See "Settings menu" at the end of this booklet for more information.

You can now load the laundry into the dryer and select a programme as described in "How to dry correctly".

Care symbols

Before drying check the drying symbol on the care label. If there are no symbols, dry at your own risk!

-  Dry at normal temperature
-  Dry at a low temperature
-  Do not tumble dry

Tips on drying

- Always observe the maximum recommended loads given in the "Programme chart". Never overload the drum.

Overloading can cause unnecessary wear and tear to the laundry, give a disappointing drying result and cause more creasing.

- Do not put soaking wet items into the tumble dryer. Spin them thoroughly after washing using the appropriate spin speed.
- For delicates and fabrics with the following care label  select *Low temperature*.
- Use the *Automatic* programme for drying mixed loads of cottons and minimum iron fabrics.
- Open jackets so that they can dry evenly.
- Woollens and wool blends tend to become matted and shrink if dried in a tumble dryer. They can, however, be partially dried using the *Woollens hand care* programme.

- Down-filled garments have linings which have a tendency to shrink, depending on the quality of the item. They can be partially dried using the *Smoothing* programme.
- Pure linen should only be machine dried if specified as suitable by the manufacturer on the care label, as the surface of the fabric may otherwise become rough. They can be partially dried using the *Smoothing* programme.
- Loopknit garments (e.g. T-shirts and underwear) tend to shrink depending on their quality. Do not over-dry these textiles. When purchasing these garments it is advisable to take their shrinkage properties into account.
- For garments made from very fine weave fabrics, such as shirts or blouses, only use the *Shirts* or *Delicates* programme to avoid creasing. If in doubt, reduce the load or use the *Smoothing* or *Silks handcare* programme.
- Starched laundry can be dried in the tumble dryer. To achieve the usual finish, double the amount of starch should be used.
- New dark coloured garments should be washed and dried separately from light coloured garments to avoid the danger of colours running and discolouring other garments or even plastic components in the machine. Dark coloured fibres can also settle on light coloured garments and vice versa.

How to dry correctly

Brief instructions

The headings numbered (1, 2, 3 ...) show the operating sequence and can be used as a brief guide to using your machine.

1 Sort the laundry

To ensure an even drying result separate out the washed laundry and sort it according to: . .

- . . . the drying level required
- . . . the type of fibre or weave
- . . size
- . . the moisture content after spinning.

 Make sure that objects e.g. detergent dispensing balls have been removed from the laundry. They could melt, and cause damage to the dryer or the laundry.

- Check seams and stitching to ensure that padding and linings are intact.
- Fasten duvet covers and pillow cases to prevent small items from being trapped inside them.
- Fasten hooks and eyes etc.
- Tie fabric belts and apron strings.
- Sew in or remove underwiring from bras.

2 Turn on the tumble dryer

- Switch the dryer on by pressing the *I-On/0-Off* button in.

The tumble dryer may be switched on after loading, saving energy as the light will not come on.

3 Load the tumble dryer

- Press the *Door* button to open the door.
- Load the laundry loosely into the drum.

Do not overload the drum. See the "Programme chart" for recommended loads for each programme. Overloading can cause unnecessary wear and tear to the laundry and give a disappointing drying result.

- Before closing the door make sure the fluff filter is correctly positioned.

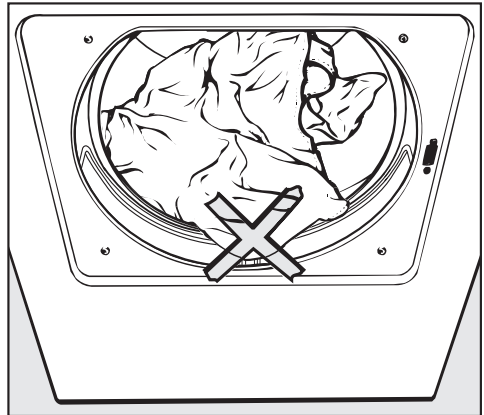

Check the laundry is right inside the drum so that it cannot get trapped or damaged when the door is shut.

- Shut the door either with a gentle swing, or lean against it and push it shut.

4 Select a programme

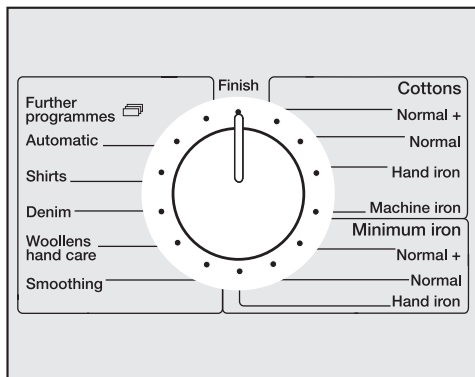

- Turn the selector to the programme you require.

The display will vary according to which programme has been selected. First only the programme name will appear:



The display will then change. Please note that the programme duration shown in the display, will vary according to the programme selected (see "Estimated time remaining").

Cottons, Minimum iron, Automatic, Shirts, Denim

You can select various drying levels for these programmes.



- Use the + or - button to alter the drying level on Automatic, Shirts and Denim.

Woollens Hand care, Smoothing

You cannot select a drying level or a duration for this programme.

Further programmes

When you select this setting the further programmes will appear in the display.

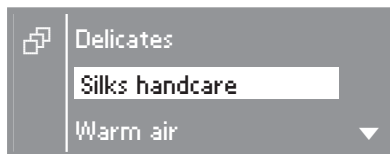

- Use the + or - button to highlight the programme you want. The arrow ▼ in the display indicates that there are further options.
- Confirm your selection by pressing the OK button.



- You can use the + or - button to alter the drying level for the *Outerwear, Delicates and Sportswear* programmes.



- You can use the + or - to increase or decrease the duration from 15 min. up to 2 h for the *Warm air* or *Cool air* timed drying programmes.

You cannot alter the drying level or duration for the other programmes.

How to dry correctly

Selecting Extra options

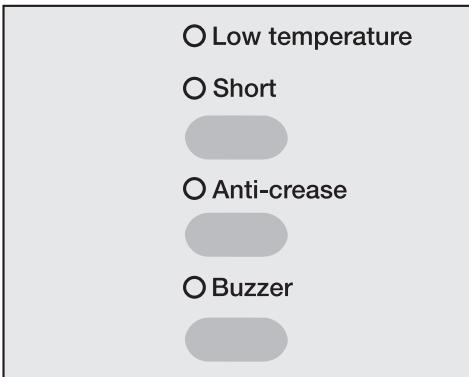

- Select the Extra option you want.
Indicator light on = Extra option is selected

To select delay start

- See "Delay start".

5 Start the programme

The indicator light for the *Start/Stop* button will flash when a programme is being selected. The flashing indicates that a programme can be started.

- Press the *Start/Stop* button.

The indicator light for the *Start/Stop* will then change from flashing to being on constantly.

Programme start will appear in the display, followed by *Drying* and the programme duration.

With sensor drying programmes, e.g. *Machine iron*, *Hand iron*, etc. the drying level reached will be shown in the display later on.

Before the end of a programme

There is a cooling down phase at the end of the drying sequence: *Cool down* will appear in the display. The programme will not finish until the cooling down phase has been completed.

There is no cooling down phase at the end of the following programmes: *Woolens hand care*, *Smoothing*.

At the end of a programme

Anti-crease (if selected) and *Finish* will appear in the display to indicate that the programme has finished. The buzzer will sound (if selected).

6 Remove the laundry

- Press the *Door* button to open the drum door.
- Remove the laundry.

Make sure that the drum is empty. If items are left in the dryer, they could be damaged by overdrying when the dryer is next used.

If the appliance is switched on and the door is opened, the drum lighting will come on. It will go out a few minutes later to save energy.

- Switch the dryer off by pressing the *I-On/O-Off*-button.
- Clean the fluff filters.
- Close the door.
- Empty the condensed water container (unless the dryer is connected for external drainage).

Low temperature

Short

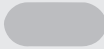

Anti-crease

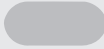

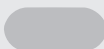

Buzzer



- Each press of the top button selects the Extra option - indicator light on (and deselects the previous option) or no option is selected.
- It is not possible to select the *Short* and *Low temperature* options at the same time.
- Not all the extra options are suitable for use with every programme.

Low temperature

For drying delicates and fabrics with the  symbol on the care label at a lower temperature.

- For all delicate or minimum iron fabrics with the  symbol on the care label (e.g. acrylic garments).
- The programme duration is longer.
- On some programmes *Low temperature* is a standard part of the programme and so cannot be deselected.

Short

For drying fabrics which can withstand higher temperatures and have  on the care label. Do not use on minimum iron or delicate fabrics.

- The programme duration is shorter.

Anti-crease

Helps prevent creasing, if laundry is not normally removed immediately after the end of a programme.

- The drum will turn at intervals for up to an hour.

Buzzer

A buzzer sounds (at intervals for a maximum of 1 hr) to let you know the programme has finished.

- You can change the volume of the buzzer. See "Settings 
- The buzzer will always sound when there is a fault, even if it has been switched off.

Delay start

With delay start you can choose when you want the programme to end, allowing you to make use of night-time economy electricity rates for example. The start of a programme can be delayed by up to 24 hours.

To select delay start

- Select the programme you want and then press the ⊖ button.

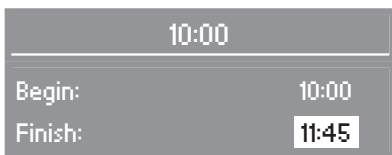

The display will show the current time of day at the top, the time the programme will start in the middle and the time the programme will finish at the bottom.

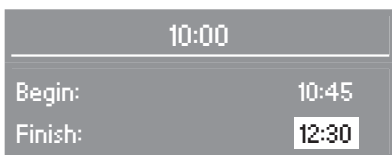

- Use the + button to select the time you want the programme to end at.

The delay start time is selected in 30-minute steps. The first press on the button will adjust the programme end time to the next full or half hour. The start time of the programme is also adjusted accordingly.

Use the - button to shorten the end time if you have chosen too long a time.

- Confirm your selection by pressing the OK button.

To begin delay start

- Press the *Start/Stop* button.



The delay start time will now count down in minutes until the start of the programme.

The drum will turn briefly every hour to help prevent creasing.

Changing the programme sequence

While the delay start time is counting down, you can still . . .

. . . change the *Extra* options or drying levels.

. . . press the *Door* button and add or remove laundry. After closing the door, press the *Start/Stop* button again.

To alter delay start

- Press the ⊖ button.
- Use the - or + button to alter the time you want the programme to end at.
- Confirm your selection by pressing the OK button.

To delete delay start

- Press the ⊖ button.
- Press and hold the - pressed in, until the time the programme is due to start at is the same as the current time of day.
- Confirm your selection by pressing the OK button.

The programme will now start immediately.

Programme chart

Cottons		Max. load: 6 kg*
Normal+, Normal**		
Fabric type	Single and multi-layered cotton fabrics such as towelling, jerseywear, underwear, flannelette bed linen.	
Extra options	Low temperature (select this option for delicate fabrics with the ☐ symbol on the care label), Short, Anti-crease, Buzzer	
Hand iron Δ** , Machine iron		
Fabric type	Cottons or linen fabrics, e.g. table linen, bedlinen, starched laundry.	
Note	– To prevent laundry from drying out it should be rolled up until you are ready for ironing.	
Extra options	Low temperature (select this option for delicate fabrics with the ☐ symbol on the care label), Short, Anti-crease, Buzzer	
Minimum iron		Max. load: 3 kg*
Normal+, Normal**, Hand iron Δ		
Fabric type	Minimum iron items made of cotton, synthetic or blended fabrics, e.g. shirts, blouses, skirts and table cloths.	
Note	– In the Minimum iron <i>Hand iron</i> programme, items are dried with very little creasing, depending on fabric type and amount of laundry.	
Extra options	Low temperature (select this option for delicate fabrics with the ☐ symbol on the care label), Short, Anti-crease, Buzzer	
Automatic		Max. load: 3 kg*
Normal+, Normal, Hand iron Δ		
Fabric type	Mixed load of cotton and minimum iron fabrics.	
Extra options	Anti-crease, Buzzer	

* Weight of dry laundry

** Note for test institutes:

Use this programme without any Extra options when testing according to EN 61121 Standard.

Programme chart

Shirts		Max. load: 2 kg*
Normal+, Normal, Hand iron Δ		
Fabric type	Shirts and blouses	
Extra options	Anti-crease, Buzzer, Low temperature. (Low temperature cannot be deselected).	
Denim		Max. load: 3 kg*
Normal, Hand iron Δ		
Fabric type	Denim fabrics, e.g. jeans, jackets, skirts, shirts.	
Extra options	Anti-crease, Buzzer, Low temperature. (Low temperature cannot be deselected).	
Woollens hand care		Max. load: 2 kg*
Fabric type	Woollen fabrics	
Notes	<ul style="list-style-type: none"> – To refresh and fluff up woollen garments quickly. Woollen fabrics are not dried completely by this programme. – Remove garments as soon as the programme has finished and leave to finish drying at room temperature. 	
Extra options	Buzzer, Low temperature. (Low temperature cannot be deselected).	
Smoothing		Max. load: 3 kg*
Fabric type	<ul style="list-style-type: none"> – Cottons and linen fabrics. – Minimum iron items made of mixed fibres, cottons or synthetics, e.g. trousers, jackets, shirts. 	
Notes	<ul style="list-style-type: none"> – Smooths out creasing caused during the spin cycle in the washing machine. – Fabrics are not completely dried in this programme. Remove garments as soon as the programme has finished and leave to finish drying at room temperature. 	
Extra options	Anti-crease, Buzzer, Low temperature. (Low temperature cannot be deselected).	

* Weight of dry laundry

Programme chart

Silks handcare		Max. load: 1 kg*
Fabric type	Silks, e.g. blouses and shirts.	
Notes	<ul style="list-style-type: none"> – Smooths out creasing. – Fabrics are not completely dried in this programme. Remove garments as soon as the programme has finished and leave to finish drying at room temperature. 	
Extra options	Anti-crease, Buzzer, Low temperature. (Low temperature cannot be deselected).	
Timed Drying		Max. load: 6 kg*
Warm air		
Fabric type	<ul style="list-style-type: none"> – Multi-layered fabrics whose layers have different drying characteristics, e.g. jackets, pillows. – For drying individual items, e.g. bath towels, bathing costumes, tea-towels. 	
Notes	– Do not select the longest drying time to start with. Check the items as you are drying them to find the optimum time.	
Extra options	Buzzer, Anti-crease, Low temperature	
Cool air		
Fabric type	Any item which only needs airing.	
Extra options	Anti-crease, Buzzer	
Outerwear		Max. load: 2 kg*
Normal, Hand iron Δ		
Fabric type	Outerwear which is suitable for drying in a tumble dryer.	
Extra options	Anti-crease, Buzzer	
Delicates		Max. load: 2 kg*
Normal+, Normal Hand iron Δ, Hand iron $\Delta\Delta$, Machine iron		
Fabric type	For delicate garments made of synthetic fibres, mixed fibres, easy care cotton shirts and blouses and evening wear with sequins and beading.	
Extra options	Anti-crease, Buzzer, Low temperature. (Low temperature cannot be deselected).	

* Weight of dry laundry

Programme chart

Sportswear		Max. load: 2 kg*
Normal+, Normal, Hand iron Δ		
Fabric type	Sportswear which is suitable for drying in a tumble dryer.	
Extra options	Anti-crease, Buzzer	
Pillows large		1 pillow up to 80x80 cm
Pillows		1-2 pillows up to 40x40 cm
Fabric type	Pillows suitable for drying in a tumble dryer, with feather, down or synthetic fillings.	
Note	– Please observe the instructions on the care label. Pillows can still feel damp after being dried. You can use this programme several times until the pillow feels dry.	
Extra options	Anti-crease, Buzzer	
Proofing		Max. load: 2 kg*
Fabric type	For drying microfibre fabrics, skiwear, fine, closeweave cotton garments (poplin) or tablecloths which are suitable for drying in a tumble dryer and have been treated to provide a water and dirt resistant finish.	
Notes	<ul style="list-style-type: none"> – This programme includes a proofing fixing phase. – Only use proofing agents which are stated by the manufacturer as being "suitable for use on membrane textiles" as these contain fluorochemical compounds. – Do not dry items which have been treated with proofing agents containing parafin. Fire hazard! 	
Extra options	Anti-crease, Buzzer	

* Weight of dry laundry

Changing the programme sequence

Changing a programme while it is running

You cannot change to another programme once a programme has started (this prevents unintentional alterations). If the programme selector is altered, the words *Programme cannot be changed* appear if the selector is not turned back to the original programme.

You will need to cancel the current programme before you can select a new one.

To cancel a programme

- Press the *Start/Stop* button.

The items will be cooled down, depending on how long they have been dried for and the temperature reached.

If you press the *Start/Stop* button again during the cooling down phase, *Finish* will appear in the display.

To select a new programme:

- Switch the dryer off with the *I-On/O-Off* button.
- Switch the dryer back on with the *I-On/O-Off* button.
- Select a different programme.

To interrupt a programme

- Switch the dryer off with the *I-On/O-Off* button.

To continue drying

- Switch the dryer back on with the *I-On/O-Off* button.

The programme will continue, as long as the cooling down phase has not been reached.

Adding or removing laundry after a programme has started

- Press the *Door* button.
- Open the door.

 Do not touch the back of the drum when adding or removing items. The drum could be very hot - danger of burning.

- Add or remove items.
- Close the door.

To continue drying

- Press the *Start/Stop* button.

The time left shown in the display may now vary from the actual drying time.

Electronic programme locking

Programme locking prevents the programme sequence being altered when drying is in progress.

The door is not locked and can be opened at any time.

To activate programme locking

- Once the programme has started, press and hold the *Start/Stop* button for at least 6 seconds until the following appears in the display:

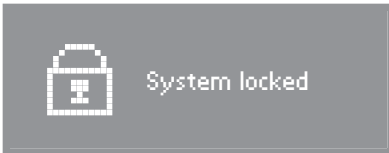

Now no more alterations can be made to the programme.

To deactivate programme locking

- Press and hold the *Start/Stop* button for at least 6 seconds until the following appears in the display:

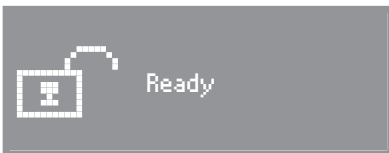

Important:

Programme locking is deactivated automatically at the end of the programme or by pressing the *Door* button.

Emptying the condensed water container

The condensed water will be collected in the condensed water container unless the appliance has been fitted with a drain hose (see installation).

Empty the condensed water container after every drying programme.

The drying programme will be interrupted if the maximum level of the condensed water container is reached. A message will appear in the display.

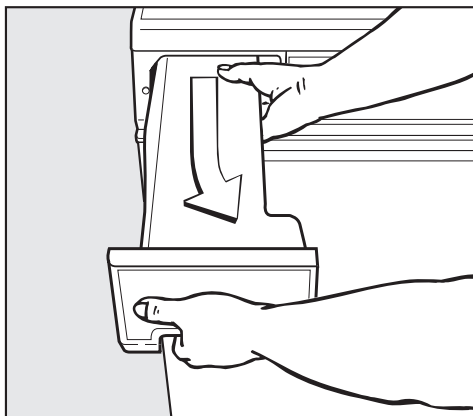

- Holding the container firmly in both hands, as shown, pull it out slightly towards the right-hand side.
- Hold the container in a horizontal position when carrying it.

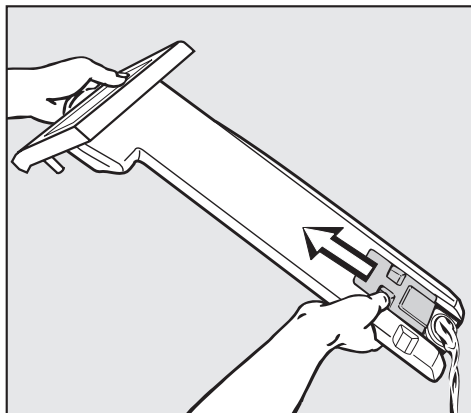

- Open the shutter and empty out the water.
- To replace the container, hold it at a slight angle (as when removing it) and push it in gently until you feel it click into position.
- To remove the message from the display, switch the dryer off and then on again.

Condensed water should not be consumed. It could lead to health problems for people and animals.

Condensed water can be put to household use (e.g. used in a steam iron or humidifier). To ensure that any residual particles of fluff in the condensed water are removed before use, pass it through a fine sieve or paper filter first.

Cleaning and care

Cleaning the fluff filters

The fluff which is created by the drying process is collected by the fluff filters in the door and the door opening. Clean the filters after **each** drying programme.

Cleaning them whilst dry

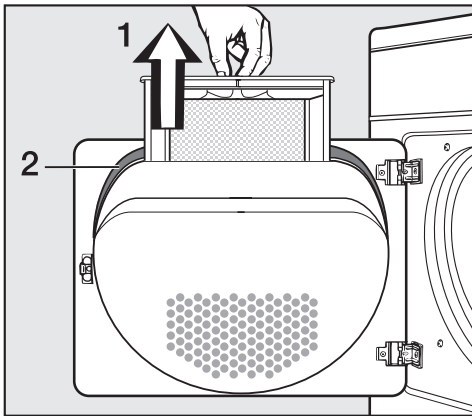

- Open the door and pull the fluff filter (1) out of the door as illustrated.

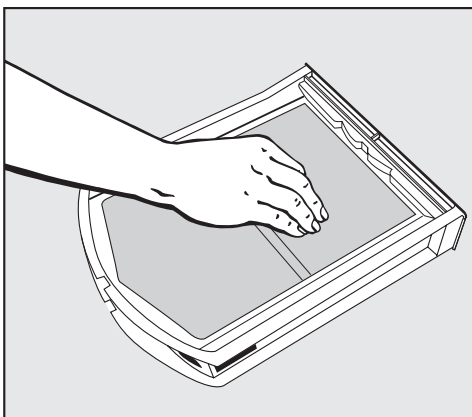

- Use your fingers to remove the fluff from the surface of the filter.

- Remove any fluff from the hollow part of the door holder. A cleaning brush is available as an optional extra from your Miele dealer or the Miele Spare Parts Department.

Tip: You can also use a vacuum cleaner.

- Once clean, push the filter back into the door holder until it clicks into position. Ensure it is facing the correct way.
- Also clean the door seal (2) with a damp cloth.

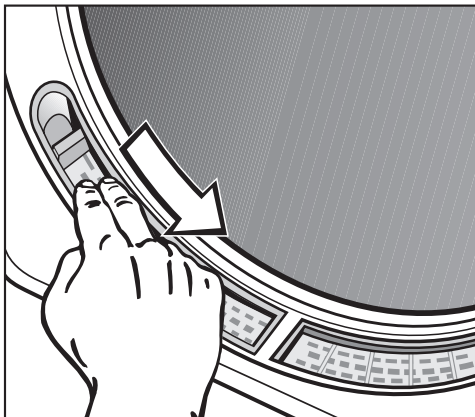

- Use your fingers to remove the fluff from the two fluff filters in the door opening.
- Close the door.

Cleaning them with water

If there is a great deal of compacted fluff on any of the filters, they can be removed and cleaned under hot running water.

- To remove the fluff filter from the door holder see previous page.

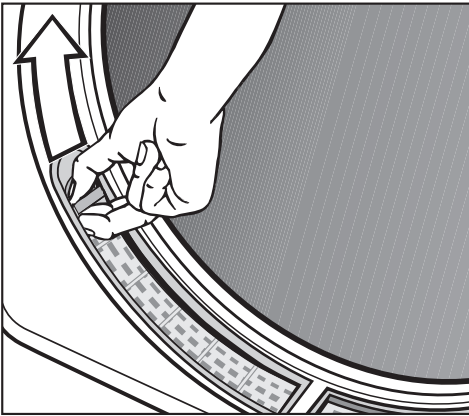

- To remove the filters in the door opening, grip the holder and push upwards in the direction of the arrow to remove it.
- Rinse the filters under hot, running water.
- Then shake the filters until no more water droplets are visible.
- Dry the filters thoroughly with care.

 Do not replace them if they are damp or wet. Damp or wet filters could cause operational faults.

- Push the large filter back into the door holder until it clicks into position. Ensure it is facing the correct way.

- Place the filters back in the door opening (the left and right filters are identical) with the finger holders facing upwards. See illustration.

Cleaning the tumble dryer

Disconnect the machine from the mains electricity supply.

- Clean the housing and control panel with a slightly damp cloth and a mild detergent or soapy water.
- The drum and other stainless steel parts can be cleaned with a suitable proprietary stainless steel cleaner following the manufacturer's instructions.

Do not use solvents, abrasive cleaners, glass cleaners or all-purpose cleaners. These could damage plastic surfaces and other parts. The machine must never be hosed down.

- Dry all parts with a soft cloth.
- A microfibre E-Cloth is available from the Miele UK Spare Parts Department which is suitable for cleaning surfaces such as stainless steel, glass, plastic and chrome without the use of chemicals. It can be washed 300 times.

Cleaning and care

Cleaning the condenser unit

Detergent residue, hair and fine fluff from the dryer can get through the fluff filters and block the condenser unit.

Dust from the room in which the dryer is installed can also get into the condenser unit and cause a blockage.

Check the condenser unit at least twice a year. If the dryer is used frequently then clean the condenser unit after approx. 100 drying cycles.

Removing the condenser unit

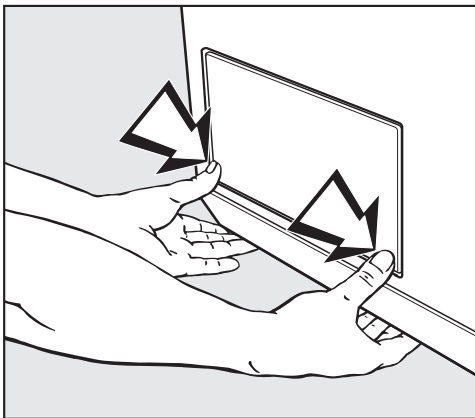

- Open the service panel by pressing the two lower corners at the same time (see illustration). The hooks at the side will prevent the panel from falling off.
- Now remove the panel by pulling it diagonally upwards.
- Then place it to one side.

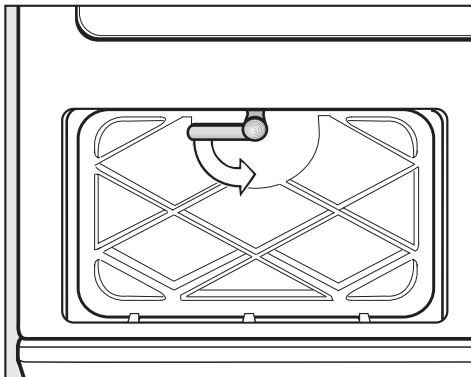

- Turn the lever on the inner cover downwards to the vertical position.
- Pull the cover forwards
- Then remove it by pulling it diagonally upwards.

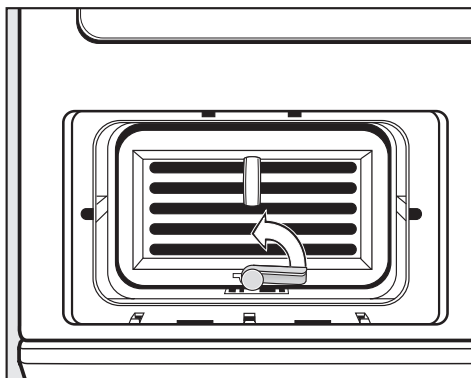

- Turn the lever on the condenser unit to the vertical position.

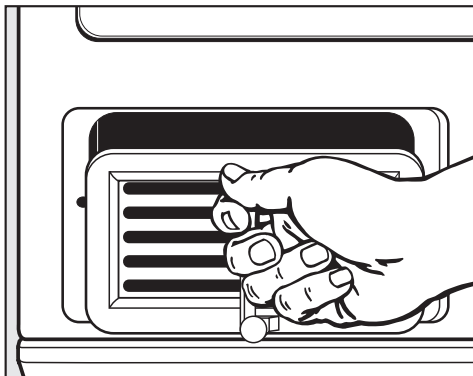

- Pull the condenser unit out of its housing by the handle.

Checking the condenser unit

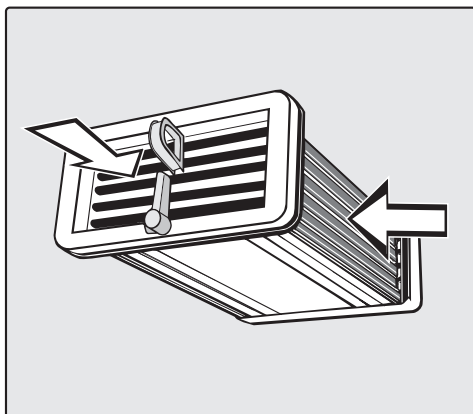

- Hold the condenser unit up to the light **as shown**.
- Check to see if there is any fluff inside it.
The arrows in the illustration above indicate where to look.

If you cannot see any fluff:

- Replace the condenser unit (see following page).

If you can see some fluff:

- Clean the condenser unit as described below.

Cleaning the condenser unit

- **When rinsing the condenser unit, make sure you position it as shown in the next two illustrations.**

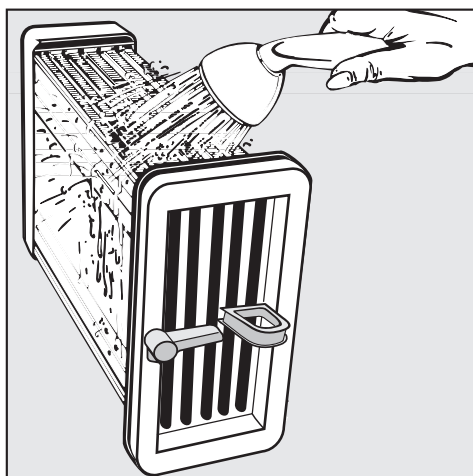

- Use a shower head or similar to rinse the unit out **as shown**.

Cleaning and care



- Then flush the unit through from the front.
- Check the condenser unit again for any visible fluff and if necessary flush it through again until it has all gone.
- Remove any soiling still visible inside the housing unit by hand using a damp cloth. Do not try and access areas you cannot reach by hand!
- Also make sure the rubber seals are clean.

The rubber seals must not be removed and must be free of kinks.

Replacing the condenser unit

- With the handle facing upwards, push the condenser unit back into position in its housing.
- Turn the lever down to the horizontal position, making sure that the hook on the lever clicks into the groove.

When replacing the cover after cleaning, ensure that the rubber seal fits correctly into the groove.

- Replace the cover making sure the hooks locate correctly. Hold it at an angle and push it gently downwards.
- Then turn the lever upwards into the horizontal position to lock the cover.
- Replace the service panel and press the upper edge until it clicks into position.





 It is important to ensure that both the condenser unit and the cover are correctly positioned and locked otherwise water may leak from the machine.

Problem solving guide



With the help of the following notes, minor faults in the performance of the appliance, some of which may result from incorrect operation, can be put right without contacting the Service Department.

 Repair work to electrical appliances should only be carried out by a suitably qualified person in accordance with local and national safety regulations. Repairs and other work by unqualified persons could be dangerous. The manufacturer cannot be held liable for unauthorised work.

Fault messages in the display

Problem	Possible cause	Remedy
Locked. Enter code	The lock has been activated.	See Settings menu  .
 System locked	The electronic programme lock has been activated.	Press and hold the <i>Start/Stop</i> button until <i>Ready</i> appears in the display.
 Adjust the load	This is not a fault. The electronic unit has recognised that there is no laundry in the drum and cancelled the programme. Drying individual garments or items which are already dry can also cause the programme to be cancelled.	Use the Warm air programme (timed drying) to dry individual items. To delete the fault message: – Open the door or switch the dryer off and then back on again.
 Empty the container	The condensed water container is full or there is a kink in the drain hose.	– Empty out the condensed water container or check the drain hose. To delete the fault message: – Switch the dryer off and then back on again.

Problem solving guide

Problem	Possible cause	Remedy
The following message appears after the programme has finished: Clean the filters	Air is not flowing freely through the dryer. – The dryer is not working efficiently or economically. – Possible causes: The fluff filters are clogged with fluff or with detergent residues.	– Clean the fluff filters. If they need to be cleaned with water, make sure they are completely dry before replacing them. – See also the notes on the next page under: "The drying process goes on too long or even switches off". To delete the fault message: – Switch the dryer off and then back on again.
	You can adjust the setting which controls when or if the message <i>Clean the filters</i> appears.	See Settings menu  , Airways indicator section.
 Technical fault Call the Service Department	No obvious cause. In some circumstances, <i>Clean the filters</i> will already have been displayed.	– Clean the fluff filters and the condenser unit. To delete the fault message: – Switch the dryer off and then back on again.
	There is a fault, if despite doing this, the programme is cancelled and the fault message appears again.	Contact the Miele Service Department.
i Programme cannot be changed	An attempt has been made to alter a programme while it is in progress.	You will need to cancel the current programme before you can select a new one.
i Programme finish time changed	This is not a fault.	Settings were changed during a delay start period, or there has been a power cut.



Other problems

Problem	Possible cause	Remedy
The drying process goes on too long or even switches off.	In some circumstances the following message also appears: <i>Clean the filters</i> Please check all the possible causes and switch the dryer off and then back on again.	
	Ventilation to and from the dryer may be insufficient (e.g because it is installed in a small room). This has caused the temperature in the room to rise sharply.	Open a door or window while the machine is in operation for increased air flow.
	The fluff filters are clogged up with fluff or were still wet when they were replaced.	<ul style="list-style-type: none"> – Remove any fluff. – The fluff filters must be completely dry.
	The laundry has not been spun sufficiently.	Make sure that your laundry is thoroughly spun at the washing machine's maximum spin speed.
	The tumble dryer has been overloaded.	Do not exceed the maximum load for the programme selected.
	Metallic components, e.g. zips have prevented the dryer from registering the correct moisture level in the laundry.	<ul style="list-style-type: none"> – Open zips next time. If the problem occurs again, dry garments with long zips using the Warm air programme (timed drying).
	Detergent residues, hair and fine fibres can block up the condenser unit.	Check the condenser unit from time to time and clean it if necessary.
	The vents below the door are blocked.	Remove any objects that are blocking the vents.
The laundry is not sufficiently dry.	The load consisted of different fabrics.	<ul style="list-style-type: none"> – Finish drying using the <i>Warm air</i> programme. – Select a different programme the next time.

Problem solving guide

Problem	Possible cause	Remedy
The condenser unit service panel will not shut.	The inner cover of the condenser unit has not been locked properly and/or the condenser unit has not been positioned correctly.	<ul style="list-style-type: none"> – Ensure that the condenser unit is positioned correctly and lock the cover. – Check the rubber seals.
Water leaks from the machine after the condenser unit has been cleaned.	Fluff has collected at the bottom of the condenser unit housing.	<ul style="list-style-type: none"> – Use a cloth to remove any fluff from the inside of the condenser unit housing.
Items made of synthetic fibres are charged with static electricity after drying.	Synthetic fibres tend to attract static charge.	Static charge can be reduced by adding a fabric conditioner to the final rinse in the washing machine or a fabric conditioner sheet to the load in the dryer.
There is a build up of fluff.	Fluff is principally the result of friction when garments are being worn and washed. Machine drying hardly causes any fluff to form and has been established by research institutes to have no appreciable effect on the lifetime of fabric.	Fluff is collected by the fluff filters and can be easily removed (see Cleaning and Care).
Feather filled pillows smell after drying.	Feathers are a natural product and this is quite normal.	The smell will dissipate after sufficient airing.

Problem solving guide

Problem	Possible cause	Remedy
The programme does not start and the display is dark.	No obvious cause.	<ul style="list-style-type: none"> – Is the dryer switched on? – Is the plug correctly inserted into the socket and switched on? – Is the door closed properly? – Has the fuse or circuit breaker tripped?
The interior drum lighting does not come on.	The lighting switches off automatically (to save energy).	Switch the dryer off and then on again.
	The lamp needs changing.	Change the lamp as described at the end of this section.
The display is in a different language.	A different language has been selected in "Settings  "Language  .	Set the language you want. The flag symbol will guide you.
The <i>Start/Stop</i> button light flashes when a programme is being selected.	This is not a fault. The flashing indicates that a programme can be started.	After the programme has started, the flashing will change to a constant light.
The display is dark and the light ring around the programme selector is not lit up. The <i>Start/Stop</i> button light flashes slowly.	The display has switched off automatically to save energy (Stand-by mode). The same applies to the programme selector.	The display or programme selector are lit up after pressing a button or turning the programme selector.
	The programme selector light goes out when the <i>Settings</i> menu has been selected.	The programme selector light lights up when a programme is selected.
	If the problem persists, there is a fault.	Contact the Miele Service Department.

Problem solving guide

Changing the lamp

Disconnect the machine from the mains electricity supply.

- Open the door.

You will find the interior lamp cover at the top of the drum aperture.

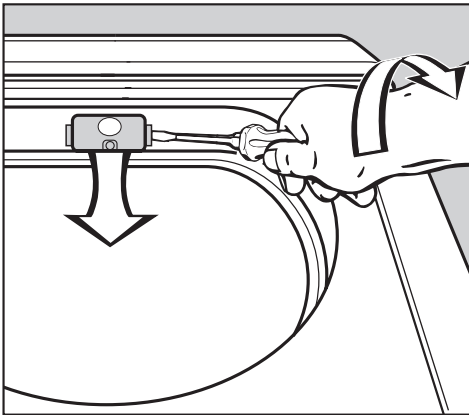

- Insert a suitable tool, such as a wide bladed screwdriver, under the side edge of the lamp cover as illustrated.
- Apply a little pressure and whilst doing so turn your wrist in the direction of the arrow to open the cover.

The cover will open downwards.

The temperature resistant lamp should only be ordered from your Miele dealer or the Miele Spare Parts Department.

The lamp specification and maximum wattage is stated on the data plate and on the lamp cover.

- Replace the lamp.
- To close the cover push it upwards and press it on the left and right until you hear it click into position.

⚠ Ensure that it is fitted into position securely, as any moisture could cause a short circuit.

In the event of any faults which you cannot remedy yourself, or if the machine is under guarantee, please contact

- your Miele dealer or
- the Miele Service Department (see back cover for contact details).

When contacting your dealer or the Service Department, please quote the model and serial number of your machine, both of which are shown on the data plate situated on the right hand side below the drum aperture.

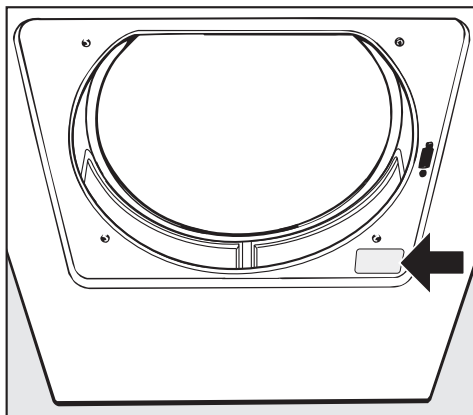

Future updates (PC)

The indicator or check light marked **PC** on the fascia panel is the interface used by the Miele service technicians during service work for testing purposes and for updating the machine's programme data.

Appliance guarantee

Please see the guarantee card supplied with your machine.

Optional accessories

Optional accessories for this dryer are available from your Miele Dealer or from the Miele Spare Parts Department.

Please note that telephone calls may be monitored and recorded to improve our service.

Installation

Front view

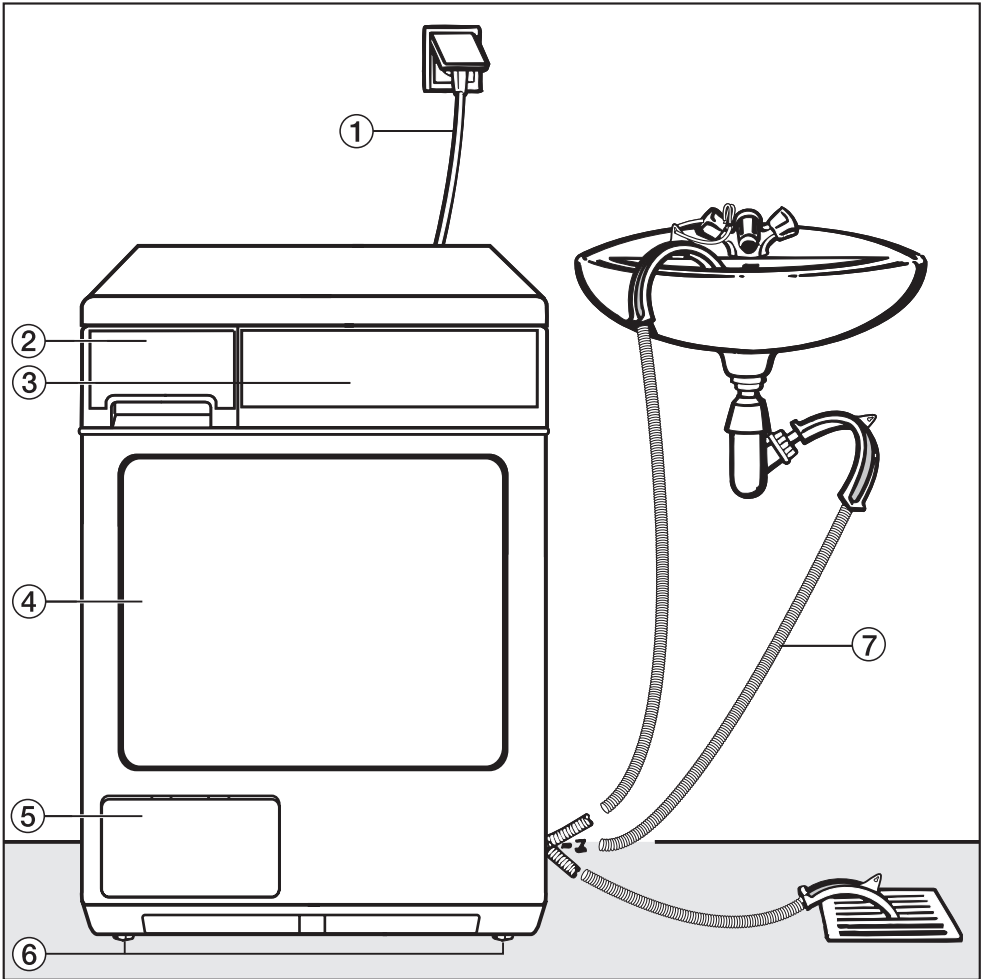

- ① Mains connection cable
- ② Condensed water container
- ③ Control panel
- ④ Door
- ⑤ Service panel for condenser unit
- ⑥ Four height-adjustable screw feet
- ⑦ External drainage options (e.g. via wash basin, wash basin drain outlet, or gully).

Installation site

 Make sure the dryer door can be opened without hindrance after installation.

Transporting the machine to its installation site

When moving the machine you can hold it by the lid where it protrudes to the rear of the dryer.

To manoeuvre the dryer out of its packing case to its installation site you will also need to hold it by the front feet.

Building under a continuous worktop / in a row of kitchen units

The dryer should not be installed next to a refrigerator or freezer. The warm air expelled from the rear of the dryer would increase the temperature around the refrigerator's/freezer's heat exchanger causing the compressor to run continuously.

If it is not possible to install the dryer anywhere else, then the refrigerator/freezer must be sealed off from the dryer.

If you wish to push your machine under a worktop and there is space to do this **without removing the lid**, a building under kit is not necessary. Otherwise the building under kit is essential.

 The **building under kit*** must be fitted by a suitably qualified person. The machine lid is replaced by a coverplate. It is essential that the coverplate is fitted to ensure electrical safety.

The building under kit is supplied with its own installation instructions.

N.B. When built under running times may be longer.

- The electrical socket must be located in an accessible position near the machine.

With niche heights of:

- 840 mm, longer screw feet* are required.
- 870/885 mm - 915/930 mm, one or two height adjustment frames* are required.

* Available as an optional accessory from your Miele dealer or the Miele Spare Parts Department.

Replacing the lid

If the lid has been removed in order to fit a cover plate, ensure that, if the lid is replaced, it fits securely into the rear holders. Otherwise, it is not properly secure for transport.

Installation

Levelling the machine

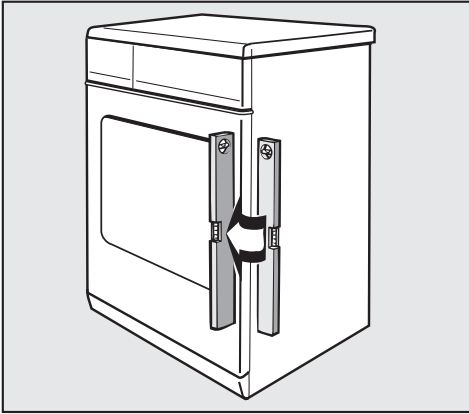

The machine must be perfectly level to ensure safe and proper operation.

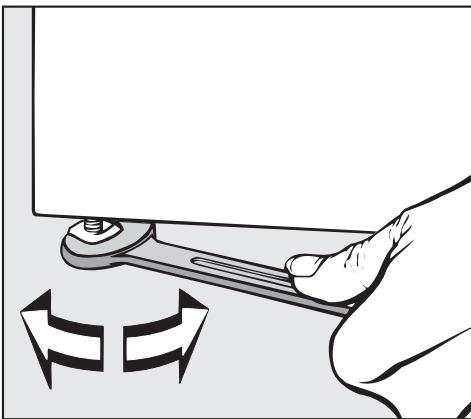

- The screw feet can be adjusted to compensate for any unevenness in the floor.

⚠ The ventilation gaps in the plinth must not be covered over as this would prevent a sufficient intake of air.

Room in which the dryer is located

Air taken in for use in the drying process will be warm when it is expelled from the rear of the dryer. This expelled air heats up the air in the room. It is therefore very important to ensure that the room is adequately ventilated, particularly if the dryer is located in a small room. Otherwise running times and energy consumption could be increased.

Washer - dryer stack

The tumble dryer can also be combined with a Miele washing machine in a washer-dryer stack. To do this the appropriate stacking kit* (WTV) to match your washing machine is required.

* Available as an optional accessory from your Miele dealer or the Miele Spare Parts Department.

⚠ Stacking kits must be fitted by a suitably qualified fitter.

Before moving the machine again (e.g. when moving house)

After each use a small quantity of condensed water will collect in the area around the pump. This water can run out if the machine is tipped up when it is being moved. It is a good idea to run the *Cool air* programme for approximately 1 minute before moving the machine. Any remaining condensed water will then be fed into the condensed water container or out through the drain hose.

External condensed water outlet

When drying is in progress, condensed water is pumped into the condensed water container through the drain hose at the back of the dryer. The condensed water can also be drained off directly if the machine is installed near a sink, drain outlet etc. so that the condensed water container does not have to be emptied.

The drain hose (approx. 2 m long) is stored in the dryer. It must be pulled out of the dryer to its full extent if condensed water is to be drained externally. Maximum delivery head: 1 m.

If it is not long enough, an extension hose is available as an optional accessory through your dealer or from the Miele Spare Parts Dept.

Setting up the drain hose

From the back of the dryer at the top:

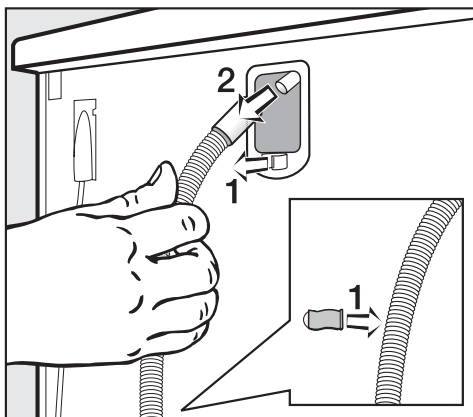

- Unclip the drain hose from clip (1).
- Then pull it off holder (2).

From the back of the dryer at the bottom:

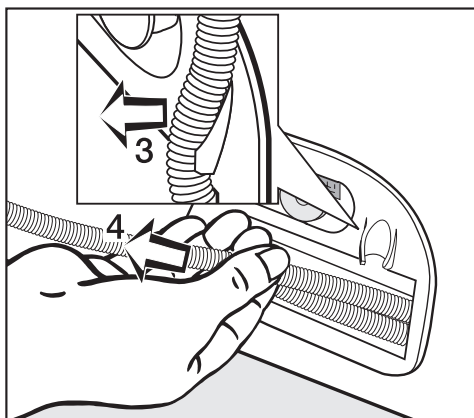

- Unclip the drain hose from clip (3).
- Then pull the drain hose **completely out of the dryer towards the left (4)** (See illustration). Important:

⚠ Do not let the drain hose become kinked, as this could damage it.

⚠ If you want to drain the water off into a sink you will need to secure the hose carefully, e.g. by tying it to a tap to make sure it cannot slip during use. Otherwise there is a risk of overflowing water which could cause damage.

Use the bow-shaped guide to prevent the drain hose from becoming kinked (see "Front view" illustration).

Installation

Connection to a sink drain outlet

The drain hose can be connected directly to a sink drain outlet.

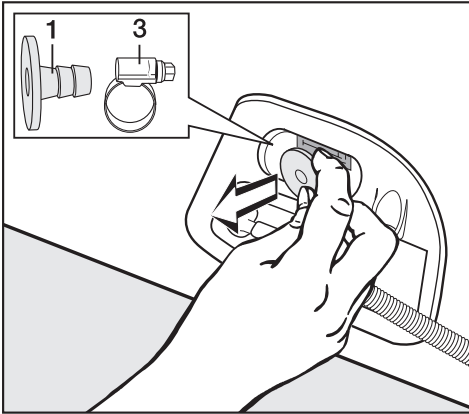

- Remove the following from the back of the dryer at the bottom:
Adapter **1** and hose clip **3** behind it.

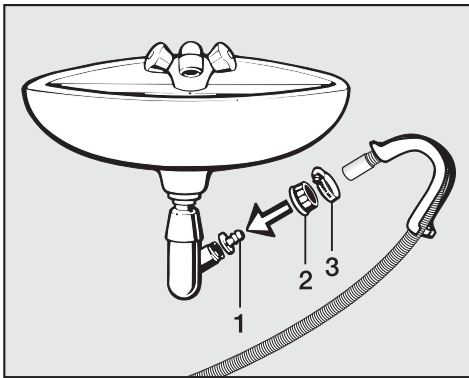

- Fit adapter **1** to the sink drain outlet using nut **2**.

If this nut has a flat disc in it you should take the disc out first. Important: if this nut has a washer or seal in it this must not be removed!

- Attach the end of the hose to adapter **1**.
- Use a screwdriver to tighten hose clip **3** up close to the nut.

If you no longer wish to use an external condensed water outlet

! Do not push the drain hose back into the dryer. Doing this could cause it to become kinked and damaged in the dryer.

- Loop the drain hose up.
- Use a suitable cable tie to secure the looped hose to the back of the dryer, or simply lay the looped hose behind the dryer.
- Attach the open end of the drain hose back onto the holder at the back of the dryer at the top (see holder **2** in "Pulling out the drain hose").

Electrical connection U.K.

All electrical work should be carried out by a suitably qualified and competent person, in strict accordance with national and local safety regulations.

Ensure power is not supplied to the appliance until after installation work has been carried out.

The appliance is supplied with a mains cable with moulded plug ready for connection to a 230-240V mains supply. **The voltage and connected load are given on the data plate.**

Please ensure these match the household mains supply. The fuse rating is quoted on the plug.

Connection should be made via a suitable switched socket which is easily accessible after installation.

For extra safety it is advisable to install a residual current device (RCD), with a trip current of 30 mA (in accordance with DIN VDE 0664, VDE 0100 Section 739).

Do not connect via an extension lead. Extension leads do not guarantee the required safety of the appliance (e.g. danger of overheating).

Non-rewireable plugs BS 1363

The fuse cover must be refitted when changing the fuse, and if the fuse cover is lost, the plug must not be used until a suitable replacement is obtained. The colour of the correct replacement cover is that of the coloured insert in the base of the plug, or the colour that is embossed in words on the base of the plug (as applicable to the design of plug fitted).

Replacement fuses should be ASTA approved to BS 1362 and have the correct rating. Replacement fuses and fuse covers may be purchased from your local electrical supplier.

**WARNING: THIS APPLIANCE
MUST BE EARTHED**

Consumption data

Programme	Load kg*	Final spin speed in a domestic washing machine	Energy kWh	Time Minutes
		rpm		
Cottons Normal	6.0	800 (70 % residual moisture)**	3.90	109
		1200	3.10	87
		1400	2.95	83
		1600	2.80	81
		1800	2.55	74
Cottons Hand iron	6.0	800 (70 % residual moisture)**	3.25	93
		1200	2.40	71
		1400	2.25	66
		1600	2.15	64
		1800	1.85	56
Minimum iron Normal	3.0	1000 (50 % residual moisture)**	1.50	47
Minimum iron Hand iron	3.0	1000	1.30	41
Delicates Normal	2.0	–	1.25	78
Automatic Normal	3.0	900	1.85	66
Shirts Normal	2.0	900	1.25	48
Denim Normal	3.0	800	1.75	52
Woollens hand care	2.0	900	0.15	4
Silks handcare	1.0	–	0.15	5
Smoothing	3.0	–	0.30	8
Sportswear Normal	2.0	–	1.40	50
Outerwear Normal	2.0	–	1.50	57
Proofing	2.0	–	1.60	56
Pillows	1.0	–	1.60	84
Large Pillows	1.2	–	1.60	98

* Weight of dry laundry

** EN 61121 test programme

All data established in accordance with EN 61121.

Before testing in accordance with EN 61121, dry a 3 kg load of cotton laundry with 70% residual moisture as per the above standard using the Cottons Normal programme without any Extra options.

Consumption data can vary from the nominal values given above depending on the size of the load, types of textiles, residual moisture levels after spinning, fluctuations in the electricity supply and any Extra options selected.

Technical data

Height	850 mm (adjustable +7 / -7 mm)
Height for building under	820 mm
Width	595 mm
Depth	580 mm
Depth with door open	1,060 mm
Weight	54 kg
Drum volume	100 litres
Maximum capacity	6 kg dry weight
Capacity of condensed water container	approx. 3.5 l
Hose length	2 m
Maximum delivery head	1 m
Maximum drain hose length	3 m
Length of connection cable	2 m
Voltage	see data plate
Connected load	see data plate
Fuse rating (UK)	see plug
Lamp wattage	see data plate
Energy consumption	see "Consumption data" section
Test certificates awarded	Radio / TV suppression, VDE

Settings menu for changing standard settings

The Settings menu is used to alter the dryer's electronics to suit different requirements.
Settings can be altered at any time.

Settings menu 🚩

To open the *Settings* menu

- 1 Switch the dryer on.
The entry menu showing the current time of day will appear after the machine has been switched on, until you select an option.



- 2 After a few seconds an additional line will appear in the display.

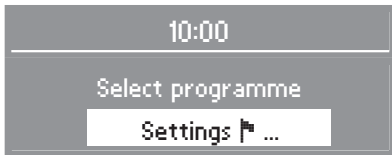

- 3 Select *Settings* and then press the OK button.
- 4 This will take you into the *Settings* menu.

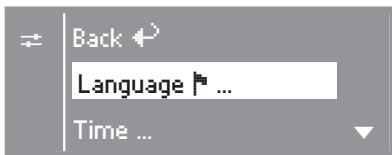

- 5 Use the - and + buttons to select the setting you want and confirm your selection by pressing the OK button.

The arrow ▼ in the display indicates that there are further options.

If you do not make a selection in the *Settings* menu and in its sub-menus within approx. 15 seconds, the display will revert to the previous menu.

To close the *Settings* menu

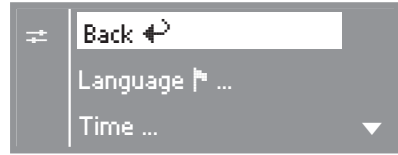

Select *Back* and confirm your selection with the *OK* button.

Language 🚩

The display can be set to appear in several different languages.

A tick ✓ will appear beside the language to show that it has been set.

The flag after the word *Language* acts as a guide to prevent a language which will not be understood from being set.

Time of day

First select either a 24 hour or 12 hour clock.

Then set the current time of day.

24 h clock

(the machine is delivered with this option selected)

12 h clock

The display will then switch to the screen for setting the time of day.



- Set the hour with the - and + buttons and confirm your setting by pressing the *OK* button. Now set the minutes. The display will return to the *Settings* menu.

Important: The time of day can also be set by pressing the ⊕ button after switching the tumble dryer on, before selecting a programme.

Drying levels

You can alter the drying levels for the *Cottons* and *Minimum iron* programmes.

The bar chart shows you the setting. The machine is delivered with a medium setting set as standard.

Depending on the setting, the programme duration will be shorter (Damper) or longer (Drier).

Extending the cooling down time

The cooling down phase which takes place before the end of a programme can be lengthened if required. This makes the garments easier to handle.

The bar chart shows you the setting. The machine is delivered with 0 mins (normal cooling down period) set as standard.

You can select an extended cool down time in 2 minute increments up to a maximum of 18 minutes.

You cannot extend the cooling down time for the Warm air, Cool air, Woollens Hand care or Smoothing programmes.

Settings menu 🏠

Airways indicator

Fluff should be removed after drying. The *Clean the filters* message will remind you to clean the filters when a certain amount of fluff has collected in the filters. You can decide at what level of fluff this reminder should be given.

You will have an idea of how often this should be done after a few drying programmes.

Off

Clean the filters does not appear

Heavy

Clean the filters only appears when there is a heavy build-up of fluff

Normal

Factory default setting

Light

Clean the filters appears when there is only a small build-up of fluff

A tick ✓ will appear beside the language to show that it has been set.

Lock

The system lock prevents your machine being used without your knowledge.

When the system lock has been activated, you have to enter a code after switching the dryer on. Otherwise the dryer cannot be operated.

The door is not locked and can be opened at any time.

To activate the lock

- Select *Activate* and confirm your selection.
- The display will now request that a code is entered. The code is **250** and cannot be altered.

To enter the lock code

The code is: **250**



- Use the **+** button to enter the first number. Confirm your selection of this number by pressing the *OK* button. Now set the second number.
- Repeat the process until all three numbers have been entered.
- After the last number has been entered, press the *OK* button.



- Confirm the code with the *OK* button or if you want to correct a mistake, press the – button.

The lock will now be activated when the dryer is switched off.

To unlock the dryer

When the machine is switched on again, the display will request the lock code.

- Enter lock code 250 as described above and confirm the entry.



The dryer is now unlocked.

To deactivate the lock

Proceed as for activating the lock.

Settings menu

Buzzer

The buzzer has two volumes.

Normal

The buzzer sounds at the end of a programme. (The machine is delivered with this option set as standard).

Loud

The buzzer sounds at maximum volume at the end of a programme.

The buzzer will always sound when there is a fault, even if it has been switched off.

A tick ✓ will appear beside the option to show that it has been set.

Display contrast

Display brightness

There are ten different display contrast and display brightness settings.

The bar chart shows you the setting.

Keypad tones

An audible tone sounds each time a button is pressed.

A tick ✓ will appear beside the option to show that it has been set. The machine is delivered with the option: Off set as standard.

Standby

To save energy, the display goes out after 10 minutes and the *Start/Stop* button will start flashing slowly.

There are two options:

Active (On)

Stand-by comes on:

- if a programme is not selected after the machine has been switched on.
- when the *Start/Stop* button is pressed.
- at the end of a programme.

Not in current prog.

Stand-by comes on:

- if a programme is not selected after the machine has been switched on.

Pressing one of the buttons switches the display back on again.

A tick ✓ will appear beside the option to show that it has been set. The machine is delivered with the option: On set as standard.

**United Kingdom:**

Miele Co. Ltd.
Fairacres, Marcham Road
Abingdon, Oxon, OX14 1TW
tel. Abingdon (01235) 554455
Service Office: (01235) 554466
fax (01235) 554477
Internet: www.miele.co.uk

Ireland:

Miele Ireland Ltd.
Broomhill Road, Tallaght, Dublin 24
Tel: (01) 46 10 710, Fax: (01) 46 10 797
Email: info@miele.ie
Internet: <http://www.miele.ie>

Australia:

Miele Australia Pty. Ltd.
A.C.N. 005635398
1 Gilbert Park Drive
Knoxfield, VIC 3180
Telephone: (03) 9764 7100
Fax: (03) 9764 7129
Internet: www.miele.com.au

Distributor New Zealand:

Steelfort Engineering Company. Ltd.
500 Rangitikei Street
Palmerston North, Priv. Bag 11045, NZ
Telephone: (06) 350 1350
Fax: (06) 356 1507

South Africa:

Miele (Pty) Ltd
63 Peter Place
Bryanston 2194
P.O. Box 69434
Bryanston 2021
Tel.: (011) 548 1900
Telefax (011) 548 1935
Internet: www.miele.co.za
E-mail: info@miele.co.za

Singapore:

Miele Southeast Asia
Miele Pte. Ltd.
163 Penang Road
04 - 02/03 Winsland House II
Singapore 238463
Tel : +65-67351191
Fax: +65-67351161
Email: infosea@miele.com.sg

Hong Kong:

Miele (Hong Kong) Limited
AIA Plaza, 24th Floor
18 Hysan Avenue
Causeway Bay
Hong Kong
Tel.: (852) 2610 1331
Fax: (852) 2610 1013
E-mail: mielehk@miele.com.hk

Free Manuals Download Website

<http://myh66.com>

<http://usermanuals.us>

<http://www.somanuals.com>

<http://www.4manuals.cc>

<http://www.manual-lib.com>

<http://www.404manual.com>

<http://www.luxmanual.com>

<http://aubethermostatmanual.com>

Golf course search by state

<http://golfingnear.com>

Email search by domain

<http://emailbydomain.com>

Auto manuals search

<http://auto.somanuals.com>

TV manuals search

<http://tv.somanuals.com>