

Operating instructions

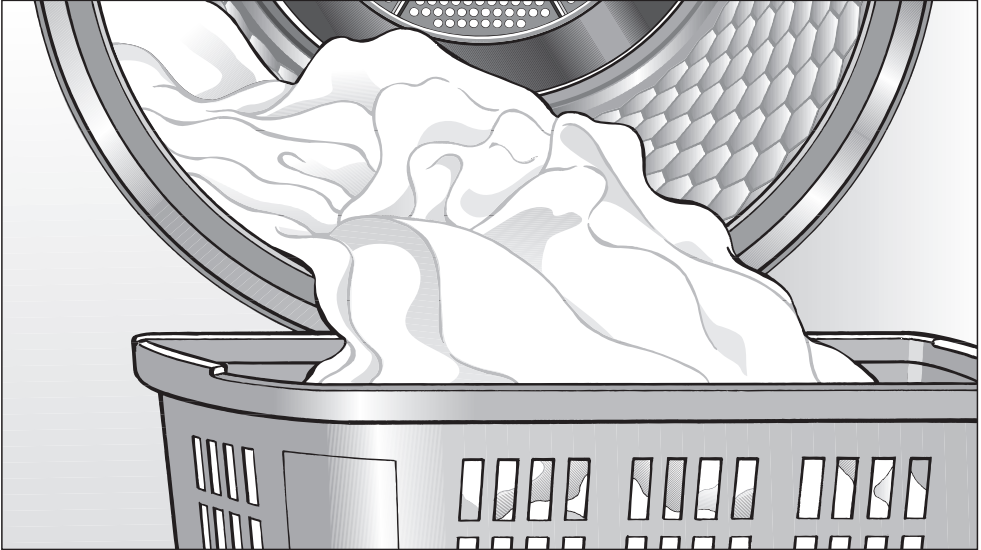

for heat pump tumble dryer T 8007 WP SUPERTRONIC

To avoid the risk of accidents or damage to the appliance it is **essential** to read these instructions before it is installed and used for the first time.

en - GB

M.-Nr. 09 459 300

Caring for the environment

Disposal of the packing material

The transport and protective packing has been selected from materials which are environmentally friendly for disposal and should be recycled.

Ensure that any plastic wrappings, bags, etc. are disposed of safely and kept out of the reach of babies and young children. Danger of suffocation.

Disposing of your old appliance

Electrical and electronic appliances often contain materials which, if handled or disposed of incorrectly, could be potentially hazardous to human health and to the environment. They are, however, essential for the correct functioning of your appliance. Please do not therefore dispose of it with your household waste.

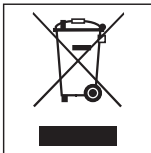

Please dispose of it at your local community waste collection / recycling centre or contact your dealer for advice.

Ensure that it presents no danger to children while being stored for disposal.

Energy saving tips

To avoid unnecessarily long drying times and high consumption of energy:

- Make sure that your laundry is thoroughly spun before drying. The higher the spin, the greater the savings that can be made in energy and time during drying.
- Load according to the optimum amount of laundry recommended for the programme being used. Underloading is uneconomical. Overloading gives a poorer quality of drying, and may cause unnecessary creasing.
- Make sure that the room temperature is not too high. If there are other heat producing appliances in the room in which the dryer is located, make sure the room is well ventilated and switch the other appliances off, if possible.
- After every cycle remove fluff from the surfaces of the fluff filters.

Caring for the environment	2
Warning and Safety instructions	6
Operating the tumble dryer	14
Control panel	14
Selector sensors	15
Structure of the main menu	17
Miele@home	19
Before using for the first time	21
Notes on laundry care	23
Garment care label symbols	23
Tips on drying	23
1. Sort the laundry and loading the drum	24
2. Select a programme	25
Switch the dryer on with the Ⓛ button	25
– Programmes with drying levels (sensor drying)	25
– Programmes which operate by time	26
– Other programmes	26
Select an extra option	27
Start at / Finish at	27
3. Start the programme	28
Starting a programme	28
Time left	28
Selecting a different programme	28
Start at / Finish at: Changing the time of day	28
Cancelling a programme	29
Adding or removing laundry after a programme has started	29
4. End of the programme - unload the drum	30

Contents

Extra options	31
Freshen up	31
Gentle tumble	31
Favourite programmes	32
Programme chart	34
Cleaning and care	39
Emptying the condensed water container	39
Make sure you clean all the filters at the correct intervals	40
When to clean the surfaces of the fluff filters	40
When to clean the fine filter	40
Cleaning the surfaces of the fluff filters	41
Cleaning them whilst dry	41
Cleaning with water	42
Replacing the filters	42
Fine filter	43
Removing the fine filter	43
Cleaning the fine filter	43
Cleaning the cover for the fine filter	44
Cleaning the heat exchanger	44
Replacing	45
Cleaning the tumble dryer	45
Problem solving guide	46
Check and fault messages in the display	46
An unsatisfactory drying result	49
Other problems	50
Cleaning the cooling fins (bottom right grille)	52
Changing the lamp	53
After Sales service	54
Repairs	54
Future updates (PC)	54
Appliance guarantee	54
Optional accessories	54

Installation and connection	55
Front view	55
Rear view	56
Transporting the dryer	56
Installation site	57
Building under a continuous worktop/ in a row of kitchen units	57
Levelling the appliance.	58
Washer-dryer stack.	58
External condensed water outlet	59
Arranging the drain hose	59
External drainage via a sink or gully	60
Installation conditions requiring a non-return valve	60
Electrical connection	62
Electrical connection U.K.	62
Consumption data	63
Technical data	64
Settings menu	65
Open the Settings menu	65
Language 	65
Time	66
Drying levels	66
Code	67
Buzzer	69
Keypad tone	69
Brightness	69
Contrast	69
Display / keypad illumination	69
Memory	70
Anti-crease.	70
Optional accessories	71

Warning and Safety instructions

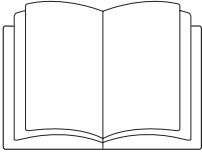

► It is **essential** to read these instructions.

This tumble dryer conforms to current safety requirements. Inappropriate use can, however, lead to personal injury and damage to property.

To avoid the risk of accidents and damage to the tumble dryer, please read these instructions carefully before using it for the first time. They contain important information on its safety, installation, use and maintenance.

Keep these instructions in a safe place and ensure that new users are familiar with the content. Pass them on to any future owner.

Correct application

► This tumble dryer is not designed for commercial use. It is intended for use in domestic households and similar working and residential environments.

► The tumble dryer is not intended for outdoor use.

► It must only be used as a domestic appliance to dry items which have been washed in a water solution and which are marked on the manufacturer's care label as being suitable for tumble drying. If using dry cleaning kits, do so at your own risk, and follow the instructions provided on the packaging.

Any other usage is not supported by the manufacturer and could be dangerous. Miele cannot be held liable for damage resulting from incorrect or improper use or operation.

Warning and Safety instructions

▶ The tumble dryer can only be used by people with reduced physical, sensory or mental capabilities, or lack of experience or knowledge, if they are supervised whilst using it or have been shown how to use it in a safe way and understand the hazards involved.

Safety with children

▶ Children under 8 years of age must be kept away from the tumble dryer unless they are constantly supervised.

▶ Children 8 years and older may only use, clean or maintain the tumble dryer without supervision if they have been shown how to do so in a safe way and understand the hazards involved.

▶ The tumble dryer is not a toy! To prevent the risk of injury, do not allow children to play with it or near it, or to play with the controls.

Warning and Safety instructions

Technical safety

▶ Before setting up the tumble dryer, check it for any externally visible damage.

Do not install or use a damaged tumble dryer.

▶ Before connecting the tumble dryer, ensure that the connection data on the data plate (voltage and frequency) match the mains electricity supply. If in any doubt, consult a qualified electrician.

▶ The electrical safety of this tumble dryer can only be guaranteed when correctly earthed. It is most important that this basic safety requirement is observed and regularly tested, and where there is any doubt, the household wiring system should be inspected by a qualified electrician. Miele cannot be held liable for the consequences of an inadequate earthing system (e.g. electric shock).

▶ Do not connect the tumble dryer to the mains electricity supply by an extension lead. Extension leads do not guarantee the required safety of the tumble dryer (e.g. danger of overheating).

▶ If the electrical connection cable is faulty it must only be replaced by a Miele approved service technician to protect the user from danger.

▶ Unauthorised repairs could result in unforeseen dangers for the user, for which Miele cannot accept liability. Repairs should only be undertaken by a Miele approved service technician, otherwise any subsequent damage will not be covered by the guarantee. Ensure current is not supplied to the tumble dryer until after maintenance or repair work has been carried out.

▶ Faulty components must only be replaced by genuine Miele original spare parts. Only when these parts are fitted can the safety standards of the tumble dryer be guaranteed.

Warning and Safety instructions

- ▶ The tumble dryer must be isolated from the electricity supply in the event of a fault and during cleaning and maintenance.
- ▶ The tumble dryer must not be used in a non-stationary location (e.g. on a ship).
- ▶ Do not make any alterations to the tumble dryer, unless authorised to do so by Miele.
- ▶ Heat pump technology and refrigerant:
The heat pump in this tumble dryer uses a refrigerant which is condensed by the compressor and led in a closed circuit through the heat exchanger unit where heat exchange with the circulating drying air takes place.
 - The humming noises caused by the heat pump are normal and do not impair the efficient functioning of the dryer.
 - The refrigerant is not flammable or explosive.
 - In general it is not necessary to leave the dryer standing for any length of time before it is put into operation provided it has been transported correctly (see "Installation").
However, if it has not been transported as described, ensure that the recommended standing time prior to first operation is observed. Otherwise the heat pump can be damaged.
- ▶ In areas which may be subject to infestation by cockroaches or other vermin, pay particular attention to keeping the tumble dryer and its surroundings in a clean condition at all times. Any damage which may be caused by cockroaches or other vermin will not be covered by the guarantee.

Warning and Safety instructions

Correct use

- ▶ To prevent the risk of fire, the following textiles must not be dried in this appliance:
- items which have not been washed.
 - items, such as workwear, which have not been thoroughly cleaned and which are still soiled with grease, oil or other deposits (such as cosmetics, lotions etc).
If items have not been thoroughly cleaned there is a danger that these might self-ignite when heated, even after they have been removed from the dryer at the end of the programme.
 - items (e.g. mops and floor cloths) which have been treated with inflammable cleaning agents or which contain residues of acetone, alcohol, benzine, petrol, kerosene, stain remover, turpentine, wax and wax remover or other chemicals.
 - items which have been splashed with hair lacquer, hair spray, nail varnish remover or similar substances.

When washing such heavily soiled items, ensure that you use additional detergent and select a high temperature. If in doubt, wash the items several times.

- ▶ Remove all items such as lighters and matches from pockets.
- ▶ **Warning:** Do not switch the tumble dryer off before the drying programme has finished. If this is done, the laundry must be hung up or spread out to cool it down.

Warning and Safety instructions

▶ Danger.

This tumble dryer must not be connected to a controllable socket (e.g. a timer switch or a peak load shut-off device).

If the dryer programme were to be interrupted before the end of the cooling down phase, the laundry could self-combust.

▶ To prevent the risk of fire, the following must not be tumble dried:

- items which have been cleaned using chemicals (e.g. professional dry-cleaning agents).
- fabrics which contain a large proportion of rubber, foam rubber or rubber-like materials. For example, products made from latex foam rubber, shower caps, waterproof textiles, rubberised articles and items of clothing and pillows with foam rubber filling.
- damaged items which contain padding or fillings (e.g. pillows, jackets). When damaged, the filling can get out with the risk of igniting in the dryer.

▶ In many programmes, the heating phase is followed by a cooling down phase to ensure that the items are not too hot to handle when you remove them (this also avoids the danger of the laundry self-igniting). The programme is not finished until the cooling down phase has been completed.

As soon as the programme has finished, remove all laundry from the drum.

▶ Fabric conditioner and similar products must be used according to the instructions on the manufacturer's packaging.

▶ Do not let anyone sit or lean on the door, as this can cause the tumble dryer to tip up.

▶ Always close the door after use. This way you will avoid the danger of:

- children climbing into the dryer or hiding things in it.
- pets or other small animals climbing into it.

Warning and Safety instructions

- ▶ The tumble dryer must not be used:
 - without the fluff filters in place or if the fluff filters are damaged in any way.
 - without the fine filters in place or if the fine filters are damaged in any way.

This would cause an excessive build-up of fluff which in turn would cause a fault.

- ▶ After every cycle remove fluff from the surfaces of the fluff filters.
- ▶ The fluff filters and the fine filters must be thoroughly dried after cleaning. Damp or wet filters could cause operational faults.
- ▶ Do not install the tumble dryer in a room where there is a risk of frost occurring. At temperatures around freezing point the tumble dryer may not be able to operate properly. There is a risk of damage if the condensed water is allowed to freeze in the pump and in the drain hose.
- ▶ If the water is drained externally instead of being collected in the condensed water container, make sure the drain hose is securely attached if you hang it in a sink or basin to avoid the hose slipping and the water causing damage.
- ▶ Condensed water is not drinking water. It can cause health problems in both people and animals.
- ▶ Always keep the area around the tumble dryer free of dust and fluff. Dust drawn into the tumble dryer can cause blockages in the heat exchanger unit over time.
- ▶ The tumble dryer must not be hosed down.

Accessories

► Only use genuine Miele original spare parts and accessories with this tumble dryer.

If non-Miele parts are used, guarantee, performance and product liability claims may be invalidated.

Miele cannot be held liable for damage caused by non-compliance with these Warning and Safety instructions.

Operating the tumble dryer

Control panel

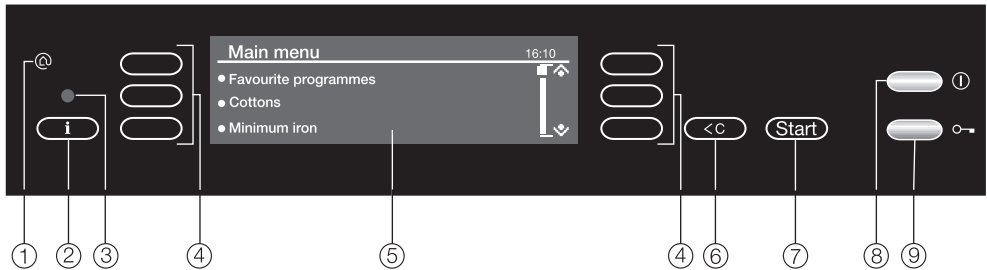

① Miele@home

Symbol for Miele@home enabled appliance

② Information sensor **i**

The sensor lights up when information about the menu in the display is available.

③ Service interface

This is used by service technicians to run diagnostic checks on your machine, or to update programming data in the future.

④ Selector sensors

A sensor is active when it is lit up. See next page for more information.

⑤ Display

For showing:

- the functions selected
- the programme sequence
- information
- error messages
- the time of day
- the position of an entry using the scroll bar

⑥ Clear sensor <C

- For returning to the previous menu.
- For returning to the main menu when touched twice.
- For deleting the values set previously.
- For cancelling the programme.

⑦ Start sensor

The programme selected is started by touching this sensor when it is illuminated green.

⑧ **ⓘ** button

For switching the dryer on and off. To save energy the dryer will switch off automatically 15 minutes after the end of the programme/anti-crease phase or 15 minutes after the dryer is switched on if it is not operated.

⑨ **⏏** button

For opening the door. The dryer does not need to be switched on at the mains.

Selector sensors

The selector sensors are on the left and right of the display. They light up when they are active. The selector sensors are used for the following:

Selecting an option

A dot (•) next to an option indicates that it can be selected. The selector sensor on the left is active when the dot (•) is in front of the word, the selector sensor on the right is active when the dot (•) is behind the word or symbol.

Scrolling through the menus

If the menu lists more options than are visible in the display, a scroll bar will appear on the right to show the position in the list:

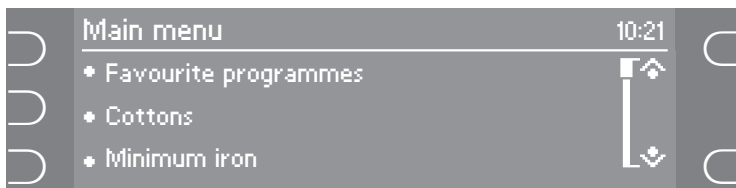

The sensors on the right can be used to scroll up or down the list. Each touch of the sensor will move the list up or down one line.

A dotted line will appear under the last option in the list.

Changing a value in the display

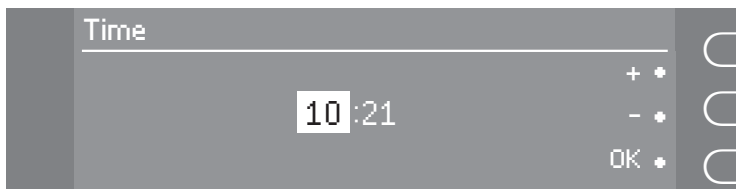

Use the + and - sensors on the right to alter the value highlighted. Once altered confirm the value with the **OK** sensor at the bottom right hand side.

Operating the tumble dryer

Favourite programmes

You can save up to ten of your own customised programmes under names of your choice.

Drying assistant

This helps you find the correct wash programme. The drying assistant guides you step by step so that you can select the best programme for the fabrics and garments you want to dry.

Settings menu













The *Settings* menu  is used to alter the tumble dryer's electronics to suit different requirements. See "Settings menu" for more details.

Information sensor **i**

The Information sensor **i** will light up if information about an option is available. Touch the sensor if you want to read the information.

Programme sequence display

Symbols in the display show which section of the programme has been reached.

Symbol	Programme sequence
	Start at / Finish at
	Drying
	Machine iron
	Hand iron 
	Hand iron 
	Normal
	Normal+
	Cooling down / Cancel
	Cool air
	Warm air
	Anti-crease/Finish

Structure of the main menu

Favourite programmes	
	<ul style="list-style-type: none">- Favourite programmes (listed alphabetically)- Create- Change- Delete
Cottons	
<ul style="list-style-type: none">- Minimum iron- Delicates--	<ul style="list-style-type: none">- Drying level: (depending on programme)- Duration (depending on programme)- Extras (depending on programme)- Start at- Finish at
Drying tips	
	<ul style="list-style-type: none">- Cottons*- Delicates*- Cotton + synthetic*- Woollens- Silks- Microfibre*- Linen*

* This option has further choices.

Operating the tumble dryer

Settings ▾

- Language ▾
- Time*
- Buzzer
- Drying levels*
- Code
- Keypad tone
- Brightness
- Contrast
- Display / keypad illumination
- Memory
- Anti-crease
- Miele@home**
- Remote control**

* This option has further sub-menus.

** Appears if the dryer has been fitted with the optional communication module.

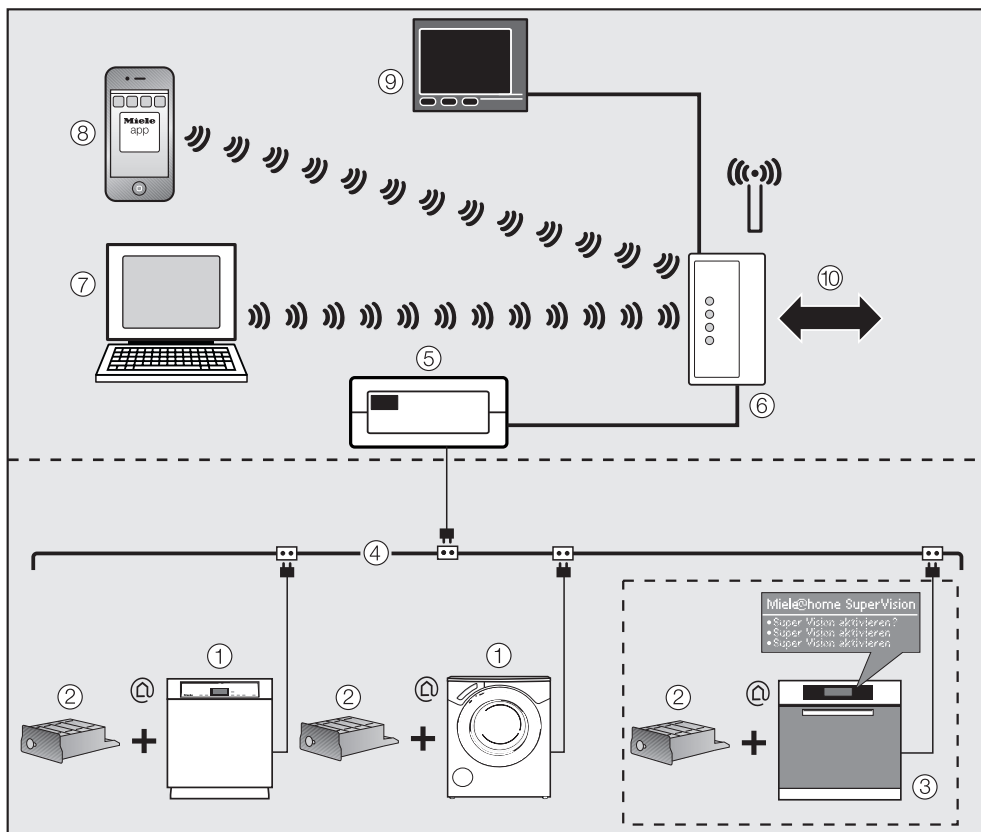

① Communication-enabled appliances

② Communication module

③ SuperVision master appliance

④ Power supply

⑤ Miele@home Gateway

⑥ (WLAN) Router

Possible connections (optional)

⑦ PC, Notebook

⑧ iPod* or iPhone*

⑨ Connection with a domestic bus system display

⑩ Possible internet connection

* iPod and iPhone are registered trade marks of Apple Inc.

Depending on country, this appliance is communication enabled and can be linked into the Miele@home system via a communication module ② (optional accessory).

Miele@home enabled appliances send information via the household power supply network ④ to the master appliance ③ about the operational status of the appliances, as well as information about the progress of the programme.

Displaying information, controlling appliances

- SuperVision master appliance ③
The status of other communication enabled appliances in the system can be shown in the display of the SuperVision master appliance.
- Mobile terminal appliances ⑦/⑧
A PC, Notebook or an iPod* / iPhone* can be used within the operating radius of a WLAN to display status information about the networked appliances and to carry out some operational commands.
- Household network ⑨
Miele@home enables smarter living. With the Miele@home Gateway ⑤ communication-enabled appliances can be integrated into the domestic bus system.

* iPod und iPhone are registered trade marks of Apple Inc.

Optional accessories required

- Communication module
This must be fitted by a Miele service technician.
- Miele@home Gateway

Both of these are supplied with their own installation and operating instructions.

Further information

For further information about Miele@home, SuperVision and future options please contact Miele.

Before using for the first time

Before using the dryer for the first time ensure that it is correctly installed and connected. See "Installation".

 If the tumble dryer has not been transported as described in "Installation" then it must be left to stand for at least 1 hour before it is connected to the electricity supply. Otherwise the heat pump may become damaged.

Preparing the dryer for use is done in five steps. The dryer guides you automatically through steps **1.** to **5.**

1. Welcome screen

- Switch the dryer on with the  button.

The welcome screen will appear in the display for 3 seconds. The display for setting the language will then appear.

2. Set the language



- Select the language you want.
- The sensors on the right can be used to scroll up or down the list.
- Confirm the language you have selected with **OK**.

Before using for the first time

3. Set the time of day (if required)

Enter the time of day.



- Use **+** and **-** to set the hour.
- Confirm with **OK**. Then set the minutes and confirm with **OK**.

4. Miele@home message

This communication enabled dryer can transmit programme data through the power lines to the Miele@home system if it has been fitted with a communication module (optional accessory).

- Confirm the message with **OK**.





5. Continue setting the dryer up as described in the Operating instruction manual.

The dryer is correctly set up once a programme lasting longer than one hour has been run (See "2. Selecting a programme").

The welcome screen and request to set the language will appear in the screen after switching the dryer on again if a programme lasting less than 1 hour was run.

- Confirm the message with **OK**.

Garment care label symbols

Drying	
	Normal/low temperature Drying is carried out at a low temperature in every programme, so you do not need to sort your garments according to whether they have the  or  symbol.
	Do not tumble dry

Tips on drying

- Always observe the maximum recommended loads given in the "Programme chart". Never overload the drum.

Overloading can cause unnecessary wear and tear to the laundry, give a disappointing drying result and cause more creasing.

- Do not put soaking wet items into the tumble dryer. Spin fabrics for at least 30 seconds before drying.
- Use the *Automatic plus* programme for drying mixed loads of cotton and minimum iron fabrics.
- Open jackets so that they can dry evenly.
- Pure linen should only be machine dried if specified as suitable by the manufacturer on the garment care label, as the surface of the fabric may otherwise become rough.

- Loopknit garments (e.g. T-shirts and underwear) tend to shrink depending on their quality. Do not over-dry these textiles. When purchasing these garments it is advisable to take their shrinkage properties into account.

- Minimum iron fabrics tend to crease more, the larger the load. This is also the case for garments made from very fine weave fabrics, such as shirts or blouses.

Make sure you select a suitable programme. If in doubt, divide the garments into smaller loads and select the *Gentle tumble extra* option.

- Starched laundry can be dried in the tumble dryer. To achieve the usual finish, double the amount of starch should be used.

- New dark coloured garments should be washed and dried separately from light coloured garments to avoid the danger of colours running and discolouring other garments or even plastic components in the dryer. Dark coloured fibres can also settle on light coloured garments and vice versa.

- Use the *Drying basket programme* for drying / airing items which are not suitable for drying with mechanical action. Important: You must use a Miele drying basket (optional accessory).

1. Sort the laundry and loading the drum

Prepare the laundry

To ensure an even drying result sort the washed laundry according to:

- ...
- ... the drying level required,
- ... the type of fibre or weave,
- ... size,
- ... the moisture content after spinning.

 Make sure that objects, e.g. detergent dispensing balls, have been removed from the laundry. They could melt and cause damage to the dryer or the laundry.

- Check seams and stitching to ensure that padding and linings are intact.
- Fasten duvet covers, pillow cases etc. to prevent small items from being rolled up inside them.
- Fasten zips, hooks and eyes etc.
- Tie fabric belts and apron strings.
- Sew in or remove underwiring from bras.

Load the tumble dryer

- Press the  button to open the door.
- Load the laundry loosely into the drum.

Do not overload the drum. See the "Programme chart" for recommended loads for each programme. Overloading can cause unnecessary wear and tear to the laundry, and give a disappointing drying result.

- Before closing the door make sure the fluff filter is correctly positioned.

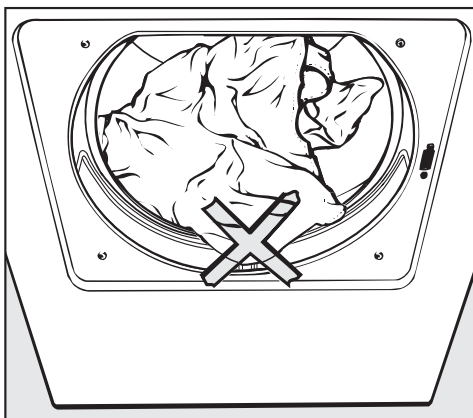

Check the laundry is right inside the drum so that it cannot get trapped or damaged when the door is shut.

- Shut the door either with a gentle swing, or lean against it and push it shut.

2. Select a programme

Switch the dryer on with the ① button



- Select the programme you want: Use the right hand sensors to show more programmes.

An additional menu may appear depending on the programme selected:

– Programmes with drying levels (sensor drying)

e.g. *Cottons* ... : You have a choice of drying levels with this programme.

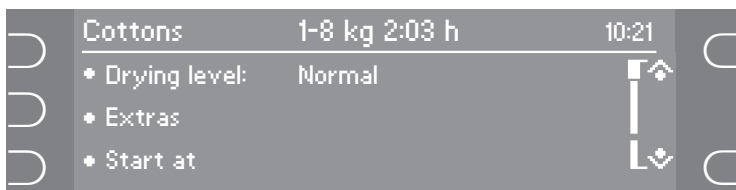

- Touch the *Drying level* sensor.



- If there are more than 3 levels to choose from: Use the right hand sensors to show more levels.
- Touch the left hand sensor to confirm the drying level required.
- Confirm with **OK**.

2. Select a programme

– Programmes which operate by time

e.g. *Warm air ...* : You have to select a duration.

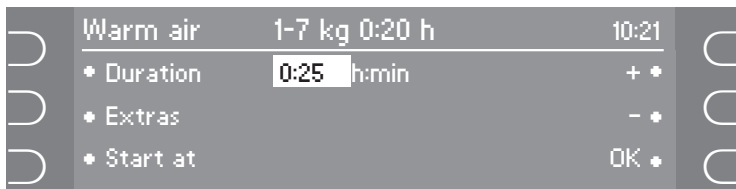

- Touch the *Duration* sensor.
- Use the + and - sensors on the right to alter the value which is highlighted.
- Confirm the value you have set with **OK**.
 - *Cool air*: 20 mins - 1 hour
 - *Warm air*: 20 mins - 2 hours
 - *Basket programme*: 40 mins - 2:30 hours

– Other programmes

e.g. *Gentle smoothing ...* : These programmes have fixed drying levels / durations and cannot be altered.

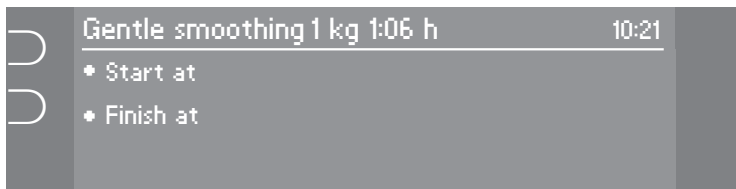

2. Select a programme

Select an extra option

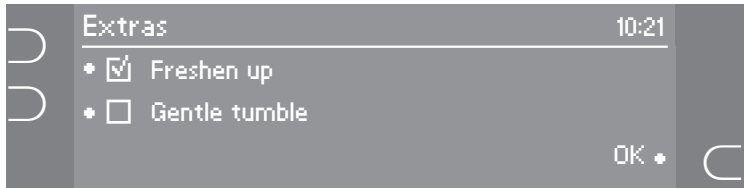

- Select the Extra you require.

When you select

- *Freshen up* the items are aired until they are at the *Normal* drying level.
- *Gentle tumble* drum rotation is reduced for less mechanical action.

A tick will appear to show which Extra has been selected.

- Confirm with **OK**.

Start at / Finish at

You can set the start (Start at) or the end (Finish at) time of a programme.

The start and end time can be set in steps of 15 minutes. You can delay the programme start time or the programme end time up to a maximum of 24 hours. With the first 15 minute step the time will be adjusted to the next quarter of an hour.

- Select the *Start at* or the *Finish at* option.

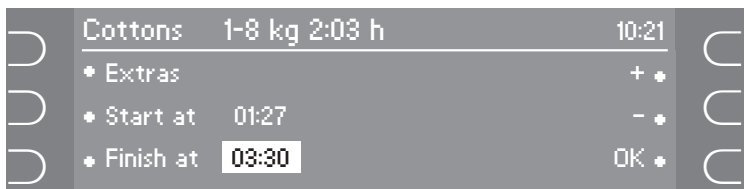

- Use **+** and **-** to select the time you want for *Start at* or *Finish at*. Confirm the time you have selected with **OK**.

Please note: Selecting or deselecting an Extra or altering the drying level subsequently, can postpone the programme end time.

3. Start the programme

Starting a programme

- Touch the green illuminated *Start* sensor.

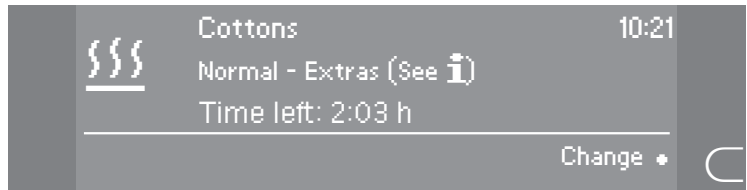

- The time left counts down in the display.
- Symbols in the display show which section of the programme has been reached.

Time left

The following factors all affect the estimated time left: the residual moisture after spinning; the type of textile; the load; the ambient room temperature; fluctuations in the power supply or a programme interruption.

The time left is continually monitored and altered during drying. This is why the time shown in the display may fluctuate during the programme. This is quite normal. Programmes can also finish earlier than expected, if, for example, particularly fine fabric is being dried, the load is very small or items were partially dry beforehand.

Some changes can be made after starting a programme:

Selecting a different programme

You cannot change to another programme once a programme has started (this prevents unintentional alterations).

You will need to cancel the current programme before you can select a new one.

Start at / Finish at: Changing the time of day

- Touch the *Change* sensor.
- Select the *Start at* or the *Finish at* option.
- Use **+** or **-** to alter the time of day.
- Confirm the time you have selected with the **OK** sensor.

3. Start the programme

Cancelling a programme

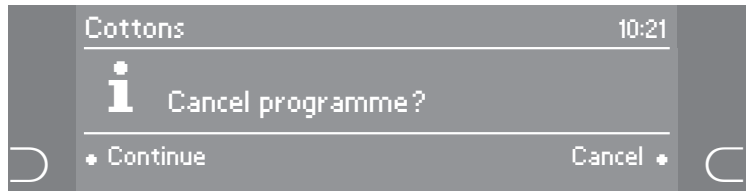

- Touch the <C sensor.



- Select *Cancel*.

The items will be cooled down , depending on the temperature reached and how long they have been dried for.

If you select <C and *Cancel* again,  *Finish* will appear in the display.

- Press the  button to switch the dryer off.
- Press the  button to switch the dryer on.
- Select another programme and start it.

An alternative way to cancel

- Press the  button.

Adding or removing laundry after a programme has started

- Press the  button.
- Open the door.
- Add or remove items as required.
- Close the door.
- Select a programme.
- Touch the *Start* sensor.

4. End of the programme - unload the drum

Before the end of a programme

There is a cooling down phase at the end of the drying sequence:  (= Cooling down) appears in the display. The programme is not finished until the cooling down phase has been completed.

End of the programme - unload the drum

 *Anti-crease* and *Finish* will appear in the display to indicate that the programme has finished. The buzzer will sound at intervals.

The dryer has an energy saving mode: After the programme has finished, the display will go out and the *Start* sensor will flash slowly (see also "Settings menu - Display / Keypad illumination". During the *Anti-crease* phase, the drum will rotate at intervals to prevent laundry creasing. This is quite normal.

- Press the  button to open the door.
- Remove the laundry.

Check that all items have been removed from the drum. If items are left in the dryer, they could be damaged by overdrying when the dryer is next used.

The dryer will switch off automatically 15 minutes after the end of a programme / the end of the anti-crease phase.

(If the dryer is signed on to the Miele@home system, it will not switch off automatically).

- Press the  button to switch the dryer off.

The buzzer will sound.

- Close the door.
- Empty the condensed water container unless the dryer has been connected for external drainage, in which case it does not have to be emptied.

Drum lighting

To give a good view of the inside of the drum so that no items are overlooked:

The lighting comes on when the door is opened if the dryer is switched on. It will go out after a short while if the door is left open and after the door is closed to save energy.

Freshen up

The drying air is heated up for a specific length of time. After this, the garments are aired to the *Normal* drying level without any more heat being added.

Use the *Freshen up* extra option to eliminate or reduce unwanted smells in clean (dry or damp) clothing. Items must be suitable for drying in a tumble dryer. Dampen the garments a little beforehand or add a fabric conditioner sheet. Odours will not be removed as effectively from any parts of the garments which are made of synthetic fibres.

Gentle tumble

For drying items which can be dried in a tumble dryer but which are particularly susceptible to creasing or which are not suitable for drying with a great deal of mechanical action. When this option is selected, the drum will rotate less frequently.

The programme duration is longer.

Note

You can alter the drying levels for some programmes (see "Settings menu").

This dryer also has a buzzer and an anti-crease phase at the end of the programme which can be altered (see "Settings").

Optional extras

This dryer offers the following extras:

	Freshen up	Gentle tumble
Cottons	•	•
Minimum iron	•	•
Shirts	•	•
Denim	•	•
Sportswear		•
Warm air		•

However, you have to choose either the *Freshen up* or *Gentle tumble* option.

Favourite programmes

You can save up to ten programmes with the settings you have selected for them under names of your choice. The name can have up to 12 characters.

The favourite programmes which have been set are stored alphabetically.

To save a favourite programme

There are two ways of saving a programme as a favourite.

1. Open the *Favorite programmes* menu and select *Create*. You can then select a programme in the usual way.
2. If you alter a drying level or select an Extra when you select the programme: Also select *Save as*.

To enter a name for a favourite programme



- Select the first character and confirm this with *Select character*. Use the  sensor to scroll to the right to select the rest of the characters.
- After the first letter in upper case has been entered the display will change automatically to display letters in lower case. After a space has been entered the display will revert to upper case again.

To save a name for a favourite programme

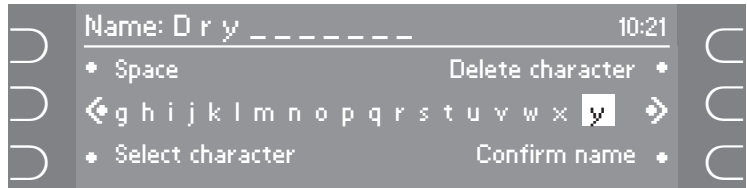

- Select *Confirm name*.

To select a favourite programme

- Call up the *Favorite programmes* menu. The saved programmes will appear in alphabetical order.
- Select the favourite programme you want.
- Touch the green illuminated *Start* sensor. The programme will start.

To change a favourite programme

- Select the *Change* option.
- Select the favourite programme you wish to change.
- Make any changes and then save it under the same name. The altered parameters will be active the next time the favourite programme is started.

To delete a favourite programme

If you have already saved ten favourite programmes then you will have to delete one of them before you can save a new programme.

- Select the *Delete* option.
- Select the favourite programme you wish to delete.
- Confirm the deletion.

Programme chart

Cottons		Max. load 8 kg*
Extra dry, Normal+, Normal**		
Use for	Single and multi-layered cotton fabric such as Towelling, T-shirts, underwear, flannelette bed linen and baby clothes.	
Notes	<ul style="list-style-type: none"> – Select <i>Extra dry</i> for multi-layered and very thick fabrics. – Do not use <i>Extra dry</i> for loopknit fabrics (e.g. T-shirts, underwear, baby clothes), as they have a tendency to shrink. 	
Hand iron Δ, Hand iron ΔΔ, Machine iron		
Use for	Cotton or linen fabrics e.g. Table linen, bed linen, starched laundry.	
Note	To prevent laundry from drying out, it should be rolled up until you are ready for ironing.	
Minimum iron		Max. load 3.5 kg*
Normal+, Normal, Hand iron Δ		
Use for	Minimum iron cotton, synthetic and mixed fibre fabric. e.g. tops, dresses, trousers, skirts and table cloths.	
Delicates		Max. load 2.5 kg*
Normal+, Normal, Hand iron Δ, Hand iron ΔΔ		
Use for	Synthetic, mixed fibre, rayon and easy care cotton, e.g. shirts, blouses, lingerie and appliquéd garments.	

* Weight of dry laundry

Note for test institutes:

- ** Test programme (without selecting any Extra options) in accordance with Regulation 392/2012/EU for energy labelling measured in accordance with EN 61121.
- When selecting the *Cottons* programme, drain the condensed water away through the drainage hose.

Programme chart

Automatic plus		Max. load 5 kg*
Normal+, Normal, Hand iron Δ		
Use for	Mixed loads of garments suitable for the <i>Cottons</i> and <i>Minimum iron</i> programmes. Sort according to colour.	
Shirts		Max. load 2 kg*
Normal, Hand iron Δ		
Use for	Shirts and blouses.	
Denim		Max. load 3 kg*
Normal, Hand iron Δ		
Use for	Denim garments, e.g. jeans, jackets, skirts, shirts.	
Express		Max. load 3.5 kg*
Extra dry, Normal+, Normal, Hand iron Δ, Hand iron ΔΔ, Machine iron		
Use for	Fabrics which can tolerate high temperatures and which can be dried using the <i>Cottons</i> programme.	
Note	– Short programme duration.	
Woollens		Max. load 2 kg*
Use for	Woollen garments and fabrics containing wool blends.	
Notes	<ul style="list-style-type: none"> – This programme only fluffs up woollen garments. They are not dried completely. – Remove garments as soon as the programme has finished. 	
Silks		Max. load 1 kg*
Use for	Silks (those suitable for drying in a tumble dryer), e.g. blouses and shirts.	
Notes	<ul style="list-style-type: none"> – Smooths out creasing. – Remove garments as soon as the programme has finished. 	

* Weight of dry laundry

Programme chart

Sportswear		Max. load 3 kg*
Normal+, Normal, Hand iron Δ		
Use for	Sportswear which is suitable for drying in a tumble dryer.	
Outerwear		Max. load 2.5 kg*
Normal, Hand iron Δ		
Use for	Outerwear which is suitable for drying in a tumble dryer.	
Cottons hygiene		Max. load 3.5 kg*
Normal		
Use for	Cotton and linen fabric which is in direct contact with the skin, e.g. underwear, baby clothes, bed linen, towelling.	
Note	<p>The temperature is held constant for a longer period of time (longer temperature holding time) to deactivate micro-organisms, e.g. bacteria or house dustmites, and also to reduce the number of allergens in the laundry.</p> <p>To ensure that the micro-organisms are deactivated, do not interrupt the programme.</p>	
Proofing		Max. load 2 kg*
Normal		
Use for	Drying microfibre fabric, skiwear, fine, closeweave cotton garments (poplin) or tablecloths which are suitable for drying in a tumble dryer and have been treated to provide a water and dirt resistant finish.	
Notes	<ul style="list-style-type: none"> – This programme includes a proofing fixing phase. – Only use proofing agents containing fluorochemical compounds which are stated by the manufacturer as being "suitable for use on membrane textiles". – Do not dry items which have been treated with proofing agents containing paraffin. Fire hazard. 	

* Weight of dry laundry

Programme chart

Pillows		1-2 pillows up to 80 x 40 cm
Large pillows		1 pillow up to 80 x 80 cm
Normal		
Use for	Pillows suitable for drying in a tumble dryer, with feather, down or synthetic fillings.	
Note	Please observe the instructions on the care label. Pillows can still feel damp after being dried. You can use this programme several times until the pillow feels dry.	
Gentle smoothing		Max. load 1 kg*
Use for	<ul style="list-style-type: none"> – Cotton and linen fabric – Minimum iron mixed fibre, cotton or synthetic fabric, e.g. trousers, anoraks, shirts 	
Notes	<ul style="list-style-type: none"> – Suitable for dry and damp laundry. Dry garments are time-controlled, damp garments are smoothed to the Hand iron stage. – Smooths out creasing caused during the spin cycle in the washing machine. – Remove garments as soon as the programme has finished so that they are easy to iron. 	

* Weight of dry laundry

Programme chart

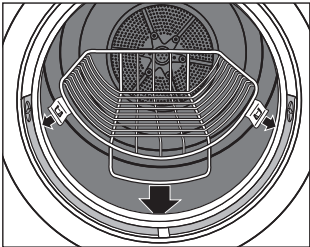
Cool air		Max. load 7 kg*
Use for	Any item which only needs airing.	
Warm air		Max. load 7 kg*
Use for	<ul style="list-style-type: none"> – Drying voluminous and multi-layered fabric whose layers have different drying characteristics, e.g. jackets, pillows. – For drying individual items, e.g. bath towels, swimwear, tea-towels. 	
Note	– Do not select the longest drying time to start with. Check the items as you are drying them to find the optimum time.	
Basket programme		Max. load for basket: 3 kg
Notes	<ul style="list-style-type: none"> – The drum does not rotate in this programme. For this reason, airing and drying may only be carried out if the Miele drying basket (optional accessory) is fitted in the drum. – Use this programme to dry items which are suitable for drying in a tumble dryer but which are not suitable for drying using mechanical action. – A satisfactory drying result cannot be achieved without the drying basket. – It is essential to observe the operating instructions for the drying basket. 	
Use for	See the operating instructions supplied with the drying basket.	

* Weight of dry laundry

Emptying the condensed water container

The condensed water will be collected in the condensed water container.

Empty the condensed water container after every drying programme.

If the maximum level of the condensed water container is reached

- the programme will be cancelled.
- *Empty the container* will appear in the display.

To delete the message:

- Switch the dryer off and then on again.

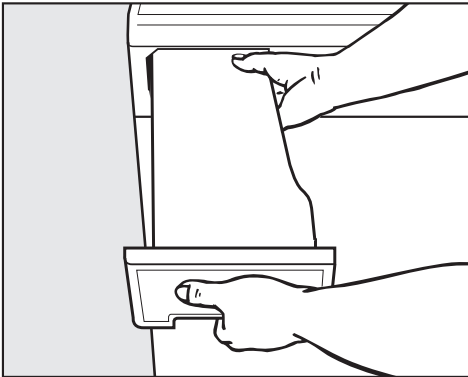

- Pull out the condensed water container.
- To prevent water running out, hold it at the front and towards the back and keep it in a horizontal position when carrying it.

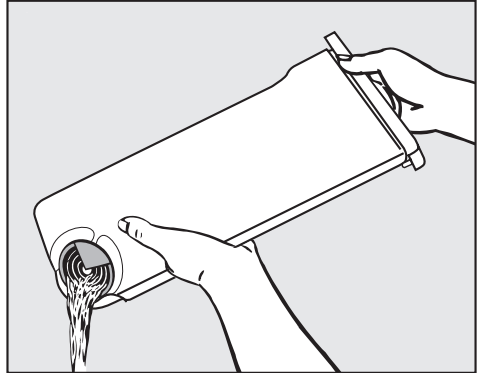

- Empty the container.
- Replace the container in the dryer.

 Condensed water should not be consumed. It could lead to health problems for people and animals.

Condensed water can be put to household use (e.g. in a steam iron or humidifier). To ensure that any residual particles of fluff in the condensed water are removed before use, pass it through a fine sieve or paper filter first.

Cleaning and care

Make sure you clean all the filters at the correct intervals

This tumble dryer has a multi-stage filter system, consisting of the **fluff filters** and a **fine filter**.

- **This dryer must not be used without the fluff filters or fine filter in place. The grille in the bottom right must always be in place.**
- **Make sure that the fluff filters and the fine filter are not damaged. Replace them immediately, if they are damaged in any way (optional accessories).**

 If the above instructions are not observed, an excessive build-up of fluff can occur which in turn can cause a fault.

When to clean the surfaces of the fluff filters

Clean the surfaces of the fluff filters after each drying programme.

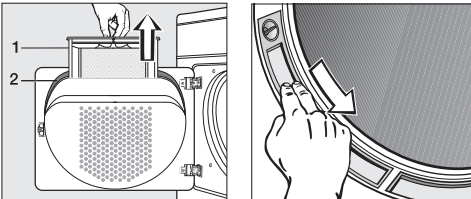

The fluff filters located in the door and the door opening collect fluff from items being dried.

- See "Cleaning the surfaces of the fluff filters".

When to clean the fine filter

Only clean the fine filter when *Clean the plinth filter* which is located in front of the heat-exchanger appears in the display.

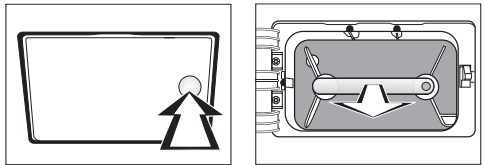

The plinth filter is located on the left of the dryer behind the panel. It collects finer fluff, hair and detergent residues which have got through the surfaces of the fluff filters in the door and the door opening.

- See "Fine filter".
- To delete the message: Touch the **OK** sensor.

Cleaning the surfaces of the fluff filters

When to clean

Clean the surfaces of the fluff filters in the door and the door opening after each drying programme.

Cleaning them whilst dry

Note: You can also use a vacuum cleaner to remove the fluff.

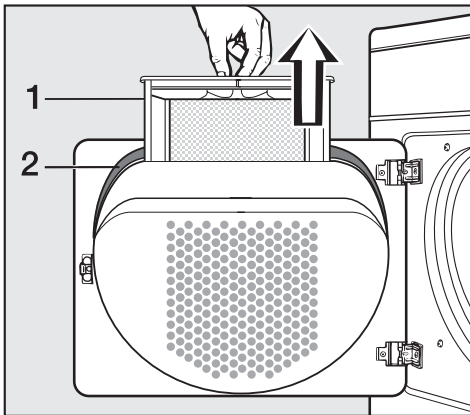

- 1 Fluff filter
- 2 Door seal

- Open the door and pull the fluff filter (1) out of the door as illustrated.
- Remove any fluff from the hollow part of the door with a bottle brush or a vacuum cleaner.
- Also clean the door seal (2) with a damp cloth.

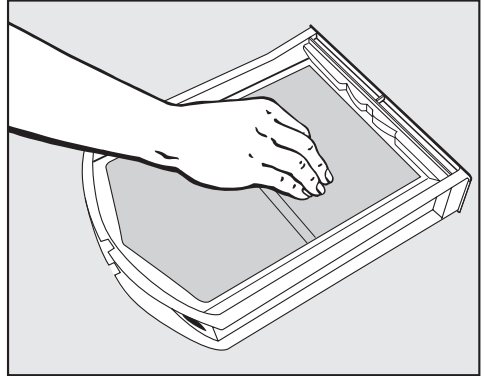

- Use your fingers or a vacuum cleaner to remove the fluff from the surface of

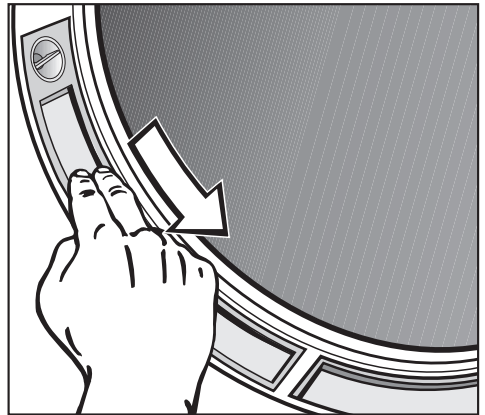

- the filter.
- Use your fingers or a vacuum cleaner to remove the fluff from the two fluff filters in the door opening.
- Once clean, push the filter back into the door holder until it clicks into position. Ensure it is facing the correct way.
- Close the door.

Cleaning and care

Cleaning with water

If there is a great deal of compacted fluff on any of the filters, they can be removed and cleaned under hot running water.

- Open the door and pull the fluff filter out of the door as described previously.

The two filters in the door opening can also be removed if you need to clean them with water.

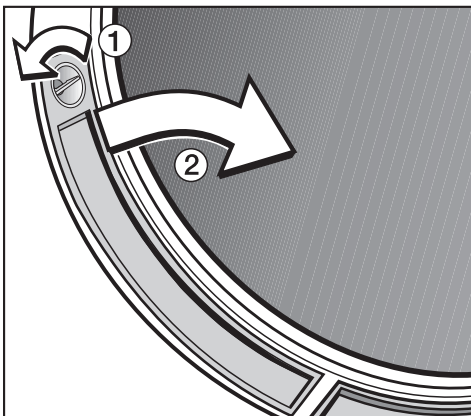

- Turn dial ① until you hear it click.
- Pull the filter by the dial out of the door opening as shown ②. Do the same on the other side.
- Rinse the filters under hot, running water.
- Dry the filters thoroughly with care.
- Also clean the airways underneath them, e.g. with a vacuum cleaner.

Replacing the filters

 Do not replace the filters if they are damp or wet. Damp or wet filters could cause operational faults.

- Push the large filter back into the door holder until it clicks into position. Ensure it is facing the correct way.
- Replace the filters in the door opening by first inserting them at the bottom and then pressing them into place at the top.
- Lock both dials (you will hear them click).

Fine filter

When to clean

Only clean the fine filter when *Clean the plinth filter* which is located in front of the heat-exchanger appears in the display.

- To delete the message: Touch the OK sensor.

Removing the fine filter

- Switch the dryer off.

On the front left of the tumble dryer:

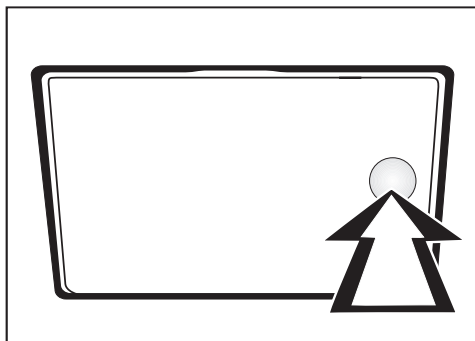

- Press to open the access panel for the fine filter (see arrow).

The panel will spring open.

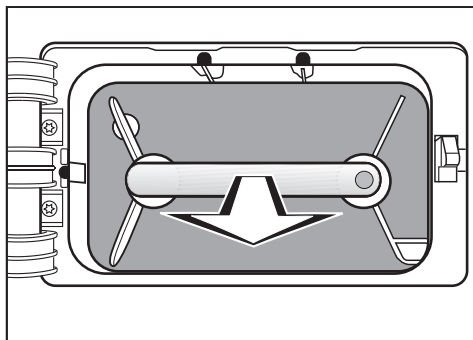

- Pull the filter out by the handle.

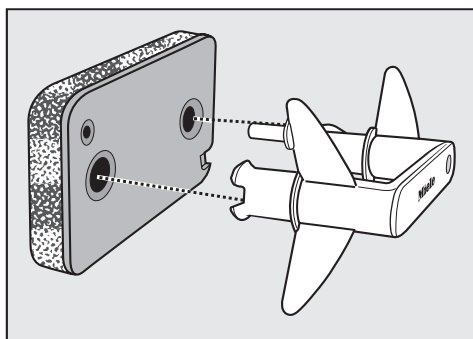

- Pull the handle out of the filter.

Cleaning the fine filter

- Clean the fine filter thoroughly under running water.
- Then squeeze it thoroughly.

 It must not be replaced dripping wet as this can cause a fault.

- Use a damp cloth to remove any fluff from the handle.

Cleaning and care

Cleaning the cover for the fine filter

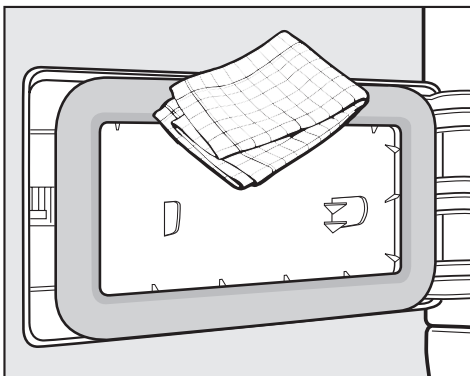

- Use a damp cloth to remove any fluff. Make sure that you do not damage the rubber seal when doing this.
- Check whether the cooling fins are blocked with fluff (as follows).

Cleaning the heat exchanger

 Danger of injury.
Do not touch the cooling fins. You could cut yourself.

 Prevent damage.
Carefully pass the vacuum cleaner brush over the surface, without applying any pressure. Otherwise the cooling fins or the struts in front of them could become damaged.

Visible soiling:

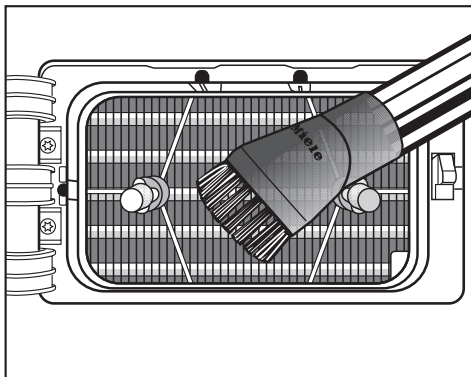

- Remove any visible soiling carefully with a vacuum cleaner using a dusting brush or a narrow crevice nozzle.

Replacing

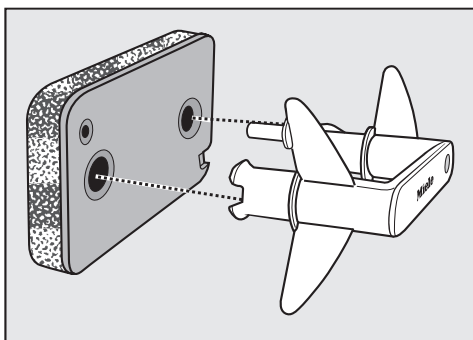

- Fit the filter back on the handle. Make sure it is the correct way round.

To ensure that the filter is positioned correctly in the front of the heat exchanger unit:

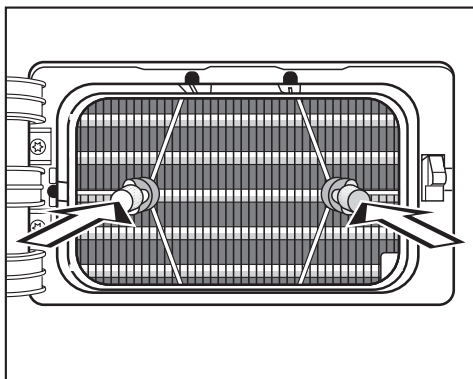

- First insert the handle with the filter attached over the two guide pins.

Make sure that the **yellow dot on the handle is on the right.**

- Push the filter in completely.
- Close the access flap.

The filter must be fitted correctly and the access flap closed to ensure that water cannot leak from the condenser system and to ensure that the dryer functions efficiently.

Cleaning the tumble dryer

Disconnect the dryer from the mains electricity supply.

- Clean the housing, control panel and door seal with a slightly damp cloth and a mild detergent or soapy water.
- The drum and other stainless steel parts can be cleaned with a suitable proprietary stainless steel cleaner following the manufacturer's instructions.

Do not use solvents, abrasive cleaners, glass cleaners or all-purpose cleaners. These could damage plastic surfaces and other parts.



- Dry all parts with a soft cloth.

Problem solving guide



With the help of the following notes minor faults in the performance of the appliance, some of which may result from incorrect operation, can be put right without contacting the Service Department.

 Repair work to electrical appliances should only be carried out by a suitably qualified person in strict accordance with current local and national safety regulations. Repairs and other work by unqualified persons could be dangerous. The manufacturer cannot be held liable for unauthorised work.

Check and fault messages in the display

Problem	Possible cause	Remedy
You are asked to enter a code.	Access via a code has been activated.	Enter the code (see <i>Settings</i> menu).
 Adjust the load The programme is cancelled, the buzzer sounds.	This is not a fault. The electronic unit has recognised that there is no laundry or insufficient laundry in the drum and cancelled the programme. Drying individual garments or items which are already dry can also cause the programme to be cancelled.	Use the <i>Warm air</i> programme for drying individual items. – Open and shut the door.
 Empty the container Empty the container or check the drain hose. The programme is cancelled, the buzzer sounds.	The condensed water container is full or there is a kink in the drain hose.	– Empty out the condensed water container or check the drain hose. To delete the message: – Switch the dryer off and then on again.

Problem solving guide

Problem	Possible cause	Remedy
 Clean the plinth filter which is located in front of the heat-exchanger appears at the end of a programme.	This is a reminder to clean the fine filter in front of the heat exchanger unit under running water.	<ul style="list-style-type: none"> – Clean the fine filter. See "Cleaning and care". To delete the message: <ul style="list-style-type: none"> – Touch the OK sensor.
 Fit plinth filter Fit the plinth filter appears and the programme cannot be started.	The fine filter is missing or has been replaced the wrong way round.	<ul style="list-style-type: none"> – Replace the fine filter correctly. – See "Cleaning and care". <ul style="list-style-type: none"> – Switch the dryer off and then on again.
	Removing the fine filter during a drying cycle will cause the programme to be cancelled.	
 Technical fault F1	A programme cannot be started while there is a fault message in the display.	<ul style="list-style-type: none"> – Make a note of what is shown in the display. – Switch the dryer off and then on again. – If a programme still cannot be started, Call Miele Service.
Comfort cooling	The programme has finished but the laundry is still being cooled down.	<ul style="list-style-type: none"> – You can either unload the drum and leave the laundry to cool at room temperature or leave it in the dryer to continue cooling.

Problem solving guide

Problem	Possible cause	Remedy *
 Clean out airways appears after a programme has been cancelled. The laundry is not properly dry.	The cool air intake panel is blocked.	<ul style="list-style-type: none"> – Move any objects, such as a laundry basket, away from the grille.
	The temperature in the room has risen sharply. To prevent the heat pump overheating, the dryer has cancelled the drying process with a cooling down phase.	<ul style="list-style-type: none"> – Open a door or window to keep the room temperature down. – Wait until the room has cooled down before restarting the programme.
	An excessive amount of fluff has built up.	<ul style="list-style-type: none"> – Check and clean the surfaces of the fluff filters and the fine filter. Use a vacuum cleaner dusting brush or small crevice nozzle to vacuum up any soiling carefully: <ul style="list-style-type: none"> – From the heat exchanger unit, bottom left (see "Cleaning and care").
A prompt which has not been described previously appears in the display.	A programme cannot be started while there is a fault message in the display.	<ul style="list-style-type: none"> – Follow the instructions in the display. – If a programme still cannot be started, call Miele Service.

*** To delete a fault message: Switch the dryer off and then on again.**

An unsatisfactory drying result		
Problem	Possible cause	Remedy
The laundry is not sufficiently dry.	The load consisted of different fabrics.	<ul style="list-style-type: none"> – Finish drying using the Warm air programme. – Select a different programme next time*.
Feather filled pillows smell after drying.	Feathers are a natural product and this is quite normal.	The smell will dissipate after sufficient airing.
Items made of synthetic fibres are charged with static electricity after drying.	Synthetic fibres tend to attract static charge.	Static charge can be reduced by adding a fabric conditioner to the final rinse in the washing programme or a fabric conditioner sheet to the load when drying.
There is a build-up of fluff.	Fluff is principally the result of friction when garments are being worn and to some extent when they are being washed. Machine drying hardly causes any fluff to form and has no appreciable effect on the lifetime of the fabric.	Fluff is collected by the fluff filters and can be removed easily (see "Cleaning and care").

* You can alter the drying levels for some programmes (see "Settings menu").

Problem solving guide

Other problems		
Problem	Possible cause	Remedy *
The drying process goes on too long or even switches off.	Ventilation to and from the dryer may be insufficient, e.g. because it is installed in a room which is too small. This can cause the temperature in the room to rise sharply.	Open a door or window while the dryer is in operation for increased air flow.
	<ul style="list-style-type: none"> – Detergent residues, hair and fine fluff can clog the fluff filters and the fine filters. – The cooling ribs can be clogged. 	<ul style="list-style-type: none"> – Clean the fluff filters and fine filter. – Remove any visible fluff: <ul style="list-style-type: none"> . . . From the heat exchanger unit, bottom left, behind the flap in the heat exchanger cavity (see "Cleaning and care"). . . . From the cooling fins behind the grille, bottom right (see this section).
	The cool air intake (bottom right grille) is blocked.	Move any objects, such as a laundry basket, away from the grille.
	The fluff filters and fine filter were wet when replaced.	The fluff filters and fine filter must be dry.
	The laundry has not been spun sufficiently.	Make sure that your laundry is thoroughly spun at the appropriate spin speed in the washing machine.
	The tumble dryer has been overloaded.	Do not exceed the maximum load for the programme selected.
	Metallic components, e.g. zips have prevented the dryer from registering the correct moisture level in the laundry.	<ul style="list-style-type: none"> – Open zips next time. – If the problem occurs again, dry garments with long zips using the <i>Warm air</i> programme (timed drying).

*** Switch the dryer off and then on again before starting the programme.**

Problem solving guide

Problem	Possible cause	Remedy
There are humming noises.	The compressor is operating.	These noises are quite normal and do not indicate a fault.
The display and the sensors are not lit up and the <i>Start</i> sensor is flashing slowly.	The display and sensor illumination switch off to save energy.	<ul style="list-style-type: none"> – Touch the <i>Start</i> sensor. The display and sensors will light up. – See "Settings menu, Display / keypad illumination".
The programme does not start.	No obvious cause.	<ul style="list-style-type: none"> – Is the dryer switched on? – Is the plug correctly inserted into the socket and switched on? – Is the door closed properly? – Has the fuse or circuit breaker tripped? – If you cannot remedy the problem, then there could be a fault. Contact Miele Service.
Power cut.	When power is restored, any programme which was running will restart automatically.	
The display is in a different language.	A different language has been selected.	Set the language you want. The flag symbol  will guide you.
The interior drum lighting does not come on.	The lighting switches off automatically (to save energy).	<ul style="list-style-type: none"> – Switch the dryer off and then on again. – If the lamp needs to be replaced, follow the instructions in "Changing the lamp" at the end of this section.
	Access via a code has been activated.	– When the code is entered the lighting will come back on.

Problem solving guide

Cleaning the cooling fins (bottom right grille)

⚠ In general, the cooling fins do not need cleaning. They should only be cleaned if the drying process is taking an exceptionally long time due to a very high level of dust or fluff in the room in which the dryer is installed.

Use the yellow lever supplied to open the bottom right grille.

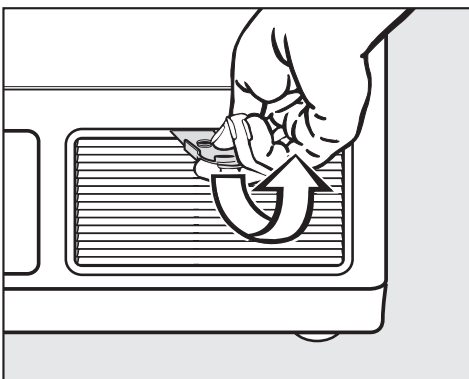

- Insert the lever in the middle of the gap at the top and lift it up gently (see arrow) until the grille opens out at the top.
- Now remove the grille by pulling it diagonally upwards.
- Check whether the cooling fins are clogged.

⚠ Danger of injury.
Do not touch the cooling fins with your hand. You could cut yourself.

⚠ To prevent damaging the cooling fins, only pass the vacuum cleaner brush over them lightly, without applying any pressure.

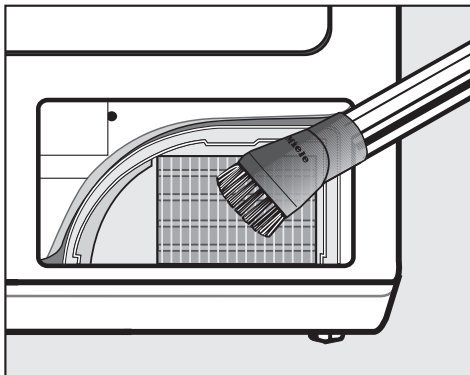

- Vacuum up any soiling **carefully** using a vacuum cleaner dusting brush or small crevice nozzle.

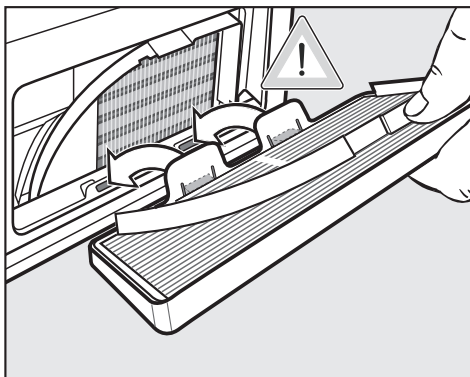

- To replace the grille, first insert the bottom of the grille (as shown).
- Then push the grille firmly into position at the top.

Changing the lamp

Disconnect the tumble dryer from the mains electricity supply.

- Open the door.

You will find the interior light cover at the top of the drum aperture.

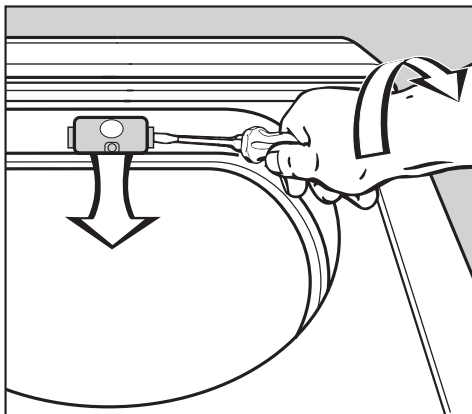

- Insert a suitable tool, such as a wide bladed screwdriver, under the side edge of the light cover as illustrated.
- Apply a little pressure and whilst doing so turn your wrist in the direction of the arrow to open the cover.

The cover will open downwards.

The temperature resistant lamp should only be ordered from your Miele Dealer or the Miele Spare Parts Department.

The light specification and maximum wattage is stated on the data plate and on the light cover.

- Turn the light anti-clockwise to remove.
- Replace the lamp.
- To close the cover push it upwards and press it on the left and right until you hear it click into position.

 Ensure that it is fitted into position securely, as any moisture could cause a short circuit.

After Sales service

Repairs

In the event of any faults which you cannot remedy yourself, please contact

- your Miele dealer or
- the Miele Service Department (see back cover for contact details).

When contacting your dealer or the Service Department, please quote the model and serial number of your appliance, both of which are shown on the data plate. This is visible when you open the door.

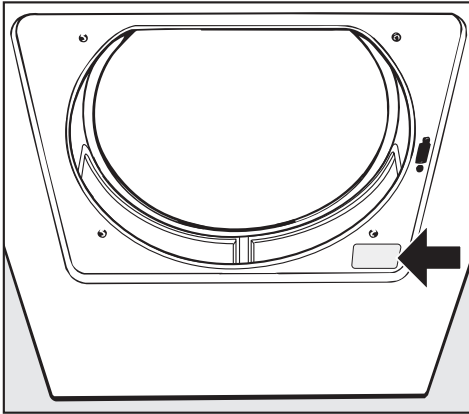

N.B. A call-out charge will be applied for service visits where the problem could have been resolved as described in these instructions.

Future updates (PC)

The indicator or check light marked **PC** on the fascia panel is the interface used by the Miele service technicians during service work for testing purposes and for updating the appliance's programme data.

Appliance guarantee

In the U.K. your appliance is guaranteed for 2 years from the date of purchase. However you must activate your cover by calling 0845 365 6640 or registering online at www.miele.co.uk.

For information on the appliance guarantee specific to your country please contact Miele. See back cover for contact details.

Optional accessories

Optional accessories for this dryer are available from your Miele Dealer, the Miele Spare Parts Department or via the internet at www.miele-shop.com.

Please note that telephone calls may be monitored and recorded for training purposes.

Front view

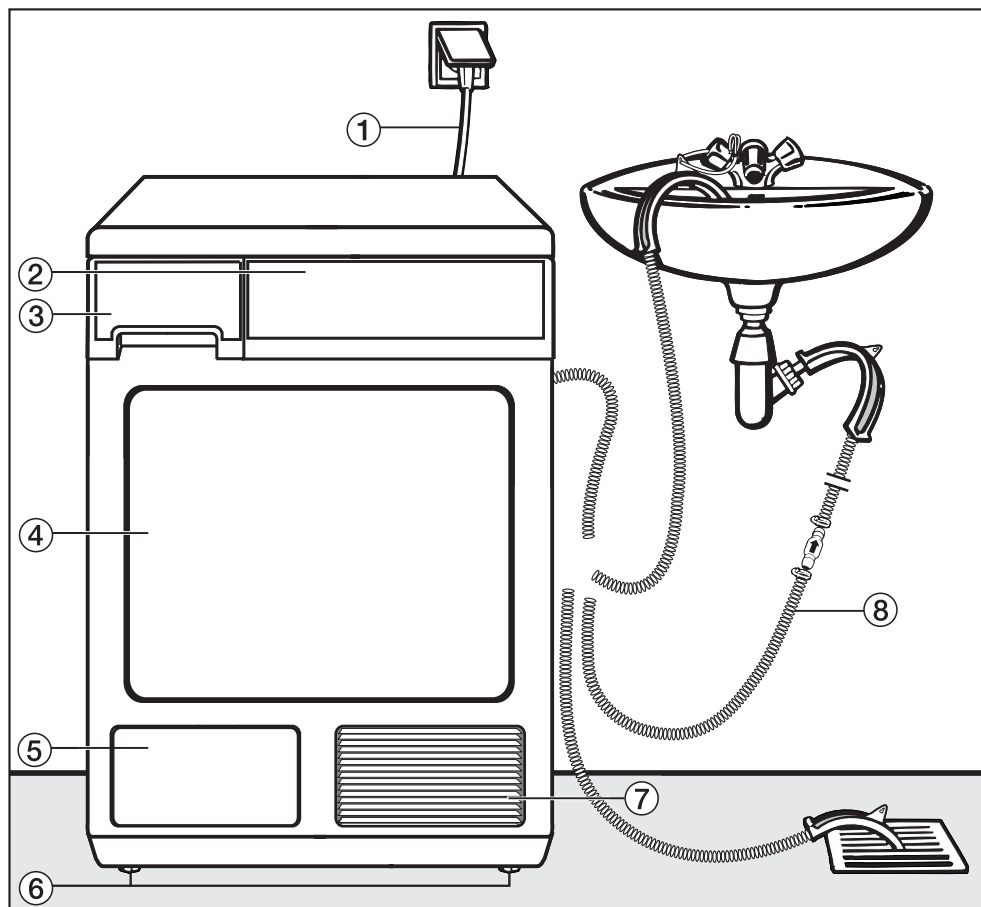

- ① Mains connection cable
- ② Control panel
- ③ Condensed water container (empty after every drying programme)
- ④ Door
- ⑤ Service panel for the fine filter (do not open during drying)
- ⑥ Four height adjustable screw feet
- ⑦ Cool air intake grille (do not obstruct with a laundry basket or other objects)
- ⑧ External drainage of condensed water hose (see "External condensed water outlet")

Installation and connection

Rear view

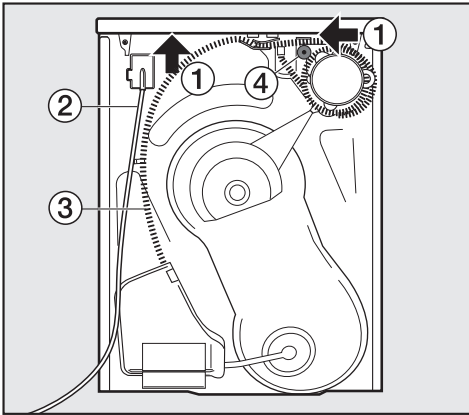

- ① Protruding lid for holding when moving the dryer (see arrows)
- ② Mains connection cable
- ③ Hose for external drainage of condensed water
- ④ Accessories for connection to a sink drain outlet

Transporting the dryer

When moving the dryer, hold it by the lid where it protrudes to the rear. To manoeuvre the dryer out of its packing case to its installation site you will also need to hold it by the front feet.

 Only transport the dryer as shown in the following illustrations.

 If transporting the dryer at an angle, only tip it towards its left side.

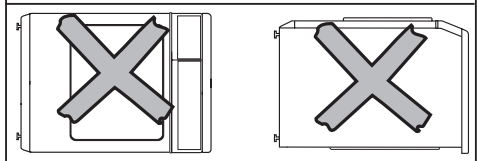
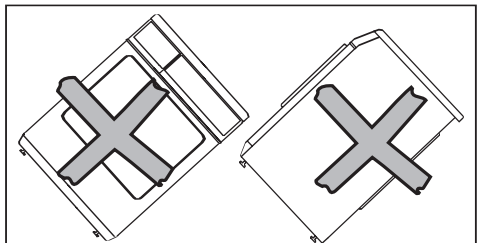
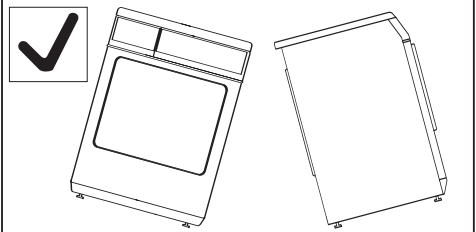
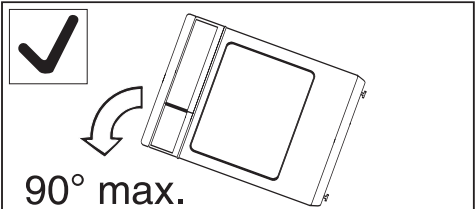

 If the tumble dryer has not been transported as described, then it must be left to stand for at least 1 hour before it is connected to the electricity supply. Otherwise the heat pump can be damaged.

Installation site

 Make sure the dryer door can be opened without hindrance after installation.

 The cool air intake panel at the front of the dryer must not be blocked or covered, e.g. by a laundry basket, as this would cause a fault.

Building under a continuous worktop/ in a row of kitchen units

 It is very important to avoid a build-up of heat. The warm air which is expelled from the rear of the dryer must be able to dissipate. Warm air which cannot dissipate could cause a fault.

A build-up of heat can be avoided by:

- Adjusting the screw feet so that there is a gap of at least 20 mm between the floor and the bottom of the dryer.
- Creating a gap for the dryer in the kitchen furniture plinth facing.
- Creating ventilation gaps in the kitchen unit.

N.B. When built under, drying times may be longer.

 The dryer should not be installed next to a refrigeration appliance. The warm air expelled from the rear of the dryer would increase the temperature around the refrigeration appliance's heat exchanger causing the compressor to run continuously. If it is not possible to install the dryer anywhere else, then the refrigeration appliance must be sealed off from the dryer.

 A **building-under kit** (Miele accessory, available to order) with a coverplate to replace the appliance's lid is required. It must be fitted by a suitably qualified person to ensure electrical safety.

N.B. If you wish to push the tumble dryer under a worktop and there is space to do this **without removing the lid** the building-under kit is not necessary. Otherwise the building-under kit is essential.

- The building-under kit is supplied with its own installation instructions.
- N.B. When built under, drying times may be longer.
- The electrical socket must be located in an accessible position near the appliance.

With niche heights of:

- 830-840 mm, longer screw feet* are required.
- 870-885 / 915-930 mm, one or two raising kits* are required.

* Miele accessory available to order

Installation and connection

Levelling the appliance

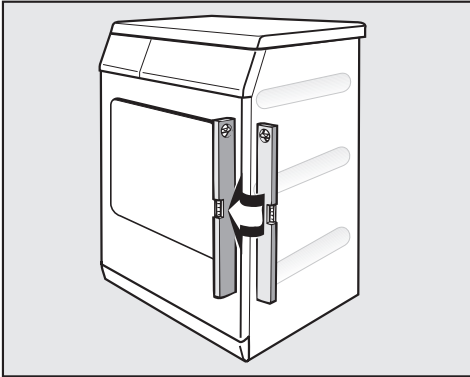

The appliance must be perfectly level to ensure safe and proper operation.

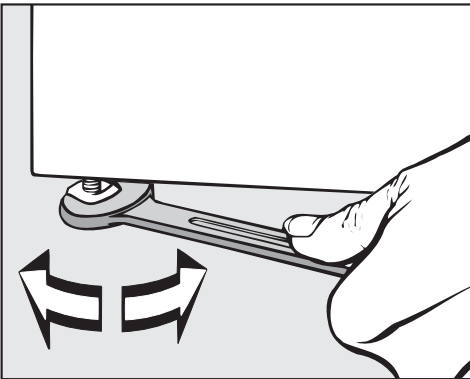

- The screw feet can be adjusted to compensate for any unevenness in the floor.

 Do not block the gap between the bottom of the tumble dryer and the floor with plinth facings, deep pile carpet etc. This would hinder a sufficient flow of air to the dryer.

Before moving the tumble dryer again (e.g. when moving house)

After each use a small quantity of condensed water will collect in the area around the pump. This water can run out if the tumble dryer is tipped up when it is being moved. It is a good idea to run the *Cool air* programme for approximately 1 minute before moving it. Any remaining condensed water will then be fed into the condensed water container or out through the drain hose.

Washer-dryer stack

The tumble dryer can also be combined with a Miele washing machine in a washer-dryer stack. The appropriate "WTV" stacking kit* to match your dryer is required.

* Miele accessory available to order

 Stacking kits must only be installed by a suitably qualified fitter.

External condensed water outlet

General notes

When drying is in progress, condensed water is pumped into the condensed water container through the drain hose at the back of the dryer. The condensed water can also be drained off directly if the tumble dryer is installed near a sink, drain outlet etc. so that the condensed water container does not have to be emptied.

Drain hose length 1.50 m
Maximum delivery head 1.50 m
Maximum drain hose length 4.00 m

 If the on-site water drainage system is not fitted with a non-return valve or an appropriate air gap, one must be fitted to prevent the risk of back-flow. (See "Installation conditions requiring a non-return valve").

The following optional accessories are available:

- an extension hose
- a non-return valve kit for connection to an external condensed water outlet (includes an extension hose). Maximum delivery head with non-return valve fitted: 1.00 m

Arranging the drain hose

 Do not pull on the drain hose and do not stretch it or allow it to become kinked as it could get damaged.

- There will be a small amount of residual water in the drain hose. Have a container ready to collect this.

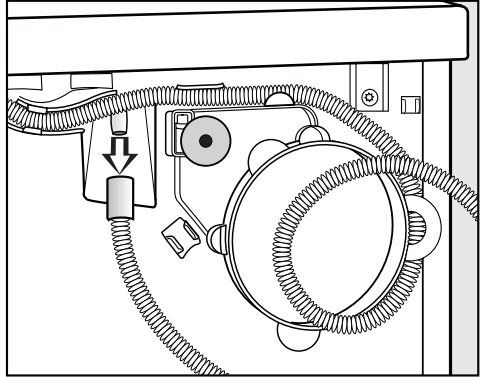

- Pull the hose off its connection (see arrow).
- Allow any residual water to run into the container.
- Unwind the hose and pull it carefully out of the holders.

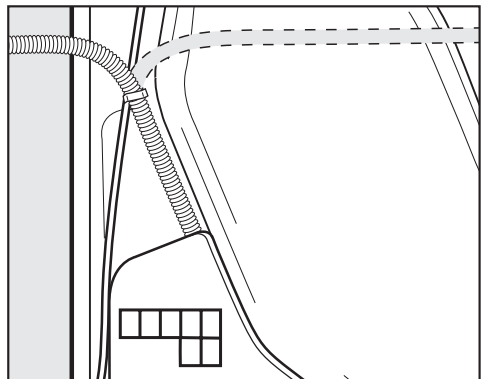

- Position the hose to the right or left hand side as necessary.

Leave the hose in the middle holder to prevent it from becoming kinked inadvertently.

Installation and connection

External drainage via a sink or gully

- See "Front view" illustration.

 If you want to drain the water off into a sink you will need to secure the hose carefully, e.g. by tying it to a tap to make sure it cannot slip during use. Otherwise there is a risk of overflowing water which could cause damage.

- Use the bow-shaped guide to prevent the drain hose from becoming kinked.

Installation conditions requiring a non-return valve

 Certain installation conditions require the fitting of a **non-return valve for external water connection** (available as an optional accessory). A non-return valve will prevent the risk of back-flow out of the dryer which could cause damage.

A non-return valve is required:

- If the tumble dryer is connected to a sink drain outlet (see the following section).
- If the tumble dryer is connected to a drainage system **already in use** by another appliance, e.g. a dishwasher or washing machine.

Example: Connection to a sink drain outlet

The drain hose with non-return valve fitted can be connected directly to a suitable sink drain outlet.

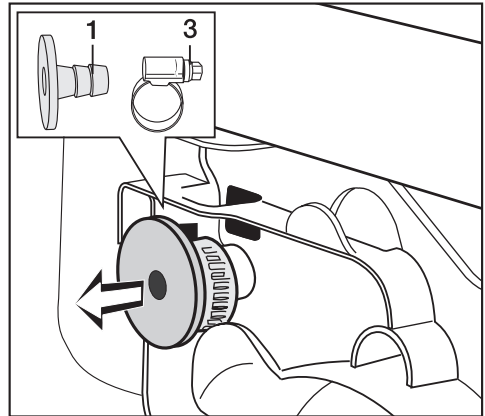

- Remove the following from the back of the dryer at the top:
Adapter **1** and hose clip **3** behind it.

Installation and connection

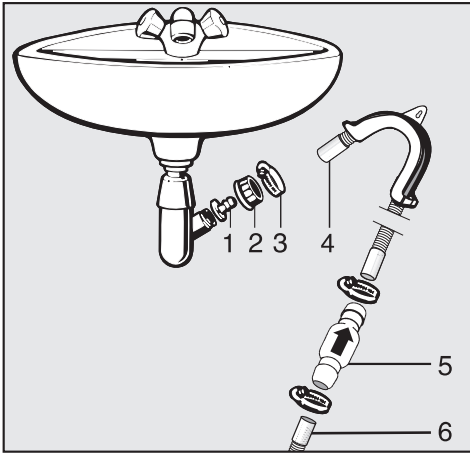

- 1 Adapter
- 2 Nut
- 3 Hose clip
- 4 End of the hose
- 5 Non-return valve
- 6 Tumble dryer drain hose

- Fit adapter **1** to the sink drain outlet using nut **2**.

If this nut has a flat disc in it you should take the disc out first.

- Attach the end of hose **4** to adapter **1**.
- Use a screwdriver to tighten hose clip **3** up close to the nut.

 Non-return valve **5** has to be fitted with the arrow pointing in the direction of flow (i.e. towards the sink). Otherwise water will not drain out of the appliance.

- Fit non-return valve **5** to tumble dryer drain hose **6** (make sure it is fitted in the correct direction - see arrow on non-return valve).
- Secure the non-return valve using hose clips.

Electrical connection

Electrical connection U.K.

All electrical work should be carried out by a suitably qualified and competent person, in strict accordance with current national and local safety regulations (BS 7671 in the UK).

Ensure power is not supplied to the appliance until after installation work has been carried out.

The appliance is supplied with a mains cable with moulded plug ready for connection to a 230-240V mains supply. Please ensure the connection data quoted on the data plate match the household mains supply.

Connection should be made via a suitable switched socket which is easily accessible after installation.

For extra safety it is advisable to protect the appliance with a suitable residual current device (RCD). Contact a qualified electrician for advice.

Do not connect via an extension lead. Extension leads do not guarantee the required safety of the appliance (e.g. danger of overheating).

Non-rewireable plugs BS 1363

The fuse cover must be refitted when changing the fuse, and if the fuse cover is lost, the plug must not be used until a suitable replacement is obtained. The colour of the correct replacement cover is that of the coloured insert in the base of the plug, or the colour that is embossed in words on the base of the plug (as applicable to the design of plug fitted).

Replacement fuses should be ASTA approved to BS 1362 and have the correct rating. Replacement fuses and fuse covers may be purchased from your local electrical supplier.

**WARNING: THIS APPLIANCE
MUST BE EARTHED**

Consumption data

	Load ¹	Final spin speed in a domestic washing machine	Residual moisture	Energy	Duration
	kg	rpm	%	kWh	min.
Cottons Normal ²	8.0	1000	60	2.02	154
	4.0	1000	60	1.11	89
Cottons Normal	8.0	1200	53	1.80	139
	8.0	1400	50	1.70	132
	8.0	1600	44	1.55	118
	8.0	1800	43	1.50	116
Cottons Normal + Gentle tumble + Freshen up	8.0	1000	60	2.05	153
	3.0	1000	60	0.95	75
Cottons Hand iron ∆∆	8.0	1000	60	1.40	111
	8.0	1200	53	1.20	97
	8.0	1400	50	1.15	91
	8.0	1600	44	0.95	77
	8.0	1800	43	0.95	75
Minimum iron Normal	3.5	1200	40	0.60	51
Minimum iron Normal + Gentle tumble + Freshen up	3.5	1200	40	0.60	53
	3.5	1200	40	0.65	52
Minimum iron Hand iron	3.5	1200	40	0.50	45
Automatic plus Normal	5.0	800	50	1.35	109
Shirts Normal + Gentle tumble	2.0	600	60	0.70	57
	2.0	600	60	0.75	60
Hygiene Normal	3.5	1000	60	1.70	140
Gentle smoothing	1.0	1000	60	0.30	30
Proofing Normal	2.0	800	50	1.20	99
Outerwear Normal	2.5	800	50	0.95	80
Denim Normal + Gentle tumble	3.0	900	60	1.30	107
	3.0	900	60	1.40	115
Express Normal	3.5	1000	60	1.00	82
Woolens	2.0	1000	50	0.15	20

¹ Weight of dry laundry

² Test programme in accordance with Regulation 392/2012/EU for energy labelling measured in accordance with EN 61121.

All data was calculated using EN 61121 unless otherwise stated.

Notes for test institutes:

- When selecting the *Cottons* programme, drain the condensed water away through the drainage hose.
- Before testing in accordance with EN 61121, dry a 3 kg load of cotton laundry with 70% residual moisture as per the above standard using the Cottons Normal programme without any extra options.

Consumption data can vary from the nominal values given above depending on the size of the load, types of textiles, residual moisture levels after spinning, fluctuations in the electricity supply and any extra options selected.

Technical data

Height	850 mm
Width	595 mm
Depth	596 mm
Depth with door open	1071 mm
Height for building under	820 mm
Width for building under	600 mm
Depth for building under	600 mm
Suitable for pushing under a worktop	yes
Suitable for stacking	yes
Weight	61 kg
Drum volume	111 litres
Maximum capacity	1-8 kg dry weight
Capacity of condensed water container	Approx. 4.2 litres
Drain hose length	1.5 m
Maximum delivery head	1.5 m
Maximum drain hose length	4 m
Length of connection cable	2 m
Voltage	See data plate
Connected load	
Fuse rating	
Lamp wattage	
Test certificates awarded	
Energy consumption	see "Consumption data"

The Settings menu is used to alter the dryer's electronics to suit different requirements. Settings can be altered at any time.

Open the Settings menu



- Use the top right hand sensor to select the *Settings* menu.
- Confirm with **OK**.

To select a setting



- The sensors on the right can be used to scroll up or down the list.

Language

The display can be set to appear in one of several different languages.

To select the language you want, go to the *Language* sub-menu.

The flag after the word *Language* acts as a guide to prevent a language which will not be understood from being set.

Settings menu

Time

The time can be set to appear as a 24 hour or 12 hour clock. You can also use this setting to adjust the time of day.

Clock format



- Select the format you want.

The dryer is delivered with the clock format set as a 24 hour clock.

Set the time of day

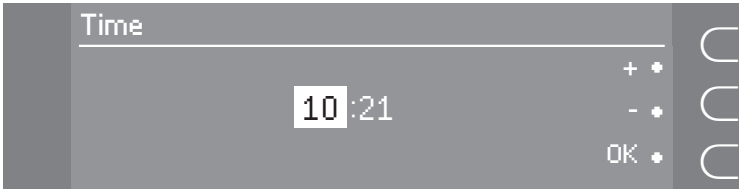

- Use the + and - sensors to set the hour.
- Confirm the hours with **OK** and then enter the minutes.

Drying levels

You can alter the drying levels for the *Cottons*, *Minimum iron* and *Automatic plus* programmes.

The bars show you the setting.
The default is: the middle setting.

- Drier ■■■■■■
the programme duration increases.
- Damper ■
the programme duration is shorter.

Code

The code prevents the dryer being used without your knowledge.

When the code has been activated, you have to enter a code after switching the dryer on. Otherwise the dryer cannot be operated.

The door can be opened and items removed at any time.

To activate the code

The display will now request that a code is entered. The code is **250** and cannot be altered.

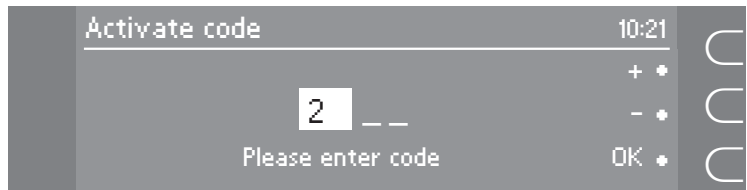

- Use **+** to enter the first number.
- Confirm the first number with **OK** and then enter the second number. Repeat the process until all three numbers have been entered.
- After the last number has been entered, you must confirm the code with **OK**.

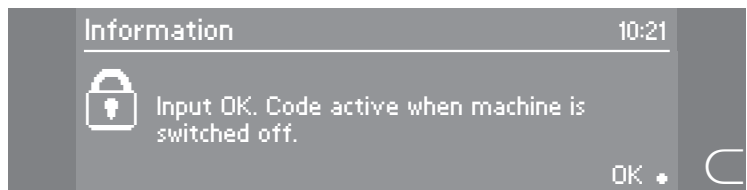

- Confirm with **OK**.
- Switch the dryer off.

Settings menu

To use the dryer when the lock code is activated

When the dryer is switched on again, the display will request the code.

- Enter code **250** with the **+** and **-** sensors.

The dryer is now unlocked and ready for use.

To deactivate the code

- Proceed as for activating the code.

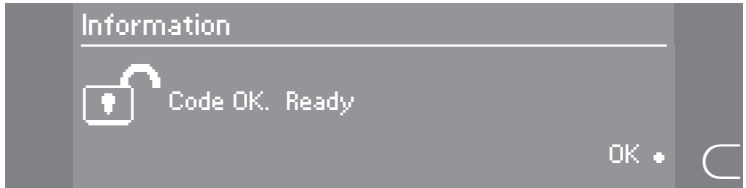

- Confirm with **OK**.

You can now switch on the dryer without being asked to enter a code.

Buzzer

When the buzzer function has been activated, an audible tone sounds at the end of a programme.

Off

Factory default

The buzzer is switched off but sounds at maximum volume if there is a fault.

Normal

The buzzer sounds at the end of a programme.

Loud

The buzzer sounds louder at the end of a programme.

Keypad tone

An audible tone sounds each time a button is pressed.

Off

Factory default

On

Brightness

Contrast

The display contrast and brightness can be altered in stages.

The bars ■■■■■■■■ show you which level is set.

If you make an alteration it will appear in the display immediately.

Display / keypad illumination

The display and sensor illumination switches off to save energy. *Start* flashes slowly to save energy.

The display and the sensors are not illuminated.

- if a programme is not selected within 10 minutes of the tumble dryer being switched on.
- 10 minutes after the end of a programme.

Press the *Start* sensor to activate the display and sensor illumination again.

Off after 10 minutes

The display and sensor illumination will switch off 10 minutes after the programme has started.

"On" whilst programme is running

Factory default

The display and sensors remain lit up whilst the programme is running.

Settings menu

Memory

The electronics will memorise the drying level and some of the extra options selected for the current drying programme and the duration of a timed drying programme.

When the programme is chosen again these settings will appear in the display.

Off

Factory default

On

Anti-crease

Anti-crease helps prevent creasing, if laundry is not normally removed immediately after the end of a programme.

After the programme has finished, the drum will continue to rotate at intervals.

There is no anti-crease phase with *Wollens*.

Off

1 hour

2 hours

(Factory default)

Optional accessories for this dryer are available from your Miele Dealer or from the Miele Spare Parts Department,



or via the internet at www.miele-shop.com.

Fragrance flacon

For a pleasant fragrance when drying your laundry.

Holder for fragrance flacon

The holder is required to fit the fragrance flacon to the fluff filter.

The holder comes with its own instructions.

Dryer basket

This enables items which must not be subjected to mechanical action to be dried or aired.

The dryer basket comes with its own instructions.

United Kingdom

Miele Co. Ltd.
Fairacres, Marcham Road
Abingdon, Oxon, OX14 1TW
Tel: 0845 365 0555, Fax: 0845 365 0777
Customer Contact Centre Tel: 0845 365 6600
E-mail: info@miele.co.uk
Internet: www.miele.co.uk

Australia

Miele Australia Pty. Ltd.
ABN 96 005 635 398
1 Gilbert Park Drive, Knoxfield, VIC 3180
Tel: 1300 464 353, Fax: (03) 9764 7149
Internet: www.miele.com.au

China

Miele (Shanghai) Trading Ltd.
1-3 Floor, No. 82 Shi Men Yi Road
Jing' an District
200040 Shanghai, PRC
Tel: +86 21 6157 3500, Fax: +86 21 6157 3511
E-mail: mieleshanghai@cn.miele.com
Internet: www.miele.cn

Miele (Hong Kong) Limited

41/F - 4101, Manhattan Place
23 Wang Tai Road
Kowloon Bay
Hong Kong
Tel: (852) 2610 1331, Fax: (852) 2610 1013
Email: mielehk@miele.com.hk

India

Miele India Pvt. Ltd.
Ground Floor, Copia Corporate Suites
Plot No. 9, Jasola
New Delhi - 110025
Tel: 011-46 900 000, Fax: 011-46 900 001
E-mail: customercare@miele.in, Internet: www.miele.in

Ireland

Miele Ireland Ltd.
2024 Bianconi Avenue
Citywest Business Campus, Dublin 24
Tel: (01) 461 07 10, Fax: (01) 461 07 97
E-Mail: info@miele.ie, Internet: www.miele.ie

Manufacturer: Miele & Cie. KG

Carl-Miele-Straße 29, 33332 Gütersloh, Germany

Miele

Malaysia

Miele Sdn Bhd
Suite 12-2, Level 12
Menara SapuraKencana Petroleum
Solaris Dutamas No. 1, Jalan Dutamas 1
50480 Kuala Lumpur, Malaysia
Phone: +603-6209-0288
Fax: +603-6205-3768

New Zealand

Miele New Zealand Limited
Unit L, 10-20 Sylvia Park Road
Mt. Wellington, 1060, Auckland, NZ
Tel: 0800 264 353, Fax: 0800 463 453
Internet: www.miele.co.nz

Singapore

Miele Southeast Asia
Miele Pte. Ltd.
163 Penang Road
04 - 02/03 Winsland House II
Singapore 238463
Tel: +65 6735 1191, Fax: +65 6735 1161
E-Mail: infosea@miele.com.sg
Internet: www.miele.sg

South Africa

Miele (Pty) Ltd
63 Peter Place, Bryanston 2194
P.O. Box 69434, Bryanston 2021
Tel: (011) 875 9000, Fax: (011) 875 9035
E-mail: info@miele.co.za
Internet: www.miele.co.za

United Arab Emirates

Miele Appliances Ltd.
P.O. Box 11 47 82
Gold & Diamond Park
Sheikh Zayed Road
Building 6 / Offices Nos. 6-214 to 6-220
Dubai
Tel: +971-4-341 84 44
Fax: +971-4-341 88 52
E-Mail: info@miele.ae, Internet: www.miele.ae

Free Manuals Download Website

<http://myh66.com>

<http://usermanuals.us>

<http://www.somanuals.com>

<http://www.4manuals.cc>

<http://www.manual-lib.com>

<http://www.404manual.com>

<http://www.luxmanual.com>

<http://aubethermostatmanual.com>

Golf course search by state

<http://golfingnear.com>

Email search by domain

<http://emailbydomain.com>

Auto manuals search

<http://auto.somanuals.com>

TV manuals search

<http://tv.somanuals.com>