

Operating instructions

Freestanding coffee machine



To avoid the risk of accidents or damage to the machine, it is **essential** to read these instructions before it is installed and used for the first time.

Packaging material / Disposal of old machine

Packaging material

The packaging material used protects the machine during transportation.

Please retain the original box and polystyrene pieces so that you can pack the machine securely, should you need to transport it in the future.

The original packaging should also be kept in case the machine ever needs to be returned to Miele for servicing.

Disposing of your old machine

Electrical and electronic appliances often contain valuable materials. They also contain materials which, if handled or disposed of incorrectly, could be potentially hazardous to human health and to the environment. They are, however, essential for the correct functioning of your appliance. Please do not therefore dispose of it with your household waste.

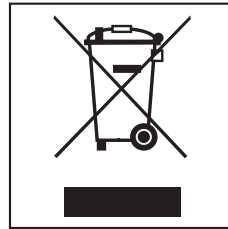

Please dispose of it at your local community waste collection / recycling centre.

Ensure that it presents no danger to children while being stored for disposal.

Packaging material / Disposal of old machine	2
Warning and Safety instructions	6
Guide to the machine	13
Controls and display	14
Accessories	15
Before using for the first time	16
Before using for the first time	16
Switching on for the first time	16
Water hardness	17
Operation	18
Filling the water container	19
Filling the coffee bean container	20
Switching on and off	21
Pre-heating cups (cup heating)	22
Adjusting the central spout to the correct cup height	23
Making drinks	24
Espresso or coffee	24
To make two portions	24
Cancelling preparation	25
Making coffee with ground coffee	25
Adding ready ground coffee	26
Making coffee with ready ground coffee	26
Drinks with milk	27
Preparing hot water	29
Making drinks using a profile	29
Coffee the way you like it	30
Grinder setting	30
Displaying and changing the parameters of a drink	31
Amount of coffee	31
Brew temperature	31
Pre-brewing	32
Portion size	33
Changing portion size while making a drink	33
Changing portion sizes in the "Parameters" menu <i>⓪</i>	35
Changing the portion size for different profiles	35

Contents

Profiles	36
Calling up a profile	36
Creating a profile	36
Select profile	37
Change name	37
Delete profile	37
Changing a profile	38
Settings	39
Calling up the "Settings" menu	39
Changing and saving settings	39
Overview of available settings	40
Language	41
Time	41
Timer	41
Eco mode	42
Lighting	42
Info (display information)	43
Locking the coffee machine (System lock )	43
Water hardness	43
Display brightness	43
Volume	43
Cup heating	43
Factory default	44
Showroom programme (Demo mode)	44
Cleaning and care	45
Quick guide	45
Rinsing the machine	46
Milk pipework	47
Central spout with cappuccinatore	49
Milk flask	50
Clean the water container	51
Drip tray cover	51
Drip tray and waste container	52
Bean container and ground coffee chute	53
Brew unit	53
Removing and cleaning the brew unit by hand	53
Degreasing the brew unit	55
Housing	56

Descaling	57
Problem solving guide	59
Transporting the machine	69
Evaporating the coffee machine	69
Packing the machine	69
After Sales / Guarantee	70
Saving energy	71
Electrical connection	72
Installation	73
Appliance dimensions	74
Technical data	75
Addresses	79

Warning and Safety instructions

This coffee machine complies with current safety requirements. Improper use can, however, present a risk of both personal injury and material damage.

To avoid the risk of accidents and damage to the machine, please read these instructions carefully before using it for the first time. They contain important notes on setting it up, as well as on its safety, operation and maintenance.

Miele cannot be held liable for damage caused by non-compliance with these Warning and Safety instructions.

Keep the instructions in a safe place and pass them along to any future owner.

Correct application

- ▶ This coffee machine is intended for use in domestic households and similar working and residential environments.
- ▶ This coffee machine is not intended for outdoor use.
- ▶ The machine is only intended for making domestic quantities of coffee based drinks such as espresso, cappuccino, latte macchiato etc.
Any other usage is at the owner's risk.
- ▶ This coffee machine can only be used by people with reduced physical, sensory or mental capabilities, or lack of experience and knowledge, if they are supervised whilst using it, or have been shown how to use it in a safe way and recognise and understand the consequences of incorrect operation.

Safety with children

 There is a danger of burning and scalding from the coffee and hot water dispensing spouts. Children's skin is far more sensitive to high temperatures than that of adults. Ensure children do not touch hot surfaces of the coffee machine or place parts of their body under the dispensing spouts.

- ▶ Place the coffee machine where it is out of the reach of children.
- ▶ Children under eight years of age must be kept away from the machine and the mains connection cable and plug/socket.
- ▶ Children eight years and older may only use the coffee machine unsupervised if they have been shown how to use it safely and recognise and understand the consequences of incorrect operation.
- ▶ Children must not be allowed to clean the coffee machine unsupervised.
- ▶ Children should be supervised when they are near the coffee machine. Do not allow them to play with it or to use the controls.
- ▶ Remember that coffee and espresso are not suitable drinks for children.
- ▶ Danger of suffocation.
Packaging, e.g. plastic wrappings, must be kept out of the reach of babies and children. Whilst playing, they could become entangled in packaging or pull it over their head and suffocate.

Warning and Safety instructions

Technical safety

- ▶ A damaged coffee machine is dangerous. Check it for any visible damage before setting it up. Never attempt to use a damaged coffee machine.
- ▶ Before connecting the coffee machine to the mains supply, make sure that the rating on the data plate corresponds to the voltage and frequency of the household supply. This data must correspond in order to avoid the risk of damage to the machine. Consult a qualified electrician if in any doubt.
- ▶ The electrical safety of this coffee machine can only be guaranteed when correctly earthed. It is essential that this standard safety requirement is met. If in any doubt please have the electrical installation tested by a qualified electrician.
- ▶ Do not connect the machine to the mains electricity supply by a multi-socket unit or an extension lead. These are a fire hazard and do not guarantee the required safety of the machine.
- ▶ Unplug the machine from the power supply immediately if you notice any damage or smell scorching, for example.
- ▶ Ensure that the mains connection cable cannot be pinched or damaged by any sharp edges.
- ▶ The mains connection cable should not hang down. Someone could trip over it with the risk of injury and damage the machine.
- ▶ The coffee machine must not be used in mobile installations such as ships.
- ▶ Only use the coffee machine in rooms where the ambient temperature is between 10 °C and 38 °C.
- ▶ Danger of overheating. Ensure that there is sufficient ventilation around the coffee machine. Do not cover it with tea towels etc. whilst it is in use.

Warning and Safety instructions

- ▶ If the coffee machine is installed behind a kitchen furniture door, it may only be used with the furniture door open. Do not close the furniture door while the coffee machine is in use.
- ▶ Protect the coffee machine from water and water spray. Do not immerse the machine in water.
- ▶ Repairs and other work by unqualified persons to the machine and the connection cable could be dangerous. The manufacturer cannot be held liable for unauthorised work. Repairs may only be carried out by a Miele authorised service technician.
- ▶ The manufacturer's warranty will be invalidated if the appliance is not repaired by a Miele approved service technician.
- ▶ Faulty components must only be replaced by genuine Miele Original spare parts. The manufacturer can only guarantee the safety of the machine when Miele replacement parts are used.
- ▶ The machine must be disconnected from the electricity supply during repair work.
- ▶ Disconnect the coffee machine from the power supply if it is not going to be used for a while.
- ▶ Use only Miele Original accessories with this machine. If accessories from other manufacturers are used, the warranty will be invalidated, and Miele cannot accept liability.

Warning and Safety instructions

Correct use



The spouts present a danger of burning or scalding. The liquids and steam dispensed are very hot.

► Please note:

- Keep well away from the area underneath the spouts when hot liquids and steam are being dispensed.
- Do not touch hot components.
- Hot liquid or steam could spatter from the spouts. Ensure that the central spout is clean and fitted correctly.
- Water in the drip tray can also be very hot. Take care when emptying it.

► Clean the coffee machine thoroughly before using for the first time (see "Cleaning and care").

► To avoid the risk of damage to the machine please note the following regarding water:

- Fill the water container with fresh, cold tap water only. Hot or warm water or other liquids could damage the coffee machine.
- Change the water every day to prevent a build-up of bacteria.
- Do not use mineral water. Mineral water will cause serious limescale deposits to build up in your machine and damage it.
- Do not use water from a reverse osmosis unit in this machine.

► Only fill the bean container with roasted coffee beans. Do not fill the bean container with coffee beans which have been treated or with ground coffee.

► Do not use coffee beans which have been treated with caramel, sugar or other substances including sugary liquids. Sugar will damage the coffee machine.

Warning and Safety instructions

- ▶ Only add ground coffee or cleaning tablets to the ground coffee chute. The cleaning tablets are used for degreasing the brew unit.
- ▶ Only use milk without additives. Additives in milk usually contain sugar and this will stick to the milk pipework.
- ▶ If using dairy milk make sure that it has been pasteurised.
- ▶ Do not place any alcohol mixtures which are alight underneath the central spout. The flames could ignite plastic components and cause them to melt.
- ▶ Do not use naked flames, e.g. a candle on or near the coffee machine. The coffee machine could catch fire with the risk of the fire spreading.
- ▶ Please note the following with regard to cleaning the coffee machine:
 - Disconnect the coffee machine from the power supply before cleaning.
 - Clean the coffee machine and the milk flask daily (see "Cleaning and care").
 - Ensure that all components in which milk is transported are cleaned on a regular basis.
Milk naturally contains bacteria that rapidly multiply if the milk pipework is not cleaned properly. Soiling in the appliance may be dangerous to health.
 - Do not use a steam cleaner to clean this machine. Steam could reach the electrical components and cause a short circuit.
- ▶ Descale the coffee machine regularly using the appropriate number of Miele descaling tablets for the water hardness level in your area. Descale the machine more frequently in areas with very hard water. Miele cannot be held liable for damage arising from insufficient descaling.

Warning and Safety instructions

- ▶ Degrease the brew unit regularly with Miele cleaning tablets. Depending on the natural oil content of the coffee used, the brew unit can become blocked quite quickly.
- ▶ Used coffee grounds should be disposed of with the organic rubbish or on the compost heap. Do not empty them down the sink, as they could block it.
- ▶ The machine must not be used for cleaning objects.



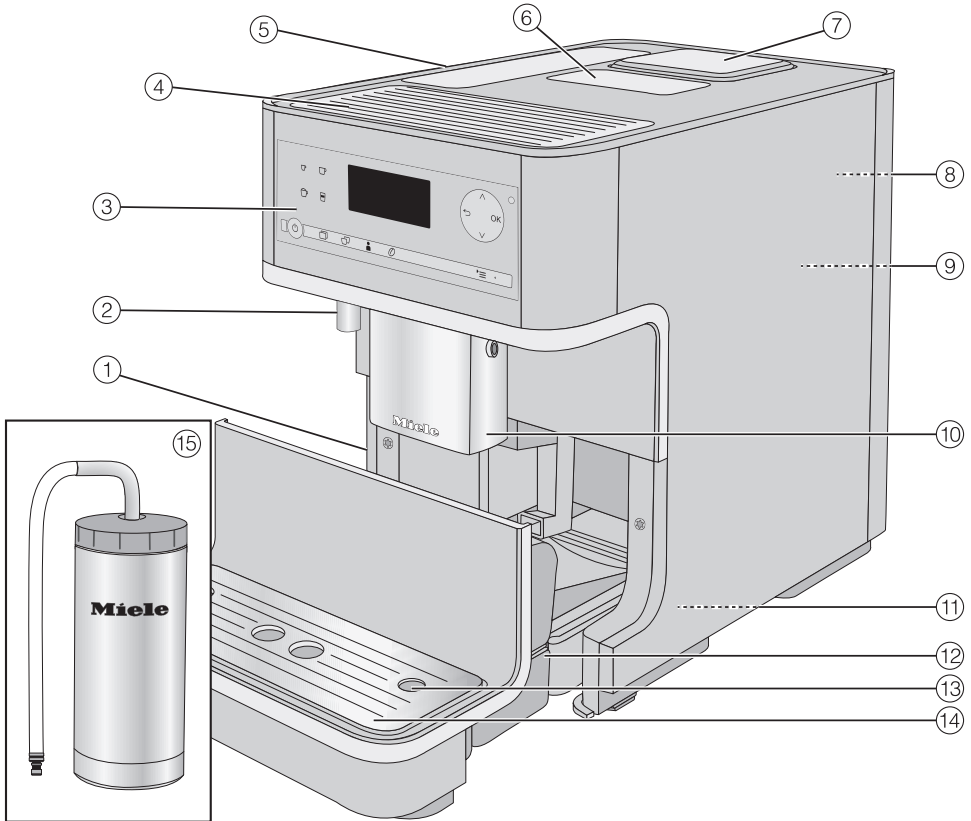





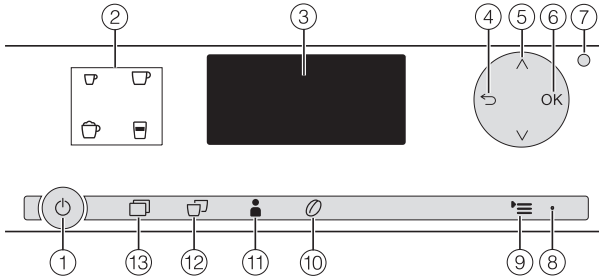



Guide to the machine



- ① Master switch
- ② Hot water spout
- ③ Controls and display
- ④ Cup heating
- ⑤ Water container
- ⑥ Ground coffee chute
- ⑦ Coffee bean container
- ⑧ Grinder setting (behind the service panel)
- ⑨ Brew unit (behind the service panel)
- ⑩ Central spout with cappuccinatore
- ⑪ Park position for milk pipework (behind the service panel)
- ⑫ Drip tray with lid and waste container
- ⑬ Milk tube aperture
- ⑭ Holder for drip tray cover and drip tray cover
- ⑮ Stainless steel milk flask

Controls and display



① On/Off 	For switching the coffee machine on and off
② Drink sensors	For making  Espresso  Coffee  Cappuccino  Latte macchiato
③ Display	Shows information about the current action or status
④ Back 	For returning to the previous menu, cancelling unwanted actions
⑤ Arrow sensors  	For displaying further options and highlighting a selection.
⑥ OK	For confirming display messages and saving settings
⑦ Optical interface	(for service technician use only)
⑧ LED	Flashes on and off when the machine is switched on and the display is black
⑨ Settings 	For displaying and changing settings
⑩ Parameters 	For changing drinks settings
⑪ Profiles 	For creating and managing profiles
⑫ Two portions 	For making two portions of a drink
⑬ Further programmes 	Other drinks such as long coffee, caffè latte, hot milk, milk froth and hot water Care programmes

The following accessories are included with your coffee machine **depending on model**:

- **Measuring scoop**
for ground coffee
- **Stainless steel milk flask MB-CM**
for keeping milk cool for longer (capacity 0.5 l)
- **Cleaning tablets**
for degreasing the brew unit (starter set)
- **Descaling tablets**
for descaling the water pipework (starter set)
- **Test strips**
for determining the water hardness level
- **Cleaning brush**
for cleaning the milk pipework

Miele also offers a range of optional accessories, as well as cleaning and conditioning products for your coffee machine.

- **Microfibre cloth**
for removing finger marks and light soiling
- **Cleaning agent for milk pipework**
for cleaning the milk system
- **Cleaning tablets**
for degreasing the brew unit
- **Descaling tablets**
for descaling the water pipework

These products and other useful accessories can be ordered via the internet at www.miele-shop.com or from Miele (see back of booklet for contact details).



www.miele-shop.com

Before using for the first time

Before using the coffee machine for the first time, please read these instructions and make yourself familiar with the appliance and its controls.

Before using for the first time

- Set up the coffee machine and remove any protective film (see "Installation").

Clean the machine thoroughly before filling it with water and coffee beans (see "Cleaning and care").

- Insert the plug of the coffee machine into the socket (see "Electrical connection").

Switching on for the first time

Switch the master switch on the left hand side of the machine to the "I" position.

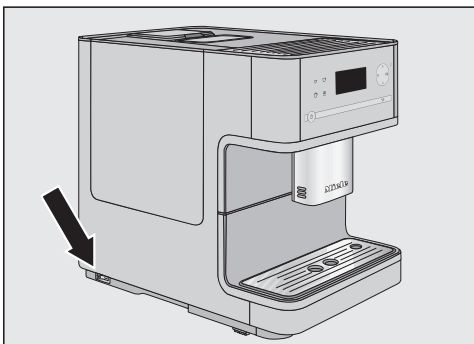

When you switch the machine on for the first time the following message will appear in the display: "Miele - Willkommen".

Language

- Use the arrow sensors to highlight the required language. Then touch OK.
- Use the arrow sensors to highlight the required country. Then touch OK.

The setting is now saved.

Time

- Touch the arrow sensors until the current hour appears. Then touch OK.
- Touch the arrow sensors until the current minutes appear. Then touch OK.

The setting is now saved.

The message "Set up successfully completed" will then appear in the display.

"Fill and replace the water container" will then appear in the display.

- Fill the water container with fresh, cold tap water.

Tip: To get the best out of your coffee machine and to set it up for your specific requirements, please continue to work through these operating instructions.

Before using for the first time

Water hardness

The water hardness level indicates how much calcium is dissolved in the water. The higher the calcium content, the harder the water, and the harder the water, the more often the coffee machine will need to be descaled.

The coffee machine measures the amount of water used and steam made. Depending on the level of water hardness set, more or fewer drinks can be dispensed before the appliance needs to be descaled.

Programme the coffee machine to the water hardness level of your area so that it functions correctly and does not get damaged. At the correct time a prompt will then appear in the display to descale the appliance.

The machine has four programmable levels:

Water hardness	Descriptive setting	Machine setting
0 - 8.4 °dH (0 - 1.5 mmol/l)	Soft	Soft 1
8.4 - 14 °dH (1.5 - 2.5 mmol/l)	Medium	Medium 2
14 - 21 °dH (2.5 - 3.7 mmol/l)	Hard	Hard 3
More than 21 °dH (more than 3.7 mmol/l)	Hard	Very hard 4

Measuring water hardness

You can measure the water hardness yourself using the enclosed test strip. Alternatively, your local water authority will be able to tell you the hardness of water in your area.

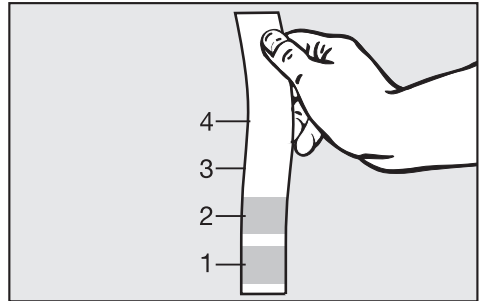

- Dip the strip in your drinking water for approximately one second, then shake off any excess water. The result will be evident after about a minute.

Now you can set the water hardness for your coffee machine.

Setting the water hardness level

- Touch .
- Use the arrow sensors to highlight "Water hardness". Then touch OK.
- Use the arrow sensors to highlight the required water hardness. Then touch OK.

The setting is now saved.

Operation

To operate the coffee machine, touch the sensors with your finger.

You are in the drinks menu when the display shows:

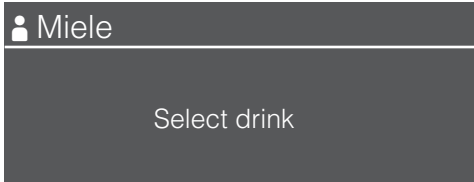

To make a drink, touch one of the drinks sensors.

You can find more drinks in the "Further programmes"  menu.

Selecting a menu and navigating within a menu

To select a menu, touch the relevant sensor. You will then be able to start an action or change settings in the menu.



A bar on the right-hand side indicates that further options or text are available. Use the arrow sensors to show these.

The setting which is currently selected will have a tick ✓ beside it.

To select an option

- Touch the ∨ and ∧ arrow sensors until the option you want is highlighted.

To confirm your choice:

- Touch OK.

Exiting a menu or cancelling an action

To exit the current menu:

- Touch ↶.

If none of the sensors have been touched for a while, the coffee machine will revert to the drinks menu.

Filling the water container

The quality of the water plays an important part in the quality of the coffee.

Warning. Bacteria can cause infection.

It is important to empty and fill the container with fresh tap water every day to avoid the risk of bacteria building up.

Hot or warm water or other liquids can damage the coffee machine.

Do not use mineral water in the water container. It will cause serious limescale deposits to build up in your machine and damage it.

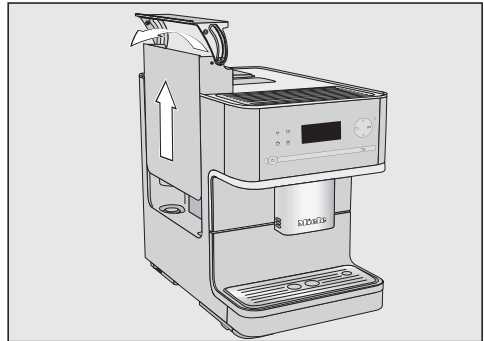

- Press the lid on the right hand side.
- Pull the water container up by the lid to remove it.
- Fill the water container with fresh, cold tap water up to the "Max." marker.
- Replace the water container.

Tip: If the water container is a little high or at a slant, check whether the surface that the water container sits on is dirty. If the water container is not sitting correctly, the drain valve will not be sealed. Clean the surface if necessary.

Filling the coffee bean container

Fill the coffee bean container with roasted coffee beans if you want to use freshly ground coffee beans for each cup of espresso or coffee.

Alternatively, you can make coffee or espresso with ready ground coffee (see "Making coffee or espresso using ready ground coffee").

Warning.

Only put roasted coffee beans in the container.

Anything else, including ground coffee, will damage the grinder.

Warning.

Do not use coffee beans that have been treated with sugar, caramel, or other substances and do not put liquids containing sugar in the coffee bean container. Sugar will damage the machine.

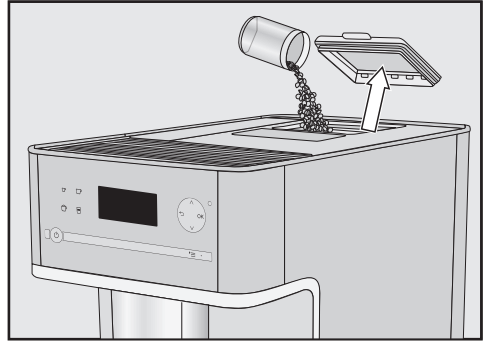

- Take the lid off the coffee bean container.
- Fill the container with roasted coffee beans.
- Replace the lid.

Tip: Only add enough beans to last for a few days as contact with air causes coffee beans to lose their aroma.

Switching on

Switch the master switch on the left hand side of the machine to the "I" position.

- Touch the On/Off sensor .

The appliance will begin rinsing after the heating-up phase. Hot water will come out of the central spout.

If the coffee machine still has an operating temperature higher than 60 °C , then rinsing will not take place.

"Select type of drink" will appear in the display.

If you do not touch any sensors or run the maintenance programme, the display will switch itself off after approx. 7 minutes to save energy. The right hand LED will flash on and off as long as the machine is switched on.

Touch any one of the sensors to wake the machine up again to make a drink.

Switching off

- Touch the On/Off sensor .

If the coffee machine has been used for making a drink it will rinse itself before switching off.

If a drink has been made using milk, the message "Place milk pipework in drip tray" will appear in the display.

Insert the end of the milk pipe into the aperture in the drip tray, then

- Touch OK.

If the milk system is not rinsed out before switching off, it will have to be rinsed the next time the machine is switched on.

Switching off for longer periods of time

If the coffee machine is not going to be used for a longer period of time:

- Empty the drip tray, the waste container and the water container.
- Clean all parts thoroughly, including the brew unit.
- Switch the machine off with the master switch and at the wall socket.

The time of day will not be saved. It will have to be reset next time the machine is switched on.

Pre-heating cups (cup heating)

Cups should always be pre-heated to allow the flavour of the coffee to develop and be retained. The smaller the volume of the coffee/espresso and the thicker the cup, the more important it is to pre-heat the cup.

You can use the cup heating surface on the top of the coffee machine to pre-heat coffee cups and glasses. The cup heating function must be switched on.

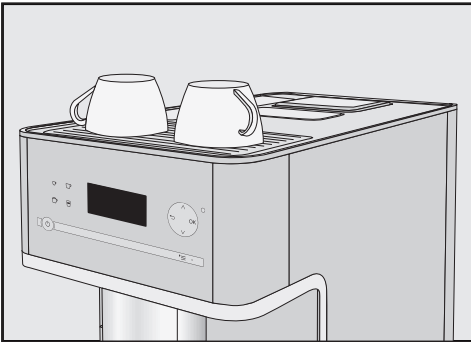

- Arrange the cups or glasses on the cup heating surface on the top of the coffee machine.

The cup heating surface will be heated continually until the coffee machine is turned off.

To switch cup heating on or off

- Touch .
- Select "Cup heating" and touch OK.
- Select the required option and touch "OK".

The setting is now saved.

Adjusting the central spout to the correct cup height

You can adjust the central spout to suit the height of the cup you are using so that the coffee or espresso will not cool down as quickly and the crema will have a better consistency.

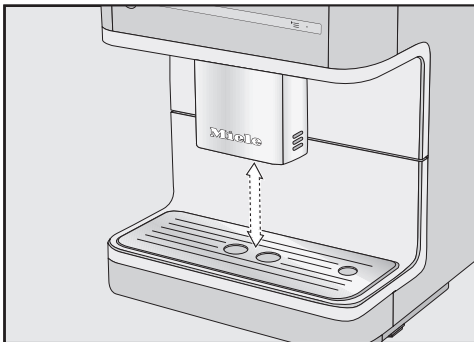

- Pull the central spout down to the same level as the rim of the cup.

or

- Push the spout up until there is enough room to fit the cup or mug underneath.

Making drinks

Espresso or coffee



- Place a cup under the central spout.
- Touch the sensor for the drink you want:
 - ☐ Espresso
 - ☐ Coffee
 - ☐ in "Further programmes": Long coffee

The coffee or espresso will be dispensed from the central spout into the cup.

To ensure that any coffee residues from the factory testing process are removed from the brewing system, please throw away the first two cups of coffee when using the coffee machine for the first time.

To make two portions

You can dispense two portions into one cup or dispense two portions into two cups at the same time.

To fill two cups at the same time:



- Place a cup under each coffee spout.
- Touch ☐☐.

The ☐☐ sensor will light up.

- Touch the sensor for the drink you want.

Two portions of the desired drink will be dispensed from the central spout.

Tip: If, after a while, you have not touch one of the drinks sensors, the "Double portion" ☐☐ option will revert back to single portions after a while.

Cancelling preparation

To cancel preparation:

- Touch the drinks sensor which is lit up, or  for drinks from "Further programmes" again.

Tip: Drink preparation can be cancelled by pressing the OK sensor as soon as "Stop" appears in the display.

When making **coffee with milk** or **two portions of a drink** you can cancel preparation of each stage individually.

- Touch OK.

Preparation will be cancelled.

Making coffee with ground coffee

To make espresso or coffee using ready ground coffee, add a portion of ground coffee to the ground coffee chute.

This gives you the option of preparing a cup of decaffeinated coffee, for example, even though the coffee bean container is filled with roasted coffee beans.

The coffee machine will recognise automatically that ready ground coffee has been added to the ground coffee chute.

Only **one** portion can be made at a time when using ready ground coffee or espresso.

Making drinks

Adding ready ground coffee

Use the measuring scoop supplied so that the correct amount is used.

Do not add more than one level scoop of ground coffee to the coffee chute. If too much is added, the brew unit will not be able to process the coffee.

The coffee machine will use all the ground coffee which has been added to the chute to make the next coffee.

- Open the ground coffee chute.

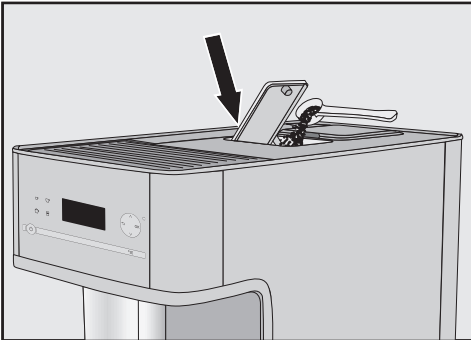

- Add one level scoop of ready ground coffee to the chute.
- Close the coffee chute.

"Use ground coffee?" will appear in the display.

Making coffee with ready ground coffee

If you want to make a drink with ready ground coffee:

- Select "Yes" and touch OK.

You can now select which type of drink you would like to make with ready ground coffee.

- Place a cup under the central spout.
- Select the drink you want.

The coffee machine will now make the drink you have chosen.

If you do **not** want to make a drink with ready ground coffee:

- Select "No" and touch OK.

The ground coffee will be directed into the waste container.

If you do not touch a drinks sensor within approx. 15 seconds, the ground coffee will also be directed into the waste container.

Drinks with milk

⚠ Caution. Danger of burning and scalding from the central spout. Liquids and steam dispensed from the spouts will be very hot.

Do not use milk with additives. Most additives contain sugar which will adhere to the milk pipework and damage the machine.

As soon as you select a drink containing milk the machine will start to heat up. The milk will be drawn up into the central spout where it is heated by steam and also frothed for drinks requiring milk froth.

If you have not made any milk drinks for a while, rinse the milk system through before making the first drink. This will flush out any bacteria.

The following drinks with milk can be made:

Cappuccino consisting of approx. 2/3 milk froth and 1/3 espresso.

Latte macchiato consisting of 1/3 each of hot milk, milk froth and espresso.

Caffè latte consisting of hot milk and coffee.

Hot milk or **milk froth** can also be made.

Stainless steel milk flask

The stainless steel flask keeps milk cool for longer. Good milk froth can only be made with cold milk (< 13°C).



- Connect the stainless steel suction tube to the inside of the lid. Make sure that the slanted end is pointing downwards as shown.
- Fill the milk flask up to max. 2 cm below the rim with milk. Seal the milk flask with the lid.
- Connect the stainless steel angled end of the milk tube to the top of the lid until it clicks into place.

Making drinks



- Place the milk flask on the right hand side of the coffee machine. Connect the other end of the milk tube to the central spout.

You can use bottled milk or cartons.

The milk tube for cartons and other suitable containers is located behind the machine front.

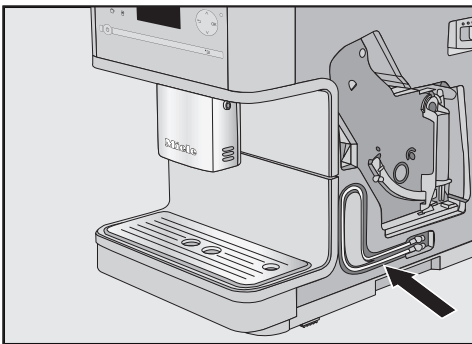

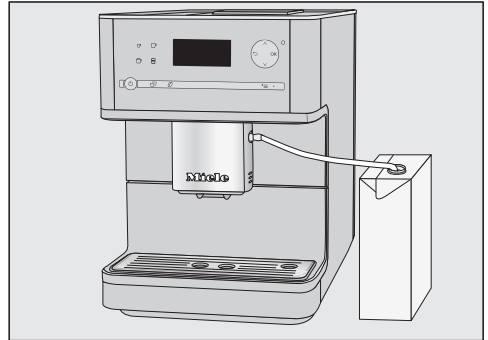

- Connect the milk pipe to the aperture in the central spout.



- Place a container with sufficient milk beside the coffee machine on the right hand side.
- Place the end of the milk tube in the container making sure that it is sufficiently immersed in the milk.

Making drinks with milk

- Place a suitable container underneath the central spout.
- Touch the sensor for the drink you want:

-  Cappuccino
-  Latte macchiato
-  in "Further programmes":
Caffè Latte, hot milk or milk froth

The selected drink will now be made.

Preparing hot water

 Danger of burning and scalding on the hot water spout. The water dispensed is very hot.

Please note that the water dispensed is not hot enough for making tea.

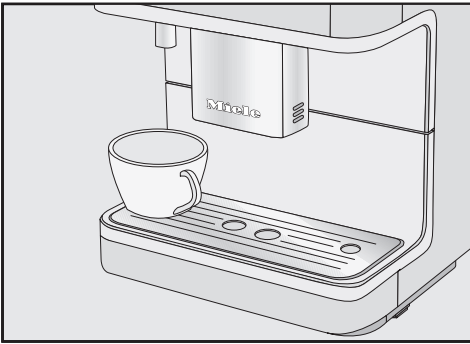

- Place a suitable container underneath the hot water spout.
- Touch .
- Select "Hot water" and touch "OK".

Hot water is dispensed into the container under the spout.

To cancel preparation

- Touch OK.

Preparation will be cancelled.

Making drinks using a profile

You can enter individual profiles to cater for different tastes and preferences (see "Profiles").

If you have already created your own profile, you can select this to make a drink according to your own tastes.

- Touch .

- Select the required profile with the arrow sensors and touch OK.

The name of the profile will appear in the display to show that a profile has been selected.

You can now make the drink you want.

Coffee the way you like it

You can customise your coffee machine to suit the type of coffee you are using. The "Parameters" menu  allows you to adjust the amount of coffee that is ground, set the brew temperature and deselect the "Pre-brewing" option. The parameters for each type of coffee can be individually specified.

The grinder can also be set to suit the type of coffee beans being used.

Grinder setting

When the beans are ground correctly, the coffee or espresso will flow evenly into the cup with a good crema.

The crema should have an even nutbrown colour.

There are various ways to tell whether the coffee grinder is set correctly.

The coffee has been **too coarsely** ground if:

- Espresso or coffee flows into the cup too quickly.
- The crema is very pale and uneven.

Set a finer grinder setting.

The coffee has been **too finely** ground if:

- Espresso or coffee only trickles into the cup.
- The crema is dark brown.

Set a coarser grinder setting.

To avoid damaging the grinder, please note the following:

Only adjust the grinder one setting at a time.

Grind the coffee beans again if you want to adjust the grinder to the next setting.

- Open the door.

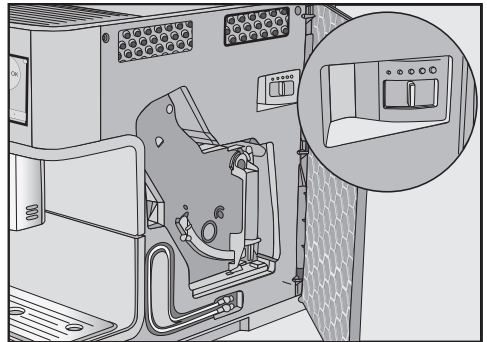

- Push the slide control one setting to the left (for finer grinding) or one setting to the right (for coarser grinding).
- Close the machine door.
- Make one cup of coffee.

Adjust the grinder setting again.

The altered grinder setting will not be used until after the second coffee has been dispensed.

Displaying and changing the parameters of a drink

- Touch \emptyset .

The \emptyset sensor will light up.

- Select the drink you want and touch OK.

The current settings for the amount of coffee, brewing temperature and pre-brewing will be displayed for this drink.

Amount of coffee

The coffee machine can grind and brew 6-14 g of coffee per cup. The greater the quantity, the stronger the coffee or espresso.

There are various ways to tell whether the amount of coffee is set correctly.

The amount of coffee is **too low** if:

- Espresso or coffee flows into the cup too quickly.
- The crema is very pale and uneven.
- The espresso or coffee lacks body.

Increase the amount of coffee so that more ground coffee is brewed.

The amount of coffee is **too high** if:

- Espresso or coffee only trickles into the cup.
- The crema is dark brown.
- The espresso or coffee tastes bitter.

Decrease the amount of coffee so that less ground coffee is brewed.

- Select "Amount of coffee" and touch OK.

- Use the arrow sensors to change the amount.
Then touch OK.

The setting is now saved.

Brew temperature

The ideal brewing temperature will depend on

- the type of coffee being used,
- whether an espresso or a coffee is being made, and
- the altitude of the region.

If the coffee machine is located at more than 2000 metres above sea level, the brewing temperature needs to be set lower due to the change in pressure.

This is because the boiling point for water at a high altitude above sea level is lower than the boiling point for water at sea level.

The coffee machine has five brewing temperatures.

Tip: Not all types of coffee can withstand high temperatures. Certain types are too delicate - the crema on top would not be as good and the taste would be impaired.

- Select "Brew temperature" and touch OK.
- Select the required temperature and touch "OK".

The setting is now saved.

Coffee the way you like it

Pre-brewing

When the pre-brewing function is switched on, the freshly ground coffee is first moistened with a little hot water. Then the remaining water is forced through the moistened coffee at high pressure. This helps release the flavour of the coffee.

You can set pre-brewing for a normal length of time or an extra long length of time. Alternatively, you can switch off the " Pre-brewing " function.

The machine is supplied with the "Pre-brewing" function switched off.

- Select "Pre-brewing" and touch OK.
- Select the setting you want and touch OK.

The setting is now saved.

The flavour of the coffee produced depends not just on the type of coffee used, but also on the amount of water used.

You can programme the amount of water to suit the size of your cups and the type of coffee you are using.

For coffee drinks that use milk you can also set the amount of milk or milk froth to be dispensed. You can also set the portion sizes for hot milk and milk froth alone.

Each type of drink has a maximum portion size that can be programmed into the machine. The coffee machine halts preparation of the coffee once this portion size has been reached. The maximum possible portion size for this type of drink is then saved in the machine.

The changed portion size is always saved in the current User profile. The name of the current profile appears in the top left-hand side of the display.

There are two ways to start programming the portion amount:



- Either by touching the drink sensor when you are making a coffee, or
- by selecting "Portion size" from the "Parameters" menu.

If the water container becomes empty whilst making a drink, the machine will stop programming the portion size. The portion size will **not** be saved.

Tip: To cancel changing the portion size, touch the drinks sensor which is lit up, or touch  for "Further programmes".

Changing portion size while making a drink

Portion sizes for Espresso and Coffee

- Place the desired cup under the central spout.
- Touch  or  until "Change" appears in the display.

The selected drink will now be made.



You can set the amount as soon as "Save" appears in the display.

- When the cup is filled up to the level you want, touch OK.

The portion size programmed in will now be dispensed every time that particular drink is selected.

Portion size

Portion sizes for cappuccino and latte macchiato

- Place a suitable container underneath the central spout.
- Touch  or  until the ingredients for that drink are shown in the display.

Cappuccino: milk froth, espresso

Latte macchiato: hot milk, milk froth, espresso

- Select all the components you want to change with the arrow sensors. Confirm these individually with the OK sensor.

A tick before the ingredient shows that it has been selected.

- Select "Start" and touch OK.

The coffee machine will start dispensing. You can now set the portion size for each selected component as soon as "Save" appears in the display.

- When the quantity for each ingredient reaches the level you want, touch OK.
- Save the required portion size for the selected components.

The programmed mix of ingredients and portion sizes will now be dispensed every time that particular drink is selected.

Portion sizes for caffè latte, hot milk and milk froth

- Place a suitable container underneath the central spout.
- Touch .
- Select the drink you want.
- Select "Portion size" and touch OK.

You can change the amount of each component for **caffè latte** (hot milk, coffee) as described under "Portion sizes for cappuccino and latte macchiato".

For **milk froth** and **hot milk**, follow the instructions described under "Setting portion sizes for espresso and coffee".

Changing portion sizes in the "Parameters" menu

- Touch .
- Select the drink you want and touch OK.
- Select "Portion size" and touch OK.

Now proceed as for changing the portion size during drink preparation

Changing the portion size for different profiles

You can set the portion size for individual drinks for each profile.

- Touch .
- Select the profile you want.

The name of the current profile is shown in the top left of the display.

Now you can either set the portion size by selecting " Portion size " in the " Parameters "  menu, as previously described, or set it while making a drink.

Profiles

You can enter individual profiles to cater for different tastes and preferences. For each individual profile you can select the portion sizes for each drink (see "Setting the portion size").

The name of the current profile is shown in the top left of the display.

Calling up a profile

- Touch .

The  sensor will light up.

You can now "Create a profile".

If you have allocated a profile in addition to the Miele standard profile, you have the following options:

- **Select profile** from the profiles which are already allocated.
- **Change name** if you want to alter the name of a profile.
- **Delete profile** if you want to delete a profile.
- **Change profile**, to programme the coffee machine so that it changes back to the Miele standard profile automatically after each drink is dispensed or so that it retains the most recently selected profile.

TIP Touch  or  to return to the main menu.

Creating a profile

- Select "Create profile" and touch OK.

Letters will appear in the display that you can select with the arrow sensors. You can use the arrow sensors to select from numbers, upper case and lower case letters.

- Select the character you want and touch OK.

The character you have chosen will appear in the top line of the display.

- Repeat the process until the name required appears in the top line of the display.

TIP If you make a mistake, select the  symbol to delete the last character.

When you have finished making your entry and want to **save** it,

- use the arrow sensors to highlight the tick  and touch the OK sensor.

If you do **not** want to save your entry:

- Touch  until all characters have been deleted and the coffee machine returns to the previous selection.

Tip: The last created profile is selected as the current profile.

Select profile

This selection is only possible if a profile has been allocated in addition to the Miele standard profile.

- Touch "Select profile" and touch OK
- Select the profile you want and touch OK.

The name of the profile is shown in the top left of the display.

Change name

This selection is only possible if a profile has been allocated in addition to the Miele standard profile.

- Select "Change name" and touch OK.

Now proceed as described in "Creating a profile".

- Select ↵ to delete a character,
- To enter new characters, select the relevant character and confirm with OK.
- Save the new name by selecting "✓" in the display and touching the OK sensor.

Delete profile

This option is only possible if a profile has already been created in addition to the standard Miele profile. The standard Miele profile cannot be deleted.

- Select "Delete profile" and touch OK.
- Select the profile you wish to delete and touch OK.

The profile will be deleted.

Profiles

Changing a profile

You can programme the coffee machine so that it changes back to the Miele standard profile automatically after each drink is dispensed, so that the Miele profile is always active when the machine is switched on or so that it retains the most recently selected profile.

- Select "Change profile" and touch OK.

You now have the following options:

- **Manually:** The selected profile will be retained until you select another profile manually.
 - **After each use:** The machine will change back to the Miele standard profile automatically after a drink is dispensed.
 - **When switched on:** Each time the machine is switched on it will automatically select the Miele standard profile regardless of which profile was selected before the machine was last switched off.
- Select the required option and touch "OK".

You can use the "Settings" menu to customise the coffee machine to suit your individual requirements.

Calling up the "Settings" menu

- Touch '☰.

You can now check or change the settings.

Options which are currently selected will have a tick ✓ next to them.

Touch ↶ if you want to access the previous menu.
Touch '☰ to return to the drinks selection menu.

Changing and saving settings

- Touch '☰.
- Select the required setting with the arrow sensors and touch OK.
- Use the arrow sensors to highlight the required option.
- Touch OK.

The setting is now saved.

Settings

Overview of available settings

The factory setting for each option is shown in **bold**.

Option	Available settings
Language	deutsch , english and other languages Country
Time	Clock format 12 h / 24 h Set
Timer	Set Switch on at / Switch off after (1:00) / Switch off at Activate Switch on at (Yes / No) / Switch off at (Yes / No)
Eco mode	On / Off
Lighting	Display brightness
Info	Number of drinks Total portions / Espresso / Coffee / Cappuccino / Latte macchiato / Caffè Latte / Milk froth / Hot milk / Hot water No. of uses until appliance needs descaling No. of uses until brew unit needs degreasing
System lock	On / Off
Water hardness	soft medium hard very hard
Display brightness	-
Volume	Buzzer tones Keypad tone
Cup heating	On / Off
Showroom programme	Demo mode On/ Off
Factory default	Do not reset Reset

Language

You can select a language and country for all display texts.

Tip: If you select the wrong language by mistake, you can find the "Language" option by following the flag symbol .

Time

You can set the clock display and the time of day.

Clock format

The options are:

- 24-hour display (24 h)
- 12-hour display (12 h)

Setting the time

Use the arrow sensors to set the hours and minutes.

Timer

The timer offers the following options:

The coffee machine

- switches on at a particular time, e.g. in the morning for breakfast ("Switch on at").
- switches off at a particular time ("Switch off at").
- switches off after a particular length of time if no sensors have been pressed ("Switch off after").

For "Switch on at" and "Switch off at" to be set, the timer must be **activated**.

Switch on at

Please note that the coffee machine will **not** switch on at the required time if you have activated the system lock.

Use the arrow sensors to set the hours and minutes.

If the coffee machine has switched itself on **three times** via the "Switch on at" timer function and no drinks have been dispensed, the machine will not switch itself on again automatically. This prevents the coffee machine from switching itself on unnecessarily, for example whilst you are away on holiday.

Settings

The programmed times will, however, remain in memory and will be reactivated after manually switching the machine on again.

Switch off at

Use the arrow sensors to set the hours and minutes.

If you have not used the coffee machine for a long time, the saved times will be reactivated after manually switching the machine on again (see "Switch on at").

Switch off after

If none of the sensors has been pressed or no drink has been prepared, the coffee machine will switch itself off after 30 minutes to save energy.

You can change this pre-setting using the arrow sensors to a time of between 15 minutes and 9 hours.

Activating and deactivating the timer

When the system lock is activated, the "Switch on at" option for the timer cannot be selected.

- Select the timer function you want to use.

The selected option will have a next to it.

- Touch the arrow sensor repeatedly until " Accept " is highlighted. Touch the OK sensor.

Eco mode

The Eco mode is an energy-saving mode.

If Eco mode is switched on, the coffee machine heats up anew before each drink preparation, making preparation times longer.

If Eco mode is switched off, the coffee machine heats up for the first drink preparation after switching on. After that the steam system remains heated up and much more energy is used.

The coffee machine will indicate that the energy consumption has been altered.

Lighting

Change the display brightness using the arrow sensors.

To switch off the lighting,

- touch the arrow sensor until no segments are filled and "Switched off" appears.

If no buttons are pressed or maintenance programmes carried out, the lighting will switch off after approximately 7 minutes to save energy.

Info (display information)

The "Info" option allows you to see how many portions of each drink have been made.

You can also see whether more than 50 portions can be dispensed before the machine needs to be descaled ("No. of portions until descaling") or before the brew unit needs to be degreased ("No. of portions until degreasing").

To return to the previous display:

- Touch OK.

Locking the coffee machine (System lock)

You can lock the coffee machine to prevent it being used without your knowledge, by children, for example.

Activating and deactivating the system lock

When the system lock is activated, the "Switch on at" option for the timer will not work.

Overriding the system lock

While "To unlock, press OK sensor for 6 seconds" is showing in the display,

- touch the OK sensor for 6 seconds.

As soon as you switch the coffee machine off, the system lock will be activated again and the coffee machine is locked.

Water hardness

See "Setting up and using the coffee machine" for information about water hardness.

Display brightness

Change the display brightness using the arrow sensors.

Volume

You can set the volume of buzzer and keypad tones using the arrow sensors.

To switch the tones off:

- touch the arrow sensor  until no segments are filled and "Switched off" appears.

Cup heating

See "Pre-heating cups (cup heating)" for more information.

Settings

Factory default

You can reset the settings back to the ones which were set when the coffee machine was delivered.

Please refer to the "Overview of available settings" chart for the factory settings which are shown in bold.

The following settings will **not** be reset:

- Language
- Time of day
- Number of drinks dispensed (Info)
- Profiles
- Portion size

Showroom programme (Demo mode)

Do not activate this setting for domestic use!

The coffee machine can be presented in Miele galleries or stores with the "Showroom programme". The machine will light up but drinks cannot be dispensed and other actions cannot be carried out.

If you activate the Demo mode, you cannot switch the appliance off with the On/Off sensor .

Quick guide

Clean the coffee machine regularly to avoid a build-up of bacteria.

Recommended frequency	What do I have to clean / maintain?
Daily (before you turn the coffee machine off)	Clean the water container
	Clean the waste container
	Clean the drip tray and grille
	Clean the stainless steel milk flask
Weekly (or more often for very heavy soiling)	Clean the central spout with cappuccinatore
	Clean the casing (particularly important after descaling the machine)
	Remove the brew unit and wash by hand
Approx. after 200 portions	Degrease the brew unit (with cleaning tablets)
Depending on the hardness of the water	Descale the machine
As required	Clean the coffee bean container
	Clean the ground coffee chute

Some parts of the coffee machine are dishwasher-safe. However, cleaning these in the dishwasher frequently can cause them to become discoloured due to regular contact with food residues (e.g. tomatoes) in the dishwasher. The surface of these parts can also become damaged.

The following must **only** be cleaned by hand:

- Brew unit
- Central spout cover
- Water container lid
- Bean container lid
- Stainless steel milk flask
- Holder for drip tray cover (on the drip tray)

Cleaning and care

 Danger of burning and scalding on hot components or by hot liquids.

Always allow the coffee machine to cool down before cleaning it. Caution. Water in the drip tray can be very hot.

Do not use a steam cleaner to clean the coffee machine. Steam could cause a short circuit.

To avoid damaging the surfaces of your appliance, do not use:

- cleaning agents containing soda, ammonia, acids or chlorides,
- solvent-based cleaning agents,
- cleaning agents containing descaling agents,
- stainless steel cleaning agents,
- dishwasher cleaner,
- oven cleaner,
- abrasive cleaning agents, e.g. powder cleaners and cream cleaners,
- hard, abrasive sponges, e.g. pot scourers, brushes or sponges which have been previously used with abrasive cleaning agents,
- melamine eraser blocks,
- sharp metal tools.

Rinsing the machine

After a coffee has been dispensed, the machine is rinsed before it switches off. This removes any residual coffee grounds.

You can also rinse the machine manually.

- Touch .
- Touch the \wedge arrow sensor repeatedly until "Maintenance" is highlighted. Touch OK.
- Select "Rinse appliance" and touch OK.

The pipework will now be rinsed through.

You may also be prompted to insert the end of the milk pipe into the drip tray.

Milk pipework

Ensure that all components in which milk is transported are cleaned on a regular basis.

Milk naturally contains bacteria that rapidly multiply if the milk pipework is not cleaned properly. Soiling in the appliance may be dangerous to health.

Rinsing the milk pipework

Milk residue can clog up the milk pipes. If a drink has been made using milk the coffee machine will prompt you to rinse the pipework when you switch the machine off.

You can also rinse the milk pipework manually.

- Touch .
- Select "Maintenance" and touch OK
- Select "Rinse milk pipework" and touch OK.

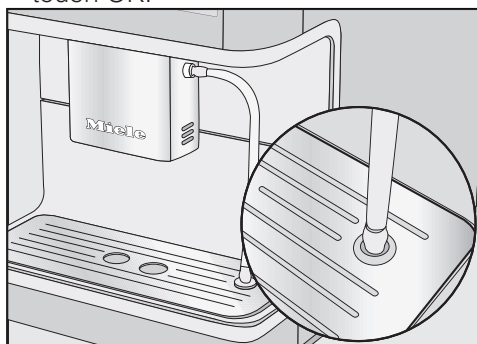

- When prompted, place the end of the milk tube into the right-hand aperture in the drip tray.
- Confirm with OK.

The milk pipework will now be rinsed.

Cleaning the milk pipework

The milk pipework must be cleaned at least once a week. The coffee machine will prompt you when this needs to be done.

- Confirm with OK.

When you confirm the message "Clean milk pipework" with OK, the internal counter for the cleaning interval will be reset. You will **not** be reminded again.

There are two options:

- You can remove and dismantle the central spout with its integrated cappuccinatore and either wash it in the dishwasher or by hand with hot water and a little washing-up liquid.
- Or you can clean the milk pipework using the "Clean milk pipework" maintenance programme together Miele cleaning agent for milk pipework.

Cleaning and care

Cleaning the milk pipework with Miele cleaning agent for milk pipework

The cleaning process cannot be cancelled once it has started. The process has to be completed through to the end.

- Touch .
- Select "Maintenance" and touch OK
- Select "Clean milk pipework" and touch OK.

The process will start.

- Follow the instructions given in the display.

When the message "Place milk pipe in cleaning agent" appears in the display dissolve the cleaning agent in water:

Making up the cleaning solution

The cleaning agent for milk pipework has been specially developed for Miele coffee machines. You can purchase it from Miele or online at www.miele-shop.com (depending on country).

To prevent the risk of damage, only use this cleaning agent with your Miele coffee machine.

- Dissolve the powder in a container with 200 ml of lukewarm water. Stir the solution with a spoon until it has fully dissolved.

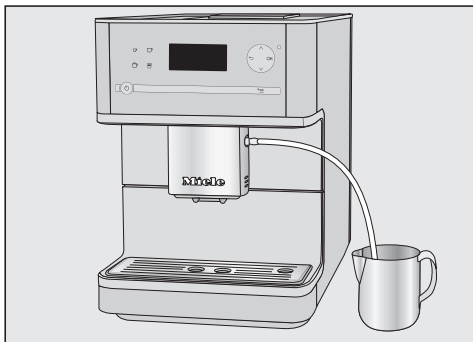

- Place the container next to the machine and hang the milk pipe in the solution. Make sure it is placed sufficiently far into the cleaning solution.
- Touch OK.
- Follow the further instructions given in the display.

The cleaning process is finished when rinsing has finished.

Central spout with cappuccinatore

Clean the central spout cover **by hand** only using warm water and a little washing-up liquid.

All other parts are dishwasher safe.

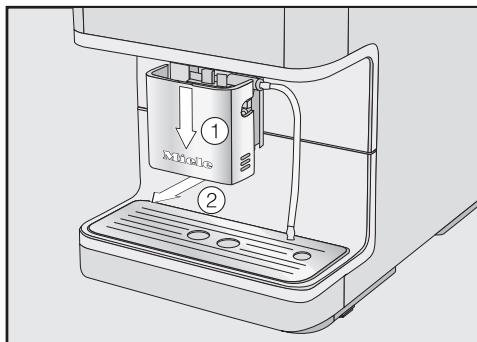

- Push the central spout right down and remove the stainless steel cover by pulling it off towards you.

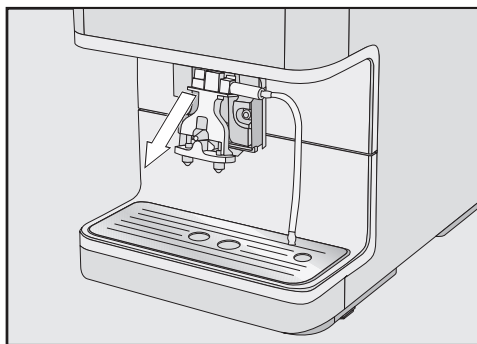

- Pull the dispensing unit off towards you.

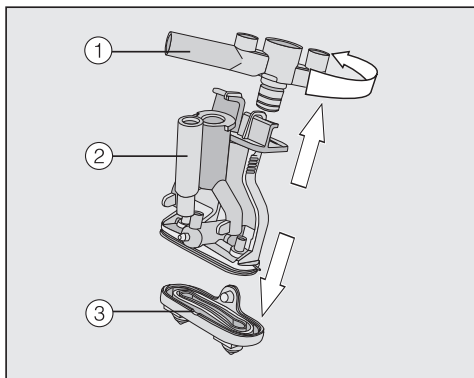

- Twist upper section ① with the holder for the milk pipework and pull it off. Then pull the Y-shaped piece ② off. Release the spouts ③.
- Clean all parts thoroughly.

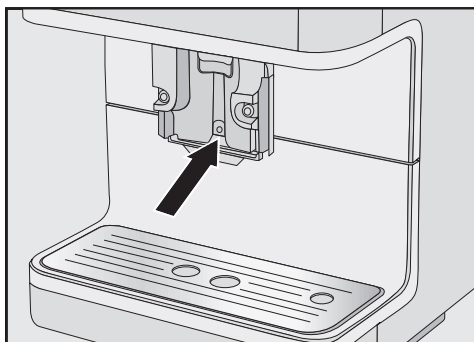

- Clean the surfaces of the central spout with a damp cloth.

Cleaning and care

If the milk pipe is blocked, clean it under running water with the brush supplied.

- Insert the brush in the tube and move it back and forth as far as it will go until all milk residue has been removed.
- Fit the dispensing unit back together.
- Push the dispensing unit back onto the central spout. Press firmly to ensure the spouts at the bottom connect correctly with the edge of the dispenser.
- Replace the stainless steel cover and connect the milk pipe if applicable.

Milk flask

The milk flask should be taken apart and cleaned every day.

- Clean all parts **by hand only** using hot water and a little washing-up liquid. Use the cleaning brush supplied to remove milk residues from the milk pipework if necessary.
- Rinse all parts carefully under running water. Residual washing-up liquid can affect the taste of milk from the machine and the quality of the milk froth. Dry all parts afterwards.
- Reassemble the milk flask.

Clean the water container

Clean the water container lid **by hand only** using hot water and a little washing-up liquid.

Change the water every day to prevent a build-up of bacteria.

Make sure that the valve, the underside of the water container and the surface the water container sits on are clean. Otherwise the water container will not sit correctly.

- Press the lid on the right hand side.

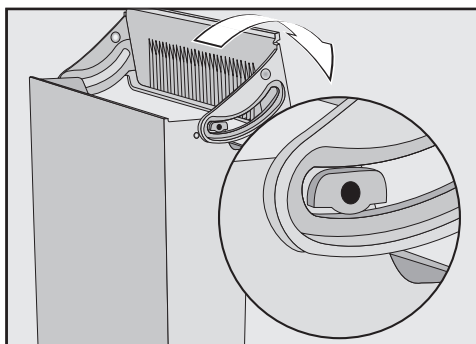

- Pull the water container up by the lid to remove it.
- Take the lid off the container and wash it by hand.
- The water container can be cleaned in the dishwasher, or by hand using warm water and a little washing-up liquid. After cleaning, dry the water container.
- Carefully clean and dry the surface the water container sits on, particularly the recesses.
- Fit the lid back on the container.

Drip tray cover

- Remove the drip tray cover from the drip tray.
- The drip tray cover can be cleaned in the dishwasher, or by hand using warm water and a little washing-up liquid.
- Dry the drip tray thoroughly.

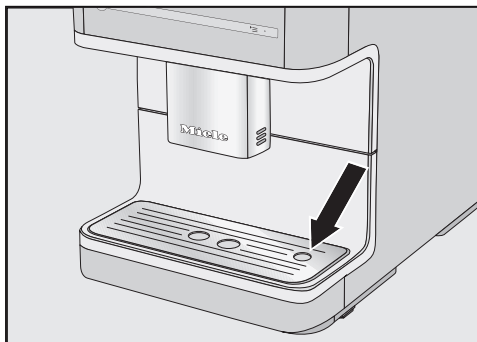

- Replace the drip tray cover making sure that the aperture for the milk tube is on the right hand side.

Cleaning and care

Drip tray and waste container

Clean the drip tray and waste container **every day** to avoid unpleasant smells and mildew.

The waste container is located in the drip tray. Water from rinsing also collects in the waste container.

A prompt will appear in the display when the drip tray and/or the waste container is full and needs to be emptied. Empty the drip tray **and** the waste container.

Danger of burning!

If the rinsing process has just finished, wait a while before removing the drip tray as the water used for rinsing will run out of the coffee spouts.

- Push the central spout up as far as it will go.

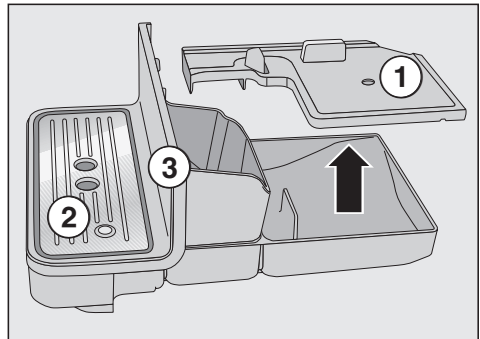

- Then pull the drip tray carefully out of the machine. Take the lid off ①.
- Empty the drip tray **and** the waste container.
- Remove drip tray cover ② and holder ③ for the drip tray.
- Clean all parts thoroughly.

Clean the drip tray holder **by hand only** using hot water and a little washing-up liquid. All other parts are dishwasher-safe.

- Clean the interior of the machine underneath the drip tray.
- Reassemble all parts and place the drip tray back in the coffee machine.

Make sure that the drip tray is pushed right into the coffee machine as far as it will go.

Bean container and ground coffee chute

 Disconnect the coffee machine from the power supply before cleaning.

Tip: Use a vacuum cleaner to remove any coffee residues from the bean container and the ground coffee chute.

- Open the bean container.
- Remove any coffee beans.
- Clean the bean container with a dry, soft cloth.

The bean container can now be refilled.

If necessary, clean the ground coffee chute:

- Open the ground coffee chute.
- Remove any ground coffee.

Brew unit

 Disconnect the coffee machine from the power supply before cleaning.

Clean the brew unit **by hand only using warm water**. Do not use washing-up liquid.

The moving parts of the brew unit are lubricated. Washing-up liquid will damage the brew unit.

Clean the brew unit once a week.

Removing and cleaning the brew unit by hand

The brew unit can be removed for cleaning. To do this:

- Open the door.

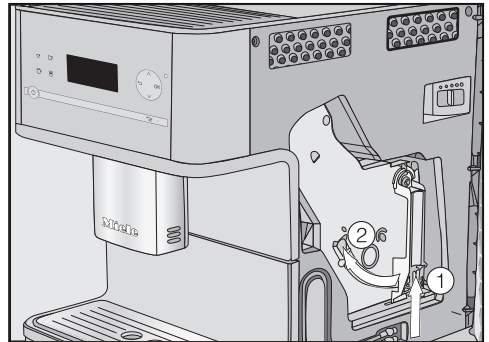

- Press the button under the handle of the brew unit ① and, whilst doing so, turn the handle to the left ②.
- Carefully pull the brew unit out of the coffee machine.

Cleaning and care

If you cannot remove the brew unit or can only do so with difficulty, the brew unit is not in the correct position (See "Problem solving guide").

After taking the brew unit out of the machine do **not** change the position of the brew unit handle, as this would cause the brew unit to be out of alignment and you will not be able to push it back into the coffee machine.

- Clean the brew unit **by hand under warm running water** without using washing-up liquid.

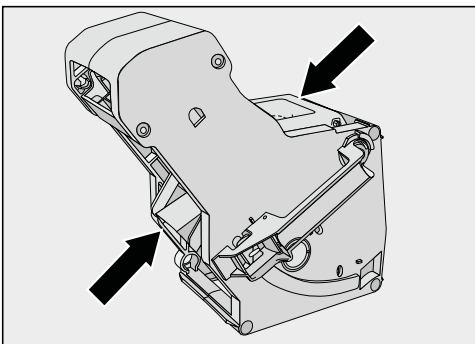

- Wipe any remaining coffee off the two filters (see arrows). One filter is located in the funnel and the other to the left of the funnel.
- Dry the funnel to prevent ground coffee sticking to it the next time a coffee is prepared.
- Clean the inside of the coffee machine. Use your vacuum cleaner to remove dry coffee grounds.

To replace the brew unit, repeat the previous steps in the reverse order:

- Push the brew unit back into the coffee machine, making sure it goes in straight.

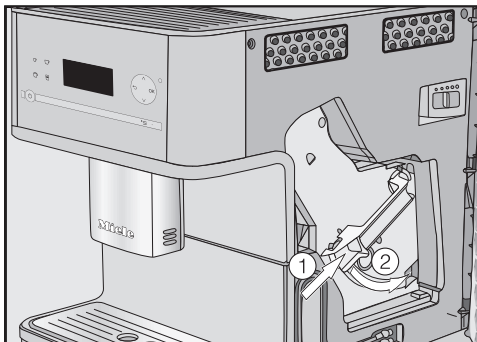

- Press the button under the handle of the brew unit ① and, whilst doing so, turn the handle to the right ②.
- Close the machine door.

Degreasing the brew unit

Depending on the natural oil content of the coffee used, the brew unit can become blocked quite quickly.

Degrease the brew unit regularly with the Miele cleaning tablets supplied. This ensures you can continue to make aromatic coffees and guarantees trouble-free operation of your coffee machine.

The cleaning tablets for degreasing the brew unit have been specially developed for Miele coffee machines. You can purchase the Original Miele cleaning tablets at www.miele-shop.com (depending on country) or from Miele.

After 200 portions have been dispensed, "Degrease the brew unit" will appear in the display.

- Touch OK.

This message will not go out until the brew unit has been degreased.

To degrease the brew unit:

- Touch .
- Select "Maintenance" and touch OK
- Select "Degrease the brew unit".

The cleaning process cannot be cancelled once it has started. The process has to be completed through to the end.

- Touch OK.

The process will start.

- Follow the instructions given in the display.

When "Place a cleaning tablet in the ground coffee chute and close the chute" appears in the display:

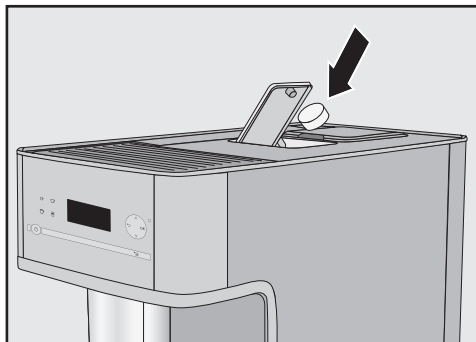

- Place a cleaning tablet into the coffee chute.
- Follow the further instructions given in the display.

The cleaning process is finished when rinsing has finished.

Cleaning and care

Housing

External surfaces may suffer discolouration or damage if soiling is left on them for too long. Remove soiling immediately.

Make sure that water cannot get behind the display.

All external surfaces are susceptible to scratching and can suffer discolouration if they come into contact with unsuitable cleaning agents.

Wipe up any spillages or splashes of descaling agent immediately.

- Switch the coffee machine off.
- Clean the front of the machine with a solution of warm water and a little washing-up liquid applied with a soft sponge. Then dry all parts with a soft cloth.

Tip: You can also clean the appliance front with the Original Miele all purpose microfibre cloth.

When descaling the machine, cover delicate surfaces and natural flooring to prevent damage from splashes of descaling solution. Ensure that any splashes of descaling solution are wiped up immediately.

Limescale builds up in the coffee machine through use. How often the appliance needs to be descaled will depend on the water hardness level in your area. The machine should be descaled regularly to ensure that it functions correctly.

The machine will guide you through the descaling process. Various messages will appear in the display, e.g. you will be prompted to empty the drip tray or fill the water container.

Descaling **must be carried out**.

The coffee machine prompts you when it needs to be descaled. "No. of portions until appliance needs descaling: 50" appears in the display. Each time a drink is prepared, the coffee machine displays the number of portions remaining until descaling must be carried out.

- Touch OK.

When the number of remaining portions reaches 0, the machine will lock out. Then "Descal appliance" will appear in the display.

You can switch off the coffee machine if you do not want to descale it at this point in time. However, you will be not be able to make any more drinks until descaling has been carried out.

Descaling after prompt appears in the display

The descaling programme cannot be cancelled once you have touched OK. The programme has to be completed through to the end.

To start the descaling programme straight away:

- Touch OK.

The process will start.

- Follow the instructions given in the display.

When "Fill water container with lukewarm water and descaling agent up to the  symbol and replace it" appears in the display, proceed as follows:

Make up the descaling solution

The descaling tablets supplied have been specially designed for Miele coffee machines. They can be purchased at www.miele-shop.com (depending on country) or from Miele.

You will need **1** descaling tablet to descale the machine.

Only use the Original Miele descaling tablets supplied with the machine. Other descaling tablets may damage the coffee machine and affect the taste of the coffee.

- Fill the water container to the  symbol with lukewarm water.

Descaling

- Place **1** descaling tablet in the water.

Ensure that you adhere to the mixing ratio for the descaling tablets. It is important that you do not fill the water container with less water than prescribed. The descaling programme will otherwise be cancelled prematurely.

- Replace the water container.
- Follow the further instructions given in the display.

When "Fill the water container with fresh tap water up to the descaling symbol  appears in the display:

- Carefully rinse the water container with clean water. Ensure that **no** descaling solution residue remains in the water container. Fill the water container to the  symbol with fresh tap water.

The descaling programme is finished at the end of the rinsing cycle and drinks can be made again.

To protect the machine and surrounding surfaces from damage, make sure you wipe up any spillages or splashes of descaling agent immediately.

The water container and the drip tray should be cleaned carefully after descaling in order to remove any descaling residue.

Descaling when not prompted by a message:

- Touch .
- Select "Maintenance" and touch OK.
- Select "Descale the appliance".

The descaling programme cannot be cancelled once you have touched OK. The programme has to be completed through to the end.

- Touch OK.

The descaling process will now start.

Most problems that occur during daily use can be easily corrected. With the help of the following guide, you will be able to find the causes of problems and rectify them.



 **Important!** Do not open the outer casing of the machine. Repairs must only be carried out by a Miele approved service technician. Repairs and other work by unqualified persons could be dangerous. The manufacturer cannot be held liable for unauthorised work.

If you can't remedy the problem yourself, please call Miele. Please note that a call-out charge will be applied to unnecessary service visits where the problem could have been rectified as described in these operating instructions.

Messages in the display



Error messages must be confirmed with "OK", otherwise the message can reappear in the display even though the problem has been remedied.

- Follow the instructions which appear in the display to remedy the problem.
- If the fault message appears in the display again, contact Miele.

Message	Possible cause and remedy
F1, F2 F80, F82	There is an internal fault. ■ Switch the machine off with the On/Off  sensor. Wait for 1 hour before switching it back on again.
F 41, F 42 F 74, F 77 F 235, F 236	There is an internal fault. ■ Switch the machine off with the On/Off  sensor. Wait for 2 minutes before switching it back on again.

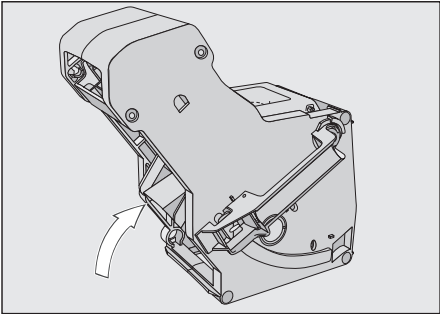

Problem solving guide

Message	Possible cause and remedy
"Too much ground coffee"	<p>There is too much ready ground coffee in the ground coffee chute.</p> <p>If more than one level scoop of ground coffee is added to the coffee chute, the brew unit cannot process the coffee. The ground coffee will be directed into the waste container and the fault message will appear in the display.</p> <ul style="list-style-type: none">■ Switch the machine off with the On/Off  sensor.■ Remove and clean the brew unit (see "Cleaning and care – Brew unit").■ Remove the ground coffee inside the coffee machine, e.g. with a vacuum cleaner.■ Use the coffee scoop supplied to add ground coffee to the ground coffee chute. Add only one portion of ground coffee to the chute.



Message	Possible cause and remedy
F73 or "Check the brew unit"	<p>The brew unit cannot be positioned correctly.</p> <ul style="list-style-type: none">■ Switch the machine off with the On/Off  sensor.■ Remove and clean the brew unit (see "Cleaning and care – Brew unit").  <ul style="list-style-type: none">■ Push the coffee ejector of the brew unit into the correct position (see diagram).■ Do not fit the brew unit. Close the front of the machine and switch the machine on with the On/Off  sensor. <p>This will initialise the brew unit motor and put it back into the start position.</p> <ul style="list-style-type: none">■ When "Insert the brew unit" appears in the display, open the front of the machine and put the brew unit back in the machine. Then close the door.

Problem solving guide

Unusual performance of the coffee machine

Problem	Possible cause and remedy
The lighting remains off after the coffee machine has been switched on.	The lighting has been switched off. ■ Switch the lighting on (see "Settings - Lighting").
	The lamp is defective. ■ Call Miele Service.
The display remains dark after the coffee machine has been switched on using the On/Off  sensor.	The On/Off  was not touched for long enough. ■ Touch the On/Off  sensor for at least 3 seconds.
	The master switch is pointing to "0". ■ Set the master switch to the "I" position.
	The plug is not inserted in the socket correctly. ■ Insert the plug into the socket correctly.
	The main fuse has tripped because of a problem with the coffee machine, the electricity supply or another appliance. ■ Switch off at the wall socket and unplug it. ■ Contact a qualified electrician or Miele.
The coffee machine switches off suddenly.	The switch-off time programmed using the timer has been reached. ■ If required, you can select a new switch-off time (see "Settings - Timer").
	The plug is not inserted in the socket correctly. ■ Insert the plug into the socket correctly.
The coffee machine is switched on. The lighting switches off suddenly.	The machine will switch itself off automatically after approximately 7 minutes if it is not being used.

Problem solving guide

Problem	Possible cause and remedy
The sensors do not react to touch. The appliance cannot be operated.	<p>There is an internal fault.</p> <ul style="list-style-type: none"> ■ Disconnect the machine from the power supply by removing the plug from the socket.
The coffee machine does not switch itself on, although the "Switch on at" setting has been activated for the timer.	<p>The system lock has been activated.</p> <ul style="list-style-type: none"> ■ You need to deactivate the system lock (see "Settings - System lock").
	<p>The machine was not used after being switched on automatically three times in succession.</p> <ul style="list-style-type: none"> ■ Switch the machine on and dispense a drink.
The display is hard to see or not able to be read.	<p>The display brightness has been set too low.</p> <ul style="list-style-type: none"> ■ Change this setting (see "Settings - Display brightness").
"Fill and replace the water container" appears in the display even though the water container is full and in the machine.	<p>The water container is not in the correct position.</p> <ul style="list-style-type: none"> ■ Remove the water container and replace it.
	<p>The water container was not correctly filled and replaced for descaling.</p> <ul style="list-style-type: none"> ■ Fill the water container to the descaling symbol  and restart the descaling programme.
"Fill and replace the water container" appears after switching on even though the container is filled and fitted in the machine. The appliance does not rinse.	<p>The coffee machine needs descaling.</p> <ul style="list-style-type: none"> ■ Switch the machine off with the On/Off  sensor. Wait approx. 1 hour. ■ Then switch the machine on again. As soon as "Heating-up phase" appears in the display, touch  and select "Descal the appliance". ■ Descal the coffee machine.

Problem solving guide

Problem	Possible cause and remedy
Neither milk nor milk froth comes out of the central spout.	<p>The milk pipework is blocked.</p> <ul style="list-style-type: none"> ■ Clean the central spout, taking particular care to clean the cappuccinatore and milk pipes carefully with the cleaning brush.
"Empty the drip tray" appears in the display, even though the drip tray is empty.	<p>The drip tray is not positioned correctly in the machine.</p> <ul style="list-style-type: none"> ■ Push the drip tray in as far as it will go. ■ Make sure the holder for the drip tray cover is correctly located on the drip tray.
Drink preparation has been cancelled.	<p>If the water container becomes empty while a drink is being made, the message "Water container empty. Continue? Yes / No" will appear in the display after the water container has been refilled and put back in the machine. If you do not confirm this message with "Yes" within 5 minutes, preparation will be cancelled.</p>
The coffee machine does not rinse itself when turned on.	<p>This is not a fault.</p> <p>If the coffee machine still has an operating temperature higher than 60°C , rinsing will not take place.</p>
<p>The display lights up but the coffee machine does not heat up and no drinks are made.</p> <p>The coffee machine cannot be turned off with the On/Off sensor .</p>	<p>The demo setting of the coffee machine for showrooms or dealers has been activated.</p> <ul style="list-style-type: none"> ■ Deactivate the demo mode (see "Settings - Demo mode").
"Fill the bean container" appears in the display even though the bean container is full.	<p>This is not a fault.</p> <ul style="list-style-type: none"> ■ Confirm the message with OK.

Problem solving guide

Problem	Possible cause and remedy
Drink dispensing starts even though a sensor has not been touched.	Condensate may have built up on the control panel and accidentally started the process. ■ Wipe any condensate off with a soft cloth.
Milk is dripping or running out of the central spout even though no milk is being dispensed.	The level of milk in the milk flask is higher than the central spout. ■ Push the central spout up as far as it will go.
The descaling programme was started by mistake.	The descaling programme cannot be stopped once the OK sensor has been touched. Descaling must be continued through to completion. This is a safety precaution to make sure the machine is descaled correctly.
Loud noises are heard during the descaling programme.	This is not a fault. These noises occur when water is flushed through the machine at a high pressure.
The heating-up time is getting longer, the amount of water being dispensed is incorrect and the coffee machine is not performing properly.	The coffee machine needs descaling. ■ Descale the coffee machine (see "Descaling").

Problem solving guide

Problem	Possible cause and remedy
Coffee or Espresso is not flowing out of the central spout, or coffee is only being dispensed via one spout.	<p>The central spout has a blockage.</p> <ul style="list-style-type: none">■ Clean the coffee pipework (see "Cleaning and care - Rinsing the machine).■ If, having rinsed the machine, Espresso or coffee still cannot be dispensed or only flows out of one spout,■ Dismantle the central spout and clean all parts carefully (see "Cleaning and care - Central spout with integrated cappuccinatore").■ Make sure all parts are reassembled correctly.
After switching the machine a message appears prompting you to empty the drip tray and the waste container even though they are empty.	<p>This is not a fault.</p> <p>The drip tray and waste container was probably not emptied after making the last coffee, or the internal counter was not reset.</p> <ul style="list-style-type: none">■ Remove the drip tray and waste container from the machine and empty them.

Unsatisfactory results

Problem	Possible cause and remedy
The consistency of the milk froth is unsatisfactory.	The milk temperature is too high. Good milk froth can only be achieved when cold milk (below 13°C) is used. ■ Check the temperature of the milk.
	The milk pipework is blocked. ■ Clean the central spout with integrated cappuccinatore and the milk pipework with the cleaning brush.
The coffee grinder makes a louder noise than usual.	The coffee bean container has become empty during the grinding process. ■ Fill the container with fresh beans.
	There may be stones in amongst the coffee beans. ■ Switch the coffee machine off immediately. Call Miele.
Espresso or coffee flows into the cup too quickly.	The coffee is too coarsely ground. ■ Set the grinder to a finer setting (see "Setting the coffee grinder").
Espresso or coffee flows into the cup too slowly.	The coffee is too finely ground. ■ Set the grinder to a coarser setting (see "Setting the coffee grinder").
The coffee or espresso is not hot enough.	The cup has not been pre-heated.
	The brewing temperature has been set too low. ■ Set a higher brewing temperature (see "Brewing temperature").
	The filters in the brew unit are blocked. ■ Remove and clean the brew unit by hand (see "Cleaning and care – Brew unit"). ■ Degrease the brew unit (see "Cleaning and care - Brew unit").

Problem solving guide

Problem	Possible cause and remedy
The crema on the coffee or espresso is not as it should be.	The grinder setting is not correct. ■ Set the grinder to a finer or coarser setting (see "Setting the coffee grinder").
	The brewing temperature is too high for this type of coffee. ■ Set a lower brewing temperature (see "Brewing temperature").
	The coffee beans are stale. ■ Add fresh coffee beans to the coffee bean container.

Transporting the machine

If you are not going to use the coffee machine for an extended period of time, e.g. whilst on holiday, or if it needs to be moved, a number of procedures will need to be carried out to ensure its safety.



Please carry out the following:

- Empty and clean the coffee bean container
- Empty and clean the water container
- Evaporate the coffee machine
- Clean the drip tray and waste container
- Pack the machine securely

Evaporating the coffee machine

The coffee machine should be evaporated before it is stored for a long period of time or transported any distance - particularly at temperatures below freezing.

Evaporating the machine involves removing all traces of water from the system to prevent the risk of water and frost damage.

- Switch the machine off with the On/Off  sensor.
- Touch .
- Touch  twice.

The evaporation process starts, the coffee machine heats up and "Empty the system" appears in the display.

- Follow the instructions given in the display.

 Caution. Danger of burning and scalding from hot steam coming out of the hot water spout.

The evaporation process is finished when "Process finished" appears in the display.

- Switch the machine off with the master switch and at the wall socket.
- Clean the drip tray and waste container.

The coffee machine is now ready to be packed.

Packing the machine

The coffee machine should only be packed when it is clean and dry. Residues of coffee grounds can cause scratches on surfaces. Coffee and milk residues or water can cause a build-up of bacteria.

Use the original packaging including polystyrene blocks to pack the coffee machine.

Also pack the operating instructions so that they are available when the coffee machine is next used.

After Sales / Guarantee

In the event of a fault which you cannot correct yourself, or if the machine is under guarantee please contact:

– your Miele Dealer

or

– Miele

Contact details for Miele are given at the end of this booklet. N.B. A call-out charge will be applied to service visits where the problem could have been resolved as described in these instructions.

When contacting Miele, please quote the model and serial number of your machine. This information is given on the data plate located behind the drip tray in the machine.

Guarantee

Guarantee: U.K.

In the U.K, the appliance is guaranteed for 2 years from the date of purchase. However, you must activate your cover by calling 0845 365 6640 or registering online at .

Guarantee: Other countries

For information on the appliance guarantee specific to your country please contact Miele. See end of this booklet for contact details.

If the default settings for "Eco mode" or the "Timer" have been altered, energy consumption will increase.

The message "This setting uses more energy" will appear in the display.

Pre-heating cups with hot water

If you only want to pre-heat your cups occasionally, you can switch the cup heating surface off.

You can then use hot water from the cappuccinatore to pre-heat the cups.

Switch the machine off with the master switch and at the wall socket.

If the coffee machine is not going to be used for a longer period of time, e.g. whilst on holiday, switch it off with the master switch and at the wall socket.

Electrical connection

All electrical work should be carried out by a suitably qualified and competent person only, in strict accordance with current national and local safety regulations (BS 7671 in the UK).

Installation, repairs and other work by unqualified persons could be dangerous. The manufacturer cannot be held liable for unauthorised work.

Ensure power is not supplied to the machine until after installation work has been carried out.

The voltage and connected load are given on the data plate located on the appliance behind the drip tray. Please ensure these match the household mains supply. The fuse rating is quoted on the plug.

The machine is supplied with a mains cable with moulded plug for connection to a 50 Hz, 220-240 V mains supply.

Connection should be made via a fused plug and suitable switched socket which is easily accessible after installation.

Do not connect via an extension lead or an adapter. These do not guarantee the safety of the machine (e.g. danger of overheating).

For extra safety it is advisable to protect the machine with a suitable residual current device (RCD). Contact a qualified electrician for advice.

If the socket is not accessible after installation (depending on country) an additional means of disconnection must be provided for all poles.

Do not connect the machine to an inverter such as those used with an autonomous energy source e.g. **Solar power**.

When switched on peak loads in the system can cause the safety switch off mechanism to be triggered. This can damage the electronic unit.

The machine must not be used with so-called Energy saving devices either. These reduce the amount of energy supplied to the machine causing it to overheat.

WARNING: THIS APPLIANCE MUST BE EARTHED

Non-rewireable plugs BS 1363

The fuse cover must be refitted when changing the fuse, and if the fuse cover is lost, the plug must not be used until a suitable replacement is obtained. The colour of the correct replacement cover is that of the coloured insert in the base of the plug, or the colour that is embossed in words on the base of the plug (as applicable to the design of plug fitted).

Replacement fuses should be ASTA approved to BS 1362 and have the correct rating. Replacement fuses and fuse covers may be purchased from your local electrical supplier.

Tip: If the mains connection cable is too long, push it up through the opening at the back of the machine.

Please observe the following installation instructions:

Danger of overheating.
Please ensure that there is adequate ventilation around the machine.
Do not cover the machine with tea towels or similar objects whilst it is in use.

Danger of overheating.
If the coffee machine is installed behind a kitchen furniture door, it may only be used with the furniture door open. Do not close the furniture door while the coffee machine is in use.

- The location of the machine must be dry and well ventilated.
- The ambient temperature of the room in which the machine is used must be between +10 °C and +38 °C.
- The machine must be set up on a level surface. The surface must be water resistant.

If the machine is installed in a niche, the niche must provide the following minimum dimensions:

Height	508 mm
Width	450 mm
Depth	555 mm

When setting up the machine: make sure that the front of the machine can be fully opened so that the brew unit can be removed with ease when required.

- The machine must be set up in the niche such that it sits flush with the front edge of the niche.

Appliance dimensions

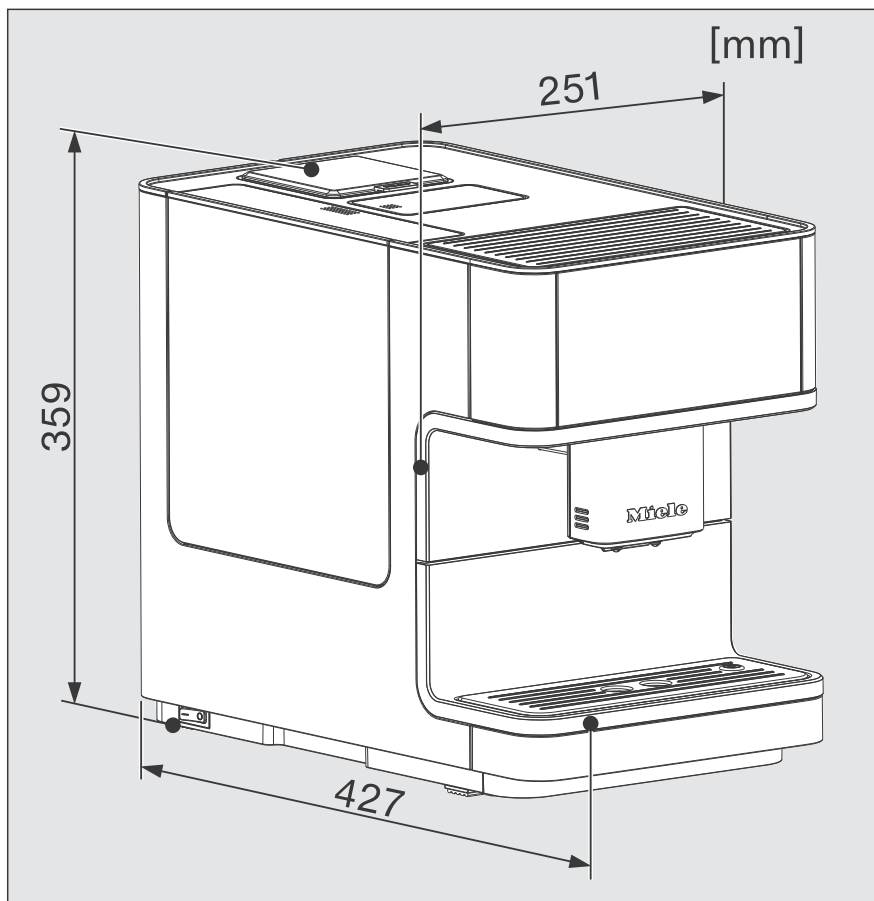

Technical data

Current draw in standby mode (default setting)	< 0.5 Watt
Pump pressure:	max. 15 bar
Through-flow heater:	1 stainless steel thermo block
Appliance dimensions (W x H x D):	251 x 359 x 427 mm
Net weight	9,9 kg
Connection cable length:	140 cm
Water container capacity:	1,8 l
Bean container capacity:	300 g
Stainless steel milk flask capacity:	0.5 l
Waste container capacity:	max. 10 portions of coffee grounds
Central spout:	Height adjustable from 80-140 mm
Grinder:	Stainless steel mill
Grinder setting:	5 settings
Ground coffee amount:	max 12 g

United Kingdom

Miele Co. Ltd.
Fairacres, Marcham Road
Abingdon, Oxon, OX14 1TW
Tel: 0845 365 0555
Customer Contact Centre Tel: 0845 365 6600
E-mail: info@miele.co.uk
Internet: www.miele.co.uk

Australia

Miele Australia Pty. Ltd.
ABN 96 005 635 398
1 Gilbert Park Drive, Knoxfield, VIC 3180
Tel: 1300 464 353, Fax: (03) 9764 7149
Internet: www.miele.com.au

China

Miele (Shanghai) Trading Ltd.
1-3 Floor, No. 82 Shi Men Yi Road
Jing' an District
200040 Shanghai, PRC
Tel: +86 21 6157 3500, Fax: +86 21 6157 3511
E-mail: info@miele.cn, Internet: www.miele.cn

Miele (Hong Kong) Limited

41/F - 4101, Manhattan Place
23 Wang Tai Road
Kowloon Bay, Hong Kong
Tel: (852) 2610 1331, Fax: (852)2610 1013
Email: mielehk@miele.com.hk

India

Miele India Pvt. Ltd.
Ground Floor, Copia Corporate Suites
Plot No. 9, Jasola
New Delhi - 110025
Tel: 011-46 900 000, Fax: 011-46 900 001
E-mail: customercare@miele.in, Internet: www.miele.in

Ireland

Miele Ireland Ltd.
2024 Bianconi Avenue
Citywest Business Campus, Dublin 24
Tel: (01) 461 07 10, Fax: (01) 461 07 97
E-Mail: info@miele.ie, Internet: www.miele.ie

Manufacturer: Miele & Cie. KG

Carl-Miele-Straße 29, 33332 Gütersloh, Germany

Miele

Malaysia

Miele Sdn Bhd
Suite 12-2, Level 12
Menara Sapura Kencana Petroleum
Solaris Dutamas No. 1, Jalan Dutamas 1
50480 Kuala Lumpur, Malaysia
Phone: +603-6209-0288
Fax: +603-6205-3768

New Zealand

Miele New Zealand Limited
8 College Hill
Freemans Bay, Auckland 1011, NZ
Tel: 0800 464 353, Fax: +64 9378 0146
Internet: www.miele.co.nz

Singapore

Miele Southeast Asia
Miele Pte. Ltd.
163 Penang Road
04 - 02/03 Winsland House II
Singapore 238463
Tel: +65 6735 1191, Fax: +65 6735 1161
E-Mail: infosea@miele.com.sg
Internet: www.miele.sg

South Africa

Miele (Pty) Ltd
63 Peter Place, Bryanston 2194
P.O. Box 69434, Bryanston 2021
Tel: (011) 875 9000, Fax: (011) 875 9035
E-mail: info@miele.co.za
Internet: www.miele.co.za

United Arab Emirates

Miele Appliances Ltd.
P.O. Box 11 47 82
Gold & Diamond Park
Sheikh Zayed Road
Building 6 / Offices Nos. 6-214 to 6-220
Dubai
Tel: +971-4-341 84 44
Fax: +971-4-341 88 52
E-Mail: info@miele.ae
Internet: www.miele.ae

CM 6300



en - GB

M.-Nr. 09 732 150 / 03

Free Manuals Download Website

<http://myh66.com>

<http://usermanuals.us>

<http://www.somanuals.com>

<http://www.4manuals.cc>

<http://www.manual-lib.com>

<http://www.404manual.com>

<http://www.luxmanual.com>

<http://aubethermostatmanual.com>

Golf course search by state

<http://golfingnear.com>

Email search by domain

<http://emailbydomain.com>

Auto manuals search

<http://auto.somanuals.com>

TV manuals search

<http://tv.somanuals.com>