

Miele

Operating and Installation instructions



Pyrolytic ovens H 4890 BP2

en - GB

To avoid the risk of accidents or damage to the appliance, it is **essential** to read these instructions before it is installed and used for the first time.

M.-Nr. 07 077 710

Contents

Description of the appliance	4
Appliance overview	4
Control panel	5
Features	6
Accessories	7
Caring for the environment	10
Warning and Safety instructions	11
Controls	16
Sensors	16
Display	16
Main menu and submenus	17
Before using for the first time	18
To set the timer	20
Using the oven	21
Selecting a function	21
Adjusting the oven temperature	21
Preheating	21
Duration	22
Duration	22
Start time	22
End time	23
Cancelling a process	23
Turning off the oven	23
At the end of cooking:	23
BAKE	24
Baking tips	24
ROAST	28
Roasting tips	29
Using the roast probe	30
MASTER CHEF	32
GRILL	34
Tips on grilling	34
FAVOURITES	37
SABBATH	38
DRYING	39
PROVE DOUGH	40
DEFROST	41

Settings	42
Language	42
Clock	42
Recommended Temperature	43
Lighting	44
Temperature °C / °F	44
Buzzer tones	44
Display	45
Factory default	45
System lock	46
Cleaning and care	47
Appliance front	47
Accessories	48
Grill pan, anti-splash tray and racks	48
Runners	48
Roasting filter	48
Roast probe	48
Rotisserie	48
PerfectClean	49
Oven interior	51
Pyrolytic cleaning of the oven interior	51
To remove the oven door	54
To refit the door	55
To remove the runners	55
Lowering the upper heating element	56
Problem solving guide	57
After sales service	61
Extra accessories	62
Electrical connection	63
Installing the oven	64

Description of the appliance

Appliance overview

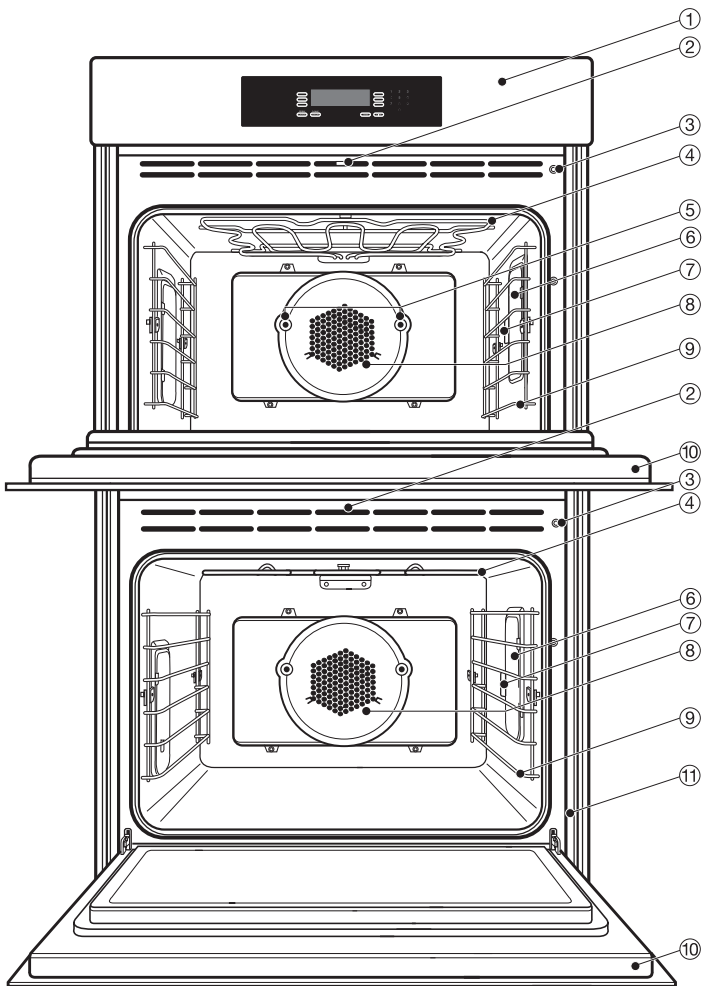

- ① Control panel
- ② Door lock for pyrolytic operation
- ③ Door contact switch
- ④ Heating element for top heat and grilling with roof liner
- ⑤ Rotisserie motors
- ⑥ Light
- ⑦ Connection socket for the roast probe
- ⑧ Air inlet for fan
- ⑨ Side runners with 6 shelf levels
- ⑩ Oven door
- ⑪ Data plate

Description of the appliance

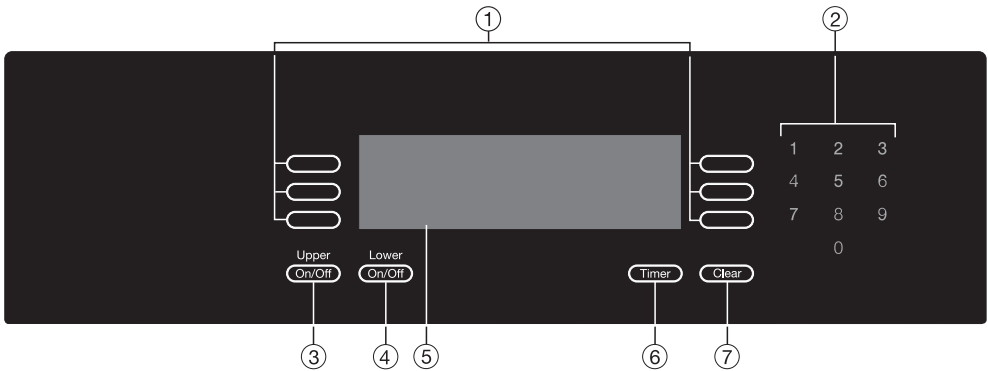

Control panel

- ① Sensors for selecting menu options in the display
- ② Context sensitive numerical keypad
- ③ "On/Off" sensor for upper oven
- ④ "On/Off" sensor for lower oven
- ⑤ Display
- ⑥ "Timer" sensor
- ⑦ "Clear" sensor

See "Controls" for more details.

Description of the appliance

Features

Electronic controls

In addition to operating the various cooking programmes to bake, roast and grill the electronic controls also offer the following features:

- Clock display
- Minute minder
- Timer to automatically switch cooking programmes off, or on and off with automatic use made of residual heat
- Favorites
- Master Chef automatic programmes
- Settings can be customised.

Safety features

You can activate a **system lock**, to prevent the appliance being used unintentionally. See "Settings - System lock" for details.

Safety shut-off is triggered automatically if the oven is operated for an unusually long period of time. The period of time will depend on the particular oven function being used. The oven will switch off automatically and "Fault 55" will appear in the display. The oven can be used again immediately after switching it off and back on.

Cooling system

As soon as the oven is switched on, a cooling fan is automatically engaged. The cooling fan mixes hot air from the oven cavity with cool room air before venting it out into the kitchen through vents located between the appliance door and the control panel.

The cooling fan will continue to run for a while after the oven has been switched off to prevent any humidity building up in the oven, on the control panel or on the oven housing unit.

When the temperature in the oven has fallen sufficiently, the cooling fan will switch off automatically.

Pyrolytic self-cleaning programme

The oven interior can be kept clean by using the Pyrolytic cleaning programme.

This programme heats the oven interior up to 460 °C. Any residual soiling is broken down and reduced to ash by the high temperatures.

For safety reasons the door is locked as soon as a pyrolytic programme is started.

The pyrolytic programme duration will vary depending on the level of soiling.

For safety reasons the door will remain locked until the temperature in the oven cavity has dropped below 280 °C.

See "Cleaning and care" for more information.

Description of the appliance

PerfectClean treated surfaces

The following surfaces are all treated with PerfectClean enamelling:

- Grill pan
- Anti-splash tray
- Rack

PerfectClean enamelled surfaces have very good anti-stick properties and are much easier to keep clean than conventional enamel, if cleaned regularly.

See "Cleaning and care" for more information.

Door contact switch

If the door is opened during operation, the door contact switch automatically switches off the heating elements, and the fan if a "Fan" setting is being used.

This helps reduce the amount of heat lost from the oven cavity, e.g. when checking food.

Accessories

The following accessories are supplied with this oven.

These and other accessories are also available to order from the Miele Spare Parts Department, your Miele Dealer or via the Internet (depending on country). See "Extra accessories" further on in this booklet for more details.

Racks

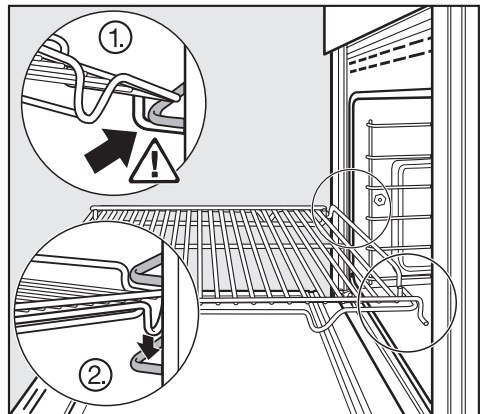

The racks are fitted with non-tip safety notches which prevent them being pulled right out when they only need to be partially pulled out.

When pushing the racks back in, always ensure that the safety notches are at the rear of the oven (see illustration).

The racks can then only be taken out of the oven by raising them upwards and then pulling them out.

Description of the appliance

Grill pan

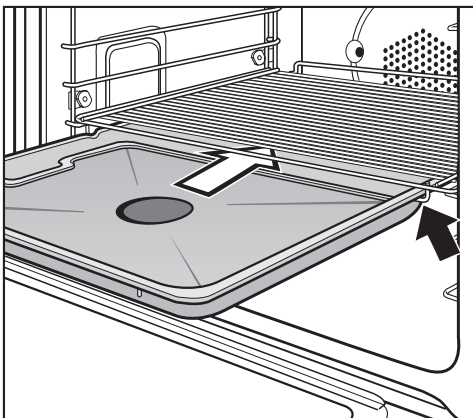

The grill pan is ideal for catching drippings from meat or poultry roasted or grilled directly on the rack.

Slide the roasting pan onto the rail below the wire rack. See illustration.

It can also be used as a baking tray.

Anti-splash tray

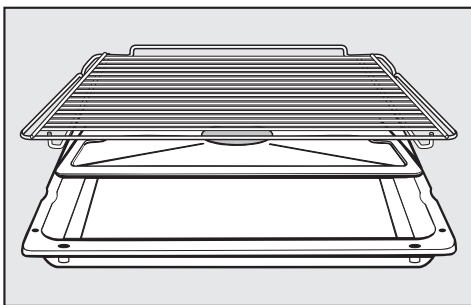

The anti-splash tray should be placed in the grill pan when grilling or roasting. The juices from the food being cooked collect under the anti-splash tray. This prevents them from spitting and making the oven dirty. The juices can then be used for making gravy and sauces.

Roasting filter

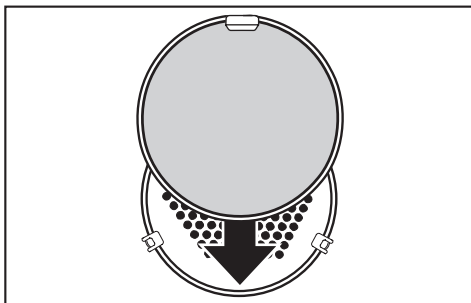

The roasting filter must be fitted in front of the fan when cooking anything fatty, or where food is likely to splatter, e.g. when open roasting or grilling meat.

The droplets of fat caught up in the circulating air are deposited on the roasting filter. This helps to keep the oven and the area behind the interior back panel cleaner.

Do not use the roasting filter when baking. This would increase the times needed for baking and give uneven browning results.

Description of the appliance

Roast probe

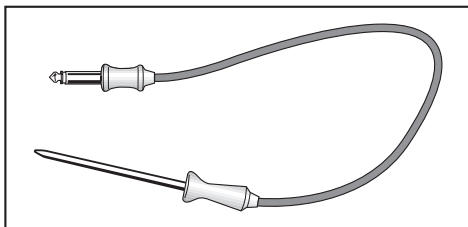

The roast probe enables the roasting process to be monitored simply and reliably.

Slide opener

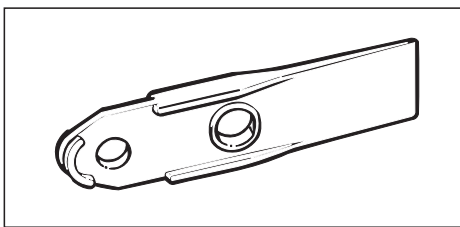

Use the slide opener for lifting off the light cover.

Rotisserie

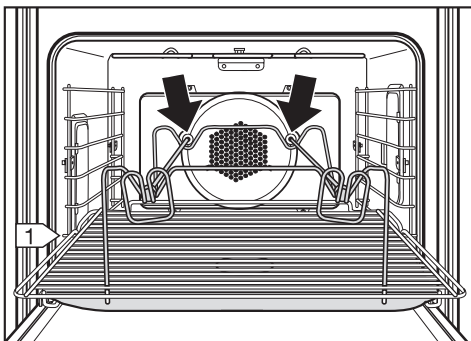

For grilling thicker items such as stuffed meat, poultry and kebabs.

The rotisserie fits into the grill pan for grilling or roasting. The grill pan goes into the first runner level and this automatically engages the rotisserie. The grill motor will then start up and turn the rotisserie. Food is grilled evenly on all sides as it rotates.

Caring for the environment

Disposal of the packing material

The transport and protective packing has been selected from materials which are environmentally friendly for disposal and can normally be recycled.

Ensure that any plastic wrappings, bags etc. are disposed of safely and kept out of the reach of babies and young children. Danger of suffocation!

Rather than just throwing these materials away, please ensure they are offered for recycling.

Disposal of your old appliance

Electrical and electronic appliances often contain materials which, if handled or disposed of incorrectly, could be potentially hazardous to human health and to the environment. They are, however, essential for the correct functioning of your appliance. Please do not therefore dispose of it with your household waste.

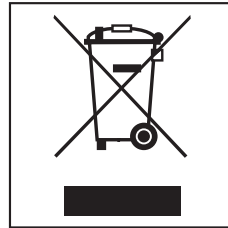

Please dispose of it at your local community waste collection / recycling centre and ensure that it presents no danger to children while being stored for disposal.

It should be unplugged or disconnected from the mains electricity supply by a competent person.

Warning and Safety instructions

This appliance complies with all relevant legal safety requirements. Improper use of the appliance can, however, present a risk of both personal injury and material damage.

To avoid the risk of accidents and damage to the appliance, please read these operating instructions carefully before installation and before using it for the first time. They contain important notes on installation, safety, operation and care of the appliance.

Keep these instructions in a safe place and pass them on to any future user.

Correct usage

► This appliance is intended for domestic use to cook food, and in particular to bake, roast, defrost, cook, dry fruit etc, and to grill.

Any other usage is at the owner's risk and could be dangerous. The manufacturer cannot be held liable for damage caused by incorrect or improper use of the appliance.

► This appliance is not intended for use by persons (including children) with reduced physical, sensory or mental capabilities, or lack of experience and knowledge, unless they have been given supervision or instruction concerning use of the appliance by a person responsible for their safety.

Safety with children

► This appliance is not a toy! To avoid the risk of injury, keep children well away from it and do not let them play with it or use the controls. They will not understand the potential dangers posed by it.

► Great care should be taken to ensure that small children do not touch the appliance when it is being used. The external parts of the oven such as the door glass, handle vent and control panel can become quite hot.

► Children should not be left alone or unattended in an area where an oven is in use. They should never be allowed to sit or stand on any part of the oven or play with it.

Do not store items of interest to children in cabinets above an oven. Children climbing on the oven to reach these items could be seriously injured.

► Young children must be supervised whilst you are using the oven.

► Older children may use the oven if they have been taught how to use it safely and understand the dangers of misuse.

Warning and Safety instructions

Technical safety

► Before connecting the appliance to the mains supply, make sure that the voltage and frequency correspond to the rating on the data plate, otherwise the appliance could be damaged. Consult a competent person if in doubt.

► The electrical safety of this appliance can only be guaranteed when continuity is complete between it and an effective earthing system which complies with current local and national safety regulations. It is most important that this basic safety requirement is present and regularly tested, and where there is any doubt the household wiring system should be inspected by a qualified electrician.

The manufacturer cannot be held liable for the consequences of an inadequate earthing system (e.g. electric shock).

► The appliance must be built in before operation to ensure that no electrical components are accessible.

► Never open the casing of the appliance. Tampering with electrical connections or components and mechanical parts is highly dangerous to the user and can cause operational faults.

► Installation, maintenance and repair work may only be carried out by a suitably qualified and competent person in accordance with national and local safety regulations. Repairs and other work by unqualified persons could be dangerous. The manufacturer cannot be held liable for unauthorised work.

► If the supply cord is damaged, it must be replaced by a Miele approved service technician in order to avoid a hazard.

► During installation, maintenance and repair work, the appliance must be disconnected from the mains electricity supply. The appliance is only completely isolated from the electricity supply when:

- the mains fuse is withdrawn,
- or the screw-out fuse is removed (in countries where this is applicable),
- or it is switched off at the isolator.

Ensure that current is not supplied to the appliance until after maintenance or repair work has been carried out.

► Do not connect the appliance to the mains electricity supply by an extension lead.

Extension leads do not guarantee the required safety of the appliance (e.g. danger of overheating).

► This equipment may only be used in mobile installations such as ships, caravans, aircraft etc. if a risk assessment of the installation has been carried out by a suitably qualified engineer.

Warning and Safety instructions

Use

Caution, danger of burning.
High temperatures are produced by the oven.

► Use oven gloves when placing food in the oven, turning or removing it. When working with "Conventional" heating or when grilling, the element in the roof of the oven and the roof liner become very hot, and there is a danger of being burnt.

► The oven door gets much hotter during pyrolytic operation than during normal use.

Make sure children cannot touch the oven whilst a pyrolytic programme is running. Danger of burning.

► Remove all accessories as well as the runners and any extra accessories from the oven interior before starting the pyrolytic cleaning process. The high temperatures needed for pyrolysis will damage the accessories and cause irreparable damage.

► Only use the Miele roast probe supplied with this appliance. If a replacement is necessary it can be obtained from the Miele Spare Parts dept. or your Miele dealer.

► When not in use do not leave the roast probe in the oven, especially when grilling. High temperatures would damage it.

► Do not use plastic containers. These melt at high temperatures and could damage the oven.

► Do not heat up unopened tins or jars of food in the oven, as pressure can build up and they may explode. This could result in injury or damage.

► Do not push pots and pans around on the oven floor as this could damage the surface.

► Do not lean or sit on an open oven door, or place heavy items on it. This could damage the appliance. Take care in the region of the hinges. The oven door can support a maximum load of 15 kg.

► Make sure that nothing gets trapped between the door and the oven.

► Cover any food which is left in the oven to be kept hot. This avoids the food drying out. It also prevents steam condensing and possibly leading to moisture damage in the oven.

Warning and Safety instructions

▶ If you wish to leave food in the oven after cooking, e.g. to take advantage of the residual heat, do not turn the oven off. Simply select the lowest temperature and leave the function at the position set.

Do not switch the appliance off until the food has been removed.

Otherwise, moisture in the oven could lead to condensation forming on the control panel and surrounding kitchen furniture and drops of moisture collecting under the worktop.

Condensation can:

- damage the housing unit / worktop.
- lead to moisture damage in the oven.

▶ Bake larger deep-frozen items such as pizzas on baking paper on the rack itself or in the pizza pan (see "Extra accessories"). Placing them on the baking tray or in the grill pan can cause the metal to distort. This distortion would increase with subsequent use. Deep frozen foods such as oven chips or potato croquettes can be cooked on the baking tray or grill pan.

▶ Never add water to food on a hot baking tray or grill pan or directly onto food in a hot oven. The steam created could cause serious burns or scalding and the sudden change in temperature can damage the enamel.

▶ Never line the floor of the oven with aluminium foil when using Conventional top and bottom heat or Intensive bake. Do not place a dish, tin, baking tray or grill pan on the floor of the oven.

If using a grill pan made by a different manufacturer make sure that there is a gap of at least 6 cm between the bottom of the pan and the floor of the oven.

If these instructions are not observed the bottom heat will be blocked. This can cause permanent damage to the floor of the oven.

▶ Protective aluminium foil panels are available in retail outlets which are supposed to protect the oven cavity from soiling and reduce the need for cleaning. If used, cooking and baking times will increase considerably. They can also cause damage to the appliance (e.g. by blocking the heat).

General notes

▶ Never leave the appliance unattended when cooking with oils and fats as these are a fire hazard if allowed to overheat.

▶ Do not use the oven to heat up the room. Due to the high temperatures radiated, objects left near the oven or hob could catch fire.

Warning and Safety instructions

▶ Always ensure that food is sufficiently cooked or reheated. Many factors will affect the overall cooking time, including the size and amount of food, its temperature, changes to the recipe and the shape and size of cooking container. Some foods may contain micro organisms which are only destroyed by thorough cooking at temperatures over 70°C for a minimum of 10 minutes. Therefore when cooking or reheating foods, e.g. poultry, it is particularly important that food is fully cooked through. If in doubt select a longer cooking or reheating time. It is important that the heat is allowed to spread evenly throughout the food being cooked. This can be achieved by stirring and/or turning the food during cooking.

▶ When using kitchen appliances connected to sockets near the oven, ensure that the cable cannot get trapped in a hot oven door, which could melt the cable insulation. Danger of electric shock.

▶ Never use a steam cleaner to clean this appliance. The steam could reach electrical components and cause a short circuit.

▶ If using alcohol in your recipes high temperatures can cause the alcohol to vaporise, and under adverse circumstances the alcohol can catch light on the hot heating elements. Alcohol should be burnt off before the dish is placed in the oven to avoid this danger.

▶ In countries which may be subject to infestation by cockroaches or other vermin, pay particular attention to keeping the appliance and its surroundings in a clean condition at all times.

Any damage which might be caused by cockroaches or other vermin will not be covered by the appliance guarantee.

Disposal of your old appliance

▶ Before throwing an old appliance away it must first be made unusable. Switch off and disconnect it from the power supply, cut off the cable directly behind the appliance and render any plug useless. This should be done by a competent person.

The manufacturer cannot be held liable for damage caused by non-compliance with these Warning and Safety instructions.



Controls

Sensors

The electronic sensors around the display react to touch.

An audible tone will sound each time a sensor is pressed. You can deactivate this, if wished (see "Settings  - Keypad tone")



These sensors are used to call up options marked with  or  in the display.

"On/Off" (Upper)

Touching this sensor switches the top oven on and off.

"On/Off" (Lower)

Touching this sensor switches the bottom oven on and off.

"Timer"

This sensor is used to enter a time for the minute minder.

"Clear"

This sensor is used to cancel an entry.

Display

When the **oven is switched on**, the **Main menu** will appear:



Additional functions are displayed by touching the "Cont." control.

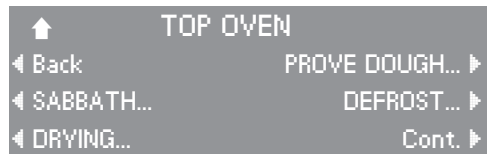

The previous display can be recalled by touching the "Back" control.

Dots after a function indicate a submenu.

The submenu will appear when the function is selected.

When the **lower oven is switched on**, its **Main menu** will also appear:

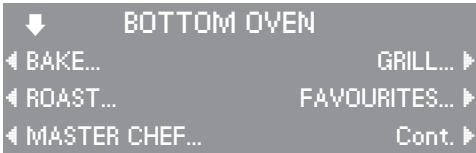

When both ovens are in use, the display will split to indicate the status of each oven.



The "↑" arrow points to the settings of the upper oven, the "↓" arrow to the lower oven settings.

Main menu and submenus

BAKE	BAKE FAN PLUS CONVENTIONAL BROWNING INTENSIVE BAKE
ROAST	AUTO ROAST FAN ROAST CONVENTIONAL ROAST
MASTER CHEF	see Chapter "MASTER CHEF"
GRILL	FULL GRILL GRILL (HALF) FAN GRILL ROTISSERIE
FAVOURITES	
SABBATH	BAKE CONVENTIONAL
DRYING	
PROVE DOUGH	
DEFROST	
PYROLYTIC	
SETTINGS 	LANGUAGE CLOCK REC. TEMPERATURE LIGHTING TEMPERATURE BUZZER TONES DISPLAY FACTORY DEFAULT SYSTEM LOCK

Before using for the first time

The oven will switch on automatically when it is connected to the electricity supply.

Set the time

"Enter time: hh:mm" will appear in the display once the oven is connected to electricity.

- Set the current time using the keypad.

Save the time by touching the "OK" control.

The preset format is for a 12 hour clock.

You can alter the time format, if wished (see "Settings  - Clock").

Cleaning and heating up for the first time

- Before use, please remove
- any stickers from the floor of the oven, baking trays, grill pan etc.
 - the protective cork discs from the sides of the oven
 - any protective foil from the oven front.

Before using the oven for the first time

- take **all accessories** out of the oven and wash them.

See "Cleaning and care" for more information.

- then **heat both ovens up once with nothing in them**. New ovens have a slight smell on first use and this will dissipate the smells before you use it to cook any food.

Before using for the first time

- Press both "On/Off" sensors.

The appliance will switch on and the main menu will appear in the display.



- Select "BAKE".

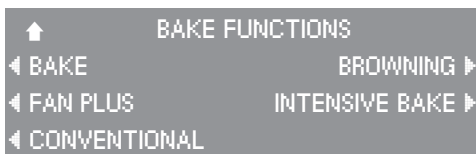

- Select "FAN PLUS".

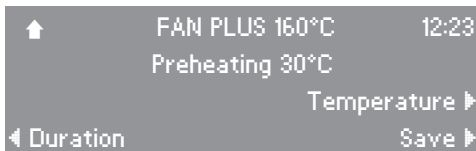

The recommended temperature of 160 °C will appear highlighted.

- Select "Temperature" and then use the numerical keypad to increase the temperature to 260 °C (the highest temperature).

The oven will start heating up as soon as this entry has been accepted.

Heat the empty oven up for at least an hour.
Please ensure that the kitchen is well ventilated during this operation.
Close doors to other rooms to prevent the smell spreading throughout the house.

- Set the timer to run the oven for this time by touching the "Duration" control.
- Select "Duration" and set the duration using the keypad.

The oven will start heating up as soon as this entry has been accepted.

- Leave the oven to cool down to room temperature.
- Then wipe out the oven cavity with a solution of hot water and a mild detergent and then dry it thoroughly with a clean cloth.

Do not close the oven door until the oven interior is dry.

To set the timer

The timer can be used to time any activity in the kitchen, e.g. boiling eggs.

Two timers (Timer 1 and 2) can be selected simultaneously.

You can enter a time up to a maximum of 59 minutes and 59 seconds.

You can set the timer at the same time as another timed programme, e.g. as a reminder to stir a dish or add seasoning etc.

To set the timer

- Touch the "Timer" control.

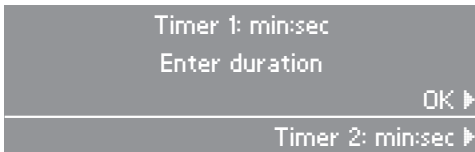

- Use the keypad to enter the required time in minutes and seconds.

The second timer can be set in the same way as the first.

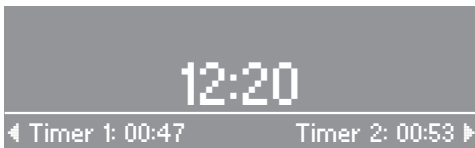

The count down of Timer 1 and 2 is shown in the lower area of the display.

At the end of the set time a buzzer will sound.

You can alter the buzzer tone, if wished (see "Settings" - Buzzer tones").

- Touch "Clear" to stop the buzzer.

To cancel the timer

- Touch the "Clear" control.



- Touch the control for the timer to be cancelled or to cancel both timers and any function that is running touch "ALL FUNCTIONS".

- Then touch "OK".

Selecting a function

- Touch the "On" control to activate the display.



- Touch the control next to the function you wish to select.

For example, touch the control next to the word "BAKE" to select this function.

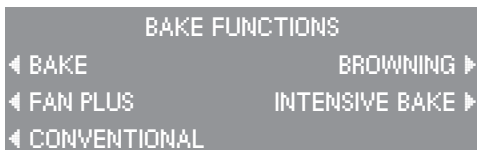

The "BAKE" function submenu will appear in the display.

- Touch the control next to the submenu function you wish to select.

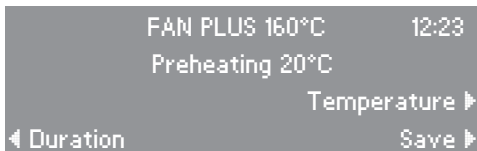

For example, touch the control left of "FAN PLUS".

The "FAN PLUS" function will appear in the display.

The default temperature of 160 °C will be displayed next to the function name.

Adjusting the oven temperature

This oven has been factory tested for the optimum operating temperature of each function. This temperature can be adjusted if needed.

- Touch the "Temperature" control.

The temperature will be highlighted in the display.

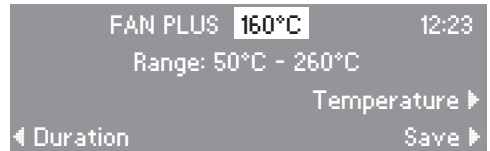

- Enter the new temperature using the keypad.

The oven will heat to the adjusted temperature.

Preheating

For proper cooking results, most recipes call for a preheated oven. After a temperature has been selected, the rising temperature can be viewed in the display.

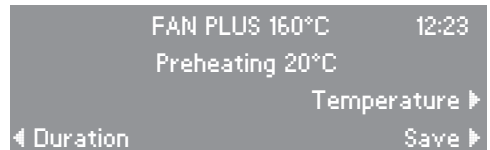

"Preheating" will show in the display until the oven has reached the selected temperature.

A tone will sound once the oven has finished preheating.

- Place the food in the oven once the temperature has been reached.

The oven should **not** be preheated when using "AUTO ROAST".

Using the oven

Duration

This function allows you to turn cooking processes automatically off or on and off.

Duration

By entering a cooking duration the oven will switch itself off automatically. The maximum duration which can be entered is 11 hours 59 minutes.

- Touch the "Duration" control.

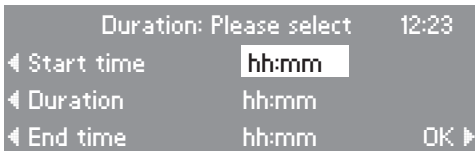

- Touch the "Duration" control again and enter the cooking time.
- Confirm the entries by touching the "OK" control or cancel by touching "Clear".

For example, enter "00:50" and the function will run for 50 minutes.

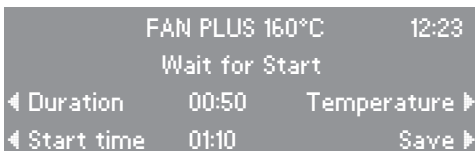

Start time

This feature allows you to delay the start of a function, from 1 minute to 23 hours 59 minutes, so that the cooking process begins at a specified time and finishes automatically.

- Touch the "Duration" control.
- Touch the "Start time" control and enter the start time.

For example, enter "01:10" and the oven will start cooking at 1:10.

- Touch the "Duration" control and enter the cooking time.

For example, enter "00:50" and the function will run for 50 minutes.

The "duration" must be entered for this feature to operate correctly.

- Confirm the entries by touching the "OK" control or cancel by touching "Clear".

The end time will automatically be calculated.

End time

The desired end time allows you to set the actual time you would like cooking to complete. This time is limited to 24 hours from the current time.

- Touch the "Duration" control.
- Touch the "End time" control and enter the desired end time.

For example, enter "02:15" and the oven will to finish cooking at 2:15.

- Touch the "Duration" control and enter the cooking time.

For example, "01:30" for 1 hour and 30 minutes.

If a duration time is entered, a delayed start time will automatically be calculated.

If no duration time is entered, the oven will calculate a duration based on the current time.

- Confirm the entry by touching the "OK" control or cancel by touching "Clear".

Cancelling a process

- Touch the "Clear" control.

The cooking process will be cancelled.

If the timer was set in addition to a cooking process time, touching "Clear" will show all options which can be cancelled

- Select the option you wish to cancel.

Turning off the oven

- Touch the "OFF" control.

The oven will turn off and the time of day will appear in the display.

At the end of cooking:

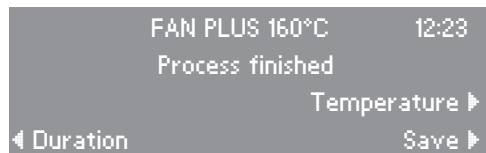

- a tone will sound,
- "Process finished" will appear in the display under the function name, and
- the oven will shut off automatically.

BAKE

Baking tips

Remember to remove the grease filter from the fan opening when baking pastries. If the filter is not removed, increase the baking time.

The grill pan does not need to be greased or covered with parchment paper. The PerfectClean enamel finish prevents spillovers from baking onto and into the surface. Baked food can be easily removed.

Use baking parchment only for dough with a high egg white content, i.e. for biscuit, meringue or macaroons.

BAKE

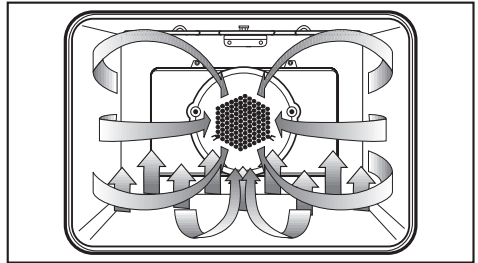

Default temperature 190 °C

The "BAKE" function works by heating food from below.

Use this function for:

- boxed cake mixes,
- baked apples,
- frozen dinners.

The recommended positions are the 2nd or 3rd runners from the bottom.

FAN PLUS

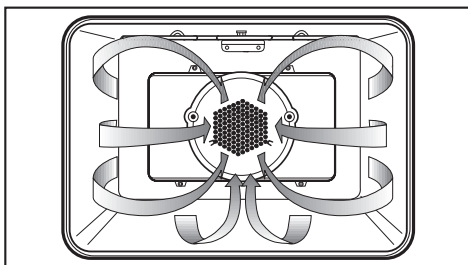

Default temperature 160 °C

This function actively circulates heated air throughout the oven cavity for a consistent baking temperature.

Use this function for:

- cookies, cakes,
- quick breads,
- yeast breads,
- cheesecakes,
- pies, quiche,
- baked potatoes,
- casseroles.

When using this function, several runner levels can be used at the same time.

The recommended positions are:

- 1 tray = 1st runner from the bottom
Exception: Place cookies on the 3rd runner from the bottom.
- 2 trays = 1st and 4th runners from the bottom
- 3 trays = 1st, 3rd and 5th runners from the bottom

When baking 3 trays of cookies or small cakes at the same time, remove the respective tray when the desired browning is reached.

As a general rule, the temperature of a recipe not designed for baking in a fan oven should be lowered by 15 °C.

BAKE

CONVENTIONAL

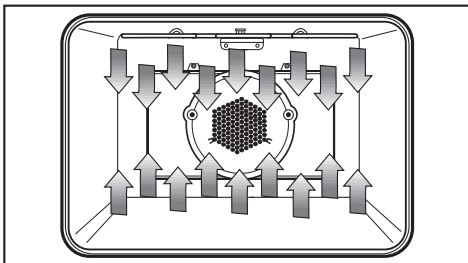

Default temperature 190 °C

The "CONVENTIONAL" function is a premium conventional baking mode. The oven heats with both the upper and lower heating elements without the convection fan.

Use this function for:

- souffles, meringues,
- angel food cakes,
- cream puffs,
- cookies, cakes,
- cheesecakes,
- pies, quiche,
- baked potatoes.

The recommended positions are the 1st or 2nd runners from the bottom.

BROWNING

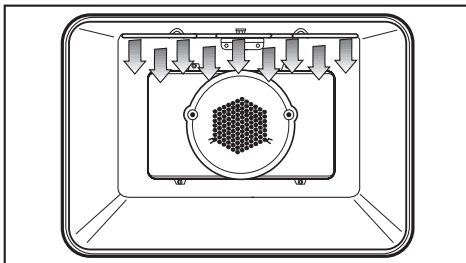

Default temperature 190 °C

In the "BROWNING" function, food is heated from above.

Use this function for:

- browning meringue,
- melting a cheese topping,
- caramelising a sugar topping as in crème brulee.

The recommended position is the 4th runner from the bottom.

INTENSIVE BAKE

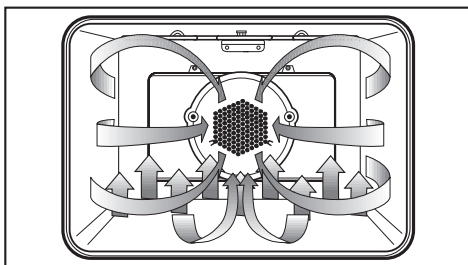

Default temperature 160 °C

The "INTENSIVE BAKE" function generates heat from the lower heating element. The oven's fan gently circulates the heated air to create a "brick oven" environment.

Use this function for:

- pizza,
- focaccia,
- stromboli.

Use the 1st runner from the bottom. Should the bottom of the food burn, raise the rack to a higher runner.

When using "INTENSIVE BAKE", recipe temperatures should be lowered by 15 °C.

Intensive is not recommended for roasting or shallow baking.

Do not bake on the oven floor.

ROAST

When roasting (all Roast functions), insert the grease filter in front of the fan opening.

AUTO ROAST

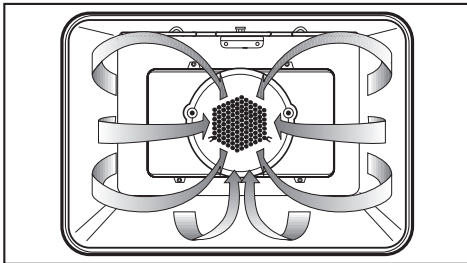

Default temperature 160 °C

This function heats the oven to a high temperature to sear the meat, retaining moisture and tenderness.

Once the oven cavity temperature has exceeded the set temperature, "Searing" will appear in the display. Once the meat is seared, the function returns to the selected temperature.

Use this function for:

- poultry (whole birds),
- roasts, e.g. prime rib, pork loin, beef tenderloin, leg of lamb, etc.

The recommended position is the 1st runner from the bottom.

The oven should not be preheated when using "AUTO ROAST".

FAN ROAST

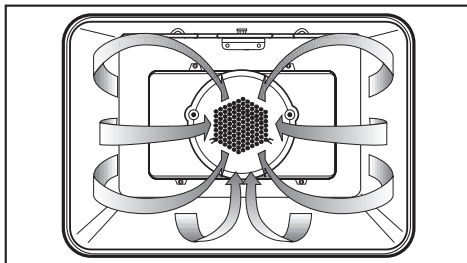

Default temperature 160 °C

This function uses the convection fan to actively circulate heated air throughout the oven

Use this function for:

- chicken pieces,
- small cuts of meat,
- fish,
- salmon, lobster tails,
- meat loaf.

The recommended position is the 1st runner from the bottom.

CONVENTIONAL ROAST

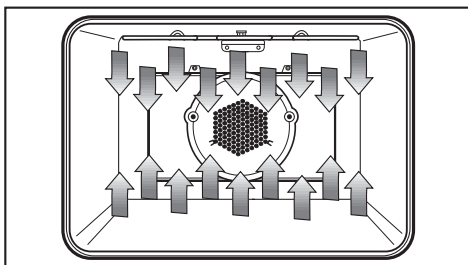

Default temperature 200 °C

"CONVENTIONAL ROAST" is a conventional roasting programme for traditional recipes.

Use this function for:

- pot roast,
- brisket,
- stew.

The recommended position is the 2nd runner from the bottom.

Roasting tips

- Always install the grease filter in the back of the oven before roasting.
- The larger the cut of meat to be roasted, the lower the temperature that should be used. The roasting process will take a little longer, but the meat will be cooked evenly and the outside will become crisp.
- Use the roast probe for accurate cooking temperatures and best results.

Roasting in a covered pot

When roasting in a covered pot, increase the recipe temperature by 20 °C.

Season the meat and place it in the pot. Add some butter, margarine or a little oil and about 1/2 cup of water when roasting a large piece of meat or roasting poultry with a high fat content.

Roasting on the rack

Use the rack with the roasting pan inserted below. Add a little oil to very lean meat or place a few strips of bacon on top to help retain moisture. Place a little water in the roasting pan below the meat to catch drippings.

Roasting poultry

For crispy skin, baste the poultry ten minutes before the end of cooking with salt water.

ROAST

Using the roast probe

The roast probe reliably monitors the roasting process. The tip of the probe continuously measures the core temperature of the meat.

When the selected core temperature is reached, the oven automatically shuts off.

The roast probe can be used with the following functions:

- AUTO ROAST
- FAN ROAST
- CONVENTIONAL ROAST
- FAN GRILL

Using the roast probe:

- Prepare the meat as usual (in a pot or on the rack).

Roasting bags or aluminum foil may be used, but only when left open at the end. Insert the probe into the meat through the opened end of the foil or bag.

- Insert the probe into the middle of the meat. Make sure that the probe does not touch any bones and is not located in a fatty portion of the meat. Improper insertion of the probe could shut the oven off too early.

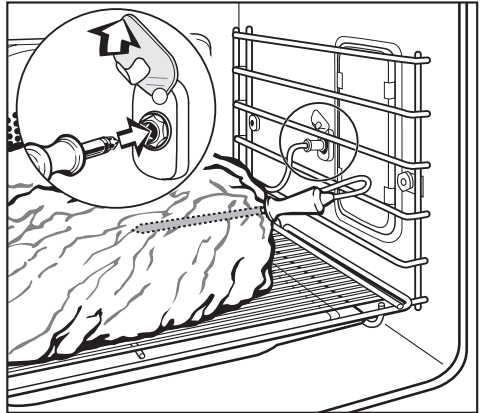

- Put the meat into the oven.
- Insert the short end of the roast probe into the socket on the right side of the oven so it clicks into place.

We do not advise using the roast probe with small poultry or fish. Because of the amount of bone and cavity space it is difficult to find a good place to insert the probe.

- Select a roasting function.

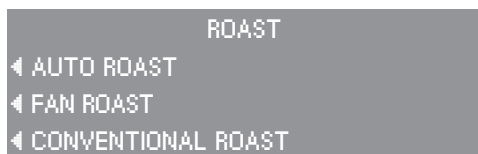

For example, "AUTO ROAST".

The default temperature and the Roast probe core temperature, once inserted, will show in the oven display.

To adjust the core temperature:



- Touch the control to the left of "Roast probe".



- Enter the required core temperature using the keypad.

The start of roasting can also be delayed at this time.



- Touch the "Start Time" control.

- Enter the required start time of the roasting process using the keypad.



At the end of cooking, when the selected core temperature has been reached, a tone will sound.

The tone can be cancelled by touching "Clear".

Please note:

When finished, cover the meat with aluminum foil and allow to stand for 10 minutes. During this time, the core temperature will rise 5 - 10 degrees.

If the temperature probe is left in the food at the end of the cooking process, the oven display will show the core temperature first increasing and then decreasing.

MASTER CHEF

When using the "MASTER CHEF" function to cook meat or poultry insert the grease filter in front of the fan opening.

The "MASTER CHEF" function contains an easy to use list of preset functions of commonly cooked foods such as pizza, chicken and french fries.

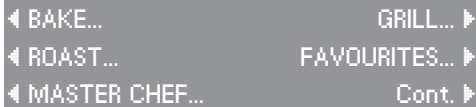

◀ BAKE... GRILL... ▶
◀ ROAST... FAVOURITES... ▶
◀ MASTER CHEF... Cont. ▶

- Touch the "MASTER CHEF" control to view the list of preset functions.

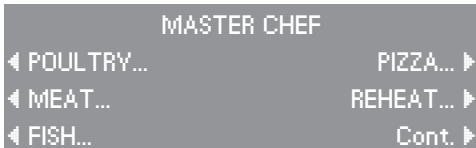

MASTER CHEF
◀ POULTRY... PIZZA... ▶
◀ MEAT... REHEAT... ▶
◀ FISH... Cont. ▶

- Touch the control of the function you wish to select.

For example, to cook a 5 kg turkey you would select "POULTRY".

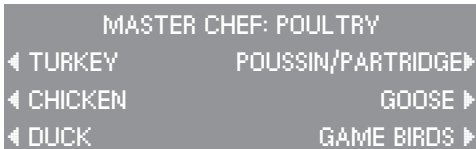

MASTER CHEF: POULTRY
◀ TURKEY POUSSIN/PARTRIDGE ▶
◀ CHICKEN GOOSE ▶
◀ DUCK GAME BIRDS ▶

- Touch the control to the left of "TURKEY".

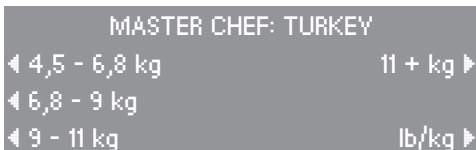

MASTER CHEF: TURKEY
◀ 4,5 - 6,8 kg 11 + kg ▶
◀ 6,8 - 9 kg ▶
◀ 9 - 11 kg lb/kg ▶

- Touch the control that corresponds to the weight of the turkey, "4.5 - 6.8 kg".

Turkey 4,5 - 6,8 kg

Estimated duration: 3:10

◀ Roast probe 80 °C Function ▶

◀ Start Time Save ▶

- Insert the roast probe into the turkey and into the roast probe socket, as prompted.
- The remaining cooking time can be monitored in the display.

To view the settings of a "MASTER CHEF" function, touch the control for "Function".

Tips for use

- To end a Master Chef programme prematurely, turn the oven off.
- If the food is not cooked to your liking after the programme has elapsed, set the oven to Fan Plus 160°C and cook or brown it for a few more minutes.
- After use let the oven cool to room temperature before using it again for a Master Chef programme.
- When cooking poultry like goose or turkey, set the weight of the unstuffed bird.
When cooking more than one bird at once, set the weight of the heavier one (not the total weight).
- During some programmes the oven must be preheated before placing the food into the oven. The respective info and time indication will show in the display.
- Master Chef programmes can be saved as "Favourites".

MASTER CHEF Functions

POULTRY

Turkey

4.5 - 6.8 kg
6.8 - 9 kg
9 - 11 kg
11 + kg

Chicken

Cordon Bleu
Whole: 0-2.3 kg
Whole: 2.3+ kg
Escalopes
Pieces

Duck

1.4 - 2.3 kg
2.3+ kg

Poussin/ Partridge

0.5 - 0.9 kg

Goose

2.3 - 4.5 kg
4.5 - 6.8 kg

Game birds

0 - 0.9 kg
0.9 - 1.8 kg

MEAT

Beef

Roast beef
Forerib
Braised beef
Steaks
London Broil

Pork

Loin Roast
Shoulder
Crown Roast
Cooked Ham
Cured Ham
Cutlets

Veal

Rolled Roast
Loin Roast
Forerib
Cutlets

Lamb

Shank
Rack
Half Shank
Fillet

FISH

Steak

Filletts
Whole
Lobster Tails
Paella
Prawns

PIZZA

Fresh
Frozen
Raising agent
Stromboli
Calzone

REHEAT

Pizza
Banquet Pan
Casserole

BAKED GOODS

Fruit Pie
Layer Cake
Cookies
Soufflé
Gateau
Muffins

POTATOES

Baked
Chips

If prompted to use the roast probe please ensure you insert it in sufficient meat, avoiding bone and cavity.

GRILL

Tips on grilling

- When grilling (all grill functions), always fit the grease filter in front of the fan opening.
- To ensure even cooking, it is best to grill foods of a similar thickness at the same time. Most items should be turned halfway through grilling.
- To determine how far through a thick piece of meat has been cooked, press down on its surface with a spoon.

If the surface presses down easily and with little resistance to the spoon, it is "rare".

If there is some resistance, it is "medium".

If there is great resistance, it is "well done".

FULL GRILL

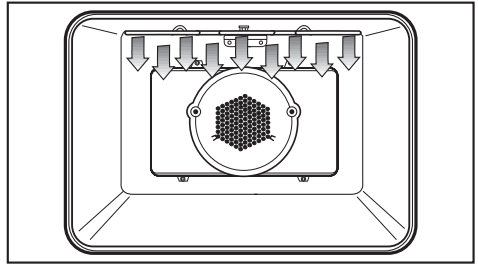

No default temperature (High)

The entire upper heating element is used for intense heating from above. This function gives excellent browning and searing results.

Use this function for:

- chops, ribs,
- large quantities of meat,
- browning large dishes.

The recommended position is the 4th runner from the bottom.

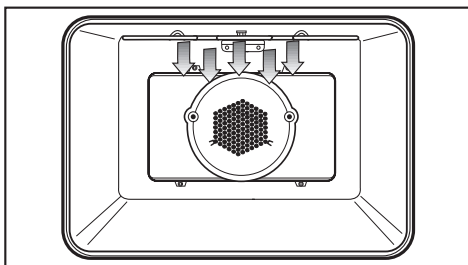
GRILL (HALF)

No default temperature (High)

Only the inner part of the upper heating element is used for a smaller area of intense heat from above. This function is excellent for grilling or searing small quantities.

Use this function for:

- chops, ribs,
- small quantities of meat,
- browning small dishes.

The recommended position is the 4th runner from the bottom.

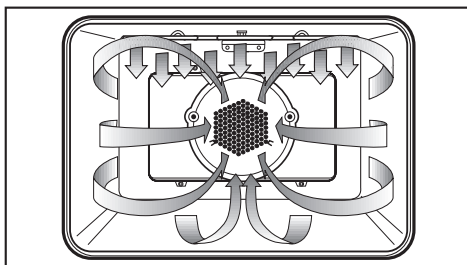
FAN GRILL

No default temperature (High)

Hot air from the upper heating element is distributed over the food by the fan. This enables a lower temperature than conventional broiling to be used.

Use this function for:

- thick pieces of meat,
- London broil.

The recommended position is the 3rd runner from the bottom.

Always insert the grease filter in front of the fan in the back of the oven when using this function.

The roast probe can be used in this function to monitor the meat's core temperature. Refer to "ROAST/ Using the roast probe" for more information.

GRILL

ROTISSERIE

This function is only available in the **upper oven**.

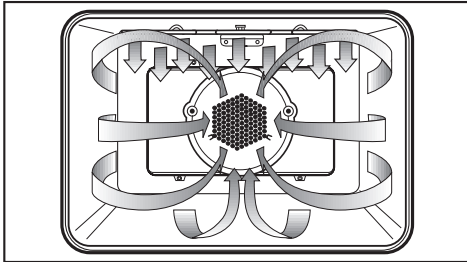

No default temperature

The "ROTISSERIE" function grills meat or poultry while turning it on a spit for even cooking results.

Use this function for:

- poultry, whole birds,
- tied roasts, e.g. pork loin, beef tenderloin, etc.,
- kebabs.

The roast probe cannot be used at the same time as the rotisserie. The cable could wind around the rotisserie and be damaged.

Poultry legs should be tied together to prevent them from catching on the heating element or burning.

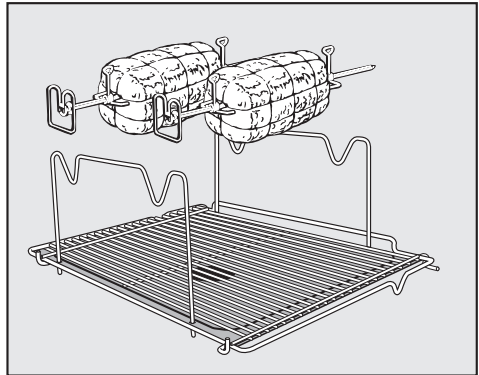

- Assemble the rotisserie as shown.

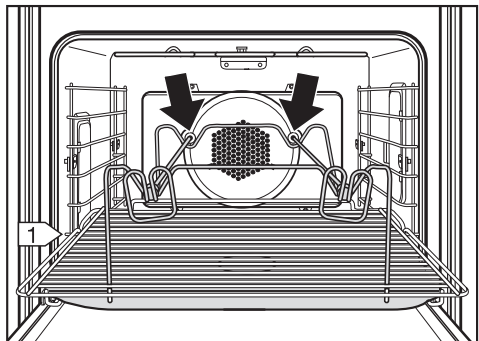

- Put the rotisserie in the oven, using the **lowest** level runner.
- Insert the spits into the grill motors at the back of the oven.
- Select "ROTISSERIE".
- When the oven door is closed, the spits will rotate.

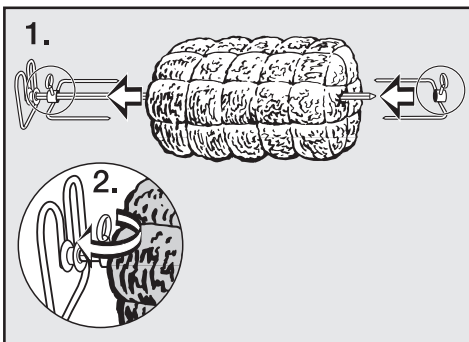

- Secure meat or poultry on the skewers.

If you often cook a recipe with the same settings (function, time, temperature) you can save them as a "favourite" for easy recall.

To save a favourite:

- Enter the function, temperature and cooking times required.
The oven will begin heating.

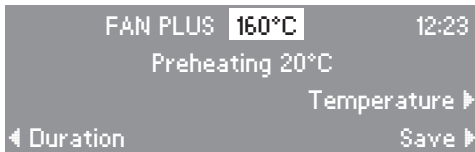

- Touch the "Save" control.

Your "favourite" must be named before it can be saved to the memory.



- Enter the letters and numbers of the name by touching the controls left and right of the alpha-numeric list. Confirm each character entry by touching the "Select" control.
- Touch the "OK" control when naming is complete to save the "favourite" to memory.

Your "favourite" can now be recalled from the "FAVOURITES" list. When selected the oven will automatically use the saved settings.

- Touch "Clear" to cancel the running function if you are not cooking.

SABBATH

SABBATH

Default temperature. 190 °C

For religious observance, the oven can be set to run for the duration of the Sabbath. There will be no visual change to the control panel and the clock will not be displayed.

In this function, only "BAKE" and "CONVENTIONAL" are available.

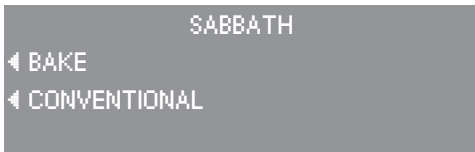

- Select the desired Sabbath function while the door is closed and alter the temperature if necessary.

The oven will stay in "Hold" mode until the oven door is reopened.

- Open the oven door.
- Place the food in the oven.
- Close the oven door.

After a 5 minute delay, the oven will start heating until the set temperature is reached. This temperature will then be held constant for 72 hours.

Once the Sabbath function has started the settings cannot be changed. The oven can only be turned off with the "OFF" control.

At the end of Sabbath

After 72 hours, the oven will shut off and "Fault 55" will appear in the display.

- Turn the oven off to reset it to normal operation.

DRYING

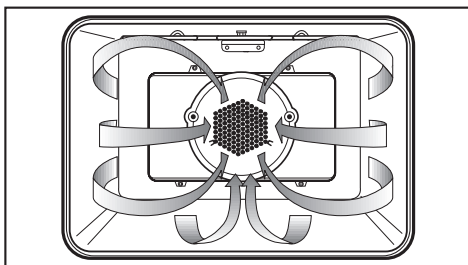

Default temperature 80 °C

This function is for dehydrating fruits, vegetables and herbs.

A consistent low temperature and the fan maintain the ideal conditions for the long dehydration process.

For best results, blot food with a paper towel before dehydrating.

Foods to be dehydrated should be placed directly on the oven racks or on a drying screen (not supplied with oven).

PROVE DOUGH

PROVE DOUGH

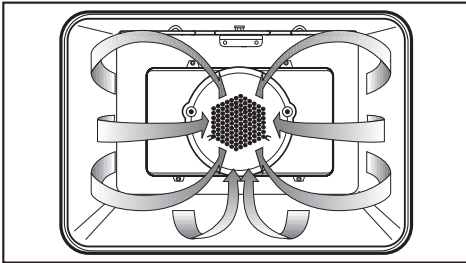

Default temperature: Light mix . . . 43°C
Heavy mix . . . 50°C

The warm environment created in with this function will allow you to effectively prove dough. This function maintains a low temperature perfect for yeast to rise.

Place the dough in a large bowl on the oven rack positioned at the lowest runner level. Keep the oven door closed during this process.

DEFROST

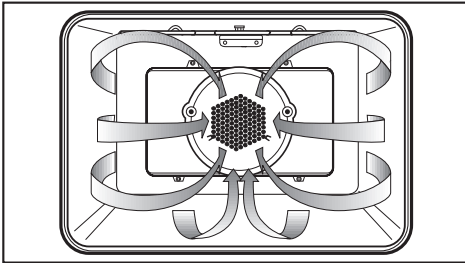

Default temperature 25 °C

This function allows you to defrost food at a constant temperature.

Defrosting times depend on the type and weight of the food, and at what temperature it was deep-frozen.

It is particularly important to observe food hygiene rules when defrosting poultry. Do not use the liquid from defrosted poultry. Pour it away and wash the container it was in, the sink and your hands. Danger of salmonella poisoning.

Never re-freeze partially or fully defrosted food. Consume defrosted food as soon as possible as it will lose its nutritional value and spoil if left for too long. Defrosted food may only be re-frozen after it has been cooked.

Defrosting tips

- Remove the frozen food from the packaging and place it in the roasting pan or into an appropriate dish.
- Meat and poultry should be fully thawed before cooking. Do not use the liquids from defrosting.
- Fish does not need to be fully defrosted before cooking. Defrost so that the surface is soft enough to absorb herbs and seasoning.
- Cook all food immediately after defrosting.

Settings

You can change the standard default settings as follows:

- Switch the oven on.
- Call up the "Settings 
- Call up the sub-menu you require.

Currently selected settings are shown in the display.

Available settings:

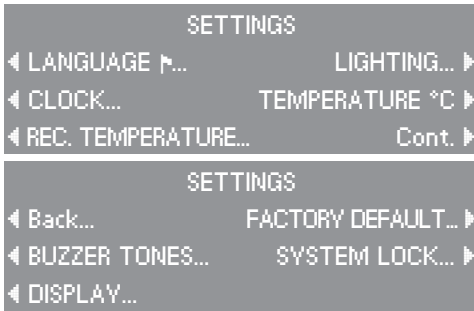

Language

You can set the language you want the display to appear in.

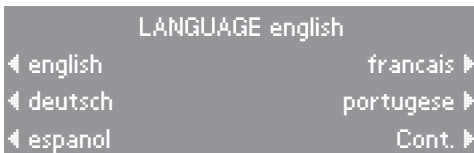

After selecting and confirming "Language", the language you have selected will appear in the display.

If you have selected the wrong language by mistake you can follow the flag symbol  to get yourself back to the "Language" sub-menu.

Clock

"Enter Time" appears in the display.

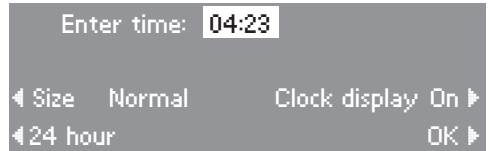

- Enter the current time using the keypad.

Different settings can be selected by touching the control next to the option:

- the size of the clock display,
 - Size Normal
 - Size Large
- the time format,
 - 12 hour
 - 24 hour
- whether or not the time is displayed,
 - Clock-Display On
 - Clock-Display Off
- Touch the "OK" control to confirm the entries.

If power to the oven is cut off for more than 4 days, the clock will have to be reset.

Recommended Temperature

If you frequently change a recommended temperature it may be a good idea to change it permanently.

REC. TEMPERATURE			
◀ BAKE	190°C		
◀ FAN PLUS	160°C	OK ▶	
◀ CONVENTIONAL BAKE	190°C	Cont. ▶	

- Touch the control of the function whose default temperature you wish to alter.
- Enter the new default temperature using the keypad.

The next time this function is selected, the new temperature will be used.

Select the function you want and change the temperature within the range allowed.

Function	°F		°C	
	default	range	default	range
BAKE	375 °F	200-500 °F	190 °C	100-260 °C
FAN PLUS	325 °F	125-500 °F	160 °C	50-260 °C
CONVENTIONAL BAKE	375 °F	125-550 °F	190 °C	50-290 °C
BROWNING	375 °F	200-500 °F	190 °C	100-260 °C
INTENSIVE BAKE	325 °F	200-500 °F	160 °C	100-260 °C
AUTO ROAST	325 °F	200-425 °F	160 °C	100-210 °C
FAN ROAST	325 °F	125-500 °F	160 °C	50-260 °C
CONVENTIONAL ROAST	400 °F	175-550 °F	200 °C	80-290 °C
GRILL (HALF)	no default	400-575 °F	no default	200-300 °C
FULL GRILL	no default	400-575 °F	no default	200-300 °C
FAN GRILL	no default	200-500 °F	no default	100-260 °C
ROTISSERIE	no default	400-575 °F	no default	200-300 °C
DEFROST	75 °F	75-125 °F	25 °C	25-50 °C
SABBATH BAKE	375 °F	200-500 °F	190 °C	100-260 °C
SABBATH CONVENTIONAL	375 °F	125-550 °F	190 °C	50-290 °C

Settings

Lighting

The oven interior lighting can be set so that it goes out 1 minute after a cooking programme has started, or so that it stays on automatically throughout cooking.

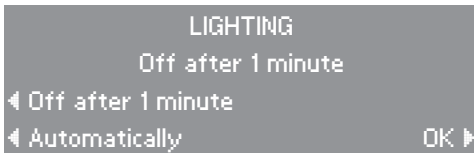

- Touch the control of the light setting you wish to choose.

The selected setting will appear in the display.

- Touch the "OK" control to confirm the selection.

If this option has been set, the lighting can be switched back on for a further minute by pressing one of the sensors next to the display.

Temperature °C / °F

Temperatures can be displayed in °C or °F.



- Touch the "TEMPERATURE" control to toggle between °C and °F.

Buzzer tones

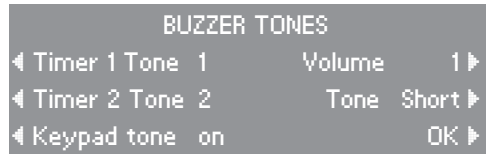

Unique tones may be set for each of the two timers to differentiate the timers from an oven function tone.

– "Timer 1" and "Timer 2"

The tone of Timer 1 and Timer 2 can be set to one of five buzzer tones.

- Select "Timer 1 Tone" or "Timer 2 Tone" by touching the corresponding control.

With every touch of the respective control, another tone will sound and the display will show the tone number.

- Select the tone for each timer.

– "Keypad tone"

The keypad can be set to make a sound with every touch of a control.

- Touch the "Keypad tone" control to toggle between the on and off settings.

– "Volume"

This control adjusts the volume of the Buzzer tones.

- Touch the "Volume" control until you hear the desired volume.

– "Tone Short / Long"

The duration of the timer and oven tones can be modified.

- "Tone short": a beep will sound in quick succession.
- "Tone long": a continuous tone will sound.
- Touch the "Tone" control to toggle between the short and long setting.
- Touch the "OK" control to confirm the "BUZZER TONES" settings.

When the tone sounds to indicate an oven signal or the timer, touch any number on the keypad to turn off the tone.

Display

The brightness and contrast of the oven display can be adjusted by touching the controls next to "Brightness" and "Contrast".

Factory default

The factory settings of the oven can be restored through this function.

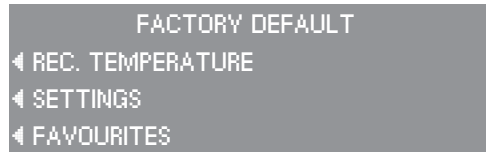

Reset Temperatures

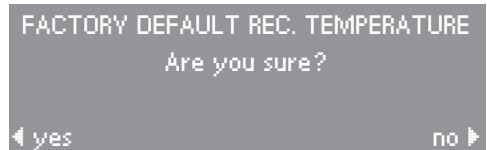

If the request is confirmed with "yes", all changed temperatures will be restored to the factory default.

Reset Settings

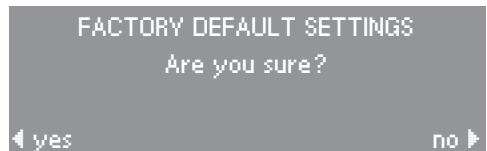

If the request is confirmed with "yes", all changed settings will be restored to the factory default.

Reset Favourites

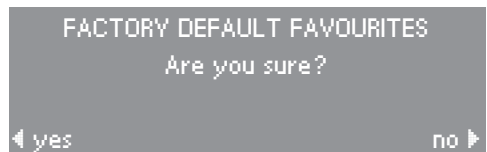

If the request is confirmed with "yes", all "favourite" entries will be deleted. Once deleted, these entries cannot be restored.

System lock

The oven is supplied with this setting deactivated as standard.
To use it you first have to activate it.

The system lock can be activated to prevent children from operating the oven or to conserve standby power when the oven will not be used for some time (e.g. when on holiday).

If activated the  symbol will show in the display when the oven is switched off.

To activate the system lock:

- Touch the "On" control to activate the display.
- Call up the SETTINGS  menu.
- Call up the SYSTEM LOCK submenu.
- Select the touch control next to "Accept" and confirm by touching "OK".
- Touch the "Off" control.

 is displayed at the right side of the display.

To deactivate the system lock:

- Call up the SYSTEM LOCK submenu.
- Select the touch control next to "Do not accept" and confirm by touching "OK".

Using the system lock:

- Select the touch control next to  and confirm "on".

The oven cannot be operated now.

The  symbol indicates that the lock has been activated. The timer can still be used while the lock is on.

The system lock remains active even after a power cut.

To switch the system lock off call up  and confirm "off".

The oven can now be used.

- **Note:** If the system lock is activated for more than 4 days, the oven clock will have to be reset.

In the UK, Miele branded cleaning and conditioning products as well as a microfibre E-cloth, which is suitable for cleaning surfaces such as stainless steel, glass, plastic and chrome without the use of chemicals, are available from the Miele Spare Parts Dept. or via the Internet (depending on country).

Appliance front

Clean the

- controls,
- door handle,
- trim inside the door.

regularly, preferably after each use.

This will help to prevent grease and other deposits adhering to the surfaces and becoming difficult to remove and also in some cases, causing discolouration.

- All surfaces and controls should be cleaned using warm water with a little washing up liquid applied with a soft sponge or cloth.
- Wipe the surfaces dry using a soft cloth.

Do not use scouring agents, hard sponges or brushes or sharp metal tools to clean glass as these can scratch the surface.

To prevent the risk of scratches and damage to the surface structure of your appliance, pay particular attention to the following cleaning instructions.

Stainless steel surfaces

Stainless steel surfaces are susceptible to scratches and abrasion.

Stainless steel surfaces can be cleaned using a Miele E-cloth* or with a proprietary non-abrasive cleaning agent designed specifically for use on stainless steel. N.B. Do not use stainless steel cleaning agents on the controls.

Avoid:

- cleaning agents containing soda, acids or chlorides,
- abrasive cleaning agents, e.g. powder cleaners and cream cleaners,
- abrasive sponges, e.g. pot scourers, or sponges which have been previously used with abrasive cleaning agents.

To help prevent re-soiling, a conditioning agent for stainless steel* can also be used.

* In the UK, Miele branded cleaning and conditioning products as well as a microfibre E-cloth which is suitable for cleaning surfaces such as stainless steel, glass, plastic and chrome without the use of chemicals are available from the Miele Spare Parts Department or via the internet on www.miele.co.uk.

Cleaning and care

Accessories

Remove all accessories as well as the runners from the oven interior before starting the pyrolytic cleaning process. The high temperatures needed for pyrolysis will damage the accessories and cause irreparable damage.

Grill pan, anti-splash tray and racks

The surfaces of these have been treated with **PerfectClean enamel**.

Please refer to the section "PerfectClean" for information on cleaning and care.

Runners

The runners are coated with pyrolytic enamel and can be left in the oven during a pyrolytic cleaning programme.

Roasting filter

Clean in a solution of hot water and a little washing up liquid or in the dishwasher.

If cleaned in the dishwasher, results are better if the filter is placed horizontally in the basket.

Some dishwasher detergents may cause the surface of the metal filter to discolour. This discolouration will not affect the functioning of the filter in any way.

The roasting filter, unlike other accessories, can be pyrolytically cleaned. Although this may cause permanent discolouration, it will not affect the functioning of the filter in any way.

Roast probe

This should be wiped clean with a damp cloth only.

Do not put the roast probe into water, or clean it in the dishwasher as this would damage it.

Rotisserie

Clean in a solution of hot water and a little washing up liquid.

If necessary a non-abrasive proprietary stainless steel cleaner may be used.

PerfectClean

Before using for the first time remove any stickers from PerfectClean surfaces.

The enamelled surfaces of the grill pan, anti-splash tray and rack have been treated with a special type of enamelling called **"PerfectClean"**.

This surface has very good anti-stick properties which is much easier to keep clean than conventional oven enamel, if cleaned regularly.

Food can be taken off it more easily and soiling from baking and roasting is easier to remove.

The following notes on cleaning and care should ensure that the anti-stick and easy clean properties of PerfectClean last for many years.

PerfectClean surfaces can be treated as you would treat glass. If you are unsure whether a particular cleaning product is suitable for PerfectClean consider whether you could clean a window pane with the product without damaging it.

Food can be sliced or cut up on the PerfectClean surface in the same way as on a baking tray with conventional enamel.

Allow the oven and any accessories to cool down before cleaning.
Danger of burning!

Normal soiling

Clean as soon as possible after each use with a dishcloth, soft sponge or a soft nylon brush, and a solution of hot water and a little washing-up liquid. The longer soiling is left the harder it may become to remove.

Stubborn soiling

Stubborn soiling e.g. from roasting may need to be soaked first with a damp sponge to loosen it and if necessary a non-abrasive stainless steel spiral pad or a scraper suitable for glass surfaces can be used to remove it.

After cleaning rinse thoroughly with clean water. The water must run off the surface easily. Any residual cleaning agents will hinder this effect.

Using oven sprays on very stubborn soiling

Some oven cleaners contain strong alkalines and / or abrasive materials. Because the enamel is designed to be easily cleaned the use of these cleaners is not recommended. However if you still cannot get the surface clean, an oven cleaner can be used for a couple of minutes only. Do not attempt to use on a hot oven or accessories. Allow the PerfectClean surfaces to cool down to room temperature before applying oven sprays!

Cleaning and care

Apply a spray oven cleaner to the soiled areas. Leave to take effect for **a couple of minutes only!**

If necessary use a soft sponge, soft nylon brush or a scraper suitable for glass surfaces to loosen the soiling.

Repeat the process if necessary.

After cleaning rinse thoroughly with clean water and then dry thoroughly.

Important

For optimum performance of the PerfectClean enamel it is important to clean the oven and accessories after each use.

The surfaces will become harder to clean and the anti-stick properties will deteriorate if soiling is not removed after each use and allowed to build-up. In extreme cases cleaning may even become impossible.

The following cause lasting damage to the surface structure and reduce the anti-stick effect and must not be used on PerfectClean surfaces:

- abrasive cleaning agents
- wire wool or metal scourers
- pot scourers
- oven cleaning pads
- sponges and cloths which have previously been used with abrasive cleaning agents.
- oven spray must not be used in a hot oven or left on for too long.
- items coated with PerfectClean enamelling must not be cleaned in a dishwasher.

Note

Soiling such as spilt juices and cake mixtures are best removed whilst the oven or tray is still warm. Exercise caution, make sure the oven is not hot - danger of burning!

Spilt fruit juices may cause lasting discolouration of the surfaces and roasting can cause matt areas to appear. Clean these following the instructions given above and do not try and use force to remove them! This discolouration is permanent but will not affect the efficiency of the enamel.

When baking items with a high salt content (e.g. continental pretzels) place them on baking parchment in the baking tray or grill pan. Sodium deposits can cause lasting discolouration to PerfectClean surfaces.

Oven interior

The side runners, oven interior, back panel and roof liner are coated with **pyrolytic enamel** which facilitates cleaning.

This is a particularly hard enamel with an extremely smooth surface. Because of its anti-stick properties most debris can be easily removed with warm water and a little washing-up liquid applied with a soft cloth. This should be done after each use.

Allow the oven to cool down before cleaning.

Danger of burning!

Never use hard brushes, hard sponges, wire wool pads*, knives or any other abrasive materials or cleaning agents. They can damage the enamel.

If using an oven spray, the manufacturer's instructions must be followed.

* non-abrasive stainless steel spiral pads can be used

Pyrolytic cleaning of the oven interior

You can set the "PYROLYTIC" function for both ovens at the same time.

However, the cleaning process will run one after another. This means the oven which was programmed first, will be cleaned first.

The status of the cleaning process is shown in the display.

Before starting a pyrolytic cleaning process please note the following advice:

Remove any coarse soiling from the oven before you start.

Clean the interior glass door panel thoroughly. Otherwise, splashes on the door may burn on making them difficult to remove.

There is a fibre-glass door seal around the oven cavity.

This seal is particularly sensitive and should not be cleaned unless absolutely necessary. Rubbing the seal can damage it.

Remove all accessories (except the side runners) from the oven interior before starting the pyrolytic cleaning process. The high temperatures needed for pyrolysis will damage the accessories and cause irreparable damage.

The oven door gets much hotter during pyrolytic operation than during normal use.

Make sure children cannot touch the oven whilst a pyrolytic programme is running. Danger of burning.

Cleaning and care

During the pyrolytic process the oven is heated to approx. 460 °C. Any residual soiling is burnt off by the high temperatures.

The pyrolytic programme duration will vary depending on the level of soiling.

For safety reasons the **oven door is automatically locked** at the beginning of the pyrolytic programme.

At the end of the programme it will not be unlocked until the temperature inside the oven has dropped to below 280 °C.

If the pyrolytic cleaning programme has been started by mistake or if the process is interrupted, the door lock will be released:

- immediately if the temperature is below 280 °C.
- not until the oven interior temperature is below 280 °C if the temperature inside the oven is higher than 280 °C.

Starting a pyrolytic process

- Take all accessories out of the oven.
- Select the "PYROLYTIC" function.
- Start the pyrolytic cleaning process.

The appliance door will lock.

You can **delay the start of the pyrolytic process** for example, to take advantage of cheaper night electricity tariffs. To do so:

- Call up "Start time" and select a time to start the programme at.

You can change the start time if you wish at any time up until the delay period has elapsed.

At the end of the programme a buzzer will sound and the message "Ready" will appear in the display.

- Switch off the oven.

After the pyrolytic process any debris (e.g. ash), can easily be wiped away.

Remember to wait until the oven has cooled down before doing so!
Danger of burning.

Try not to wipe the fibre-glass seal when cleaning the oven cavity. It is particularly sensitive and should not be cleaned unless absolutely necessary. Rubbing it can damage it.

Most residues are easily wiped away with a damp cloth.

Depending on soiling levels in the oven there may be visible deposits on the door and below the trim under the oven cavity. This is best removed using a non-abrasive sponge or non-abrasive stainless steel spiral pad and a mild solution of warm water and washing-up liquid.

Deposits on the internal door panel can be removed using a suitable glass scraper.

Spilt fruit juices may cause lasting discolouration to the surfaces. This discolouration is permanent but will not affect the efficiency of the enamel. Do not attempt to remove these marks.

The **pyrolytic process will be cancelled**,

- if the soiling levels in the oven are too much for the programme to deal with.
The message "Fault - 23" will appear in the display.
Remove all coarse soiling before starting the pyrolytic process again.
- if the oven is switched off.
- in the event of a power cut.
Switch the appliance off. If the oven interior temperature is below 280 °C, the door lock will be released after a period of approx. 30 seconds. It can then be opened.
Start the pyrolytic cleaning process again if necessary.

Cleaning and care

To remove the oven door

Please note: the oven door is heavy and should be gripped firmly at both sides when being removed or refitted.

The oven door is connected to the oven by hinges.

Before removing the door, the locking clamps on both hinges have to be released.

- Open the door fully.



- To release the locking clamps on the hinges. See illustration.

- Then lift the door upwards as far as it will go.

Do not attempt to take the door off the hinge guides when it is in a horizontal position. The guides will close, and damage the appliance. Danger of injury.

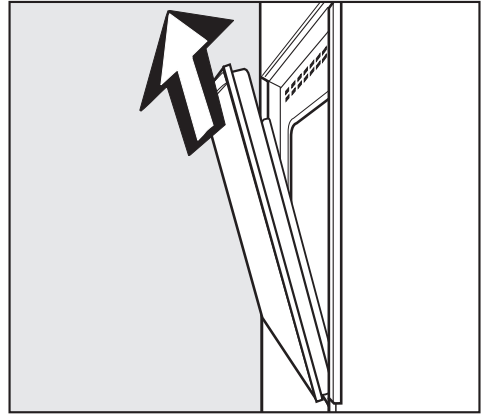

- Hold the door securely at both sides and lift upwards off the hinge guides.

Do not lift the door off by the handle. The handle could break and damage the glass.

Make sure that you lift the door off equally on both sides.

To refit the door

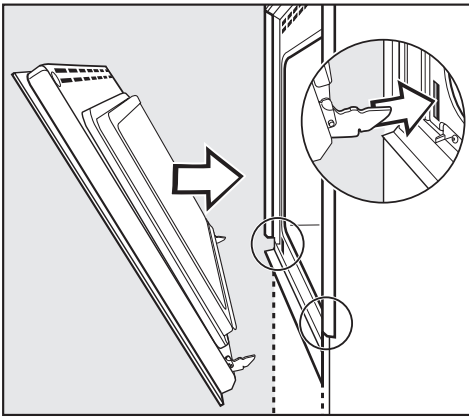

- Hold the door securely at both sides and carefully fit it back onto the hinges.
- Open the door fully and flip the locking clamps down.

It is essential that the locking clamps lock securely when the door is re-fitted after cleaning. Otherwise the door could work loose from the hinges, resulting in damage to the door.

To remove the runners

Make sure the oven heating elements are switched off and cool. Danger of burning.

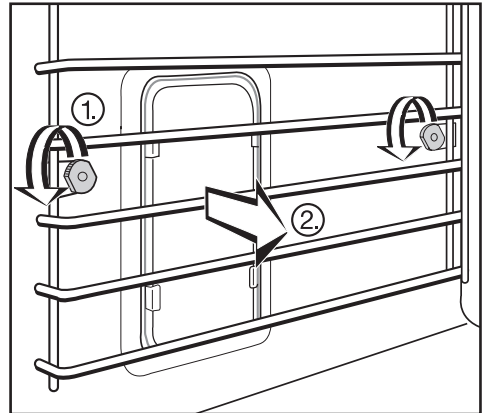

- Pull on the fixing knob to release it.
- Remove the runners.

Reassemble in the reverse order, carefully ensuring all parts are correctly in place.

Cleaning and care

Lowering the upper heating element

- First remove the runners.

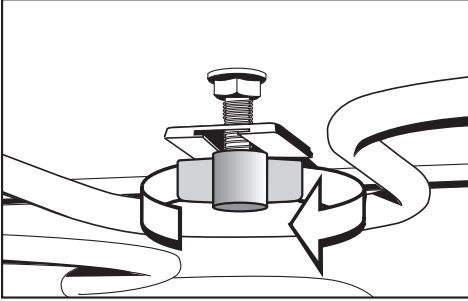

- Loosen the wing nut.

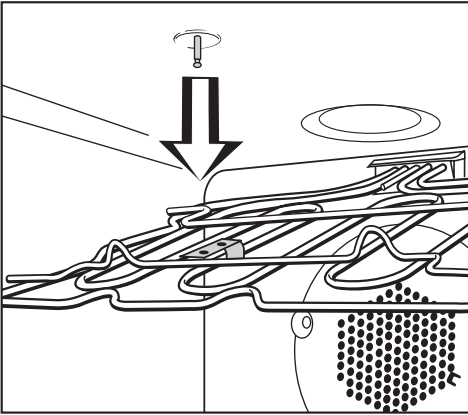

- **Gently** lower the upper heating element.

Do not use force to lower it, as this could cause damage.

Reassemble in the reverse order, carefully ensuring all parts are correctly in place.

Installation, maintenance and repairs may only be carried out by suitably qualified and competent persons in accordance with local and national safety regulations. Repairs and other work by unqualified persons could be dangerous, and the manufacturer will not be held liable for unauthorised work. Ensure current is not supplied to the appliance until after maintenance or repair work has been carried out.

Some minor problems can be corrected without contacting the Miele Service Department.

What to do if . . .

. . . the oven does not heat up.

Check whether,

- the system lock has been activated.
- the mains fuse has blown. Contact a qualified electrician or the Miele Service Department.

. . . the heating works, but not the oven lighting.

The halogen lamp needs replacing.

To change the lamp:

- Disconnect the appliance from the electricity supply. Switch off and unplug at the socket, or remove the fuse, or switch off at the isolator as appropriate.
- Remove the runners.

- Cover the floor of the oven with a towel to protect the enamelling just in case the lamp cover is dropped.

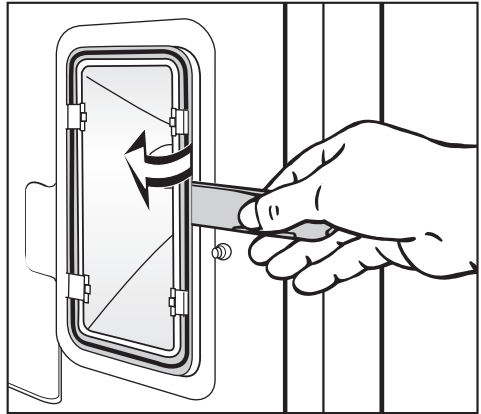

- Use the lever to release the lamp cover from its frame.

The glass cover is held in position by two metal brackets which are secured to the reflector.

Do not push the metal brackets to the sides, as this would damage both the brackets and the reflector. It might also make it difficult to push the glass cover back into its frame again.

Problem solving guide

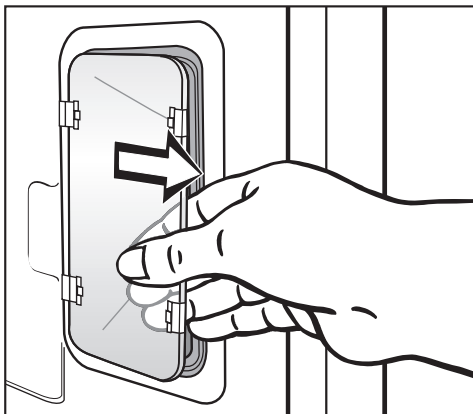

- Pull the glass cover out of the rear metal brackets.
- Pull the defective halogen lamp out. When purchasing a new lamp it is a good idea to take the old one with you to make sure you get the correct replacement (12 V, 20 W, heat resistant to 300 °C, G4 fitting, Osram, Type 64428).

Do not touch the surface directly when changing the lamp as grease particles from your fingers will adhere to the surface and damage the lamp. Please follow the manufacturer's instructions.

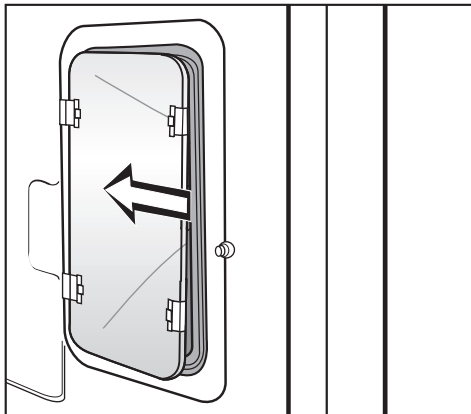

- Push the glass cover back into the metal brackets with the cut out edge towards the rear.

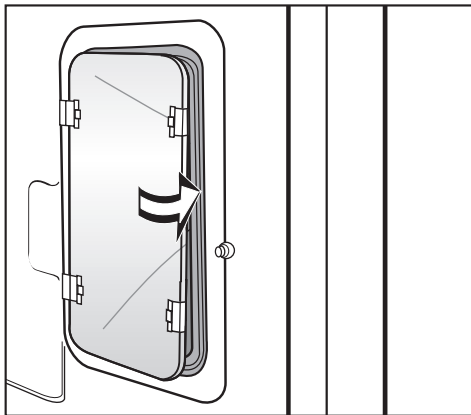

- Push the glass cover into its frame at the front.
- Replace the runners.

Reassemble in the reverse order, carefully ensuring all parts are correctly in place.

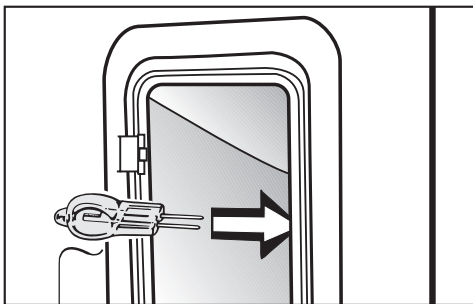

- Replace it with a new one, making sure it goes into its socket horizontally.

. . . no noise is heard when the oven door is opened during operation.

This is not a fault.

If the door is opened during operation, the door contact switch causes the oven heating, and the fan if using a "Fan" setting, to be switched off.

. . . a noise can be heard after baking, roasting or grilling.

This is not a fault. The cooling fan continues to run for a while after the oven has been switched off to prevent any humidity building up in the oven, on the control panel or in the oven housing unit.

It will switch off sooner if the oven door is opened partially or fully.

. . . cakes and biscuits are not cooked properly.

Check whether,

- the correct temperature was set.
- there has been a change to the recipe. The addition of more liquid or more eggs makes a moister mix which would need longer to cook.
- The roasting filter had been left in place in front of the fan when cooking with "Fan plus" or "Intensive bake": In this case baking times might be lengthened by 10 to 15 minutes.

. . . cakes or biscuits are unevenly browned.

There will always be a slight unevenness.

If browning is very uneven, check with **FAN PLUS**:

- whether the temperature was set too high,
- whether the roasting filter was in place.
- whether the correct runner height was used.

with **CONVENTIONAL**:

- the colour and composition of the baking tins being used. Light coloured, shiny, or thin walled tins are less suitable.
- whether the correct runner height was used.

Problem solving guide

... a fault message appears in the display

Faults which you can rectify yourself, are indicated by the following message "Please read notes in the operating instruction booklet".

Fault 23

The pyrolytic temperature of approx. 460 °C was not reached. This could have been caused by too much soiling in the oven to start with. Remove all coarse soiling before starting the pyrolytic cleaning programme again. If the fault message appears again please contact the Miele Service Department.

Fault 32

The door lock for the pyrolytic cleaning programme has not shut. Interrupt the pyrolytic cleaning programme by switching the oven off. Then start it up again. If the fault message appears again please contact the Miele Service Department.

Fault 33

The door lock for the pyrolytic cleaning programme will not open. Interrupt the pyrolytic cleaning programme by switching the oven off. Then start it up again. If the door lock will still not open please contact the Miele Service Department.

Fault 54

The roast probe is defective. Remove the probe from its socket and the message will disappear.

Fault 55

The oven has automatically switched itself off during use. This is a safety feature to protect the oven if it has been operating for an exceedingly long period. The length of time depends on the oven function selected. The oven can be used again immediately by simply turning the oven off and on again.

Faults which you cannot rectify yourself, are indicated by the following message "Please call the Service Department.".

In the event of any faults which you cannot remedy yourself, please contact

– your Miele Dealer

or

– the Miele Service Department
(see back cover for contact details).

When contacting your Dealer or the Service Department, please quote the model and serial number of your appliance.

These are shown on the data plate, visible at the right side of the oven interior, with the door fully open.

Please note that telephone calls may be monitored and recorded for training purposes.

Extra accessories

The following accessories may come are standard with some models. They are available at extra cost from your Miele Dealer, the Miele Spare Parts Department or via the Internet (depending on country).

Pizza pan

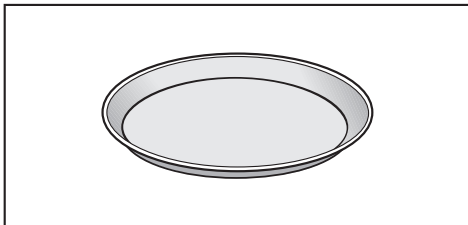

This circular pan is suitable for cooking pizzas, flat cakes made with yeast or whisked mixtures, sweet and savoury tarts, baked desserts, and can also be used for deep frozen cakes and pizzas.

Baking stone

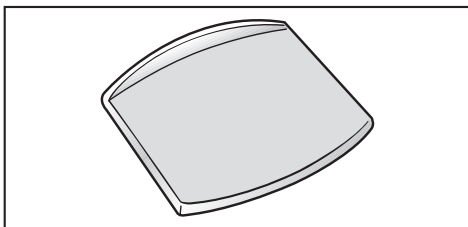

The baking stone is ideal for items which need a well baked base such as pizza, quiche, bread, bread rolls and savoury snacks.

The baking stone is made from heat retaining fire brick and is glazed. Place it directly on the rack.

A paddle made of untreated wood is supplied with it for placing food on the baking stone and taking it off.

Gourmet oven dish

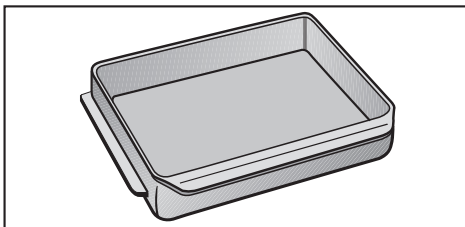

The gourmet oven dish can be placed in the oven directly on the runners. It has non-tip safety notches like the oven tray to prevent it being pulled out too far.

The dish has a special protective anti-stick coating.

It is available in two sizes:

HUB 61-22, 8 - 10 servings,

W x D x H: 38 x 22 x 8.6 cm

HUB 61-35, 16 - 20 servings,

W x D x H: 38 x 35 x 8.6 cm

A lid is available separately.

All electrical work should be undertaken by a suitably qualified and competent person in strict accordance with current national and local safety regulations (BS 7671 in the UK).

Installation, repairs and other work by unqualified persons could be dangerous. The manufacturer cannot be held liable for unauthorised work.

Ensure power is not supplied to the appliance until after installation or repair work has been carried out.

The **voltage and connected load** are given on the data plate, visible with the oven door open. Ensure that these match the household mains supply. Please quote these data, and the model and serial number when contacting the Miele Service dept.

Connection of this appliance should be made via a suitable isolator, which complies with national and local safety regulations, and the on/off switch should be easily accessible after the appliance has been built in.

If the switch is not accessible after installation (depending on country) an additional means of disconnection must be provided for all poles.

For extra safety it is advisable to install a residual current device with a trip current of 30 mA (in accordance with DIN VDE 0664, VDE 0100 Section 739).

When switched off there must be an all-pole contact gap of 3 mm in the isolator switch (including switch, fuses and relays acc. to EN 60 335).

This device is intended for the connection to a power supply system with a maximum permissible system impedance Z_{MAX} of 0.42 Ohm at the interface point (power service box) of the user's supply.

The user has to ensure that this device is connected only to a power supply system which fulfills the requirement above. If necessary, the user can ask the public power supply company for the system impedance at the interface point.

Important U.K.

This appliance is supplied with a 3-core cable for connection to a single phase 230 V 50 Hz supply.

The wires are coloured in accordance with the following code:

Green/yellow	= earth
Blue	= neutral
Brown	= live

In other countries check these details with your supplier.

WARNING
THIS APPLIANCE MUST BE EARTHED.

Position of the data plate (lower oven)

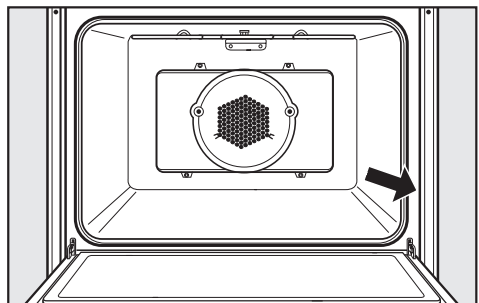

Installing the oven

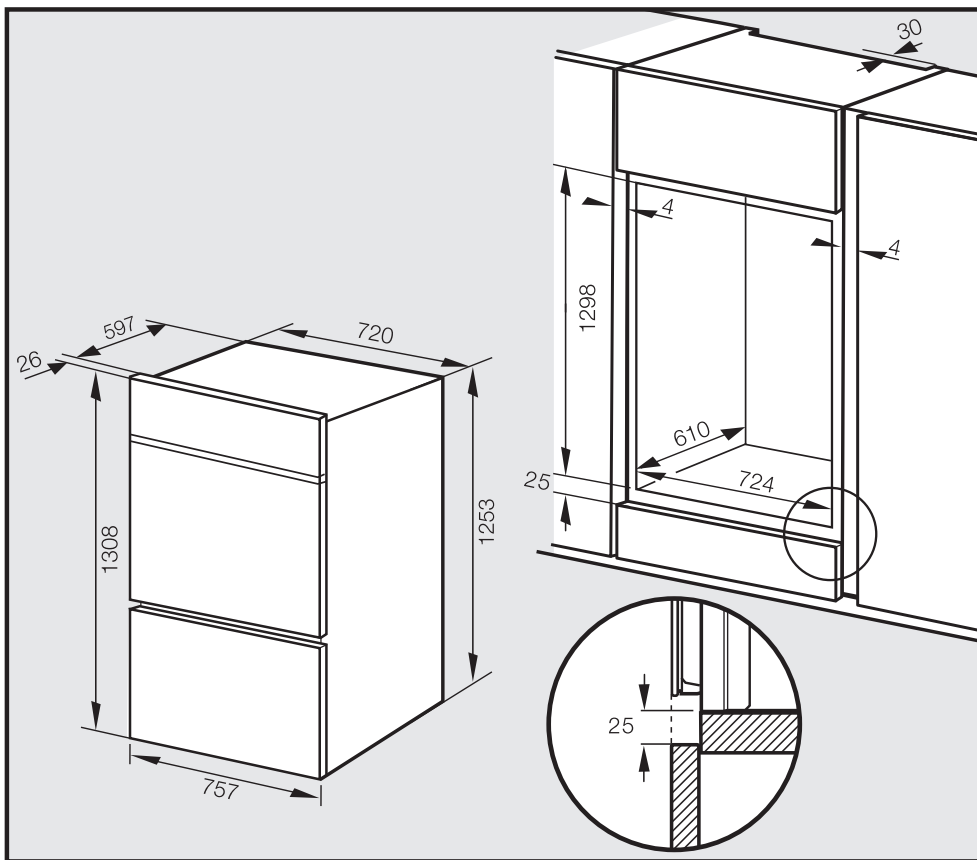

Installing the oven

To ensure adequate ventilation to the oven once installed:

- provide a ventilation cut-out in the housing unit as illustrated.
- do not fit a rear panel into the housing unit.
- do not fit insulation material inside the housing unit.

Turn off the mains electricity supply to the isolator.

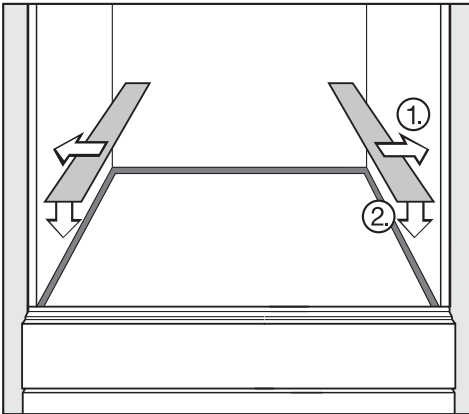

- Adhere the skid plates to the cabinet floor.



- Prepare the doors for removal. Flip up the locking clamps on each door hinge.

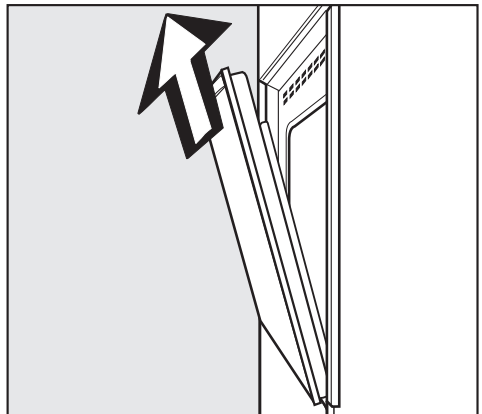

- Slowly shut the door until the protruding clamps stop the movement. Pull the door upward and off. Repeat with the other door.
- Connect the mains cable from the oven to the isolator.
- Push the oven into the furniture housing unit as far as the oven trim, and align it.

Installing the oven

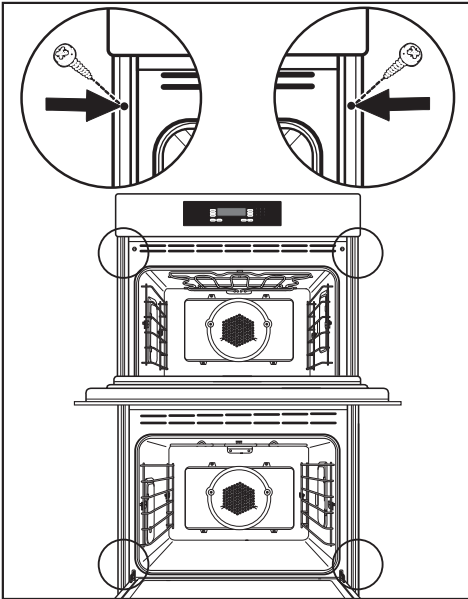

- Locate the four mounting screw holes in the oven frame. Mark and drill 6 mm pilot holes. Secure the oven to the cabinetry by inserting screws through the frame and into the cabinetry.
- Reinstall the doors.
- Reconnect the electricity supply to the isolator.

The appliance must only be operated when it has been built in. Otherwise it poses an electric shock hazard.

Miele

United Kingdom

Miele Co. Ltd.
Fairacres, Marcham Road
Abingdon, Oxon, OX14 1TW
Tel: (01235) 554455
Fax: (01235) 554477
Customer Contact Centre Tel: (08707) 554466
E-mail: info@miele.co.uk
Internet: www.miele.co.uk

Australia

Miele Australia Pty. Ltd.
ABN 96 005 635 398
1 Gilbert Park Drive, Knoxfield, VIC 3180
Tel: (03) 9764 7130
Fax: (03) 9764 7149
Internet: www.miele.com.au

China

Miele Shanghai
Suite 4105-06, Plaza 66
1266 Nanjing Road West
Jing An District
Shanghai 200040, PRC
Tel: +86 21 6288 4200
Fax: +86 21 6288 4100
E-mail: mieleshanghai@cn.miele.com
Internet: www.miele.cn

Hong Kong

Miele (Hong Kong) Limited
AIA Plaza, 24th Floor
18 Hysan Avenue
Causeway Bay
Tel: +852- 2610-1331
Fax: +852-2610-1013
E-mail: mielehk@miele.com.hk
Internet: www.miele.hk

Ireland

Miele Ireland Ltd.
Broomhill Road, Tallaght, Dublin 24
Tel: (01) 461 0710
Fax: (01) 461 07 97
E-Mail: info@miele.ie
Internet: www.miele.ie

New Zealand

Miele New Zealand Limited
Unit L, 10-20 Sylvia Park Road
Mt. Wellington, 1060, Auckland, NZ
Tel: 0800 264 353
Fax: 0800 463 453
Internet: www.miele.co.nz

South Africa

Miele (Pty) Ltd
63 Peter Place, Bryanston 2194
P.O. Box 69434, Bryanston 2021
Tel: +27 (0) 11 548-1900
Fax: +27 (0) 11 548-1935
E-mail: info@miele.co.za
Internet: www.miele.co.za

Singapore

Miele Southeast Asia
Miele Pte. Ltd.
163 Penang Road
04 - 02/03 Winsland House II
Singapore 238463
Tel: +65 6735 1191
Fax: +65 6735 1161
E-Mail: infosea@miele.com.sg
Internet: www.miele.sg

United Arab Emirates

Miele Appliances Ltd.
P.O. Box 11 47 82
Gold & Diamond Park
Sheikh Zayed Road
Building 6 / Offices Nos. 6-214 to 6-220
Dubai
Tel: +971-4-341 84 44
Fax: +971-4-341 88 52
E-Mail: info@miele.ae
Internet: www.miele.ae

Alteration rights reserved / 22 / 4608

M.-Nr. 07 077 710 / 01

(H 4890 BP2)



Free Manuals Download Website

<http://myh66.com>

<http://usermanuals.us>

<http://www.somanuals.com>

<http://www.4manuals.cc>

<http://www.manual-lib.com>

<http://www.404manual.com>

<http://www.luxmanual.com>

<http://aubethermostatmanual.com>

Golf course search by state

<http://golfingnear.com>

Email search by domain

<http://emailbydomain.com>

Auto manuals search

<http://auto.somanuals.com>

TV manuals search

<http://tv.somanuals.com>