

Miele

Operating and Installation Instructions



Oven H 4894 BP2

To prevent accidents
and machine damage,
read these instructions

before

installation or use.

en - US, CA

M.-Nr. 07 964 290

Contents

IMPORTANT SAFETY INSTRUCTIONS	4
Guide to the oven	8
Guide to the display	9
Oven accessories	11
Wire rack	11
Roasting pan	11
Roast probe	12
Rotisserie	12
Slide opener	12
Locking the oven	13
Using the system lock:	13
Using the oven display	14
SETTINGS	15
Language 	16
Clock	16
Temperatures	17
Oven Light	18
Temperature °F / °C	18
Tone Options	19
Display	20
Reset	21
System lock	21
Before using the oven	22
Using the oven	24
Selecting a function	24
Adjusting the oven temperature	24
Preheating	25
Delay Start	26
Duration	26
Start time	27
End time	27
Canceling a process	28
Turning off the oven	28
At the end of cooking	28
Setting the timer	29

Guide to the functions	31
BAKE	32
Baking tips	32
ROAST	37
Roasting tips	40
Using the roast probe	41
MASTER CHEF	44
BROIL	47
Broiling tips	52
FAVORITES	53
SABBATH	54
DEHYDRATE	55
PROOF	56
DEFROST	57
Defrosting tips	57
Cleaning and care	58
Front of appliance	58
PerfectClean	59
Removing the oven door.	61
Removing the runners.	62
Lowering the upper heating element	63
Self Cleaning	64
Changing the light bulb	66
Frequently asked questions	68
Technical Service	69
Optional accessories	70
Installation instructions	73
Caring for the environment	74
Disposal of the packing materials	74
Disposal of an old appliance	74
Electrical connection	75
Appliance and Cut-out Dimensions	76
Installing the oven	77

IMPORTANT SAFETY INSTRUCTIONS

This appliance is intended for residential use only.

Only use the appliance for its intended purpose.

This appliance complies with current safety requirements. Improper use of the appliance can lead to personal injury and material damage.

Read all instructions before installing or using the oven for the first time.

Keep these operating instructions in a safe place and pass them on to any future user.

Use

▶ The appliance is intended for domestic use only: cooking, baking, roasting, broiling, defrosting and heating of food.

It is not designed for industrial or laboratory use.

▶ Do not use the appliance to store or dehydrate flammable materials. This is a fire hazard.

▶ Persons who lack physical, sensory or mental abilities, or experience with the appliance should not use it without supervision or instruction by a responsible person.

Children

▶ Children should not be left unattended in an area where the appliance is in use. Never allow children to hang or lean on any part of the appliance.

▶ Children should not use the unit without supervision unless its operation has been sufficiently explained so they can run it safely. Children must be able to recognize potential hazards or improper operation.

▶ Do not allow children to touch or play in, on or near the oven when it is in operation. The oven gets hot at the oven door glass, the vapor vent, the handle and the operating controls. Danger of burns.

IMPORTANT SAFETY INSTRUCTIONS

Installation

▶ Before installation, make sure that the voltage and frequency listed on the data plate correspond with the household electrical supply. This data must correspond to prevent injury and machine damage. Consult a qualified electrician if in doubt.

▶ Be certain your appliance is properly installed and grounded by a qualified technician.

To guarantee the electrical safety of this appliance, continuity must exist between the appliance and an effective grounding system. It is imperative that this basic safety requirement be met. If there is any doubt, have the electrical system of the house checked by a qualified electrician.

▶ The oven is not to be operated until it has been properly installed within cabinetry.

▶ Installation, maintenance and repair work should be performed by an authorized service technician. Work by unqualified persons could be dangerous and may void the warranty.

▶ Before installation or service, disconnect the power supply to the work area by removing the fuse, "tripping" the circuit breaker, or shutting off the power main.

Oven use

 **WARNING:** Ovens can produce high temperatures that can cause burns.

▶ Prevent children from touching the appliance while in use.

▶ Use heat-resistant potholders when placing items in the oven, turning them, or removing them from the oven. The upper heating element and oven racks can become very hot and cause burns.

▶ To prevent burns, always place oven racks at their desired height while the oven is cool.

▶ Open the door carefully to allow hot air or steam to escape before placing or removing food.

▶ To prevent burns, allow the heating element to cool before cleaning by hand.

▶ During the self cleaning function the oven will become very warm. Prevent children from coming in contact with the oven.

▶ Remove all accessories from the oven before starting the self cleaning function. The high temperatures needed for this program will damage the accessories.

▶ The door gasket is essential for a good seal. Care should be taken not to rub, damage or move the gasket.

▶ Only clean parts listed in this manual.

IMPORTANT SAFETY INSTRUCTIONS

- ▶ **Caution:** Heating elements may be hot even though they are not glowing. During and after use, do not let clothing or other flammable materials come in contact with heating elements or interior surfaces of the oven until they have had sufficient time to cool. External parts of the oven such as the door glass, vents, and the control panel can become hot.
- ▶ Do not block any vent openings.
- ▶ Aluminum foil should not be used to line the oven floor. To avoid damage, do not place pots, pans or baking sheets directly on the oven floor.
- ▶ Do not let metal objects (aluminum foil, pans) or the meat probe come in contact with the heating element.
- ▶ Do not slide pots or pans on the oven floor. This could scratch and damage the surface.
- ▶ Do not lean, sit, or place heavy items on the open oven door.
- ▶ Only use the Miele roast probe supplied with the oven. Contact Miele if you need to purchase a new probe.
- ▶ To prevent damage, remove the roast probe from the oven when it is not being used.
- ▶ Do not heat unopened containers of food in the oven, pressure may build up and cause them to explode.
- ▶ Never add water to food on a hot tray or pan, or directly onto food in a hot oven. The steam created could cause serious burns or scalds.
- ▶ This oven must only be used for cooking. Do not use it as a dryer, kiln, dehumidifier, etc. Fumes or vapors given off by glues, plastics or flammable liquids and materials could be hazardous.
- ▶ Never store flammable liquids and materials in, above or under an oven, or near cooking surfaces.
- ▶ When baking frozen pizzas or pies, place them on the rack lined with parchment paper. Do not use the baking tray or the roasting pan for frozen foods with a large surface area. The tray or pan could become warped and difficult to remove from the oven when hot. Frozen food like french fries, fish sticks, chicken fingers etc. can be baked on the baking tray.
- ▶ Always check that food is sufficiently heated. The time required varies depending on a number of factors, such as initial temperature, quantity, type and consistency of the food, and changes in the recipe. Germs present in the food are killed off only at a sufficiently high temperature (> 158 °F / 70 °C) and after a sufficiently long time (> 10 Min.). Select a longer cook time if you are unsure if food is thoroughly heated. To ensure temperature is distributed evenly, stir and rotate food occasionally before serving.

IMPORTANT SAFETY INSTRUCTIONS

General notes

▶ Do not use a steam cleaner to clean the oven. Steam could penetrate electrical components and cause a short circuit.

▶ Children should not be left alone or unattended in an area where an oven is in use. Never allow children to sit or stand on any part of the oven.

Caution: Do not store items of interest to children in cabinets above an oven. Children climbing on the oven to reach these items could be injured.

▶ Do not leave the oven unattended when cooking with oils or fats, they are a fire hazard if overheated.

▶ Do not use water on grease fires! Smother the fire with a properly rated dry chemical or foam fire extinguisher.

▶ Be aware of loose fitting or hanging garments while operating the cooktop, they present a fire hazard.

▶ Do not use the oven to heat the room.

▶ Make certain that the power cords of small appliances do not come in contact with or get caught in the oven door.

▶ Use only dry, heat resistant potholders. Moist or damp potholders used on hot surfaces may result in steam burns. Do not let potholders come in contact with oils. Do not substitute towels or other bulky items for potholders.

▶ It is recommended to cover all cooked food that is left in the oven to be kept warm. This will prevent moisture from condensing on the interior of the oven.

▶ Be careful when using alcoholic beverages like rum, whiskey, wine etc. for baking or roasting. The alcohol evaporates at high temperatures but may in rare circumstances combust on the hot heating elements.

SAVE THESE INSTRUCTIONS AND REVIEW THEM PERIODICALLY

Guide to the oven

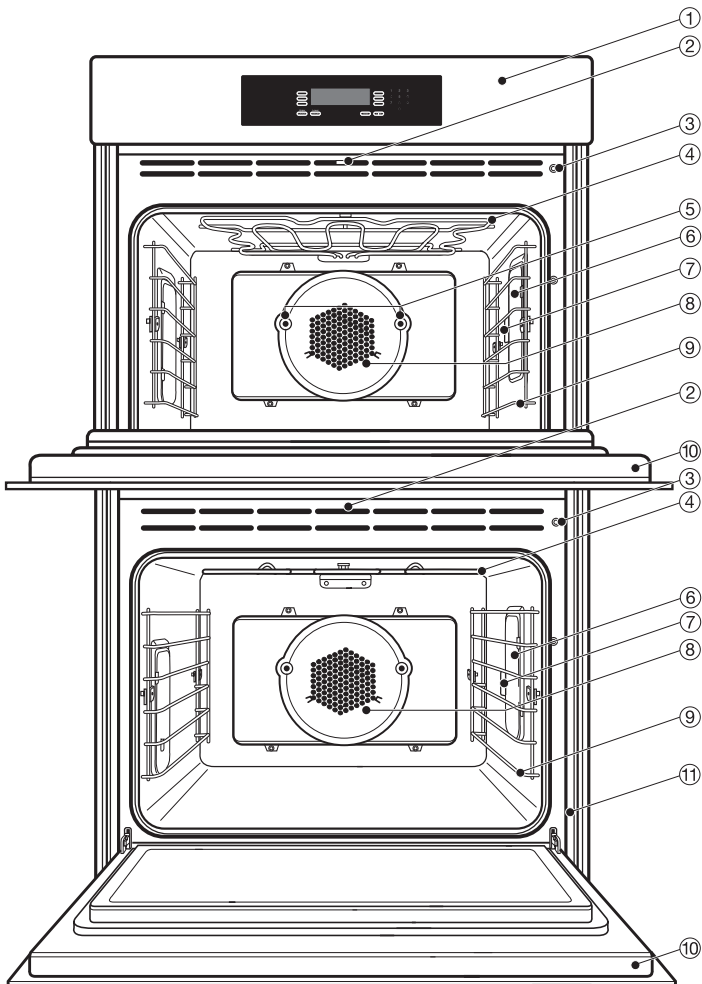

① Control panel

② SELF CLEAN door lock

③ Door contact switch *

④ Upper heating element

⑤ Rotisserie motors

⑥ Light

⑦ Roast probe socket

⑧ Convection fan

⑨ Non-tip, six-level runners

⑩ Oven door

⑪ Data plate

* This switch shuts off the heating element and convection fan when the door is opened during use.

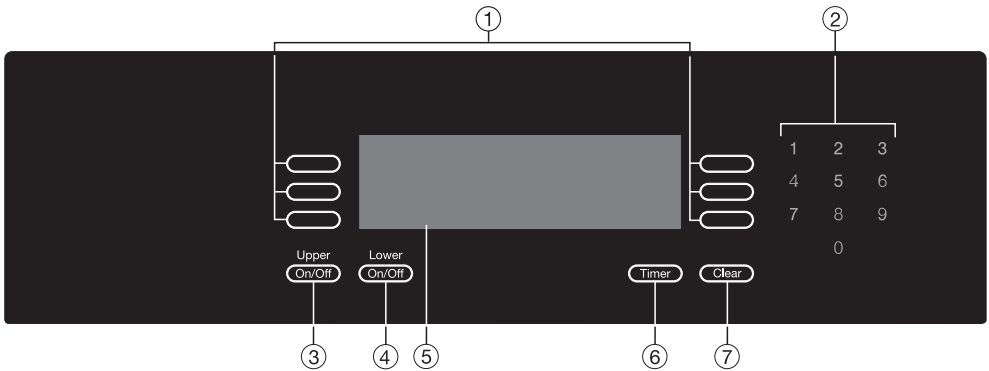

① **Touch controls**

to select or set a function.

② **Keypad**

to enter times or temperatures.

③ **"Upper On/Off" touch control**

to turn the upper oven on and off.

④ **"Lower On/Off" touch control**

to turn the lower oven on and off.

⑤ **Display**

shows the time or the functions.

⑥ **"Timer" touch control**

to set a timer independent of an oven function.

⑦ **"Clear" touch control**

to delete the last entry or to clear menu items.

Guide to the display

The "Upper On/Off" touch control, displays:



The "Lower On/Off" touch control, displays:



When both ovens are in use, the display will split to indicate the status of each oven.

The "▲" arrow points to the settings of the upper oven, the "▼" arrow to the lower oven settings.

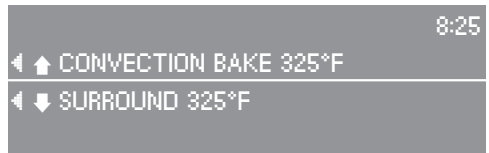

Wire rack

The racks are to be slid into the runners on either side of the oven. They have non-tip safety notches which prevent them from being pulled out completely while the oven is in use.

When inserting a rack, always check that the safety notches are at the rear of the oven.

The rack can only be removed by raising it upwards and then pulling out.

The wire racks are coated with PerfectClean and can be easily cleaned with a sponge and dish soap.

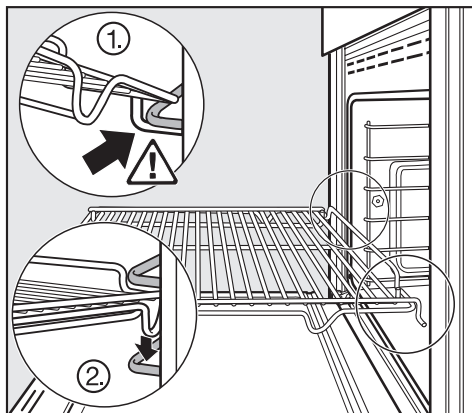

Roasting pan

The roasting pan is ideal for catching drippings from meat or poultry roasted or broiled directly on the rack. Slide the roasting pan onto the rail below the wire rack. See illustration.

It can also be used as a baking tray.

The roasting pan is coated with PerfectClean enamel and can be easily cleaned with a sponge and dish soap.

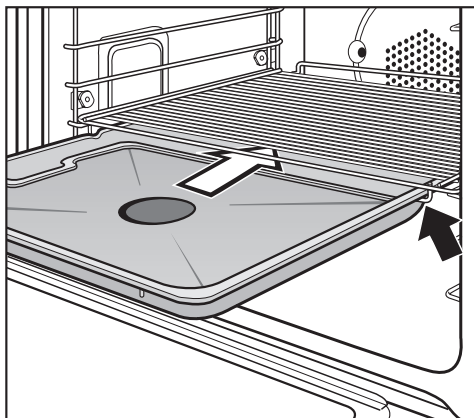

Oven accessories

Roast probe

The roast probe reliably monitors the core temperature of meat and poultry during a roasting function.

The long pointed end of the probe is inserted into the thickest portion of the meat while the short end of the probe is inserted into the roast probe socket.

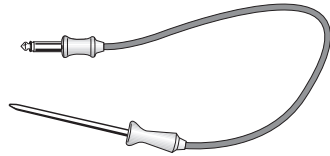

Rotisserie

The rotisserie evenly broils and adds a finishing touch to items such as stuffed meat, ties roasts, poultry, and kebabs by gently turning the skewers during the broiling function.

The skewers are inserted into the rotisserie motors in the back panel.

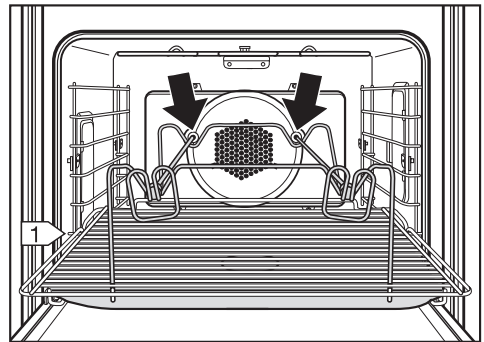

Slide opener

The slide opener is used to remove the light cover when changing a light bulb.

The flat end of the slide opener is wedged beneath the light cover to pry it off.

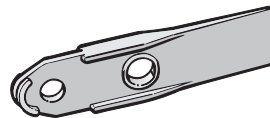

System lock

The oven is supplied with this setting deactivated as standard.
To use it you first have to activate it.

The system lock can be activated to prevent children from operating the oven or to conserve standby power when the oven will not be used for some time (e.g. vacation).

If activated the  symbol will show in the display when the oven is switched off.

To activate the system lock:

- Touch the "On/Off" control to activate the display.
- Call up the menu SETTINGS .
- Call up the submenu SYSTEM LOCK.
- Select the touch control next to "Accept" and confirm by touching "OK".
- Touch the "On/Off" control.

 is displayed at the right side of the display.

To deactivate the system lock:

- Call up the submenu SYSTEM LOCK.
- Select the touch control next to "Do not accept" and confirm by touching "OK".

Using the system lock:

- Select the touch control next to  and confirm "On".

The oven cannot be operated now.

The  symbol indicates that the lock has been activated. The timer can still be used while the lock is on.

The system lock remains active even after a power failure.

To switch the system lock off, call up  and confirm "Off".

The oven can now be used.

Note: If the system lock is activated for more than 4 days, the oven clock will have to be reset.

Using the oven display

This oven uses soft key technology and an LCD display to assist in the selection of functions.

To select a function, touch the control next to the desired function. The arrow next to each displayed function points to its corresponding control.

- Touch the "On/Off" control to activate the display.

Additional functions are displayed by touching the "more" control.



The previous display can be recalled by touching the "back" control.



Dots after a function indicate a submenu.

The submenu will appear when the function is selected.



The default oven settings can be changed in the function "SETTINGS 🏠". In this function you can customize the oven to suit your preferences. Settings may be adjusted by touching the appropriate touch control.

Available settings:



SETTINGS

Language 🚩

- Select the touch control next to the desired language and confirm by touching "OK".

The 🚩 symbol indicates the "Language" setting. If you accidentally select an unfamiliar language, simply look for the 🚩 symbol. Touch the control next to the flag symbol and select your language of choice.

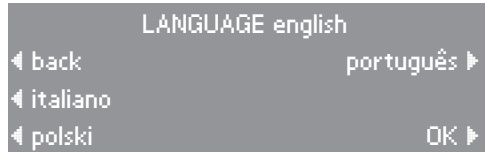
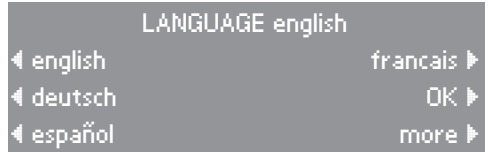

Clock

"Enter Time" appears in the display.

- Enter the current time using the keypad.

Different settings can be selected by touching the control next to the option:

- the size of the clock display,
Size Normal
Size Large
 - the time format,
12 hour
24 hour
 - whether or not the time is displayed,
Clock display On
Clock display Off
- Touch the "OK" control to confirm the entries.

If power to the oven is off for more than 4 days, the clock will have to be reset.

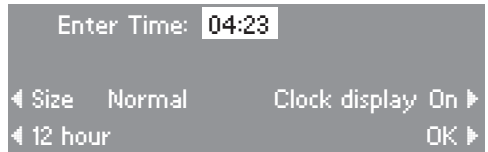

Temperatures

The default temperature of each function can be adjusted within the range shown below. If a temperature out of the range is selected, the oven will revert to the default temperature.

TEMPERATURES			
◀ BAKE	375°F		
◀ CONVECTION BAKE	325°F	OK ▶	
◀ SURROUND BAKE	375°F		more ▶

- Touch the control of the function whose default temperature you wish to alter.
- Enter the new default temperature using the keypad.

The next time this function is selected, the new temperature will be used.

Function	°F		°C	
	default	range	default	range
Bake	375 °F	200-500 °F	190 °C	100-260 °C
Convection Bake	325 °F	125-500 °F	160 °C	50-260 °C
Surround Bake	375 °F	125-550 °F	190 °C	50-290 °C
Browning	375 °F	200-500 °F	190 °C	100-260 °C
Intensive	325 °F	200-500 °F	160 °C	100-260 °C
Auto Roast	325 °F	200-425 °F	160 °C	100-210 °C
Convection Roast	325 °F	125-500 °F	160 °C	50-260 °C
Surround Roast	400 °F	175-550 °F	200 °C	80-290 °C
Broil	no default	400-575 °F	no default	200-300 °C
Maxi Broil	no default	400-575 °F	no default	200-300 °C
Convection Broil	no default	200-500 °F	no default	100-260 °C
Rotisserie	no default	400-575 °F	no default	200-300 °C
Defrost	75 °F	75-125 °F	25 °C	25-50 °C
Sabbath Bake	375 °F	200-500 °F	190 °C	100-260 °C
Sabbath Surround	375 °F	125-550 °F	190 °C	50-290 °C

SETTINGS

Oven Light

The "on" duration of the oven light can be altered.

- Touch the control of the light setting you wish to choose.
- "Off after 1 minute"
The light goes off after the first minute of a function.
- "On during use"
The oven light remains lit during a function.

The selected setting will appear in the display.

- Touch the "OK" control to confirm the selection.

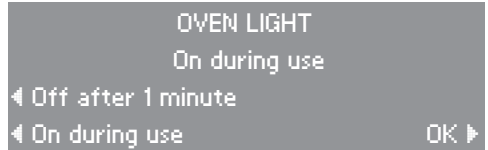

Temperature °F / °C

All oven temperatures can be displayed in either Fahrenheit or Celsius degrees.

- Touch the "TEMPERATURE" control to toggle between °F and °C.



Tone Options

Unique tones may be set for each of the two timers to differentiate the timers from an oven function tone.

"Timer 1" and "Timer 2"

The tone of Timer 1 and Timer 2 can be set to one of five tone options.

- Select "Timer 1 Tone" or "Timer 2 Tone" by touching the corresponding control.

With every touch of the respective control, another tone will sound and the display will show the tone number.

- Select the tone for each timer.

"Keypad tone"

The keypad can be set to make a sound with every touch of a control.

- Touch the "Keypad tone" control to toggle between the "On" and "Off" settings.

"Volume"

This control adjusts the volume of the tone options.

- Touch the "Volume" control until you hear the desired volume.

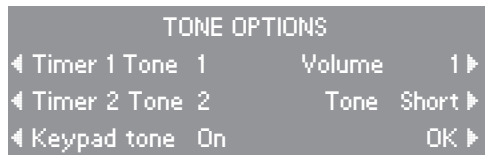

SETTINGS

"Tone Short / Long"

The duration of the timer and oven tones can be modified.

- "Tone short" will beep in quick succession when an oven signal or the oven timer sounds.
- "Tone long", a continuous tone will sound when an oven signal or the oven timer sounds.
- Touch the "Tone" control to toggle between the short and long setting.
- Touch the "OK" control to confirm the "TONE OPTIONS" settings.

When the tone sounds to indicate an oven signal or the timer, touch any number on the keypad to turn off the tone.

Display

The brightness and contrast of the oven display can be adjusted by touching the controls next to "Brightness" and "Contrast".

Reset

The factory settings of the oven can be restored through the "RESET" function.

- Temperatures
- Settings
- Favorites



Reset Temperatures

If the request is confirmed with "Yes", all changed temperatures will be restored to the factory default.

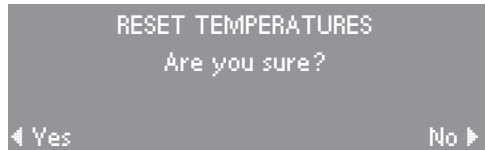

Reset Settings

If the request is confirmed with "Yes", all changed settings will be restored to the factory default.

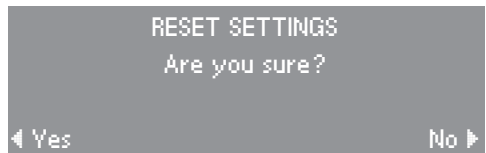

Reset Favorites

If the request is confirmed with "Yes", all "favorite" entries will be deleted. Once deleted, these entries cannot be restored.

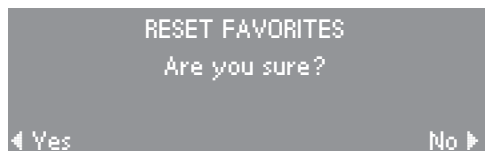

System lock

See chapter "Locking the oven".

Before using the oven

Heat the oven

New ovens may have a slight odor during the first few uses. To eliminate the odor quickly, the oven should be operated at a high temperature for 2 hours.

Before heating the oven for the first time remove (if present)

- any stickers from the baking tray, roasting pan or interior floor.
- any cork spacers from the ceiling of the interior.
- foil from the appliance front.

Make sure the room is well ventilated during this process.

■ Remove all accessories from the oven.

■ Touch the "On/Off" control.

■ Select the "BAKE" function.

■ Select "CONVECTION BAKE".

■ Select "Temperature".

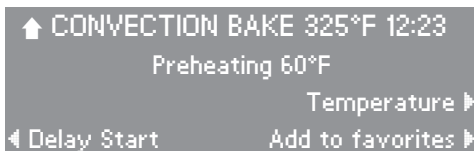
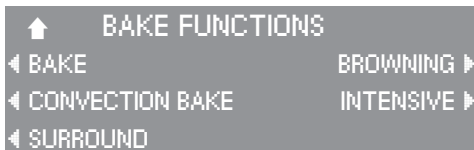

Before using the oven

- Set the temperature to 500 °F (260 °C) using the keypad.

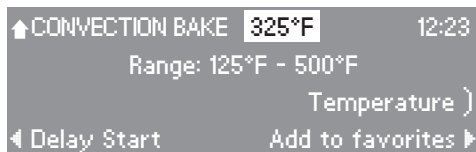

- Set the timer to run the oven for 2 hours by touching the "Delay Start" control.

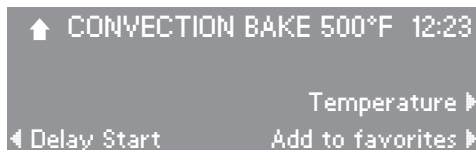

- Select "Duration". Set the duration by entering "2", "0", "0" using the keypad.
- Touch the "OK" control.

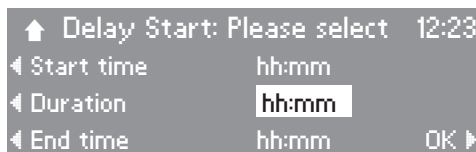

The oven will run for 2 hours and the count down will appear in the display.

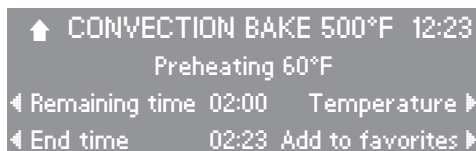

Using the oven

Selecting a function

- Touch the "On/Off" control to activate the display.
- Touch the control next to the function you wish to select.

For example, touch the control next to the word "BAKE" to select this function.

The "BAKE" function submenu will appear in the display.

- Touch the control next to the submenu function you wish to select.

For example, touch the control left of "CONVECTION BAKE".

The "CONVECTION BAKE" function will appear in the display.

The default temperature of 325 °F (160 °C) will be displayed next to the function name.

Adjusting the oven temperature

This oven has been factory tested for the optimum operating temperature of each function. This temperature can be adjusted if needed.

- Touch the "Temperature" control.

The temperature will be highlighted in the display.

- Enter the new temperature using the keypad.

The oven will heat to the adjusted temperature.

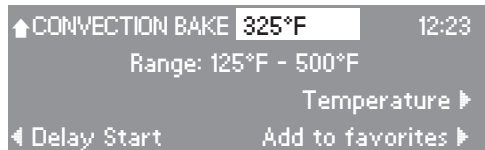
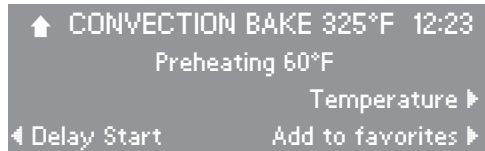
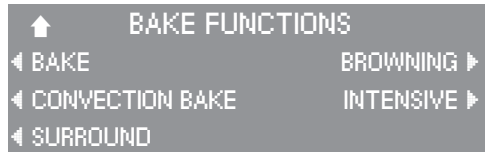

Preheating

For proper cooking results, most recipes call for a preheated oven.

After a temperature has been selected, the rising temperature can be viewed in the display.

"Preheating" will show in the display until the oven has reached the selected temperature.

A tone will sound once the oven has finished preheating.

- Place the food in the oven once the temperature has been reached.

The oven should **not** be preheated when using "AUTO ROAST".

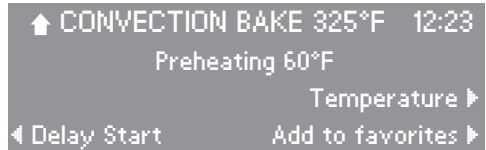

Using the oven

Delay Start

This function allows you to turn cooking processes automatically off or on and off.

Duration

To enter the cooking time. After this time has elapsed the oven turns off automatically. The maximum duration time which can be entered is 11 hours 59 minutes.

- Touch the "Delay Start" control.
- Touch the "Duration" control and enter the cooking time.
- Confirm the entries by touching the "OK" control or cancel by touching "Clear".

For example, enter "00:50" and the function will run for 50 minutes.

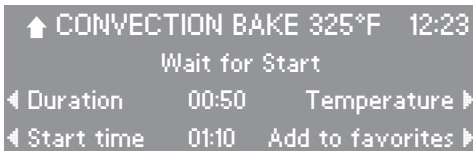
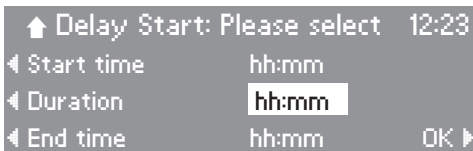

Start time

This feature allows you to delay the start of a function, from 1 minute to 23 hours 59 minutes, so that the cooking process begins at a specified time.

- Touch the "Delay Start" control.
- Touch the "Start time" control and enter the start time.

For example, enter "01:10" and the oven will start cooking at 1:10.

- Touch the "Duration" control and enter the cooking time.

For example, enter "00:50" and the function will run for 50 minutes.

The "duration" must be entered for this feature to operate correctly.

- Confirm the entries by touching the "OK" control or cancel by touching "Clear".

The end time will automatically be calculated.

End time

The desired end time allows you to set the actual time you would like cooking to complete. This time is limited to 24 hours from the current time.

- Touch the "Delay Start" control.
- Touch the "End time" control and enter the desired end time.

For example, enter "02:15" and the oven will finish cooking at 2:15.

- Touch the "Duration" control and enter the cooking time.

For example, "01:30" for 1 hour and 30 minutes.

If a duration time is entered, a delay start time will automatically be calculated.

If no duration time is entered, the oven will calculate a duration based on the current time.

- Confirm the entry by touching the "OK" control or cancel by touching "Clear".

Using the oven

Canceling a process

- Touch the "Clear" control.
- Select the option you wish to cancel.

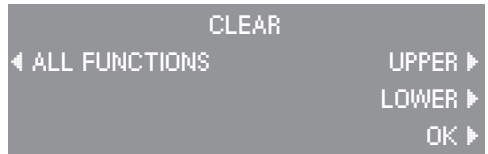

Turning off the oven

- Touch the "On/Off" control.

The oven will turn off and the time of day will appear in the display.

At the end of cooking

- a tone will sound,
- "Ready" will appear in the display under the function name, and
- the oven will shut off automatically.

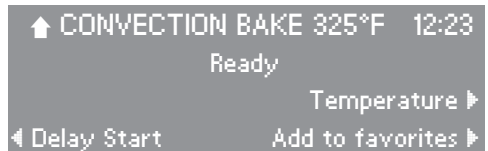

Setting a timer

The timer can be used to time any activity in the kitchen and can be set independently of a cooking function.

Two alarms (Timer 1 and 2) can be selected simultaneously.

A maximum time of 99 minutes and 59 seconds can be selected.

To set a timer:

- Touch the "Timer" control.
- Use the keypad to enter the desired time in minutes and seconds.

The second timer can be set in the same way as the first.

The count down of Timer 1 and 2 is shown in the lower area of the display.

At the end of the timed period, a tone will sound.

- Touch "Clear" to cancel the timer tone.

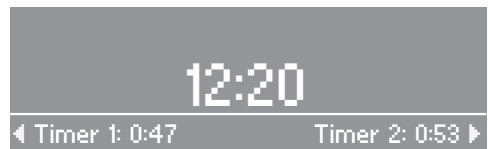
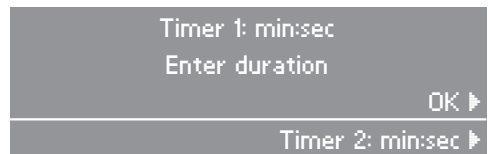

To cancel the timer

- Touch the "Clear" control.
- Touch the control for the timer to be canceled or to cancel both timers and a running function touch "ALL FUNCTIONS".
- Touch "OK".

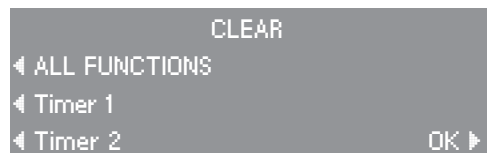



Guide to the functions

BAKE

Baking tips

The roasting pan does not need to be greased or covered with parchment paper. The PerfectClean enamel finish prevents spillovers from baking onto and into the surface. Baked food can be easily removed.

Use baking parchment only for dough with a high egg white content, i.e. for biscuit, meringue or macaroons.

BAKE

Default temperature . . . 375 °F (190 °C)

The "BAKE" function works by heating food from below. This is similar to the "bake mode" of a conventional oven.

Use this function for:

- boxed cake mixes,
- baked apples,
- frozen dinners.

The recommended positions are the 2nd or 3rd runners from the bottom.

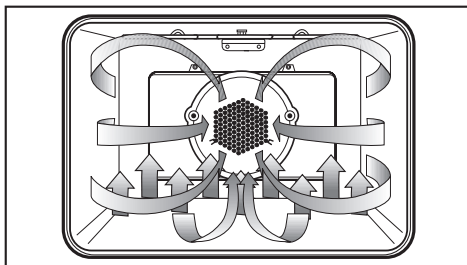

BAKE

CONVECTION BAKE

Default temperature . . . 325 °F (160 °C)

This function actively circulates heated air throughout the oven cavity for a consistent baking temperature.

Use this function for:

- cookies, cakes,
- quick breads,
- yeast breads,
- cheesecakes,
- pies, quiche,
- baked potatoes,
- casseroles.

When using the convection function, several runner levels can be used at the same time.

The recommended positions are:

1 tray = 1st runner from the bottom
Exception: Place cookies on the 3^d runner from the bottom.

2 trays = 1st and 4th runners from the bottom

3 trays = 1st, 3^d and 5th runners from the bottom

When baking 3 trays of cookies or small cakes at the same time, remove the respective tray when the desired browning is reached.

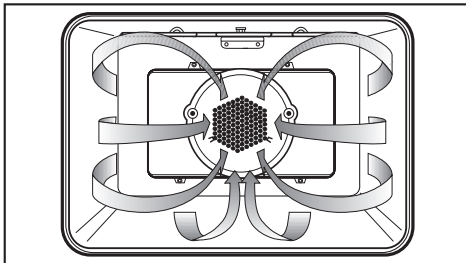

As a general rule, the temperature of a recipe not designed for baking in a convection oven should be lowered by 25 °F (15 °C.)

SURROUND

Default temperature . . . 375 °F (190 °C)

The "SURROUND" function is a premium conventional baking mode. The oven heats with both the upper and lower heating elements without the convection fan.

Use this function for:

- souffles, meringues,
- angel food cakes,
- cream puffs,
- cookies, cakes,
- cheesecakes,
- pies, quiche,
- baked potatoes.

The recommended positions are the 1st or 2nd runners from the bottom.

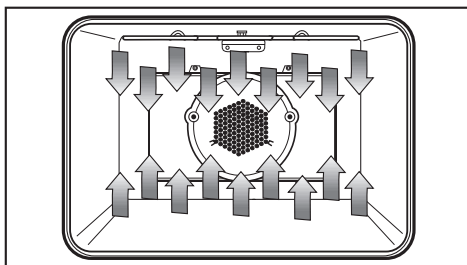

BROWNING

Default temperature . . . 375 °F (190 °C)

In the "BROWNING" function, food is heated from above.

Use this function for:

- browning meringue,
- melting a cheese topping,
- caramelizing a sugar topping as in crème brûlée.

The recommended position is the 4th runner from the bottom.

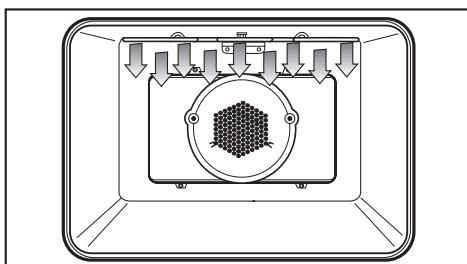

BAKE

INTENSIVE

Default temperature . . . 325 °F (160 °C)

The "INTENSIVE" function generates heat from the lower heating element. The oven's fan gently circulates the heated air to create a brick oven (convection) environment.

Use this function for:

- pizza,
- focaccia,
- stromboli.

Use the 1st runner from the bottom. Should the bottom of the food burn, raise the rack to a higher runner.

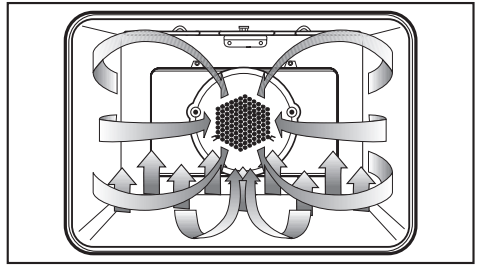

When using "INTENSIVE", recipe temperatures should be lowered by 25 °F (15 °C).

Intensive is not recommended for roasting or shallow baking.

Do not bake on the oven floor.

AUTO ROAST

Default temperature . . . 325 °F (160 °C)

This premium convection function heats the oven to a high temperature to sear the meat, retaining moisture and tenderness.

"Searing" appears in the display. Once the meat is seared, the function returns to the selected temperature and "Searing" is no longer shown.

Use this function for:

- poultry (whole birds),
- roasts, e.g. prime rib, pork loin, beef tenderloin, leg of lamb, etc.

The recommended position is the 1st runner from the bottom.

The oven should not be preheated when using "AUTO ROAST".

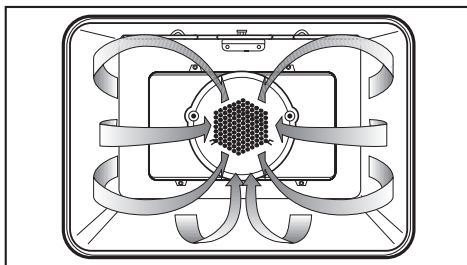

ROAST

CONVECTION ROAST

Default temperature . . . 325 °F (160 °C)

This function uses the convection fan to actively circulate heated air throughout the oven.

This function does not spike the oven temperature for searing.

Use this function for:

- chicken pieces,
- small cuts of meat,
- fish,
- salmon, lobster tails,
- meat loaf.

The recommended position is the 1st runner from the bottom.

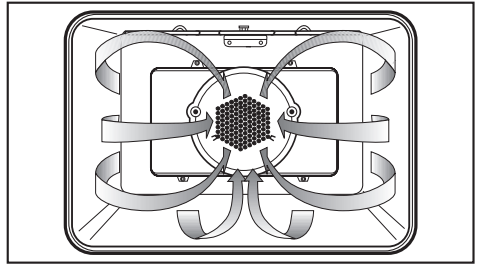

SURROUND ROAST

Default temperature . . . 400 °F (200 °C)

"SURROUND ROAST" is a conventional roasting program for traditional recipes.

Use this function for:

- pot roast,
- brisket,
- stew.

The recommended position is the 2nd runner from the bottom.

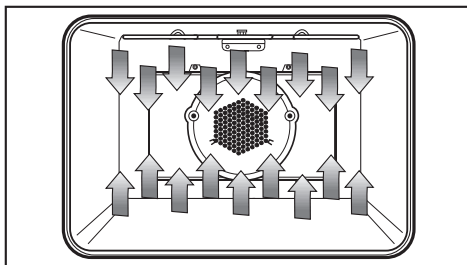

ROAST

Roasting tips

- The larger the cut of meat to be roasted, the lower the temperature should be.

The roasting process will take a little longer, but the meat will be cooked evenly and the outside will become crisp.

- Use the roast probe for accurate cooking temperatures and best results.

Roasting in a covered pot

When roasting in a covered pot, increase the recipe temperature by 70 °F (20 °C).

Season the meat and place it in the pot. Add some butter, margarine or a little oil and about ½ cup of water when roasting a large piece of meat or roasting poultry with a high fat content.

Roasting on the rack

Use the rack with the roasting pan inserted below. Add a little oil to very lean meat or place a few strips of bacon on top to help retain moisture. Place a little water in the roasting pan below the meat to catch drippings.

Roasting poultry

For crispy skin, baste poultry ten minutes before the end of cooking with salt water.

Using the roast probe

The roast probe reliably monitors the roasting process. The tip of the probe continuously measures the core temperature of the meat or poultry.

When the selected core temperature is reached, the oven automatically shuts off.

The roast probe can be used with the following functions:

- AUTO ROAST
- CONVECTION ROAST
- SURROUND ROAST
- CONVECTION BROIL

Using the roast probe:

- Prepare the meat as usual (in a pot or on the rack).

Roasting bags or aluminum foil may be used, but only when left open at the end. Insert the probe into the meat or poultry through the opened end of the foil or bag.

- Insert the probe into the middle of the meat. Make sure that the probe does not touch any bones and is not located in a fatty portion of the meat. Improper insertion of the probe could shut the oven off too early.

- Put the meat into the oven.

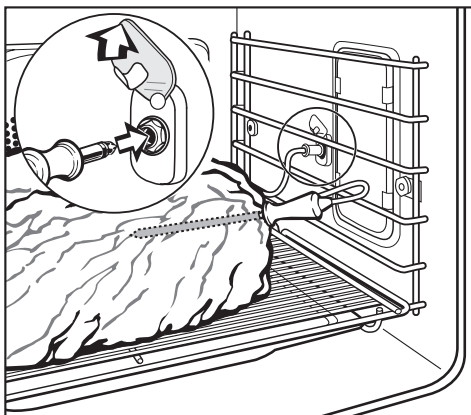

ROAST

When roasting poultry, the best place to insert the probe is in the thickest part of the bird between the thigh and body.

- Insert the short end of the roast probe into the socket on the right side of the oven so it clicks into place.

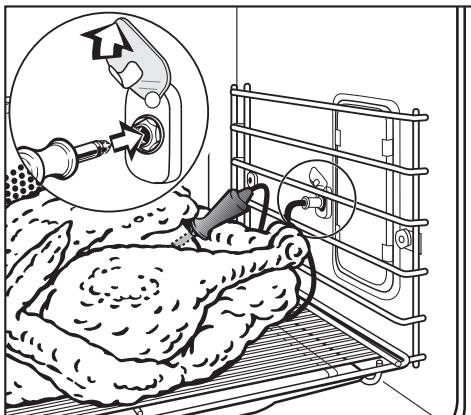

- Select a roasting function.

For example, "AUTO ROAST".

The default temperature and the probe (core) temperature, once inserted, will show in the oven display.

To adjust the core temperature:

- Touch the control to the left of "Roast probe".
- Enter the new core temperature using the keypad.

The start of roasting can also be delayed at this time.

- Touch the "Delayed Start" control.

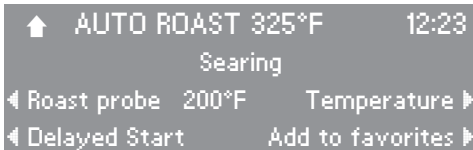
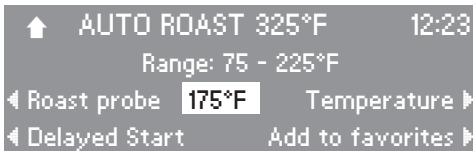
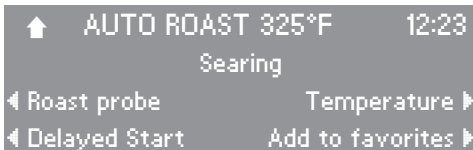

- Enter the Start time of the roasting process using the keypad.

At the end of cooking, when the selected core temperature has been reached, a tone will sound.

The tone can be canceled by touching "Clear".



Please note:

When finished, cover the meat with aluminum foil and allow to stand for 10 minutes. During this time, the core temperature will rise 5 - 10 degrees.

If the temperature probe is left in the food at the end of the cooking process, the oven display will show the core temperature first increasing and then decreasing.

MASTER CHEF

The "MASTER CHEF" function contains an easy to use list of preset functions of commonly cooked foods such as pizza, chicken and french fries.

- Touch the "MASTER CHEF" control to view the list of preset functions.
- Touch the control of the function you wish to select.

For example, to cook a 12 lb turkey you would select "POULTRY".

- Touch the control to the left of "Turkey".

- Touch the control that corresponds to the weight of the turkey, "10 - 15 lb".
- Insert the roast probe into the turkey and into the roast probe socket, as prompted.
- The remaining cooking time can be monitored in the display.

To view the settings of a "MASTER CHEF" function, touch the control for "Cooking Mode".

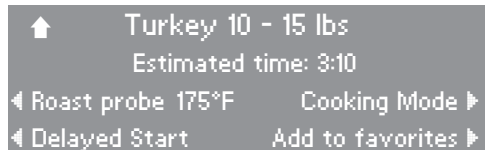
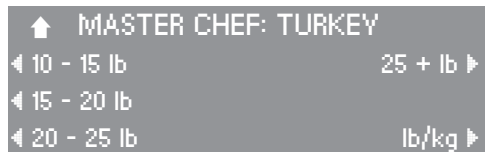
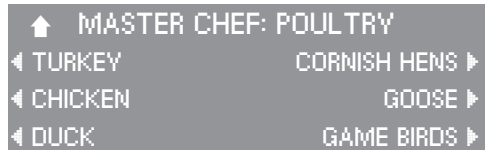
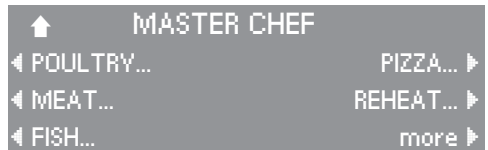

Tips for use

- To end an automatic program prematurely, turn the oven off.
- If the food is not cooked to your desire after an automatic program has elapsed, set the oven to Convection Bake 320 °F (160 °C) and cook or brown it for a few more minutes.
- After use let the oven cool to room temperature before using it again for an automatic program.
- When cooking poultry like goose or turkey, set the weight of the unstuffed poultry.
When cooking more than one chicken at once, set the weight of the heavier chicken (not the total weight).
- During some programs the oven must be preheated before inserting the food into the oven. The respective info and time indication will show in the display.
- Automatic programs can be saved as "Favorites".

MASTER CHEF

MASTER CHEF Functions

POULTRY

Turkey

- 10 - 15 lb
- 15 - 20 lb
- 20 - 25 lb
- 25 + lb

Chicken

- Cordon Bleu
- Whole: 0 - 5 lb
- Whole: 5 + lb
- Cutlets
- Parts

Duck

- 3 - 5 lb
- 5 + lb

Cornish Hens

- 1 - 2 lb

Goose

- 5 - 10 lb
- 10 - 15 lb

Game birds

- 0 - 2 lb
- 2 - 4 lb

MEAT

Beef

- Roast
- Prime Rib
- Pot Roast
- Steak
- London Broil

Pork

- Loin Roast
- Blade Roast
- Crown Roast
- Cooked Ham
- Natural Ham
- Chops

Veal

- Rolled Roast
- Loin Roast
- Rib Roast
- Chops

Lamb

- Leg
- Rack
- Half Shank
- Half Sirloin

FISH

Steaks

- Fillets
- Whole
- Lobster Tails
- Paella
- Shrimp

PIZZA

- Fresh
- Frozen
- Self-rising
- Stromboli
- Calzone

REHEAT

- Pizza
- Banquet Pan
- Casserole

BAKED GOODS

- Fruit Pies
- Layer Cake
- Cookies
- Soufflé
- Sponge Cake
- Muffins

POTATOES

- Baked
- French Fries

BROIL

No default temperature

Only the inner part of the upper heating element is used for a smaller area of intense heat from above. This function is excellent for broiling or searing small quantities.

Use this function for:

- chops, ribs
- small quantities of meat,
- browning small dishes.

The recommended position is the 4th runner from the bottom.

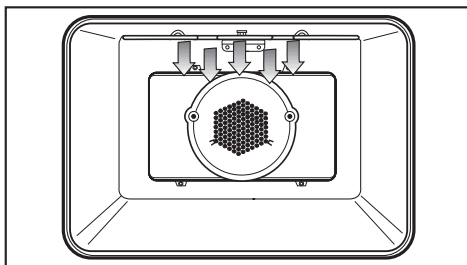

BROIL

MAXI BROIL

No default temperature

The entire upper heating element is used for intense heating from above. This function gives excellent browning and searing results.

Use this function for:

- chops, ribs
- large quantities of meat,
- browning large dishes.

The recommended position is the 4th runner from the bottom.

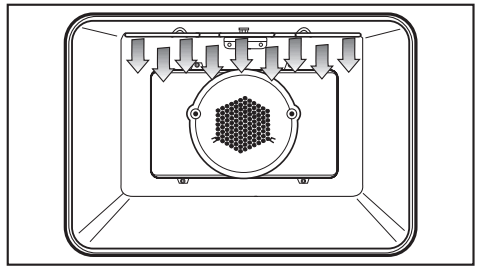

CONVECTION BROIL

No default temperature

Hot air from the upper heating element is distributed over the food by the fan. This enables a lower temperature than conventional broiling to be used.

Use this function for:

- thick pieces of meat,
- London broil.

The recommended position is the 3rd runner from the bottom.

The roast probe can be used in this function to monitor the meat's core temperature. Refer to "ROAST/ Using the roast probe" for more information.

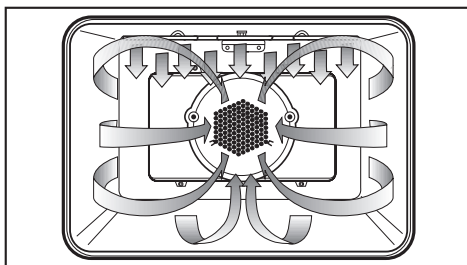

BROIL

ROTISSERIE

No default temperature

This function is only available in the upper oven.

The "ROTISSERIE" function broils meat or poultry while turning it on a spit for even cooking results.

Use this function for:

- poultry, whole birds,
- tied roast, e.g. pork loin, beef tenderloin, etc.,
- kebabs.

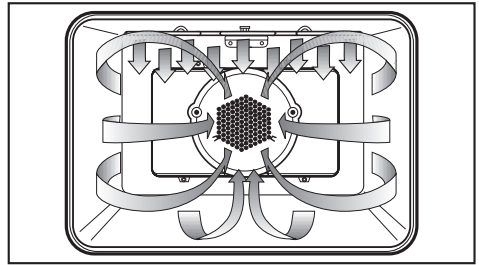

The roast probe cannot be used at the same time as the rotisserie. The cable could wind around the rotisserie and be damaged.

- Secure meat or poultry on the skewers.
(Poultry legs should be tied together to prevent them from catching on the heating element or burning.)

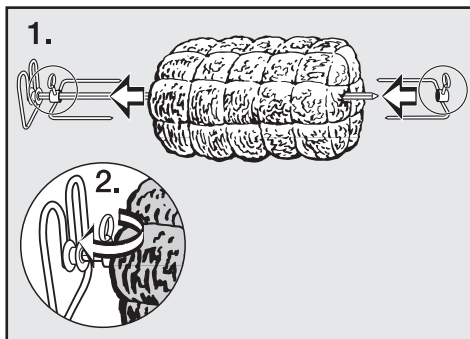

- Assemble the rotisserie as shown.

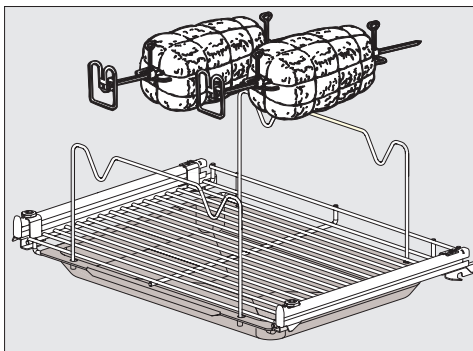

- Put the rotisserie in the oven, using the **lowest** level runner.
- Insert the spits into the grill motors at the back of the oven.
- Select "ROTISSERIE".

The spits will rotate.

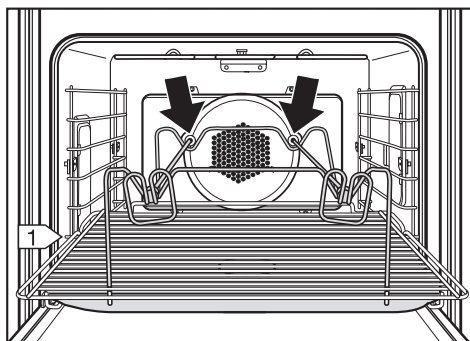

BROIL

Broiling tips

- To ensure even cooking, it is best to broil foods of a similar thickness at the same time. Most items should be turned halfway through broiling.
- To determine how far through a thick piece of meat has been cooked, press down on its surface with a spoon.

If the surface presses down easily and with little resistance to the spoon, it is "rare".

If there is some resistance, it is "medium".

If there is great resistance, it is "well done".

If you often cook a recipe with the same settings (function, time, temperature) you can save them as a "favorite" for easy recall.

To save a favorite:

- Enter the function, temperature and cooking times of the recipe.
The oven will begin heating.

- Touch the "Add to favorites" control.

Your "favorite" must be named before it can be saved to the memory.

- Enter the letters and numbers of the name by touching the controls left and right of the alpha-numeric list. Confirm each character entry by touching the "Select" control.

- Touch the "Save" control when naming is complete to save the "favorite" to memory.

Your "favorite" can now be recalled from the "FAVORITES" list. When selected the oven will automatically use the saved settings.

- Touch "Clear" to cancel the running function if you are not cooking.

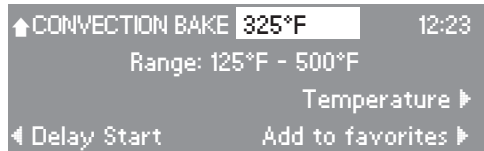

SABBATH

SABBATH

Default temperature . . . 375 °F (190 °C)

For religious observance, the oven can be set to run for the duration of the Sabbath. There will be no visual change to the control panel and the clock will not be displayed.

In this function, only "BAKE" and "SURROUND" are available.

- Select the desired Sabbath function while the door is closed.
- Adjust the oven temperature by using the "Temperature" control.
- Start the process by using the "Start" control.

The oven will stay in "Hold" mode until the oven door is reopened.

- Open the oven door.
- Place the food in the oven.
- Close the oven door.

After a 5 minute delay, the oven will start heating until the set temperature is reached. This temperature will be held constant for 72 hours.

If Sabbath is selected in either oven, the other oven can only be operated with the Sabbath function. Once the Sabbath function has started the settings can not be changed. The oven can only be turned off with the "On/Off" control.

At the end of Sabbath

After 72 hours, the oven will shut off and "Fault 55" will appear in the display.

- Turn the oven off to reset it to normal operation.

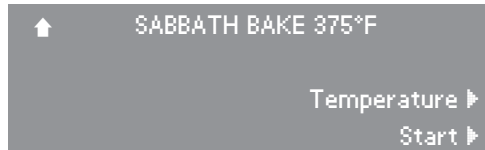

DEHYDRATE

Default temperature 175 °F (80 °C)

This function is for dehydrating fruits, vegetables and herbs.

A consistent low temperature and the fan maintain the ideal conditions for the long dehydration process.

For best results, blot food with a paper towel before dehydrating.

Foods to be dehydrated should be placed directly on the oven racks or on a drying screen (not supplied with oven).

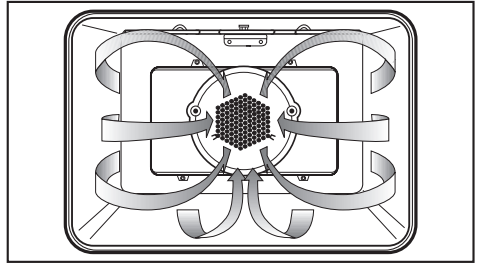

PROOF

PROOF

Default temperature:

Light batter 125 °F (50 °C)

Dense batter 110 °F (43 °C)

The warm environment created in the proof function will allow you to effectively proof dough. This function maintains a low temperature perfect for yeast to rise.

Place the dough in a large bowl on the oven rack positioned at the lowest runner level. Keep the oven door closed during this process.

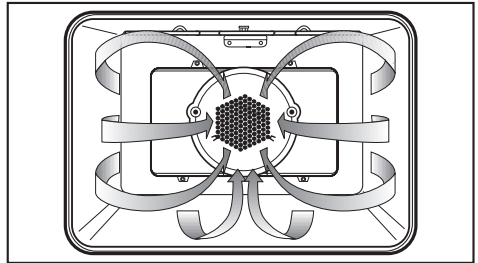

DEFROST

Default temperature 75 °F (25 °C)

This function allows you to defrost food at a constant temperature.

Defrosting times depend on the type and weight of the food, and at what temperature it was deep-frozen.

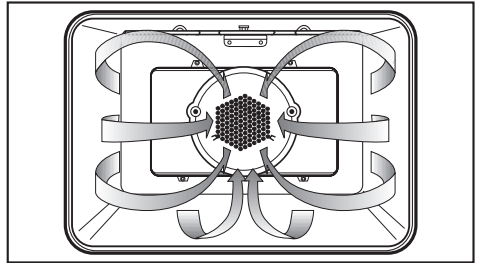

Defrosting tips

- Remove the frozen food from the packaging and place it in the roasting pan or into an appropriate dish.
- Meat and poultry should be fully thawed before cooking. Do not use the liquids from defrosting.
- Fish does not need to be fully defrosted before cooking. Defrost so that the surface is soft enough to absorb herbs and seasoning.
- Cook all food immediately after defrosting.

Cleaning and care

Front of appliance

It is best to clean spills from the front of the appliance immediately. Spills that remain longer may cause the surface to become discolored or changed.

All surfaces are vulnerable to scratching. Scratches can lead to shattering of the glass surface. All surfaces can become discolored or changed if they come into contact with unsuitable cleaning agents.

- Clean the front of the appliance with a clean sponge or cloth, liquid dish soap and warm water, or a clean, damp micro fiber cloth. Then dry with a soft cloth.

Glass cleaners **may be used** to clean the exterior. However **do not** allow them to sit or "puddle", this can cause damage to the surface.

Remove the cleaner promptly.

To better maintain your appliance avoid the following:

- cleaning products that contain washing soda, ammonia, acids, or chlorine
- lime removers
- scouring cleansers, e.g., scouring powder, scouring liquid, pumice stones
- solvent-based cleansers
- stainless steel cleaners
- dishwasher detergents
- oven sprays
- scouring sponges or brushes, e.g. pot scrubbers
- sharp metal scrapers

Accessories

Roast probe

Wash with soapy water and a sponge. Rinse under running water.

Do not submerge the roast probe in water. Do not clean the roast probe in the dishwasher.

Rotisserie

Clean with liquid dish soap and hot water, or in the dishwasher.

PerfectClean

The revolutionary PerfectClean enamel is a smooth, nonstick surface that cleans easily with a sponge.

The following have been treated with "PerfectClean":

- roasting pan,
- wire rack.

- Do not clean items with PerfectClean in a dishwasher. Dishwasher detergents may damage the enamel.
- Clean after each use with a sponge and a solution of hot water and liquid dish soap.
- Do not use abrasive cleaners, ceramic cleaners, metal scourers, or oven cleaners on PerfectClean surfaces.
- After cleaning, rinse thoroughly with water. The water should run off the surface easily, any residue will hinder this effect.
- Stubborn baked on grease may need to be soaked first to loosen deposits.
- Clean up spills on PerfectClean surfaces as soon as possible to prevent stains.
- Spilled fruit juices may permanently discolor surfaces. This discoloration is permanent but will not affect the efficiency of the enamel.

Cleaning and care

Cleaning the oven cavity by hand

 Danger of burns! Allow the oven to cool before cleaning.

To make cleaning easier

- remove the oven door,
 - remove the runners,
 - lower the upper heating element.
- Clean the oven surfaces with a solution of hot water, liquid dish soap and a sponge or soft nylon brush.

Do not use abrasive cleaning agents, hard brushes, metal scouring pads, steel wool, knives or other abrasive materials.

Avoid cleaning the gasket around the interior (sealing the door glass pane).
It is made from glass fiber and will get damaged if rubbed or scrubbed.

Do not use oven sprays on any part of this oven.

- Dry surfaces before reassembly.

Removing the oven door

Please note: The oven door is quite heavy. It should be gripped firmly at the sides when being removed or refitted.

- Open the door fully.
- Flip up the locking clamps on each door hinge.



- Slowly shut the door until the protruding clamps stop the movement. Pull the door upward. See illustration.

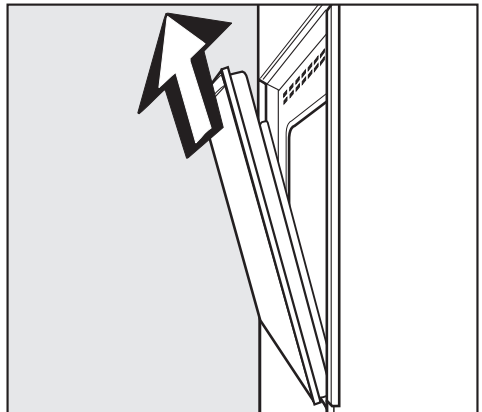

Cleaning and care

Refitting the oven door

- Insert the door onto the hinges and open the door completely.
- Flip the locking clamps down.

Be sure that the locking clamps are flipped down when the door is reinstalled. Otherwise, on closing the door, the hinges could work loose from the guide holes and cause damage.

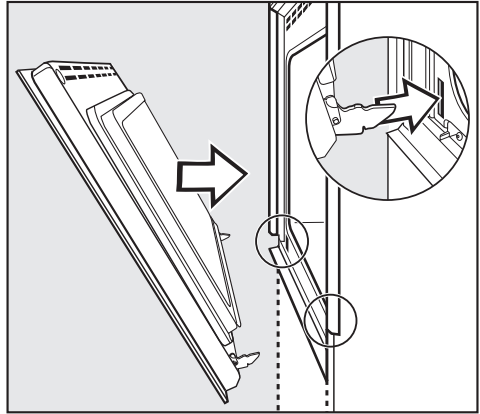

Removing the runners

- Turn the two screws, ①, counterclockwise and remove.
- Remove the runners, ②, from the oven by pulling them away from the oven wall.

Reassemble in the reverse order, ensuring all parts are correctly in place.

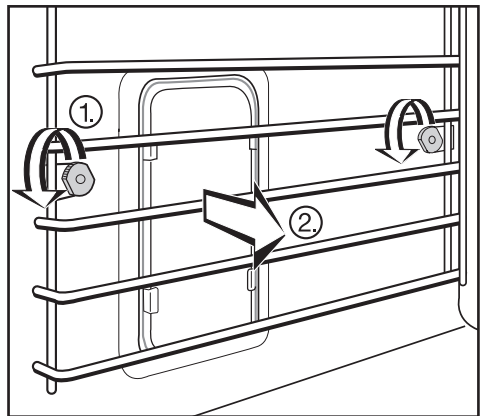

Lowering the upper heating element

- First remove the runners.
- Loosen the wing nut.

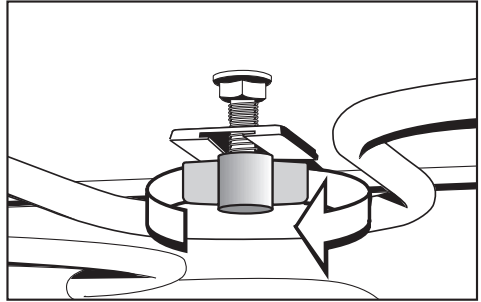

- **Gently** lower the upper heating element.

Do not use force to lower it, as this could cause damage.

- Reassemble in the reverse order, ensuring all parts are correctly in place.

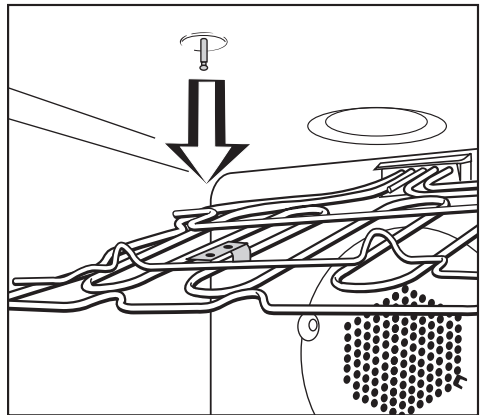

Self Cleaning

SELF CLEAN function

In the self cleaning function, the oven is heated to very high temperatures burning off any residue on the oven interior.

The duration of the "SELF CLEAN" function will depend on the amount of soiling in the oven.

After the cleaning process, any burnt off debris (e.g. ash) can be easily wiped out with a damp sponge.

If the oven is not cleaned regularly, debris may become extremely difficult to remove even with the "SELF CLEAN" function.

Spilled fruit juices may permanently discolor surfaces. This discoloration is permanent but will not affect the efficiency of the enamel.

Automatic door lock

Due to the extremely high temperatures reached in the self cleaning function, the door will lock automatically after the first minute of the function.

The lock releases once cleaning has ended and the oven temperature has dropped below 535 °F (280 °C).

If "SELF CLEAN" is accidentally selected, shut off the oven and wait for the oven temperature to drop and for the door lock to release.

Before starting the "SELF CLEAN" function:

- Remove large pieces of debris and any puddles of grease from the oven interior. Debris and grease can ignite at high temperatures.
- Remove all accessories, but the side runners, from the oven. The high temperatures of this function will damage the accessories.

- Touch the "SELF CLEAN" control.
- Touch the "Start" or "Delayed Start" control.

"Start" will begin the function at once.

"Delayed Start" will begin the function once the entered delay time has elapsed.

When the function starts, the display shows "In Process" and the oven door will lock.

A tone will sound when the "SELF CLEAN" function has ended and "Ready" will appear in the display.

- **Once the oven has cooled**, remove the ash with a damp sponge.

Avoid cleaning the gasket around the interior (sealing the door glass pane). It is made from glass fiber and will get damaged if rubbed or scrubbed.

A film may build up on the oven door. This can be removed with a shielded blade scraper or a non-abrasive sponge and a mild solution of warm water and dish soap.

The "SELF CLEAN" function will stop,

- if the oven interior is extremely soiled. (Remove large pieces of debris and restart the function.)
- if the "Clear" control is touched.
- if the oven is shut off.
- if there is a power failure.

The display will show "Process interrupted".

The oven door will remain locked until the oven temperature has fallen below 535 °F (280 °C).

You can set the "SELF CLEAN" function for both ovens at the same time.

However, the cleaning process will run one after another. This means the oven which was programmed first, will be cleaned first.

The status of the cleaning process is shown in the display.

Changing the light bulb

 To reduce the risk of electric shock, disconnect this appliance from the power supply by shutting off the power main or tripping the circuit breaker.

Changing the light bulb

- Remove the runners.
- Spread a dishtowel on the oven floor to protect the enamel, in case the light cover falls.
- Insert the supplied slide opener between the light cover and the metal frame of the light along the edge closest to the oven door.
- Pry the light cover out of the metal frame.

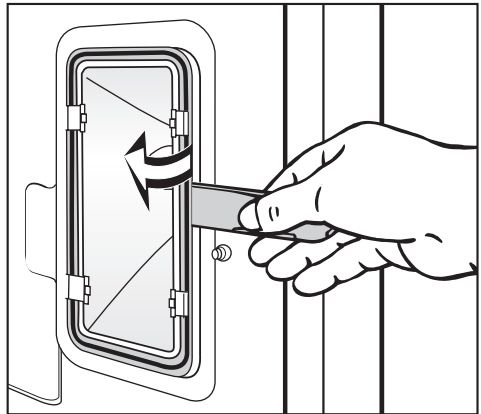

- Slide the light cover out of the two clamps secured to the metal frame.

Do not bend these metal clamps. The clamps and the reflector could be damaged.

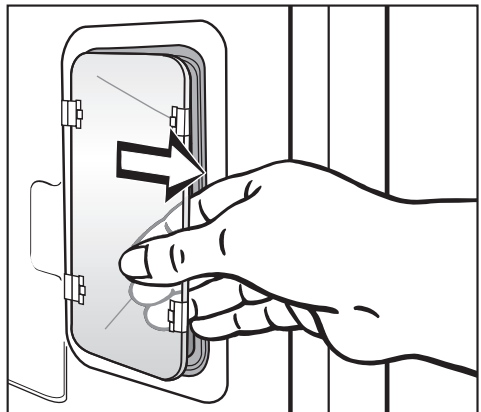

Changing the light bulb

- Replace the halogen bulb.

Only use the following light bulb:
12 V, 10 W, 572 °F (300 °C) heat
resistant, socket G4, type 64418
made by Osram.

Do not touch the new light bulb with
your fingers; touching the bulb will
reduce its life. Follow the bulb
manufacturer's instructions.

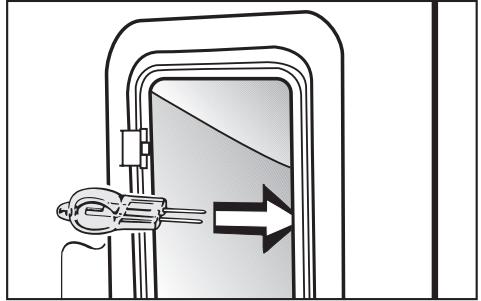

- Put the light cover back in place with
the notch to the rear of the metal
clamps.

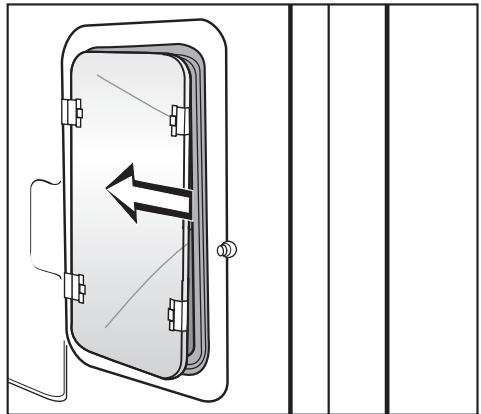

- Press the light cover into the metal
frame.

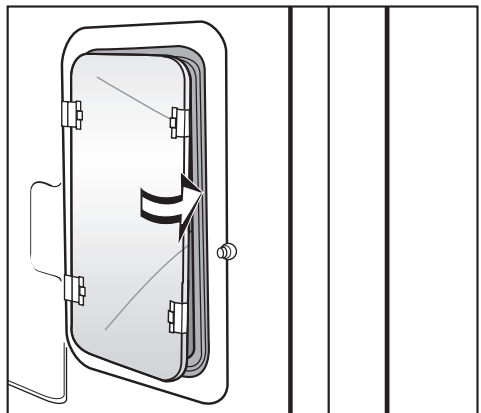

- Reassemble the runners.

Frequently asked questions

Repairs should only be carried out by a qualified and trained person in accordance with local and national safety regulations. Unauthorized repairs could cause personal injury or machine damage.

What if the oven does not heat?

Possible fault	Solution
The system lock is activated.	Deactivate the system lock.
The circuit breaker has tripped.	Check the breaker.
The delay start has been set.	Cancel the delay start.
The door is not fully closed.	Close the door firmly.

Why is there no noise when the oven door is opened during operation?

This is normal. If the door is opened during operation, a safety contact switch causes the heating elements and the fan to shut off.

Why is a noise heard after turning the oven off?

This is normal. The fan will continue to run for a short time to cool the oven. When the oven has cooled sufficiently, the fan will turn off automatically.

Why is the display dark when the oven is first turned on?

Possible fault	Solution
The clock display has been turned off.	Turn the display on: Turn the oven on. Select "Settings" - "Clock" - "Display on".

What if the time of day cannot be entered after a power failure?

Possible fault	Solution
The system lock is activated.	Deactivate the system lock.

Why is there uneven browning?

Possible fault	Solution
Oven not preheated.	Allow the oven to preheat.
Oven temperature too high.	Lower the oven temperature.
Shiny or thin pans were used.	Use dark, matte finish pans.

What if "Fault" followed by two numbers appears in the display?

Possible fault	Solution
An electronic fault has occurred.	Call Technical Service for assistance.
"Fault 55" the oven has shut down or the Sabbath function has finished.	Turn off the oven to reset it to normal operation.

In the event of a fault which you cannot easily fix yourself, please contact the Miele Technical Service Department:

USA 1-800-999-1360
techserv@mieleusa.com

CDN 1-800-565-6435
service@miele.ca

When contacting Technical Service please quote the serial number and model of your oven. This information is visible on the silver data plate.

MieleCare

(USA only)

MieleCare, our Extended Service Contract program, gives you the assurance of knowing that your appliance investment is covered by 5 years of worry free ownership. *MieleCare* is the only Extended Service Contract in the industry that guarantees repairs by a Miele Authorized Service Provider using genuine Miele parts. Only genuine Miele parts installed by factory trained professionals can guarantee the safety, reliability, and longevity of your Miele appliance.

Please note that unless expressly approved in writing by Miele's Service department, Extended Service Contracts offered by other providers for Miele products will not be recognized by Miele. Our goal here is to prevent unauthorized (and untrained) service personnel from working on your Miele products, possibly doing further damage to them, you and/or your home.

To learn more about *MieleCare* Extended Service Contracts, please contact your appliance dealer or visit us online at:

<http://mieleusa.com/mielecare>

Optional accessories

The following accessories are available for purchase from your Local Miele Dealer or from Miele.

Gourmet Pizza form

This circular form is suitable for cooking fresh or frozen pizzas, flat cakes, tarts, and baked desserts.

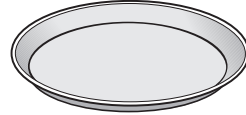

Gourmet Baking stone

The Baking stone is ideal for baking dishes with a crisp bottom like pizza and bread.

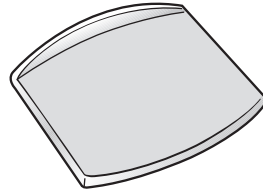

Gourmet Casserole Dish

The Gourmet Casserole can be set on the wire rack.

The casserole has a special non-stick coating and is available in two sizes (large: HUB 61-35, small HUB 61-22).

A lid is also available separately.

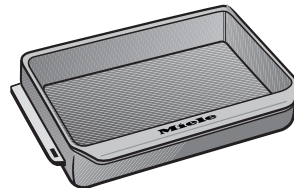
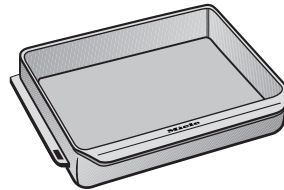

Gourmet Casserole Dish Lid

The lid is available in two sizes
(large: HBD 60-35, small HBD 60-22).

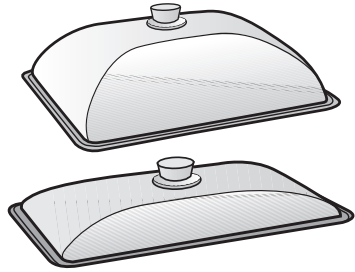

Anti-splash insert

The anti-splash insert may be placed in
the roasting pan to reduce splattering
of drippings from meat or poultry.

The anti-splash insert is coated with
PerfectClean enamel and can be easily
cleaned with a sponge and dish soap.

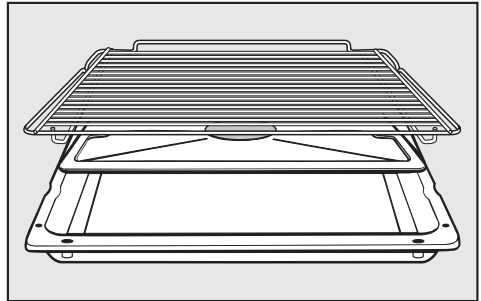



Installation Instructions

Information is subject to change. Please refer to our website to obtain the most current product specification, technical & warranty information.

Caring for the environment

Disposal of the packing materials

The cardboard box and packing materials protect the appliance during shipping. They have been designed to be biodegradable and recyclable.

Ensure that any plastic wrappings, bags, etc. are disposed of safely and kept out of the reach of children.
Danger of suffocation!

Disposal of an old appliance

Old appliances may contain materials that can be recycled. Please contact your local recycling authority about the possibility of recycling these materials.

Ensure the appliance presents no danger to children while being stored for disposal. Before discarding an old appliance, unplug it from the outlet and cut off its power cord. Remove any doors to prevent trapping hazards.

⚠ CAUTION: Before servicing, disconnect the power supply by either removing the fuse, shutting off the power main or manually "tripping" the circuit breaker.

Installation work and repairs should only be performed by a qualified technician in accordance with all applicable codes and standards. Repairs and service by unqualified persons could be dangerous and the manufacturer will not be held responsible.

Before connecting the appliance to the power supply, make sure that the voltage and frequency listed on the data plate correspond with the household electrical supply. This data must correspond to prevent machine damage. Consult an electrician if in doubt.

Only operate the appliance after it has been installed into cabinetry.

Installer:
Please leave these instructions with the consumer.

Power supply

The oven is equipped with a 6 ft. (1.8 m) flexible power cord consisting of 4 wires ready for connection to a dedicated 3 pole, 4 wire grounded power supply:

– 120/240 V, 60 Hz, 40 A fuse rating
or

– 120/208 V, 60 Hz, 40 A fuse rating

Black wire: connect to L1 (hot)

Red wire: connect to L2 (hot)

White wire: connect to N (neutral)

Green wire: connect to GND (ground)

A dedicated line and junction box should be used to connect the oven to a 40 A circuit.

Connection details are also given on the diagram located on the top of the oven.

Data plate

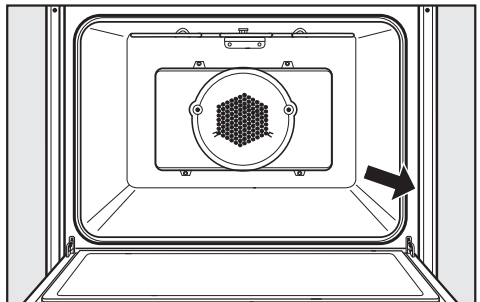

The silver data plate is located along the front side of the lower oven with the door open.

Appliance and Cut-out Dimensions

Miele appliances can be installed flush or proud. Discuss your installation requirements with your architect, designer and installer.

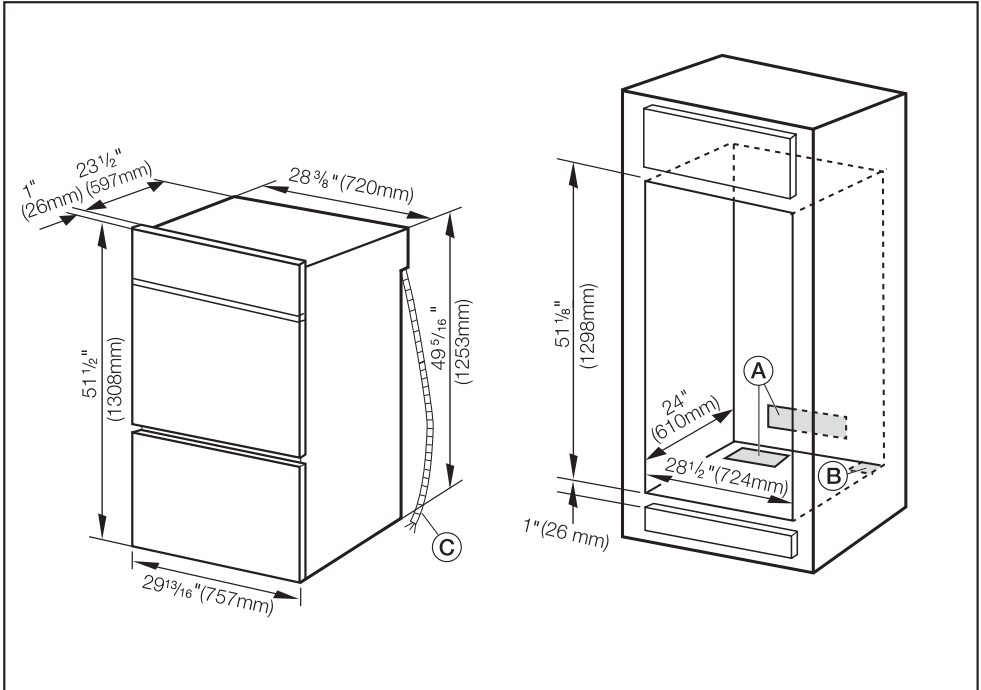

- Ⓐ Vent (min. 24" ² / 150 cm²) cut-out possible at rear **or** platform of cabinet
- Ⓑ Cut-out for power cord (min. 1" ² / 3 cm²)
- Ⓒ Power cord

For the most current specifications see the Miele web site.

The oven must be installed into cabinetry and be supported from underneath.

IMPORTANT INFORMATION

Certain cabinet materials and finishes are very sensitive to high temperatures. To eliminate the risk of damage to surrounding cabinets, a 24 square inch (2"x12") [150 cm²] minimum opening must exist in the cabinet to allow air to flow into and around the appliance.

In addition, the oven vent at the bottom of the door (bottom of the lower door in a double oven) must not be obstructed.

- Adhere the skid plates to the cabinet floor.

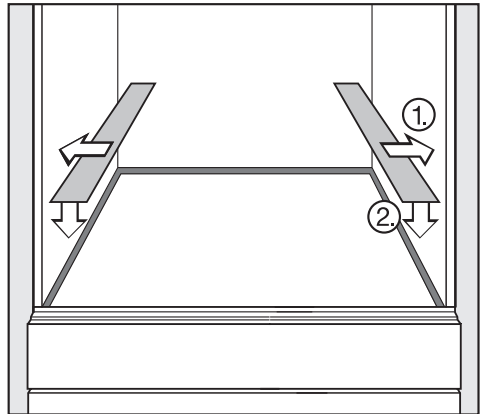

- Prepare the door for removal. Flip up the locking clamps on each door hinge.



Installing the oven

- Slowly shut the door until the protruding clamps stop the movement. Pull the door upward.

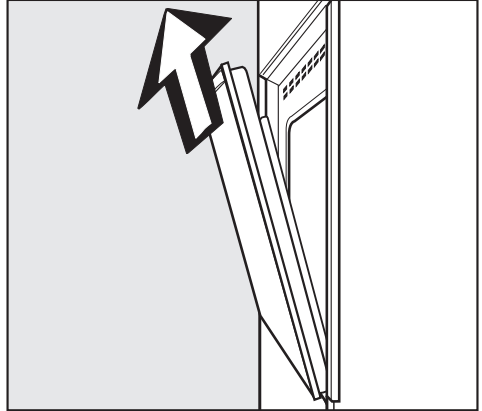

- Connect the oven to the electrical supply.
- Slide the oven into the cabinet and align.
- Reinstall the door.

- Open the oven door and locate the four mounting screw holes in the oven frame. Mark and drill 6 mm pilot holes. Secure the oven to the cabinetry by inserting screws through the frame and into the cabinetry.

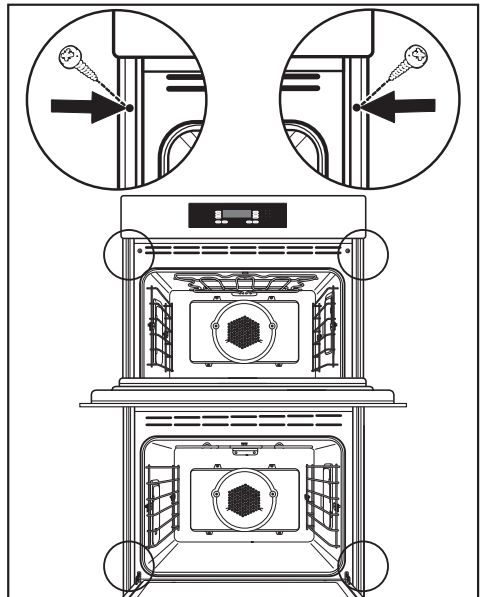

Set the time

"Enter Time: hh:mm" will appear in the display once the oven is connected to electricity.

- Set the current time using the keypad.
- Save the time by touching the "OK" control.

Please have the model and serial number of your appliance available before contacting Technical Service.



U.S.A. Miele, Inc.

National Headquarters

9 Independence Way
Princeton, NJ 08540
Phone: 800-843-7231
609-419-9898
Fax: 609-419-4298
www.mieleusa.com

Technical Service & Support Nationwide

Phone: 800-999-1360
Fax: 888-586-8056

TechnicalService@mieleusa.com

Canada Miele Limited

Headquarters and Showroom

161 Four Valley Drive
Vaughan, ON L4K 4V8
Phone: 800-643-5381
905-660-9936
Fax: 905-532-2290
www.miele.ca
professional@miele.ca
(commercial enquiries)

MieleCare National Service

Phone: 800-565-6435
905-532-2272
Fax: 905-532-2292
customercare@miele.ca
(general and technical enquiries)

Germany

Miele & Cie. KG
Carl-Miele-Straße 29
33332 Gütersloh

Alteration rights reserved / 2311
(H 4894 BP2)

M.-Nr. 07 964 290 / 00

INFORMATION IS SUBJECT TO CHANGE. PLEASE REFER TO OUR WEBSITE TO OBTAIN THE MOST CURRENT PRODUCT SPECIFICATIONS, TECHNICAL & WARRANTY INFORMATION.

Download from Www.Somanuals.com. All Manuals Search And Download.

Free Manuals Download Website

<http://myh66.com>

<http://usermanuals.us>

<http://www.somanuals.com>

<http://www.4manuals.cc>

<http://www.manual-lib.com>

<http://www.404manual.com>

<http://www.luxmanual.com>

<http://aubethermostatmanual.com>

Golf course search by state

<http://golfingnear.com>

Email search by domain

<http://emailbydomain.com>

Auto manuals search

<http://auto.somanuals.com>

TV manuals search

<http://tv.somanuals.com>