

Miele

Operating instructions

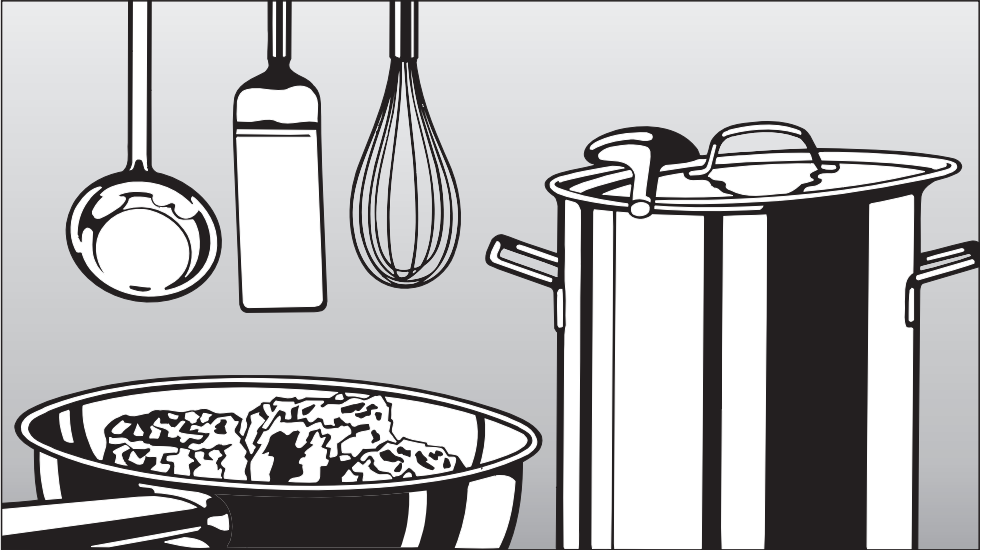

Gas hob KM 417

To avoid the risk of accidents or damage to the appliance it is **essential** to read these instructions before it is installed or used for the first time.



M.-Nr. 05 721 920

Contents

| | |
|--|----|
| Description of the appliance | 3 |
| Warning and Safety instructions | 4 |
| Caring for the environment | 10 |
| Before using for the first time | 11 |
| General notes | 11 |
| Cleaning and heating up for the first time | 11 |
| Using the gas hob | 12 |
| Switching on, Switching off, Controls. | 12 |
| Pans | 13 |
| Safety cut-out. | 14 |
| Use during a power cut. | 14 |
| Cleaning and care | 15 |
| General notes | 15 |
| E-Cloth | 15 |
| Pan supports, controls. | 16 |
| Ceramic surface | 16 |
| Burners | 17 |
| Problem solving guide | 19 |
| Connection to services | 20 |
| Gas connection | 20 |
| Electrical connection | 21 |
| After sales service | 23 |
| Data plate | 23 |

Description of the appliance

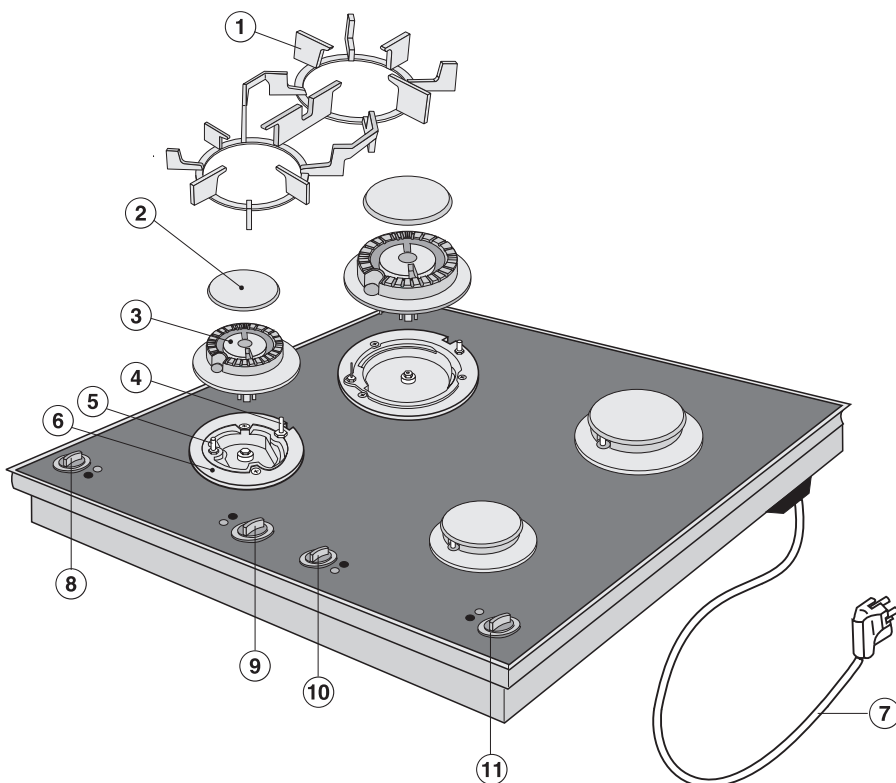

- ① Pan support
- ② Burner cap
- ③ Burner head
- ④ Ignition safety device
- ⑤ Ignitor
- ⑥ Burner base
- ⑦ Mains connection cable *

Control knobs:

- ⑧ Front left
- ⑨ Back left
- ⑩ Back right
- ⑪ Front right

* Depending on country of destination, the appliance may be supplied with or without a plug. The plug shown is for illustration only.

Warning and Safety instructions

This appliance complies with all relevant legal safety requirements. Incorrect use can, however, lead to personal injury and damage to the appliance.

To avoid the risk of accidents and damage to the appliance, read these instructions carefully before using it for the first time. They contain important notes on the installation, safety, operation and care of the appliance.

Keep these instructions in a safe place for reference and pass them on to any future user.

Building in and connection

The connection to the gas supply must be carried out by a suitably qualified and competent person in accordance with local and national safety regulations, e.g. a Corgi registered service technician in the U.K. If the appliance is supplied without a plug, or if the plug is removed, it must be connected to the mains electricity supply by a suitably qualified and competent electrician in strict accordance with local and national safety regulations. The manufacturer cannot be held liable for damage caused by incorrect installation or connection.

The electrical safety of this appliance can only be guaranteed when continuity is complete between it and an effective earthing system which complies with local and national safety regulations. It is most important that this basic safety requirement is present and tested regularly, and where there is any doubt, the household wiring system should be inspected by a qualified electrician. The manufacturer cannot be held liable for the consequences of an inadequate earthing system (e.g. electric shock).

Ensure that the gas pipe and electrical cable are installed in such a way that they do not touch any parts of the appliance which become hot. This could cause damage.

Do not connect the appliance to the mains electricity supply by an extension lead. Extension leads do not guarantee the required safety of the appliance (e.g. danger of overheating).

This equipment may only be used in mobile installations such as ships, caravans, aircraft etc. if a risk assessment of the installation has been carried out by a suitably qualified engineer.

Warning and Safety instructions

Correct usage

■ For safety reasons the appliance must only be used after it has been built in. This is necessary to ensure that all electrical components are shielded.

■ This appliance is intended for domestic use only and is not to be used for commercial purposes.

■ Use this appliance for the preparation of meals only. Any other usage is at the owner's risk and could be dangerous. The manufacturer cannot be held liable for damage caused by incorrect or improper use of the appliance.

■ Do not use the appliance to heat up the room. Due to the high temperatures radiated, objects near the appliance could catch fire. The life of the appliance could also be reduced.

■ Using the gas hob will cause a build-up of heat and moisture in the room in which it is installed. Ensure that the room has sufficient natural or mechanical means of ventilation, e.g. an extractor.

■ If the hob is used for very long periods of time, additional ventilation of the room may be necessary, e.g. by opening windows or doors, or running the extractor on the highest setting.

■ This appliance must not be set up or operated in the open air.

■ Make sure all the components of the gas burner have been correctly assembled before switching on.

■ When using a cooker hood over the gas hob, ensure that any burners in use are always covered with a pan. Otherwise flames could be drawn up by the suction of the cooker hood, parts of which could then be damaged or even set on fire.

■ Pans must be the correct size for the burner they are used on (see "Pans"). A pan which is too small will be unstable on the pan support. If the pan diameter is too large, flames can spread out to the sides and damage or burn the worktop, wall claddings or surrounding units and also parts of the hob. The manufacturer cannot be held liable for this type of damage.

■ Do not store any inflammable objects near the gas hob.

Warning and Safety instructions

Safety with children

■ The appliance is only intended for use by adults who have read these operating instructions.

■ This appliance is not a toy! To avoid the risk of injury keep children well away and do not let them play with it or use the controls. They will not understand the potential dangers posed by it. They should be supervised whenever you are working in the kitchen.

■ Older children may use the appliance only when its operation has been clearly explained to them, and they are able to use it safely, recognising the dangers of misuse. Supervise its use by the elderly or infirm.

■ The appliance gets hot when in use and remains hot for quite a while after being switched off. To safeguard against burning, keep children well away from the appliance at all times.

■ Do not store anything which might arouse a child's interest in storage areas above or next to the appliance. Otherwise they could be tempted into climbing onto the appliance with the risk of burning themselves.

■ Keep all pans out of reach of children. Turn pan handles inwards away from the edge of the hob. Danger of burning or scalding. Special hob guards are available from good retail outlets.

■ Packaging (e.g. cling film, polystyrene) and plastic wrappings must be kept out of the reach of babies and young children. Danger of suffocation. Dispose of or recycle all packaging safely as soon as possible.

■ Before disposing of an old appliance, disconnect it from the gas and electricity supplies. Cut off and render any plug useless. Cut off the cable directly behind the appliance to prevent misuse. This should be done by a competent person.

Protecting the appliance from damage

Do not drop anything on the ceramic surface. Even a light object could cause damage in certain circumstances.

Unless the pan manufacturer states that you can do so, do not use pans with very thin bases on this hob, and never heat up empty pans as they could get damaged. This could also damage the appliance.

Do not use a steam cleaner to clean this appliance. The steam could reach electrical components and cause a short circuit. Pressurised steam could also cause permanent damage to the surface and to other components, for which the manufacturer cannot accept liability.

In countries where there are areas which may be subject to infestation by cockroaches or other vermin, pay particular attention to keeping the appliance and its surroundings in a clean condition at all times. Any damage which may be caused by cockroaches and other vermin will not be covered by the appliance guarantee.

Protection from burning

The appliance gets hot when in use, and remains hot for quite a while after being switched off. Do not touch it whilst it is still hot.

To avoid burning yourself, use oven gloves. Ensure that these do not come into contact with the flames. Do not use large cloths, tea towels or similar as the ends could touch the flames and catch fire. Take care not to let the gloves get damp or wet, as this causes heat to transfer through the material more quickly with the risk of scalding or burning yourself.

Do not heat up unopened tins of food on the hob as pressure will build up in the tin and it can explode. This could result in injury and scalding or damage.

Do not use the hob as a resting place for anything else. The article could melt or catch fire if residual heat is still present or if the appliance is switched on by mistake.

Do not cover the appliance, e.g. with a cloth, kitchen foil, etc. This could be a fire hazard if the appliance is switched on by mistake.

Warning and Safety instructions

■ Remove splashes of fat and other food debris from the surface as soon as possible. These are a fire hazard.

■ Never leave the appliance unattended when cooking with oil or fat as these are fire hazards if overheated. Very hot oil can catch fire and could even set a cooker hood above on fire. Always heat fat slowly, watching as it heats.

■ If, despite this, oil or fat does catch fire, do not attempt to put out the flames with water. Use a suitable fire extinguisher or fire blanket, saucepan lid, damp towel or similar to smother the flames.

■ Do not flambé under a cooker hood. The flames could set the cooker hood on fire.

■ Ensure that the flames from the burner do not spread out beyond the base and up the sides of the pan.

Warning and Safety instructions

Appliance faults

■ In the event of damage or a defect, switch off the appliance immediately. Turn off the gas supply tap, and disconnect completely from the electricity supply. If the appliance has not yet been fully installed, the electricity cable must be disconnected from the supply point. If connected via a plug and socket, switch off at the socket and withdraw the plug. Contact the Service Department. Do not reconnect the appliance to the mains electricity supply until after it has been repaired.

■ If there is any damage to the ceramic surface the appliance must be disconnected from the mains electricity and gas supplies immediately and not used until it has been repaired. Danger of electric shock.

■ Repairs to the gas and electrical components of this appliance must only be carried out by a suitably qualified person. Repairs and other work by unqualified persons could be very dangerous and could damage the appliance. The manufacturer cannot be held liable for unauthorised work. Never open the housing of the appliance.

■ While the appliance is under guarantee, repairs should only be undertaken by a service technician authorised by the manufacturer. Otherwise the guarantee is invalidated.

Further safety notes

■ When using an electric socket near the appliance, care should be taken that the cable of the electrical appliance does not come into contact with the hot appliance. The insulation on the cable could become damaged, giving rise to an electric shock hazard.

■ Always ensure that food is sufficiently cooked or reheated. Many factors will affect the overall cooking time, including the size and amount of food and its temperature. Some foods, e.g. poultry, may contain micro-organisms which are only destroyed by thorough cooking at a sufficiently high temperature for long enough. If in doubt, select a longer cooking or reheating time.

■ Do not use plastic or aluminium foil containers. These melt at high temperatures and could catch fire.

■ Spray canisters, aerosols and other inflammable substances must not be stored in a drawer under the hob. Cutlery inserts must be heat-resistant.

■ If the appliance has not been used for a longer period of time it should be thoroughly cleaned before it is used again. It is also advisable to have the appliance tested for safety. This should be done at regular intervals.

The manufacturer cannot be held liable for damage caused by non-compliance with these Warning and Safety instructions.

Caring for the environment

Disposal of the packing material

has been selected from materials which are environmentally friendly for disposal and can normally be recycled.

Packaging (e.g. cling film, polystyrene) and plastic wrappings must be kept out of the reach of babies and young children. Danger of suffocation. Dispose of or recycle all packaging materials safely as soon as possible.

Disposal of your old appliance

Electrical and electronic appliances often contain materials which, if handled or disposed of incorrectly, could be potentially hazardous to human health and to the environment. They are, however, essential for the correct functioning of your appliance. Please do not therefore dispose of your old appliance with your household waste.

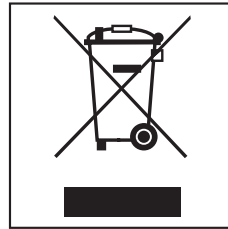

Please dispose of it at your local community waste collection / recycling centre and ensure that it presents no danger to children while being stored for disposal.

It should be unplugged or disconnected from the mains electricity supply by a competent person. If connected by a plug, the plug must be rendered useless and the cable cut off directly behind the appliance to prevent misuse.

Before using for the first time

General notes

Please stick the extra data plate for the appliance supplied with this documentation in the space provided in the "After sales service" section of this booklet.

Cleaning and heating up for the first time

Before using for the first time clean the hob and all removable parts as follows:

- The removable parts of the gas burner assembly can be washed in a mild solution of hot water and washing up liquid. Wipe dry and reassemble in the correct order (see "Cleaning and care").
- Clean the ceramic surface with a damp cloth only, and then wipe dry.

Do not use washing up liquid to clean the ceramic surface as it can leave a blue sheen which may be difficult to remove.

Metal components have a protective coating which may give off a slight smell when heated up for the first time. The smell and any vapours will dissipate after a short time and do not indicate a faulty connection or appliance defect.

Using the gas hob

Switching on, Switching off, Controls

The controls are used to switch on the burners and regulate the strength of the flame.

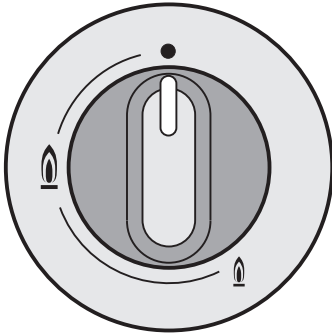

- the gas supply is turned off

🔥 strong flame

🔥 weak flame

Switching on:

- The control for the burner required must be pressed in and turned anti-clockwise to the large flame symbol to switch on.
- When the flame ignites, keep the control pressed in for 8-10 seconds, and then let it go.

If the flame goes out, repeat the procedure, keeping the control pressed in for a few extra seconds.

- With the control no longer pressed in you can continue turning it towards the small flame symbol.

Control the flame so that it does not spread out beyond the sides of the pan. As the outer part of the flame is much hotter than the centre, the tips of the flames should stay beneath the pan base. Flame tips which extend beyond the sides of the pan merely warm up the air in the room and can also damage pan handles and increase the danger of burning.

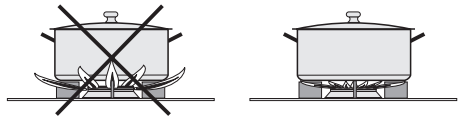

Switching off:

- Turn the control clockwise until the ● position is reached.

This stops the flow of gas and the flame goes out.

Remember: Turn anti-clockwise to switch on, turn clockwise to switch off. The controls cannot be turned anti-clockwise from the small flame symbol to the "●" position.

Pans

| Burners | Min. pan base diameter in cm |
|---------|-----------------------------------|
| small | 12 |
| large | 14 |
| | Max. diameter at top of pan in cm |
| small | 22 |
| large | 24 |

- Select pans which are suitable for the burner they are to be used on. In general: use larger diameter pans on the large burner and smaller diameter pans on the small burner.
- Wide, shallow pans are preferable to tall, narrow ones. They will heat up faster.



- Pans with thick bases are preferable as these distribute heat more evenly. With thin bases, there is a danger of food overheating in places. Stir the food frequently.

- Any heat-resistant pans can be used on a gas burner.
- Remember when purchasing new pans that manufacturers usually refer to the diameter at the top of the pan in their documentation.
- Refer to the chart above and ensure that the pan diameter falls within the minimum and maximum diameters given for the burner you are using. A pan which is too small will be unstable on the pan support. If the pan diameter is too large, flames can spread out to the sides and damage or burn the worktop, wall claddings or surrounding units and also parts of the hob. The manufacturer cannot be held liable for this type of damage.
- Use a pan lid whenever possible to minimise heat loss.

Using the gas hob

Safety cut-out

This appliance is fitted with an electric ignition safety device which cuts off the supply of gas to a burner if the flame goes out, for example if food has boiled over, or if there was a sudden draught.

- To use the hob again, turn the control clockwise until the ● position is reached and switch on as normal.

The safety cut-out operates independently from the electricity supply. This means that it is still active when the hob is used during a power cut (see "Use during a power cut").

Use during a power cut

If there is an interruption to the electricity supply the gas can be ignited with a match:

- Press in the relevant control and turn it anti-clockwise to the large gas symbol.
- Hold the control pressed in and light the gas at the burner with a match.
- Keep the control pressed in for a further 8-10 seconds and then release it.

General notes

Clean the appliance regularly, preferably after each use. Allow the appliance to cool down to a safe temperature before cleaning.

Do not use a steam cleaner to clean this appliance. The steam could reach electrical components and cause a short circuit. Pressurised steam could also cause permanent damage to the surface and to other components for which the manufacturer cannot accept liability.

Do not use any sharp objects which could damage the seal between the ceramic surface and the surrounding frame and between the frame and the worktop.

Do not use any of the following on your hob as they can damage the surface:
cleaning agents containing sand, soda, alkalines, acids or chlorides, grill and ovensprays, dishwasher detergent, stain or rust removers, scouring agents or cream cleaners, abrasive sponges and brushes.

Do not use washing up liquid to clean the ceramic surface as it can leave a blue sheen which may be difficult to remove.

The ceramic surface can be cleaned using a proprietary cleaning agent for ceramic surfaces. Follow the manufacturer's instructions on the packaging.

Do not let the ignitor in the burner get wet. If it gets wet it will not spark.

After cleaning, dry thoroughly with a soft cloth to prevent a build up of limescale deposits.

E-Cloth

A microfibre "E-Cloth" is available from the Miele UK Spare Parts Department, which is suitable for cleaning surfaces such as stainless steel, glass, plastic and chrome without the use of chemicals.

Cleaning and care

Pan supports, controls

Remove the pan supports.

Clean the pan supports and the controls with a solution of hot water and a little washing up liquid applied with a soft sponge. Soak stubborn soiling first to loosen it.

Finally, wipe dry using a soft cloth.

Ceramic surface

Wipe all coarse soiling off using a damp cloth. Stubborn soiling may need to be removed with a shielded scraper blade.

Then apply a few drops of a proprietary cleaning agent for ceramic surfaces using a soft cloth or kitchen paper towel. This way any limescale deposits, caused for example by water boiling over, are removed.

Finally wipe the hob surface with a damp cloth and then dry it with a clean soft cloth.

Note that some cleaning agents contain a protective additive designed to prevent water marks and smears adhering to the surface.

Burners

The burners can be dismantled for cleaning once they have cooled down.

Dismantle the burner as follows:

- Take off all the removable parts of the burner and wash in a solution of hot water and washing up liquid. Then dry them all thoroughly. Make sure that the flame holes are clean and completely dry.

The surface of the burner cap will gradually become more matt with time. This is quite normal and will not affect the operation of the hob.

- Wipe the fixed parts of the burner base with a damp cloth and dry afterwards.
- Gently wipe the ignitor and the ignition safety device with a well wrung-out cloth and wipe dry with a clean cloth.

Cleaning and care

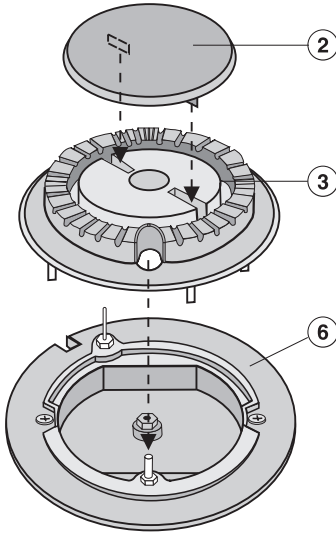

Re-assemble the burner as follows (see illustration):

- Make sure that all the locating tabs and notches line up exactly. Place the burner head ③ on to the burner base ⑥ so that the ignitor and the ignition safety device extend through their respective holes in the burner head. The burner head must click into place correctly.
- Replace the burner cap ② ensuring that the locating tabs fit into the notches in the burner head.

Important: replace parts in the correct order after cleaning.

1. Do not replace the parts upside down.
2. The locating tabs must fit exactly into the notches.

Repairs to the gas and electrical components of this appliance must only be carried out by a suitably qualified and competent person to ensure safety. Unauthorised repairs could be dangerous.

However, some minor problems can be resolved as follows:

What to do if ...

... the burner does not ignite after several attempts

Check whether

- The burner is correctly assembled.
- The gas supply tap is turned on.
- The burner is dry and clean.
- The flame slits are clean and unblocked.
- The mains fuse has blown. If this is the case, call an electrician or the Service Department. (The gas can be lit with a match). See "Use during a power cut".

... the gas flame goes out after being lit

Check whether the burner cover is correctly assembled.

... the ignitor on the burner does not spark

Check whether food deposits have lodged themselves between the ignitor and the burner cover.

Carefully remove any soiling. Do not let the ignitor get wet.

... the flame suddenly looks different

Check whether the burner is correctly assembled.

Connection to services

Important

This appliance should be installed with plenty of space on either side. See Installation Instruction Booklet before making the gas and electrical connection.

Gas connection

Connection to the appropriate gas supply, or conversion from one type of gas to another should be carried out in strict accordance with local and national safety regulations by an approved and registered gas installer (e.g. Corgi registered in the U.K.) who is responsible for the correct functioning of the appliance when installed.

Check with your local gas supplier about the type of gas and its calorific value and compare this information with the type of gas quoted on the hob data plate.

The gas installation must be made in such a way that the isolating valve is visible and easily accessible after the appliance has been built in.

Corgi regulations state that a pressure test nipple must be installed near a gas hob to allow an engineer to test the pressure following servicing.

This gas hob is normally suitable for connection to either natural or liquid gas. Check suitability in your country with your dealer or agent.

Category EN 30:

United Kingdom:

GB II 2 H 3 + 20 mbar, 28-30/37 mbar.

Ireland:

IE II 2 H 3 + 20 mbar, 28-30/37 mbar.

Depending on country, a set of jets for conversion to liquid gas is included with the hob.

Conversion to another type of gas is described in the separate Installation Instructions supplied with this hob.

Electrical connection

All electrical work should be carried out by a suitably qualified and competent person in strict accordance with national and local safety regulations.

Installation, repairs and other work by unqualified persons could be dangerous. The manufacturer cannot be held liable for unauthorised work.

Ensure power is not supplied to the appliance until after installation or repair work has been carried out.

The appliance must only be operated when built-in. This is to ensure that all electrical parts are shielded. Live parts must not be exposed.

Do not connect the appliance to the mains electricity supply by an extension lead. These do not guarantee the required safety of the appliance.

The **voltage and connected load** are given on the **data plate**. Ensure that these match the household mains supply.

Connection should be made via a suitable isolator or a double pole fused spur connection unit which complies with national and local safety regulations and the on/off switch should be easily accessible after the appliance has been built in.

If the switch is not accessible after installation (depending on country) an additional means of disconnection must be provided for all poles.

For extra safety it is advisable to install a residual current device (RCD) with a trip current of 30 mA.

When switched off there must be an all-pole contact gap of 3 mm in the isolator switch (including switch, fuses and relays).

Important U.K.

This appliance is supplied for connection to a single phase 230-240 V 50 Hz supply with a 3-core cable.

The wires in the mains lead are coloured in accordance with the following code:

Green/yellow = earth

Blue = neutral

Brown = live

WARNING
THIS APPLIANCE MUST BE
EARTHED

Connection to services

Important

The electrical safety of this appliance can only be guaranteed when continuity is complete between the appliance and an effective earthing system, which complies with local and national regulations. It is most important that this basic safety requirement is tested regularly and if there is any doubt the electrical wiring in the home should be tested by a qualified electrician. The manufacturer cannot be held liable for the consequences of an inadequate earthing system such as an electric shock.

The manufacturer cannot be held liable for damage which is the direct or indirect result of incorrect installation or connection.

In the event of any faults which you cannot remedy yourself, please contact

– Your Miele Dealer

or

– The Miele Service Department (see address on back cover).

When contacting the Service Department, please quote the model and serial number of your appliance. These are given on the data plate.

Please note that telephone calls may be monitored and recorded to improve our service.

Data plate

Space in which to stick the extra data plate supplied with the appliance. Ensure that the model number is the same as the one on the front of these operating instructions.

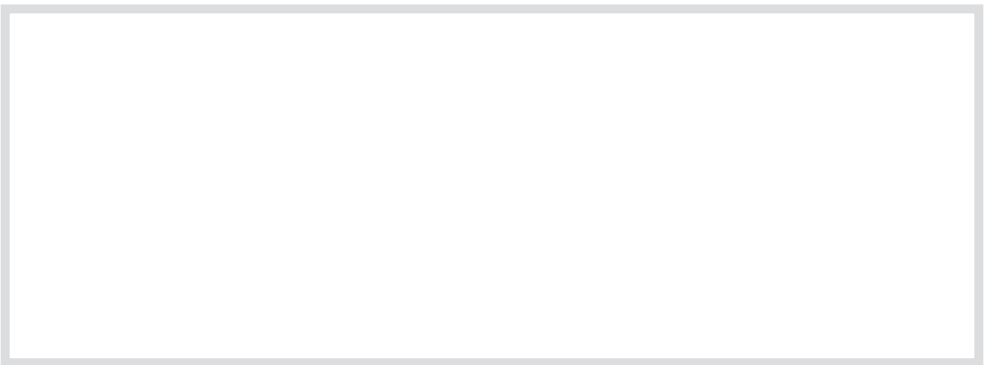

United Kingdom:

Miele Co. Ltd.
Fairacres, Marcham Road
Abingdon, Oxon, OX14 1TW
tel. Abingdon (01235) 554455
Service Office: (01235) 554466
fax (01235) 554477
Internet: www.miele.co.uk

Ireland:

Miele Ireland Ltd.
Broomhill Road, Tallaght, Dublin 24
Tel: (01) 46 10 710, Fax: (01) 46 10 797
Email: info@miele.ie
Internet: <http://www.miele.ie>

Australia:

Miele Australia Pty. Ltd.
A.C.N. 005635398
1 Gilbert Park Drive
Knoxfield, VIC 3180
Telephone: (03) 9764 7100
Fax: (03) 9764 7129
Internet: www.miele.com.au

Distributor New Zealand:

Steelfort Engineering Company. Ltd.
500 Rangitikei Street
Palmerston North, Priv. Bag 11045, NZ
Telephone: (06) 350 1350
Fax: (06) 356 1507

South Africa:

Miele (Pty) Ltd
63 Peter Place
Bryanston 2194
P.O. Box 69434
Bryanston 2021
Tel.: (011) 548 1900
Telefax (011) 548 1935
Internet: www.miele.co.za
E-mail: info@miele.co.za

Singapore:

Miele Southeast Asia
Miele Pte. Ltd.
163 Penang Road
04 - 02/03 Winsland House II
Singapore 238463
Tel : +65-67351191
Fax: +65-67351161
Email: infosea@miele.com.sg

Hong Kong:

Miele (Hong Kong) Limited
AIA Plaza, 24th Floor
18 Hysan Avenue
Causeway Bay
Hong Kong
Tel.: (852) 2610 1331
Fax: (852) 2610 1013
E-mail: mielehk@miele.com.hk

Free Manuals Download Website

<http://myh66.com>

<http://usermanuals.us>

<http://www.somanuals.com>

<http://www.4manuals.cc>

<http://www.manual-lib.com>

<http://www.404manual.com>

<http://www.luxmanual.com>

<http://aubethermostatmanual.com>

Golf course search by state

<http://golfingnear.com>

Email search by domain

<http://emailbydomain.com>

Auto manuals search

<http://auto.somanuals.com>

TV manuals search

<http://tv.somanuals.com>