

# Miele

## Operating Instructions

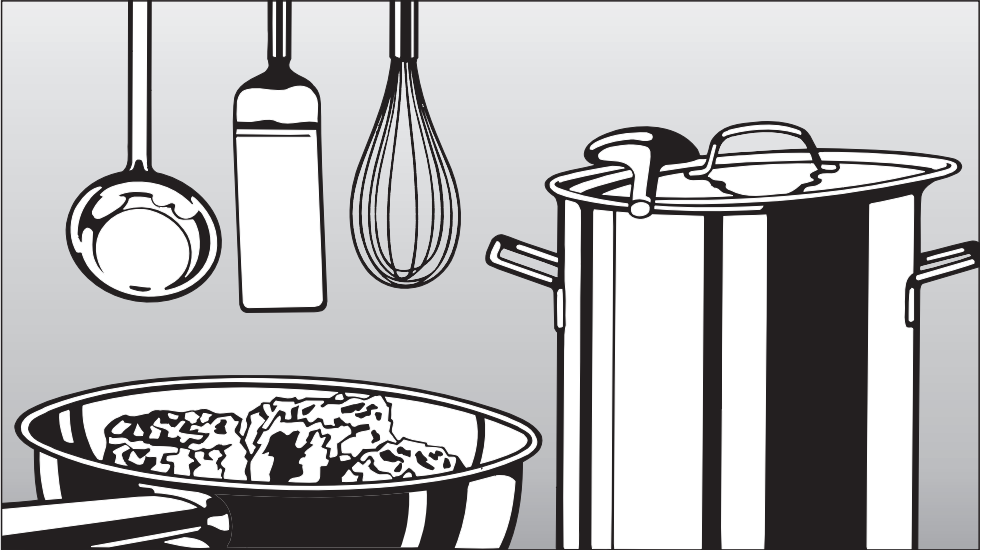

## Ceramic Cooktop KM 451

To prevent accidents and machine damage, read these instructions **before** installation or use.



M.-Nr. 05 361 900

# Contents

---

<b>IMPORTANT SAFETY INSTRUCTIONS</b> . . . . .	3
<b>Help protect our environment</b> . . . . .	9
Disposal of packing materials . . . . .	9
Disposal of an old appliance . . . . .	9
<b>Guide to the cooktop</b> . . . . .	10
Cooking zone controls and displays . . . . .	12
Cooking zones . . . . .	13
<b>Before using for the first time</b> . . . . .	14
Clean the cooktop . . . . .	14
Heat the cooktop . . . . .	14
Touch controls . . . . .	14
<b>Using the cooktop</b> . . . . .	15
Turning on the cooktop . . . . .	15
Turning on a burner . . . . .	15
Cooking without auto heat . . . . .	16
Cooktop settings . . . . .	17
Auto heat . . . . .	18
Turning on an extended cooking zone . . . . .	19
Turning off a cooking zone . . . . .	19
To turn off the cooktop . . . . .	20
Residual heat indicator . . . . .	20
<b>Safety locks</b> . . . . .	21
Child safety lock . . . . .	21
Safety cut-out feature . . . . .	22
Overheating protection . . . . .	24
<b>Selecting cookware</b> . . . . .	25
The cooking surface . . . . .	25
<b>Timer</b> . . . . .	27
To set the timer . . . . .	27
Automatically turning off a cooking zone . . . . .	28
<b>Cooktop care</b> . . . . .	29
<b>Frequently asked questions</b> . . . . .	30
<b>Technical Service</b> . . . . .	32

# IMPORTANT SAFETY INSTRUCTIONS

---

## READ THE OPERATING INSTRUCTIONS CAREFULLY BEFORE USING THE COOKTOP

### WARNING -

**This appliance is only intended for residential cooking. The manufacturer can not be held responsible for damage or injury caused by improper use or for uses other than those for which this appliance is intended.**

When using your appliance, follow basic safety precautions including the following:

### Installation

■ Be certain your appliance is properly installed and grounded by a qualified technician in accordance with national and local safety regulations. The manufacturer cannot be held responsible for damage caused by an incorrect installation or connection.

■ To guarantee the electrical safety of this appliance, continuity must exist between the appliance and an effective grounding system. It is imperative that this basic safety requirement is met. If there is any doubt, have the electrical system of the house checked by a qualified electrician. The manufacturer cannot be held responsible for damages caused by the lack, or inadequacy of, an effective grounding system.

■ Do not connect the appliance to the main electrical supply using an extension cord. Extension cords do not meet the safety requirements of this appliance.

■ Before servicing, disconnect the power supply by either shutting off the power main or manually "tripping" the circuit breaker.

# IMPORTANT SAFETY INSTRUCTIONS

---

■ Do not install the cooktop directly above a dishwasher, refrigerator or freezer. Heat radiated by the cooktop may damage them.

■ If the cooktop is installed above an oven, keep the cooktop's power cord from contacting the oven.

■ Because of the heat radiated it is not recommended to install the cooktop above a drawer. It should only be installed above a cabinet base unit with a dummy drawer front and an additional protective base between the appliance and the cabinet.

■ This equipment has not been designed for maritime use or for use in mobile installations such as aircraft or recreational vehicles. However, under certain circumstances it may be possible for an installation in these applications. Please contact the nearest Miele Dealer or the Miele Technical Service Department with specific requirements.

## Use

■ Do not use the appliance until it is properly installed in the countertop.

■ This appliance is equipped with an overheating protection feature. See, "Overheating protection" for information.

■ Never use the appliance to warm or heat the room. Due to the high temperatures radiated objects left near the appliance could catch fire.

# IMPORTANT SAFETY INSTRUCTIONS

---

## Protection from damage

Do not drop anything on the ceramic surface of the cooktop. Although the ceramic glass is shock and scratch resistant, it is not shock or scratch proof.

Do not use pots or pans with pronounced edges or ridges on the ceramic cooktop. These could scratch the cooktop permanently. See "Selecting cookware" for more information. Grains of salt and sand can also scratch. Make sure that the bases of any pots and pans are clean, free of any fat or oils and are dry.

Do not allow either solid or liquid sugar, pieces of plastic or foil to fall on the burners when they are hot. If these residues are allowed to cool on the ceramic surface pitting or even cracking could occur.

Any spills should be removed as quickly as possible to prevent them from burning on and becoming difficult to remove.

Do not use a steam cleaner to clean the appliance. Steam could penetrate electrical components and cause a short circuit.

Never place hot pots or pans over the touch controls, as the underlying electronics may be damaged.

To prevent damage to the cooktop do not use pans with thin bases on this cooktop. Never heat an empty pan unless the pan manufacturer states that you can do so.

# IMPORTANT SAFETY INSTRUCTIONS

---

## Injury prevention

Do not touch the cooktop or the surrounding areas during or immediately after use. The cooktop may be hot even though it is dark in color. Areas near it may become hot enough to cause burns. Do not touch, or let clothing or other flammable materials touch the cooktop or areas near it until they have cooled. Wait until the residual heat indicators go out.

Children should not be left alone or unattended in an area where a cooktop is in use. Never allow children to sit or stand on any part of the cooktop.

Caution: Do not store items of interest to children in cabinets above a cooktop. Children climbing on the cooktop to reach these items could be injured.

Protect your hands with insulated gloves or potholders when using the appliance. Use only dry, heat resistant potholders. Moist or damp potholders used on hot surfaces can result in steam burns. Do not let the potholder touch the hot heating element. Do not use towels or other bulky items near the appliance.

To prevent burns and breathing difficulty, allow the cooktop to cool before cleaning. Some cleaners may produce toxic fumes if applied to a hot surface.

Keep all pans out of reach of children. Danger of burns!

Pot and pan handles should be turned inward and not extend over the countertop to reduce the risk of burns, ignition of flammable materials, and spills.

Use the proper pan size. Select cookware having flat bottoms large enough to cover the heating element. Using undersized cookware will expose a portion of the heating element to direct contact and may result in ignition of clothing or handles becoming hot. The proper size pot or pan will also improve efficiency.

Before using glass, glass/ceramic, ceramic, earthenware or other glazed cookware on the cooktop, verify that they can be used on a cooking surface.

Do not heat unopened food containers. Built-up pressure may cause the container to burst and result in injury.

At higher settings, be cautious of splattering grease or boiling over liquids, which may produce smoke.

# IMPORTANT SAFETY INSTRUCTIONS

---

- Before removing pots and pans, be sure to turn off the burners.
- Do not store items on the cooktop when not in use. Items could melt or catch fire from residual heat or if the cooktop is turned on inadvertently.
- Never cover the cooktop with a cloth. A fire could result.
- Never leave a cooktop unattended when cooking with oil or fat. Overheated oil could ignite. Always heat oil slowly, monitoring it as it heats.
- Do not use water on grease fires. Smother any fire or flame, or use a dry chemical or foam-type extinguisher.
- When frying food, make sure that the food is as dry as possible before placing it in the oil. Moisture can cause hot oil to splatter and boil over.
- Do not flambé under an exhaust hood. Flames could be drawn up into the hood by the suction or the grease filters may ignite.
- Do not let cooking grease or other flammable materials accumulate on the appliance.
- Be aware of loose fitting or hanging garments when operating the cooktop, they may present a fire hazard.
- Flammable materials should not be stored on or near the appliance.
- If there is a drawer directly underneath the appliance without any wooden base in between, ensure that no aerosols, combustible liquids or other easily flammable materials are kept in it. If cutlery inserts are to be placed in the drawer, they must be made of heat-resistant material.

# IMPORTANT SAFETY INSTRUCTIONS

---

## Appliance safety

■ In the event of any damage to the appliance, it must be turned off immediately and disconnected from the electricity supply by either shutting off the power main or manually "tripping" the circuit breaker. Contact Technical Service.

Do not use the appliance until it has been repaired. Ensure power is not supplied to the appliance until repair work is completed.

■ Do not cook on a broken cooktop. Any breakages or cracks in the ceramic surface of the appliance are defects and must be treated as such. If the cooktop should break, cleaning solutions and spills may penetrate the broken cooktop and create a risk of electric shock.

Do not use the appliance until it has been repaired.

■ Repairs should only be performed by qualified technicians to ensure safety. Repairs and other work by unqualified persons could be dangerous. Under no circumstances open the outer casing of the appliance.

■ While the appliance is under warranty repairs should only be performed by an authorized service technician. Otherwise the warranty is void.

## Further safety notes

■ Make certain that the power cords of small appliances do not come in contact with the cooktop. Danger of electric shock!

■ Always make sure food is cooked thoroughly before eating.

■ Only use cookware suitable for the range-top. Unsuitable cookware may break due to sudden temperature changes.

■ Do not use plastic or aluminium containers. They will melt at high temperatures. Fire hazard!

■ Do not allow children to operate or play with or near the cooktop.

■ If a pet hops onto the cooktop, a touch control sensor could be activated turning on a burner. Keep pets away from the cooktop at all times and activate the child safety lock.

■ Before discarding an old appliance, remove the power cord to prevent hazards.

**SAVE THESE INSTRUCTIONS AND REVIEW THEM PERIODICALLY**



## Disposal of packing materials

The cardboard box and packing materials are biodegradable and recyclable. Please recycle.

## Disposal of an old appliance

Old appliances contain materials that can be recycled. Please contact your local recycling authority about the possibility of recycling these materials.

Before discarding an old appliance, disconnect it from the gas and electrical supply and cut off the power cord to prevent it from becoming a hazard.

# Guide to the cooktop

---

## Cooktop

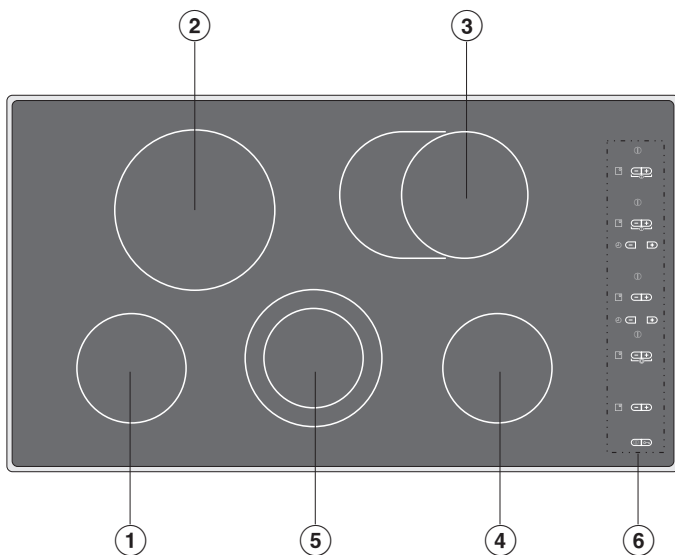

①②④ Single zone

③ Extended zone

⑤ Variable zone

⑥ Control panel

## Control panel

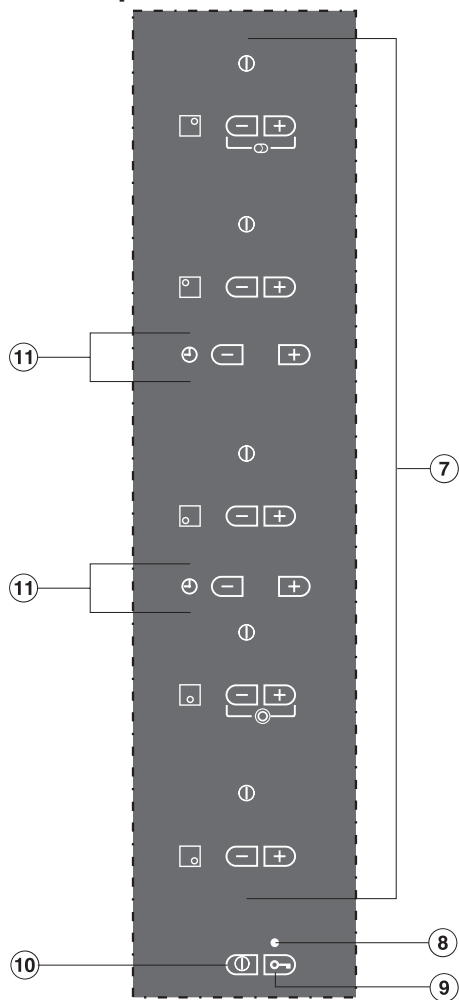

### Touch controls for:

- ⑦ Cooking zone controls  
(see section "Cooking zone controls and displays")
- ⑨ Child safety lock
- ⑩ Cooktop ON/OFF
- ⑪ Timer  
(see "Cooking zone controls and displays")

### Indicator for:

- ⑧ Child safety lock, indicator

# Guide to the cooktop

## Cooking zone controls and displays

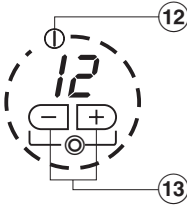

### Touch controls:



- ⑫ Cooktop ON/OFF
- ⑬ for selecting the power settings and turning on the outer circle of the variable zone or extended zone

### Displays

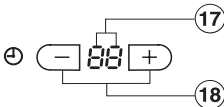
- ⑭ Extended cooking zone on
- ⑮  $\bar{0}$  = Ready for use  
 $1 - 12$  = Power setting  
 $..$ ,  $=$  or  $\bar{3}$  = Residual heat  
 $F$  = Fault (see, "Safety cut-out feature")
- ⑯ Light ring: the number of segments lit corresponds to the selected power setting (exception: see "Cooking with Auto-heat").







### Timer:

Kitchen timer or automatic shut off for rear left  and front left  zones

- ⑰ Time display
- ⑱ Touch controls for setting the timer

## Cooking zones

Cooking zone	KM 451	
	ø in inches (cm)	Rating in watts
	5 <sup>3</sup> / <sub>4</sub> (14.5)	1200
	8 <sup>1</sup> / <sub>4</sub> (21)	2000
	6 <sup>3</sup> / <sub>4</sub> (17) / 6 <sup>3</sup> / <sub>4</sub> x 10 <sup>1</sup> / <sub>2</sub> (17 x 26.5)	1400 / 2200
	5 <sup>3</sup> / <sub>4</sub> (14.5)	1200
	4 <sup>3</sup> / <sub>4</sub> (12) / 7 <sup>1</sup> / <sub>16</sub> (18)	700 / 1700
		Total: 8300

All cooking zones have the auto heat and safety cut-out feature.

# Before using for the first time

---

## Clean the cooktop

Before using for the first time, clean the cooktop with a damp cloth and then dry with a soft cloth.

## Heat the cooktop

The metal components of the cooktop have a protective coating which may give off a slight odor the first time the appliance is heated.

The smell will dissipate after a short time and does not indicate a faulty connection or appliance defect.

## Touch controls

This cooktop has electronic touch controls activated by a finger. There is a separate touch control for each burner. A tone sounds to indicate that contact has been made with a control.

Keep the control area clean and do not rest things on it. The touch control sensors could mistake an item or debris for a finger tip contact, turning the cooktop on or off.

To prevent damage to the electronics never place hot pans on the control panel.

## Turning on the cooktop

The cooktop must be turned on before any of the burners can be used.

- Touch the ① "ON / OFF" touch control for the cooktop.

A horizontal bar will appear in each of the burner displays and 00 will appear in each timer display.

The cooktop is now on and the burners are ready for use. The burners will not heat until a power setting has been chosen.

If a setting is not chosen within 30 seconds the cooktop will turn itself off as a safety measure.

## Turning on a burner

- Once the cooktop is turned on, touch the ① "ON/OFF" control of the burner you wish to use.

A 0 will appear in the burner display.

- Select the desired setting between 1 and 12 by touching the - or + touch controls.

Make sure to touch only one of the controls at a time or they will not respond.

When turning on the cooktop you can decide whether you want to cook with auto heat (see, "Auto heat" for more information) or not:

### Turn on with + to:

Cook **without** auto heat

### Turn on with – to:

Cook **with** auto heat

# Using the cooktop

---

## Cooking without auto heat

### Proceed as follows:

- If 0 is showing in the display, keep the + touch control pressed until the desired power setting shows in the display, e.g. 4:

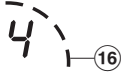

The same number of segments, 16, will show in the light ring, i.e. if setting 4 is selected four segments will light up.



## Cooktop settings

The range of settings is the same for all cooking zones:

Cooking process	Settings
Melting butter, chocolate etc. Dissolving gelatin	1 - 2
Thickening sauces containing egg yolk and butter Warming small quantities of food/liquid Warming sticky foods Cooking rice	1 - 3
Warming liquid and half-set foods Thickening sauces, e.g. Hollandaise Cooking rice pudding Preparing omelettes, lightly fried eggs Steaming fruit	3 - 5
Defrosting deep frozen food Steaming vegetables, fish Cooking dumplings, potatoes, soups Cooking broths	4 - 6
Boiling and continued cooking of large quantities of food	7
Gentle braising (without overheating the fat) of meat, fish, vegetables, fried eggs etc.	8 - 9
Frying pancakes etc.	9 - 11
Boiling large quantities of water	11 - 12

These setting recommendations are only intended as a guide. With deep pans, large quantities or without the lid on, a higher setting is needed. With smaller quantities select a lower setting.

# Using the cooktop

## Auto heat

When auto heat has been activated, the cooking zone turns on automatically at the highest setting and then changes to the continued cooking setting which you have previously selected. The "heat-up" time depends on which continued cooking setting has been chosen (see table).

Continued cooking setting	Heat-up time in minutes
1	0.5
2	2.0
3	2.5
4	3.0
5	4.0
6	6.0
7	9.0
8	2.0
9	2.0
10	2.5
11	2.5
12	-

### How to activate auto heat:

- If **0** shows in the display, touch the - touch control until the continued cooking setting you want appears in the display e.g. **3**.

The **12 segments** show in the light ring, **16**, during the auto heat time. When the heat-up time has finished **only the number of segments**, for the relevant **continued cooking setting** which has been chosen, show in the light ring.

Example:

during the auto heat time:

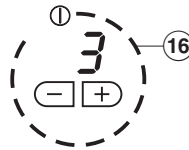

during the continued cooking time:

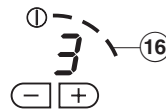

You can increase or decrease the continued cooking setting at any time during the auto heat time with the + or - touch controls. The heat-up time will adjust accordingly.

### How to turn off auto heat before the heat-up time has finished:

- Set the display to **0**.
- Then select the setting you want to continue using by pressing the + touch control.

## Turning on an extended cooking zone

The second circle of a variable cooking zone or the extended cooking zone can be turned on to extend the cooking area for cooking with larger pans.

### Proceed as follows:

- Turn on the cooking zone and select a power setting.
- Press the - and + touch controls **simultaneously**.

When  appears in the cooking zone display the extended cooking zone can be turned on by pressing the - and + touch controls **simultaneously** and then selecting a power setting.

A short segment , will appear in the top left of the ring to indicate that the extended cooking zone has been turned on.

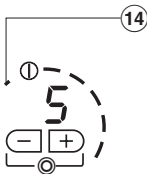

To turn the extended cooking zone off, press the - and + touch controls **simultaneously**. The short segment, , will then go out.

## Turning off a cooking zone

- Touch the ON / OFF control  of the cooking zone you want to turn off.

If the cooking zone is still hot, the residual heat indicator will remain lit until the zone has cooled (see "Residual heat indicator").

# Using the cooktop

---

## To turn off the cooktop

The cooktop can be turned off at any time.

- Touch the ON / OFF touch control ① of the cooktop.

This turns off all cooking zones. The residual heat indicator will light up in the display of any cooking zone that is still hot.

## Residual heat indicator

After the cooking zones or the cooktop have been turned off, the residual heat of the cooking zones which may still be hot are indicated by three stacked horizontal bars in the display:

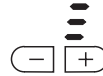

The bars go out one after another as the cooking zones cool down. The last bar only goes out when the cooking zones are safe to touch.

If there is an interruption to the power supply the residual heat indicators will flash on and off.

## Child safety lock

Keep children away from the cooktop for their own safety. In addition, the cooktop has a child safety lock to prevent children from turning on the cooking zones or changing the settings.

The child safety lock can be activated when the cooktop is turned off as well as when it is in use.

If the child safety lock is activated **when the cooktop is turned off** then the cooktop cannot be turned on.

If the child safety lock is activated **when the cooktop is in use** only the **following** are possible:

- The settings for the cooking zones and for the timer cannot be altered.
- The cooking zones, cooktop and timer can still be turned off but once turned off cannot be turned on again.

## To activate the child safety lock:

- Press the touch control for the child safety lock  until the indicator above it lights.

The indicator light will go out after a short while.

The light will come on again to show that the child safety lock has been activated, if:

- you touch the control for the child safety lock .
- you try to select a setting.

## To de-activate the child safety lock:

Press the control for the child safety lock  until the indicator light above it goes out.

# Safety locks

---

## Safety cut-out feature

The cooktop has a safety cut-out feature in case it is not turned off after use.

If one of the burners is heated for an unusually long period of time (see table), and the power settings are not adjusted, the cooktop will turn itself off automatically and the residual heat indicator will light up.

- If you wish to use the burners once again, turn the cooktop back on again in the usual way.

Power setting	Maximum operating hours
1	10
2	5
3	5
4	4
5	4
6	4
7	3
8	3
9	2
10	2
11	2
12	1

## Safety cut-out if the touch controls are covered

The cooktop will turn off automatically if any of the touch controls are covered for more than 10 seconds, for example by finger contact, food boiling over, or by an object such as an oven mitt or towel.

When the cooktop turns itself off a tone will sound every 30 seconds (for a maximum of 10 minutes) and an *F* will flash in the display of the touch control which was covered.



## To reset the touch controls:

- Clean the control area or remove the object covering the touch control.

This will turn off the tone and the *F* will go out.

- Turn the cooktop back on again with the ⓘ "ON / OFF" touch control. The burners can now be used.

# Safety locks

---

## Overheating protection

Each burner is equipped with a temperature limiter. This limiter turns off the heating elements in the burner before the ceramic surface becomes too hot. Once the ceramic surface has cooled to a safe temperature, the heating elements will automatically turn back on.

The overheating protection can be activated by:

- turning on a burner without putting a pan on it.
- heating an empty pan.
- an uneven pan not sitting evenly on the burner.
- the pan not conducting heat properly.

If the heating elements cycle on and off, even at the highest setting, the overheating protection has been activated.



## The cooking surface

Your ceramic cooktop is made of an extremely hard and durable material. The surface is scratch resistant, not scratch proof. Avoid using cookware with ridged bottoms. Ridged pots with dirty or chipped enamel bottoms may scratch the cooktop if they are pulled across the ceramic surface.

Make sure the cooktop and pot bottoms are clean before cooking. Certain items, particularly sugar grains or crystallized liquids such as molasses or syrups are actually harder than ceramic and can scratch the surface if they are not cleaned off immediately. Small or light scratches will not affect the safety or performance of the cooktop however.

The burner rings and touch controls are fused into the ceramic glass and are resistant to wear if properly maintained. Do not use abrasive cleaners or pads, as they may eventually wear off the rings.

## Pots and pans

Special cookware is not required, but as is true with all types of cooking appliances, the better the cookware, the better the performance.

Following these tips will allow you to make the most of your ceramic cooktop.

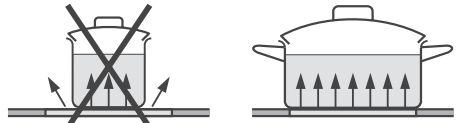

- For the most even and energy efficient cooking, the diameter of the pots should match the diameter of the burners as closely as possible.

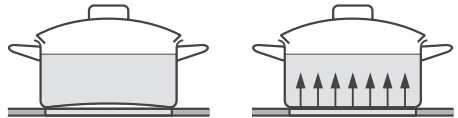

- Use cookware with thick, flat, smooth bottoms. Slightly concave bottoms will also work adequately. Pans with convex bottoms will not cook well.

## Selecting cookware

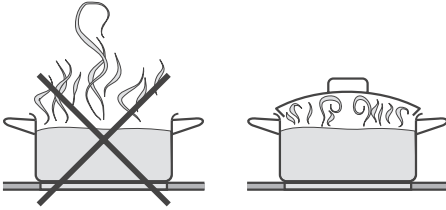

---



- Using a lid while cooking will minimize the loss of heat and decrease the cooking time.
- Copper bottom and aluminum pans may leave a residue on the cooktop in the form of metallic lines. This is normal. These lines can be removed using a non-abrasive ceramic cooktop cleaner or a shielded scraper blade.

Be sure to clean the cooktop after each use. Each time the residue is allowed to melt it becomes harder to remove and may mar the appearance of the cooktop. Let the cooktop cool before cleaning.

- Cast iron, glass or stoneware should not be used because they have poor heat transfer and may scratch the surface.

The cooktop has two timers, one for the rear left cooking zone  and one for the front left cooking zone . They can be used just as a kitchen timer, or for automatically turning one of these cooking zones off.

## To set the timer

The timer can only be used when the **cooktop is turned on**, and the cooking zone belonging to the timer is turned off.

- With the **cooktop turned on** press the - or + touch control for the relevant timer until the desired time appears in the timer display e.g. 15 minutes.

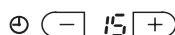

The set time counts down in minutes in the time display. It can be changed at any time by pressing the - or + touch controls. The timer can be set from 1 to 99 minutes.

When the end of the set time has been reached **00** appears in the timer display, and at the same time a tone sounds for about 10 seconds. The **00** will go out after 30 seconds.



The timer can be turned off before the set time has elapsed by pressing the - and + touch controls **simultaneously**.

If the cooking zone belonging to the timer you are using is turned on, the timer will shut off. The time set goes out and **00** will appear in the display.

# Timer

---

## Automatically turning off a cooking zone

Only the rear left  and front left  cooking zones can be programmed to turn off automatically. This function will only work if a power setting has been selected.

### Proceed as follows:

- Select a power setting for the relevant cooking zone.
- Press the - or + touch controls for the relevant timer until the desired time shows in the display, e.g. 15 minutes.

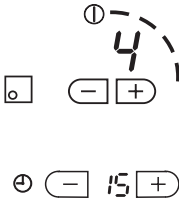

The time set counts down in minutes. The time left to run shows in the timer display. It can be changed at any time by pressing the - or + touch controls. The power setting for the cooking zone can also be changed at any time.

At the end of the selected time the cooking zone turns off automatically. The residual heat indicators will appear in the display for the cooking zone and a **00** in the timer display. At the same time a tone will sound for 10 seconds. The zeros will go out after 30 seconds.

When cleaning the cooktop, make sure the cooktop is "Off", and be careful not to accidentally turn it "On".

Under no circumstances should a steam cleaner be used to clean this appliance. Pressurized steam could cause permanent damage to the surface and to components for which the manufacturer cannot accept responsibility.

Do not use any sharp pointed objects which could damage the seal between the ceramic surface, the surrounding frame and the countertop.

Never use scouring agents, pads, abrasive cleaning agents or strong cleaners, e.g. oven sprays, stain or rust removers, as these could damage the surface of the appliance.

The ceramic surface can be cleaned using a cleaner for ceramic surfaces. Follow the manufacturer's instructions on the packaging.

Make sure that no cleaner residue remains on the ceramic surface by carefully wiping the cooktop with a damp cloth. Cleaner residues could damage the cooktop when heated.

After cleaning, thoroughly dry the ceramic surface with a soft cloth to prevent a build up of limescale deposits.

The ceramic surface should be cleaned regularly with a cleaner for ceramic surfaces. Follow the ceramic cleaner manufacturer's instructions. If you have difficulty locating a suitable product contact Miele's Technical Service Department.

Before cleaning allow the cooktop to cool. Wipe spills off using a damp sponge. Stubborn spills are best removed with a shielded scraper blade.

To remove any limescale deposits or metallic residue apply ceramic cleanser using a soft cloth or use a shielded scraper blade if necessary.

A cleaner with a special additive to prevent water marks and smears on the ceramic surface may be used.

After cleaning, wipe the ceramic surface with a damp cloth to remove any residue. Cleaner residues could damage the cooktop or create toxic fumes when heated. Finally, dry the cooktop with a clean soft cloth.

Any melted solids (e.g. sugar, plastic, syrup, aluminium foil, etc.) should be removed as quickly as possible and while the burner is still warm. If they are allowed to harden, the cooktop may become pitted. Scrape the melted item off the cooktop using a shielded scraper blade. Once the cooktop has cooled, remove any remaining residue using a ceramic cooktop cleaner.

# Frequently asked questions

---

All repairs should be performed by a trained technician in strict accordance with national and local codes. Any repairs or maintenance performed by unqualified personnel could be dangerous and may void the warranty.

**the cooktop turns off while it is in use and the residual heat indicator or a flashing *F* appears in the display for at least one of the cooking zones and at the same time a tone sounds?**

One of the cooking zones has been on for too long, or one of the touch controls may have been covered (see, "Safety cut-out feature").

## What if ...

**the cooktop or cooking zones cannot be turned on?**

Check whether:

- the child safety lock is activated. If necessary, turn it off (see "Child safety lock").
- the electrical circuit has blown a fuse or "tripped" the circuit breaker.

If none of the above is the case, then disconnect the appliance from the electricity supply for 1 minute by "tripping" the circuit breaker, or withdrawing the fuse.

Reconnect the appliance to the electrical supply and if the cooktop still does not heat up, contact a qualified electrician or the Miele Technical Service Department.

**the heating cycles on and off at the highest setting on one of the cooking zones?**

The Overheating protection is activated (see "Overheating protection").

**the contents of the pan are not heating properly using Auto-heat?**

The pan is a bad conductor of heat or too much food is in the pan.

Select a higher continued cooking setting or start by using the highest power setting and then turn to a lower setting.

### **the touch control sensors are over sensitive or do not react at all?**

The sensitivity level of the sensor has been changed.

- Make sure that there is no direct light (from the sun or from an artificial source) hitting the cooktop and that the surrounding area is not too dark.
- Interrupt the power supply to the cooktop for 1 minute by "tripping" the circuit breaker, or withdrawing the fuse.

Reconnect the electricity supply. The electronic unit will have reset the sensitivity level of the touch control sensors.

If this does not solve the problem please call the Miele Technical Service Department.

## Technical Service

---

In the event of a fault which you cannot easily fix yourself, please contact the Miele Technical Service Department.

**USA** 1-800-999-1360  
techserv@mieleusa.com

**CDN** 1-800-565-6435  
service@miele.ca

When contacting Technical Service please quote the serial number and model of the cooktop. This information is visible on the silver data plate supplied with the cooktop.

Adhere data plate sticker here

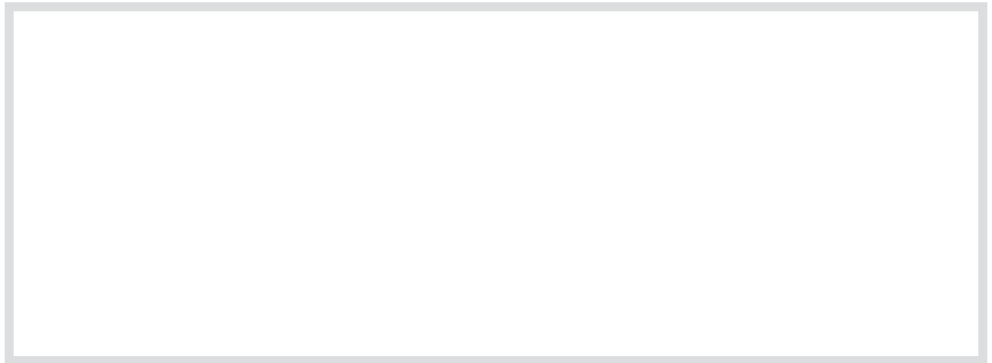









When contacting the Technical Service,  
please quote the model and serial number  
of your appliance.

---

The Miele logo is displayed in a bold, white, serif font against a black rectangular background.

**Miele, Inc.** (USA)

**National Headquarters**

9 Independence Way  
Princeton, NJ 08540  
Phone: 800-843-7231  
609-419-9898  
Fax: 609-419-4298  
[www.mieleusa.com](http://www.mieleusa.com)

**Technical Service & Support**

**Nationwide**

Phone: 800-999-1360  
Fax: 888-586-8056

**Miele Limited** (CDN)

**National Headquarters**

55G East Beaver Creek Road  
Richmond Hill, ON L4B 1E5  
Phone: 800-643-5381  
905-707-1171  
Fax: 905-707-0177  
[www.miele.ca](http://www.miele.ca)  
[info@miele.ca](mailto:info@miele.ca) (general enquiries)  
[professional@miele.ca](mailto:professional@miele.ca) (commercial enquiries)

**Mielecare National Service**

Phone: 800-565-6435  
905-850-7456  
Fax: 905-850-6651  
[service@miele.ca](mailto:service@miele.ca) (Tech. Service)

## Free Manuals Download Website

<http://myh66.com>

<http://usermanuals.us>

<http://www.somanuals.com>

<http://www.4manuals.cc>

<http://www.manual-lib.com>

<http://www.404manual.com>

<http://www.luxmanual.com>

<http://aubethermostatmanual.com>

Golf course search by state

<http://golfingnear.com>

Email search by domain

<http://emailbydomain.com>

Auto manuals search

<http://auto.somanuals.com>

TV manuals search

<http://tv.somanuals.com>