

## Operating and installation instructions

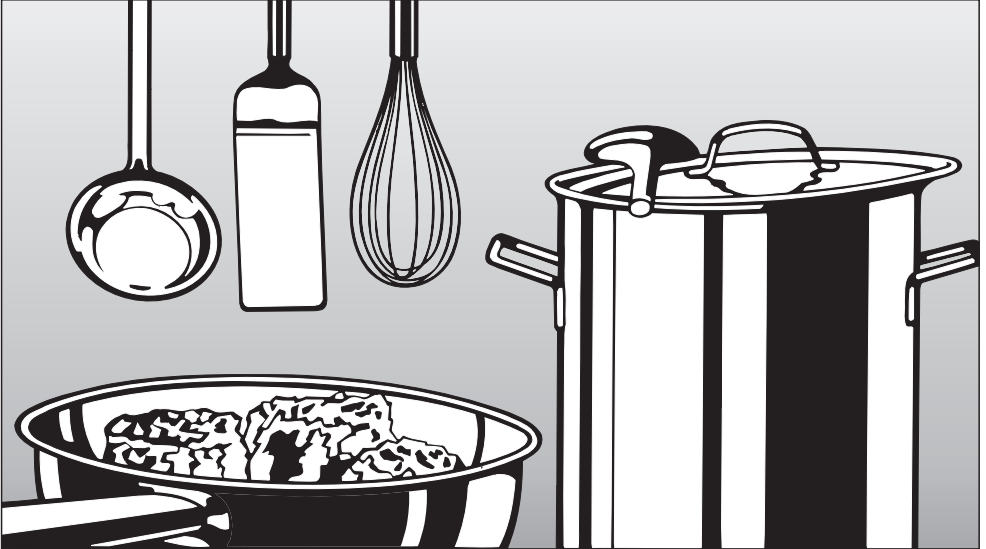

### Ceramic hobs KM 5600 KM 5617

To avoid the risk of accidents or damage to the appliance it is **essential** to read these instructions before it is installed and used for the first time.

en - GB

M.-Nr. 07 570 840

# Contents

---

<b>Guide to the appliance</b> .....	4
Models .....	4
KM 5600 .....	4
KM 5617 .....	5
Control panels .....	6
Cooking zones .....	8
<b>Warning and Safety instructions</b> .....	9
<b>Caring for the environment</b> .....	15
<b>Before using for the first time</b> .....	16
Cleaning for the first time .....	16
Before using for the first time .....	16
<b>How the cooking zones work</b> .....	17
<b>Operation</b> .....	18
How the hob is operated .....	18
Switching on .....	19
Power level range .....	20
Auto heat-up .....	21
Switching the outer circle of a double circle / extended zone on and off .....	23
Switching off and residual heat indicators .....	24
<b>Suitable pans</b> .....	25
<b>Tips on saving energy</b> .....	26
<b>Timer</b> .....	27
Minute minder .....	27
To switch a cooking zone off automatically .....	28
To use both timer functions at the same time .....	29

<b>Safety features</b> . . . . .	30
Safety lock / System lock . . . . .	30
Safety switch-off. . . . .	32
Overheating protection . . . . .	33
<b>Cleaning and care</b> . . . . .	34
<b>Additional functions</b> . . . . .	36
Reset . . . . .	36
Programming . . . . .	37
<b>Problem solving guide</b> . . . . .	39
<b>To test the power level</b> . . . . .	43
<b>Optional accessories</b> . . . . .	45
<b>Safety instructions for installation</b> . . . . .	46
<b>Building-in dimensions</b> . . . . .	51
KM 5600. . . . .	51
KM 5617. . . . .	52
<b>Installation</b> . . . . .	53
<b>Electrical connection</b> . . . . .	56
Wiring diagram . . . . .	57
<b>After sales service, data plate</b> . . . . .	58

# Guide to the appliance

---

## Models

KM 5600

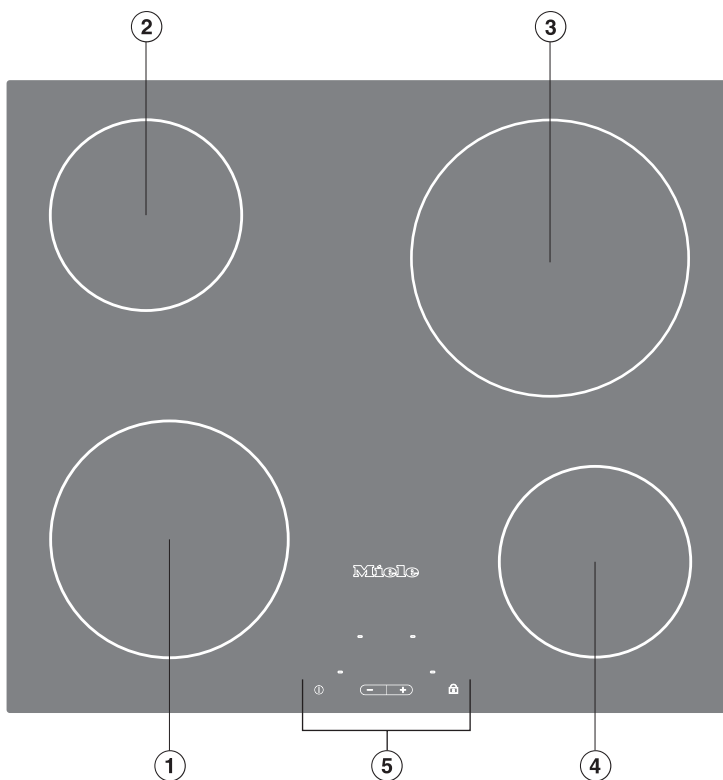

①②③④ Single circle zones

⑤ Control panel

KM 5617

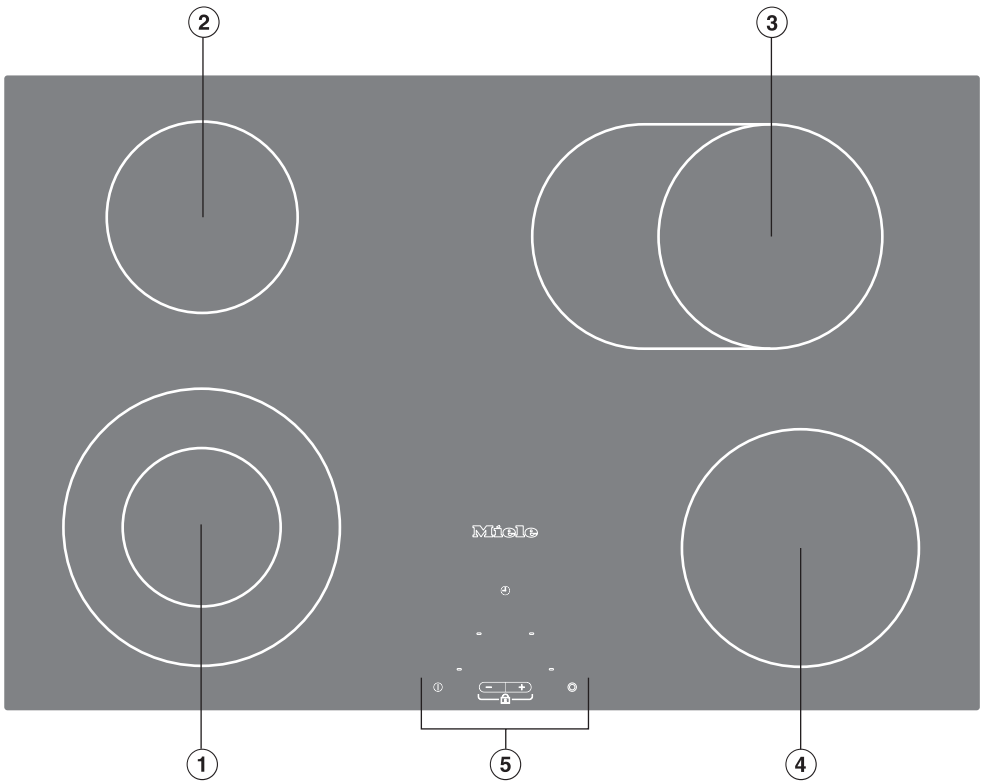

- ① Double circle zone
- ②④ Single circle zones
- ③ Extended cooking zone
- ⑤ Control panel

# Guide to the appliance

## Control panels

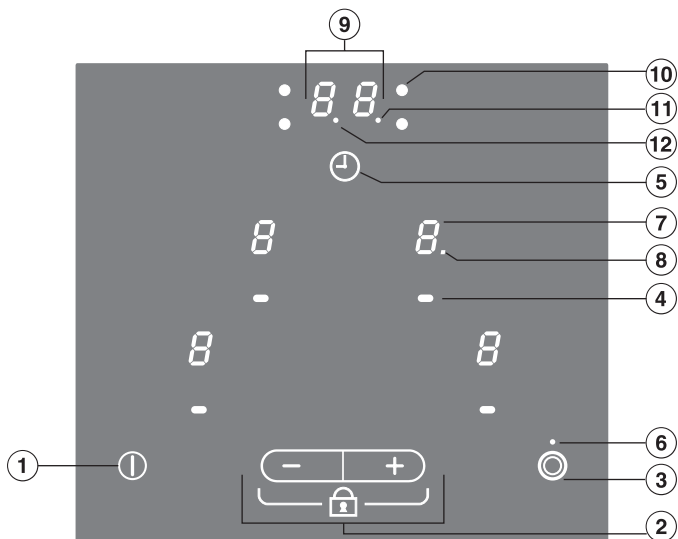

### KM 5617 (Hob with double circle/extended zone)

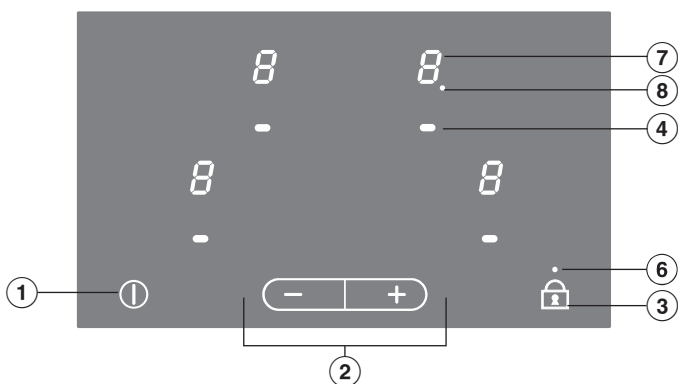

### KM 5600 (Hob with single circle zones only)







## Sensors for

- ① Switching the hob on and off
- ② - Setting the power level
  - Safety lock (on models with double circle/extended zone)
  - Setting the time (on models with a timer)
- ③  Switching on the outer circle of a double circle/extended zone
  -  Safety lock
- ④ Selecting the cooking zone
- ⑤ - Selecting the timer
  - Switching between the timer functions
  - Selecting the switch off time (see "Switching off a cooking zone automatically")

## Indicator lamps

- ⑥ - Safety lock (on models without double circle/extended zone)
  - Outer circle of a double circle/extended zone switched on (on models with double circle/extended zone)

## Cooking zone displays

- ⑦  = Cooking zone ready for use
-  1 to 9 = Power levels
-  = Residual heat
-  *F* = Fault (see "Safety switch-off")
-  *R* = Auto heat-up when the power setting range has been extended
- ⑧ Indicator lamp for Auto heat-up or extended power setting (see "Programming"), e.g. the front left cooking zone





## Timer display





- ⑨ Time
- ⑩ Indicator lamp for relevant zone, e.g. rear right cooking zone
- ⑪ Indicator lamp for minute minder
- ⑫ Indicator lamp for half hours with a minute minder time of more than 99 minutes

# Guide to the appliance

---

## Cooking zones

Zone	KM 5600	
	Ø in cm	Rating in watts for 230 V
	18.0	1800
	14.5	1200
	21.0	2200
	14.5	1200
		Total: 6400

Zone	KM 5617	
	Ø in cm	Rating in watts for 230 V
	12.0 / 21.0	750 / 2200
	14.5	1200
	17.0 / 17.0 x 26.5	1500 / 2400
	18.0	1800
		Total: 7600



# Warning and Safety instructions

This appliance complies with all relevant local and national safety requirements. Inappropriate use can, however, lead to personal injury and damage to property.

To avoid the risk of accidents and damage to the appliance, please read these instructions carefully before installation and before using it for the first time. They contain important notes on installation, safety, use and maintenance.

Keep these instructions in a safe place and ensure that new users are familiar with the content. Pass them on to any future owner.

## Correct application

► This hob is not designed for commercial use. It is intended for use in domestic households and in similar working and residential environments such as:

- Shops
- Offices and showrooms

and by residents in establishments such as:

- Hostels and guest houses.

► The appliance is intended for domestic use only to cook food and keep it warm.

Any other use is not supported by the manufacturer and could be dangerous. Miele cannot be held liable for damage resulting from incorrect or improper use or operation.

► This hob is not intended for outdoor use.

► This appliance is not intended for use by people with reduced physical, sensory or mental capabilities, or lack of experience and knowledge, unless they are supervised whilst using it, or have been shown how to use it by a person responsible for their safety.

# Warning and Safety instructions

---

## Safety with children

▶ Use the safety lock to prevent children operating the appliance or altering the settings.

▶ Keep children away from the appliance at all times. It is not a toy! To avoid the risk of injury, do not allow them to play with it or use the controls. They will not understand the potential dangers posed by it. They should be supervised whenever you are working in the kitchen.

▶ Older children may use the appliance only when its operation has been clearly explained to them and they are able to use it safely, recognising the dangers of misuse.

▶ The appliance gets hot when in use and remains hot for quite a while after being switched off. To safeguard against burning, keep children well away from the appliance at all times.

▶ Do not store anything which might arouse a child's interest in storage areas above or next to the hob. Otherwise they could be tempted into climbing onto the appliance with the risk of burning themselves.

▶ Keep all pans out of reach of children. Turn pan handles inwards away from the edge of the hob. Danger of burning or scalding. Special hob guards are available from good retail outlets.

▶ Packaging, e.g. cling film, polystyrene and plastic wrappings, must be kept out of the reach of babies and young children. Danger of suffocation. Dispose of or recycle all packaging safely as soon as possible.

## Technical safety

► Before installation, check the appliance for visible signs of damage. Do not install and use a damaged appliance. It could be dangerous.

► The electrical safety of this appliance can only be guaranteed if correctly earthed. It is most important that this basic safety requirement is observed and regularly tested, and where there is any doubt, the electrical system in the house should be inspected by a qualified electrician. Miele cannot be held liable for the consequences of an inadequate earthing system (e.g. electric shock).

► Before connecting the appliance, make sure that the connection data on the data plate (voltage and frequency) match the mains electricity supply. This data must correspond in order to avoid the risk of damage to the appliance. Consult a qualified electrician if in any doubt.

► For safety reasons, this appliance may only be used after it has been built in.

► Do not open the casing of the appliance. Tampering with electrical connections or components and mechanical parts is highly dangerous to the user and can cause operational faults.

► Installation, maintenance and repairs may only be carried out by a suitably qualified and competent person in strict accordance with current national and local safety regulations. Repairs and other work by unqualified persons could be dangerous. Miele cannot be held liable for unauthorised work.

► During installation, maintenance and repair work, the appliance must be disconnected from the mains electricity supply. Ensure that power is not supplied to the appliance until after it has been installed or until after any maintenance or repair work has been carried out.

► While the appliance is under guarantee, repairs should only be undertaken by a service technician authorised by Miele. Otherwise the guarantee is invalidated.

► Faulty components must only be replaced by genuine Miele original spare parts. The manufacturer can only guarantee the safety of the appliance when Miele replacement parts are used.

► If the connection cable is damaged, it must be replaced by a suitably qualified electrician with a specialist connection cable of type H 05 V V-F (pvc insulated), available from Miele.

# Warning and Safety instructions

---

▶ Do not connect the appliance to the mains electricity supply by a multi-socket adapter or an extension lead. These do not guarantee the required safety of the appliance (e.g. danger of overheating).

▶ Do not use the hob if it is faulty, or if the ceramic surface is cracked, chipped or damaged in any way. Switch it off immediately, and disconnect it from the mains electricity supply. Danger of electric shock.

▶ In areas which may be subject to infestation by cockroaches or other vermin, pay particular attention to keeping the appliance and its surroundings in a clean condition at all times. Any damage caused by cockroaches or other vermin will not be covered by the guarantee.

## Correct use

▶ The appliance gets hot when in use and remains hot for quite a while after being switched off. There is a danger of burning until the residual heat indicators go out.

▶ Do not leave the appliance unattended whilst it is in use. Pans that have boiled dry can cause damage to the ceramic surface for which Miele cannot be held liable. Boiling fat or oil could ignite and cause a fire.

▶ If oil or fat does catch fire, do not attempt to put out the flames with water. Use a suitable fire blanket, saucepan lid, damp towel or similar to smother the flames.

▶ Do not use the appliance to heat up the room. Due to the high temperatures radiated, objects near the appliance could catch fire. The life of the appliance could also be reduced.

▶ The control panel and the hob frame or hob edges (on hobs with bevelled edges) can become hot due to the influence of the following factors: operating duration, high power level(s), large pans and the number of cooking zones being used.

▶ Use heat-resistant pot holders or gloves when using the appliance. Do not let them get damp or wet, as this causes heat to transfer through the material more quickly with the risk of scalding or burning yourself.

# Warning and Safety instructions

---

- ▶ Do not flambé under a cooker hood. The flames could set the cooker hood on fire.
- ▶ Do not use the appliance as a resting place for anything else. When the appliance is switched on either deliberately or by mistake, or when there is residual heat present, there is the risk of metal objects heating up, with a danger of burning. Depending on the material, other objects left on the hob could also melt or catch fire. Damp pan lids might adhere to the ceramic surface and be difficult to dislodge. Switch the cooking zones off after use.
- ▶ Do not cover the appliance, e.g. with a cloth, kitchen foil, etc. This could be a fire hazard if the appliance is switched on by mistake.
- ▶ Do not use plastic or aluminium foil containers. These melt at high temperatures and could catch fire.
- ▶ Do not heat up unopened tins of food on the hob, as pressure will build up in the tin, causing it to explode. This could result in injury and scalding or damage.
- ▶ Do not use pots and pans on the ceramic hob with bases with pronounced edges or ridges, e.g. cast iron pans. These could scratch or scour the hob surface permanently.
- ▶ Aluminium pans or pans with an aluminium base can cause metallic, shiny marks to appear on the ceramic surface. These marks can be removed using a ceramic and stainless steel hob cleaner (see "Cleaning and care").
- ▶ Never heat an empty pan unless the manufacturer of the pan expressly states that you can do so. This could damage the appliance.
- ▶ Keep the hob clean. Grains of salt, sugar and sand (e.g. from cleaning vegetables) can cause scratches.
- ▶ Never place hot pans on the area around the controls. The electronic unit underneath could get damaged.
- ▶ Do not drop anything on the ceramic surface. Even a light object could cause damage in certain circumstances.
- ▶ To prevent the risk of spillages etc. burning on, remove any soiling as quickly as possible and ensure that pan bases are clean, dry and free of grease.
- ▶ Do not allow either solid or liquid sugar, or pieces of plastic or aluminium foil to get onto the cooking zones when they are hot. If this should occur, switch off the appliance, and carefully scrape off all the sugar, plastic or aluminium residues from the hob whilst they are still hot, using a shielded scraper blade. Take care not to burn yourself. If residues are allowed to cool before being removed, the ceramic surface would be susceptible to pitting or even cracking. Clean the appliance once it has cooled down.

## Warning and Safety instructions

---

▶ When using an electrical appliance, e.g. a hand-held food blender, near the appliance, ensure that the cable of the electrical appliance cannot come into contact with the hot appliance. The insulation on the cable could become damaged, giving rise to an electric shock hazard.

▶ Spray canisters, aerosols and other inflammable substances should not be stored in a drawer under the hob. Cutlery inserts must be heat-resistant.

▶ Always ensure that food is sufficiently cooked or reheated. Some foods may contain micro-organisms which are only destroyed by thorough cooking at a sufficiently high temperature for long enough. Therefore, when cooking or reheating food such as poultry, it is particularly important that the food is completely cooked through. If in doubt, select a longer cooking or reheating time.

▶ If the appliance is installed behind a kitchen furniture door, it may only be used with the furniture door open. Only close the door when the appliance is switched off and the residual heat indicators have gone out.

Miele cannot be held liable for damage caused by non-compliance with these Warning and Safety instructions.

### Disposal of the packing material

The transport and protective packing has been selected from materials which are environmentally friendly for disposal, and should be recycled.

Ensure that any plastic wrappings, bags, etc. are disposed of safely and kept out of the reach of babies and young children. Danger of suffocation.

### Disposal of your old appliance

Electrical and electronic appliances often contain materials which, if handled or disposed of incorrectly could be potentially hazardous to human health and to the environment. They are, however, essential for the correct functioning of your appliance. Please do not therefore dispose of it with your household waste.

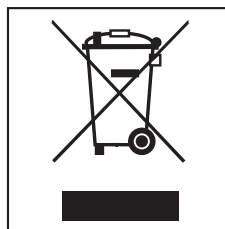

Please dispose of it at your local community waste collection/recycling centre or contact your dealer for advice. Ensure that it presents no danger to children while being stored for disposal.

## Before using for the first time

---

Please stick the extra data plate for the appliance supplied with this documentation in the space provided in the "After sales service, data plate" section of this booklet.

### Cleaning for the first time

- Remove any protective wrapping and adhesive labels.
- Before using for the first time, clean the appliance with a damp cloth only and then wipe dry.

### Before using for the first time

On hobs with bevelled glass edges, a small gap may be visible between the hob and the worktop during the first few days after installation. This gap will reduce with time as the appliance is used and will not affect the electrical safety of your appliance.

The metal components have a protective coating which may give off a slight smell when heated up for the first time.

The smell and any vapours given off do not indicate a faulty connection or appliance, and they are not harmful to health.



# How the cooking zones work

Single circle cooking zones have one heating element, whilst double circle (vario) cooking zones and extended zones have two. Depending on model, the heating elements may be separated by an isolating ring.

Each cooking zone has overheating protection (a temperature limiter), which stops the ceramic surface from becoming too hot (see "Overheating protection").

When a power level is selected, the heat switches on and the element can be seen through the ceramic surface.

The temperature of the cooking zones depends on the power level selected, and is electronically regulated. This controls the "timing" of a cooking zone, switching the element on and off.

## Single circle zone

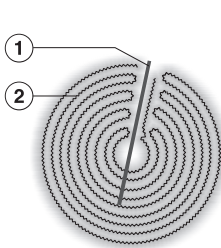

- ① Overheating protection
- ② Heating element

## Double circle zone

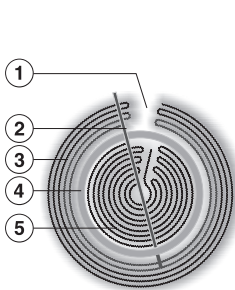

- ① Intentional gap
- ② Overheating protection
- ③ Outer heating element
- ④ Isolating ring
- ⑤ Inner heating element

# Operation

---

## How the hob is operated

The hob is equipped with electronic sensor controls which react to finger contact.

To operate the hob, touch the relevant sensor. Each time you touch a sensor, an audible tone sounds.

In order to set or alter a power level or the time, the cooking zones and the timer must be "active".

To activate a cooking zone or the timer, touch the sensor for selecting the relevant cooking zone or the timer. After you have touched the sensor, the relevant cooking zone or timer display will start to flash. The cooking zone or the timer is "active" whilst the display is flashing and you can set a power level or time.

Take care to keep the control panel clean and do not place anything on top of it. The sensors may fail to react or they could mistake the article or any dirt for a fingertip contact, thereby activating a function or even causing the hob to switch off automatically (see "Safety switch-off".)

Never place hot pans on the sensors. The electronic unit underneath could get damaged.



## Switching on

The hob must be switched on before any of the zones can be used.

Do not leave the appliance unattended whilst it is being used.

### To switch the hob on

- Touch the  sensor.

 will appear in each of the cooking zone displays.  will appear in the timer display. If no further entry is made, the hob will switch itself off after a few seconds for safety reasons.

### Switching on a cooking zone, setting a power level

- Touch the sensor for selecting the cooking zone you want.

A  will flash in the cooking zone display.

- Whilst the  is flashing, select a power level of between **1** and **9** by touching the - or + sensor.



To select cooking **with** Auto heat-up, press the - sensor first (see "Auto heat-up"). To select cooking **without** Auto heat-up, press the + sensor first.

The power level selected flashes in the display for a few seconds to start with and then lights up constantly.

### Altering the power level

- Touch the sensor for selecting the cooking zone you want.

The power level will flash.

- Touch the + or - sensor to set the power level you want.



# Operation

## Power level range

The appliance is delivered with 9 power levels programmed in. If you wish to fine tune a setting, you can extend the power level range (see "Programming"). The intermediate setting will be represented by an illuminated dot next to the number.

Cooking process	Power levels*	
	Standard factory settings (9 power levels)	Extended settings (17 power levels)
Melting butter, chocolate etc. Dissolving gelatine Preparing yoghurt	1 - 2	1 - 2.
Thickening sauces containing egg yolk and butter Warming small quantities of food/liquid Keeping warm food which sticks easily Cooking rice	1 - 3	1 - 3.
Warming liquid and semi-solid foods Thickening sauces, e.g. Hollandaise Making porridge Preparing omelettes, lightly fried eggs Steaming fruit	2 - 4	2 - 4.
Defrosting deep frozen food Steaming vegetables, fish Cooking dumplings, potatoes, pulses Cooking broths, pulse soups	3 - 5	3 - 5.
Bringing to the boil and continued cooking of large quantities of food	5	5.
Gentle braising (without overheating the fat) of meat, fish, vegetables, fried eggs etc.	6 - 7	6 - 7.
Frying pancakes etc.	7 - 8	7 - 8.
Boiling large quantities of water Bringing to the boil	8 - 9	8. - 9

\* These power levels, which envisage approx. 4 servings, should only be taken as a guide. With deep pans, larger quantities or when cooking without a lid, a higher setting is required. For smaller quantities, select a lower setting.

## Auto heat-up

When Auto heat-up has been activated, the cooking zone switches on automatically at the highest power setting and then switches to the continued cooking setting selected. The heat-up time depends on which continued cooking setting has been chosen (see chart).

As the higher continued cooking settings are generally used for frying food, only a relatively short heat-up time is needed to heat up the pan initially.

## Activating

- Touch the sensor for selecting the cooking zone you want.

The cooking zone display will flash.



- Press the - sensor until the required continued cooking setting appears, e.g. 6.

During the heat-up time an indicator lamp to the right of the continued cooking setting will light up, and go out at the end of it.

In the **extended** range of power settings (see "Programming"), *H* flashes alternately with the continued cooking setting during the heat-up time.

Altering the continued cooking setting will deactivate auto heat-up.

## Deactivating

You can switch off auto heat-up before the auto heat-up time has finished.

- Touch the sensor for selecting the cooking zone you want.

The power level will flash.

- Select a different power level.

# Operation

---

<b>Continued cooking setting*</b>	<b>Heat-up time in minutes and seconds (approx.)</b>
1	1 : 20
1.	2 : 00
2	2 : 45
2.	3 : 25
3	4 : 05
3.	4 : 45
4	5 : 30
4.	6 : 10
5	6 : 50
5.	7 : 10
6	1 : 20
6.	2 : 00
7	2 : 45
7.	2 : 45
8	2 : 45
8.	2 : 45
9	-

\* The continued cooking settings with a dot after the number are only available if the power level range has been extended (see "Programming").

## Switching the outer circle of a double circle / extended zone on and off

When cooking with larger pans, the outer circle of a double circle/extended zone (see "Guide to the appliance") can be switched on to provide an extended cooking area.

When the outer circle of a double circle/extended zone has been switched on, the indicator lamp will light up while the power level is flashing in the cooking zone display. The indicator lamp will go out when the power level lights up constantly in the display.

The extended cooking area will switch off when the cooking zone is switched off.

### To switch on

- Touch the sensor for selecting the cooking zone you want.
- Select the power level you require.
- While the power level is flashing, touch the  sensor.

### To switch off

- Touch the sensor for selecting the cooking zone you want.

The power level and the indicator lamp for the outer circle of a double circle/extended zone will flash.

- Touch the  sensor repeatedly until the indicator lamp goes out.

# Operation

---

## Switching off and residual heat indicators

### Switching off a cooking zone

- Touch the sensor for selecting the cooking zone you want twice.

A  will flash in the cooking zone display for a few seconds. If the cooking zone is still hot, the residual heat indicator will then appear in the display.

### Switching off the hob

- Touch the  sensor.

This switches off all cooking zones. The residual heat indicator will appear in the display of any cooking zone which is still hot.

### Residual heat indicators

The lines of the residual heat indicator go out one after another as the cooking zone cools down. The last horizontal line only goes out when the cooking zone is safe to touch.

Do not touch or place any heat-sensitive objects on the cooking zones while the residual heat indicators are on. Danger of burning and fire hazard.

If there is an interruption to the power supply, the residual heat indicators will flash on and off.



– **Most suitable**

The best pans for use on a ceramic hob are those with a thick base which is very slightly concave when cold. When heated, the base flattens to rest evenly on the hob, optimising the conduction of the heat.

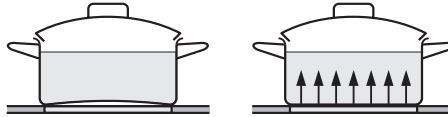

cold

hot

– **Less suitable**

Pans made of glass, ceramic or stoneware are less suitable, as they do not conduct the heat so well.

– **Not suitable**

Dishes or containers made from plastic or aluminium foil must not be used as these melt at high temperatures.

- Aluminium pans or pans with an aluminium base can cause metallic, shiny marks to appear on the ceramic surface. These marks can be removed using a ceramic and stainless steel hob cleaner (see "Cleaning and care").
- Do not use pots and pans on the ceramic hob with bases with pronounced edges or ridges, e.g. cast iron pans. These could scratch or scour the hob surface permanently.
- Lift pans into position on the hob. Sliding them into place can cause scuffs and scratches.
- Often the maximum diameter quoted by manufacturers refers to the diameter of the top rim of the pot or pan. The diameter of the base (generally smaller) is more important.

## Tips on saving energy

---

- Check that the diameter of the pan base is wide enough for the cooking zone so that heat is not lost unnecessarily.



too small

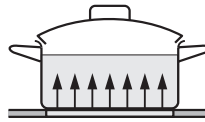

suitable

- Use a pan lid whenever possible to minimise heat loss.



uncovered

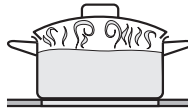

covered

- Select a smaller pan when cooking small quantities. A small pan on a small cooking zone uses less energy than a large, partially filled pan on a large cooking zone.
- Cook with as little water as possible.
- Once food has come to the boil or the oil in the pan is hot enough for frying, reduce the heat to a lower setting.
- When cooking for a long time, switch the cooking zone off about 5 to 10 minutes before the end of the cooking time. In this way, use is made of the residual heat.
- Cooking times are greatly reduced when using a pressure cooker.

The hob must be switched on to use the timer.

The timer can be used for two different functions:

- to set the minute minder
- to set a cooking zone to switch off automatically.

You can select a time from 1 minute (**01**) to 9<sup>1</sup>/<sub>2</sub> hours (**9.h**). If a time of more than 99 minutes (**99**) is set, the time is set in half-hour steps. The half hour is indicated by a dot after the number.

Use the **-** sensor to reduce the time from **9.h** to **00**, and the **+** sensor to increase the time from **00** to **9.h**. The display stops at 2h and at 99. To continue entering the setting, briefly remove your finger from the sensor, and then touch it again.

When the set time has elapsed, **00** will appear in the timer display for a few seconds. An audible tone will sound at the same time for a few seconds. To turn the audible tone off before this, touch the **⊖** sensor.

## Minute minder

### To set the minute minder time

- Touch the **⊖** sensor.

**00** and the minute minder indicator lamp will flash in the timer display.

- Touch the **-** or **+** sensor until the time you require appears in the display, e.g. 15 minutes.

The time set will then count down in minutes. The time remaining will be shown in the timer display.

### To change the minute minder time

- Touch the **⊖** sensor.
- Touch the **-** or **+** sensor to set the time you want.

### To delete the minute minder time

- Touch the **⊖** sensor.
- Touch the **-** and **+** sensors at the same time.

# Timer

---

## To switch a cooking zone off automatically

You can set a time at the end of which a cooking zone will switch off automatically.  
All the cooking zones can be programmed at the same time.

If the time programmed is longer than the maximum operational time allowed, the cooking zone will switch off after the maximum time allowed (see "Safety switch-off").

- Select a power level for the cooking zone you require.
- Touch the ⊖ sensor.

00 and the minute minder indicator lamp will flash in the timer display.

- Touch the ⊖ sensor again.

The minute minder indicator lamp in the timer display will go out and one of the cooking zone indicator lamps will flash.

- If several cooking zones are switched on, touch the ⊖ sensor repeatedly until the indicator lamp for the cooking zone you wish to use this function for, e.g. back right, flashes.

The indicator lamps for the cooking zones which are switched on light up clockwise, starting with the front left.

- Touch the - or + sensor until the time you require appears in the display, e.g. 15 minutes.

15 ☀

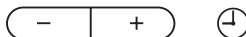

The time set will then count down in minutes. The time remaining will be shown in the timer display.

If you want to set another cooking zone to switch off automatically, follow the same steps as described above.

If more than one switch-off time is programmed, the shortest time remaining will show in the display, and the indicator lamp for that particular cooking zone will flash. All the other indicator lamps will light up constantly. If you want to check on the time remaining for another zone, touch the ⊖ sensor repeatedly until the indicator lamp for the zone you require flashes.

## To change the automatic switch-off time

- Touch the ⊖ sensor repeatedly until the indicator lamp you require flashes.
- Touch the - or + sensor to set the time you want.

## To use both timer functions at the same time

The minute minder and automatic switch-off functions can be used at the same time.

If you have programmed in one or more switch-off times, and would like to use the **minute minder as well**:

Touch the ⊖ sensor repeatedly until the minute minder indicator lamp flashes.

If you are using the minute minder, and would like to programme in one or more **switch-off times as well**:

Touch the ⊖ sensor repeatedly until the indicator lamp for the cooking zone you require flashes.

Shortly after the last entry, the timer display will switch to showing the shortest time remaining.

If you want to see the time remaining for other cooking zones, touch the ⊖ repeatedly until the relevant indicator lamp flashes.

Starting with the shortest time remaining which is shown in the display, all cooking zones which are switched on and the minute minder are selected clockwise.

# Safety features

---

## Safety lock / System lock

Keep children away from the hob for their own safety. Your appliance is equipped with a safety lock and a system lock to prevent the hob and the cooking zones being switched on or any settings being altered.

The **safety lock** is activated when the hob is switched on. If the safety lock is activated:

- The cooking zone power levels and the timer settings cannot be changed.
- The cooking zones, the hob and the timer can be switched off, but once switched off cannot be switched on again.

The **system lock** is activated when the hob is switched off. If the system lock is activated, the hob cannot be switched on and the timer cannot be used.

The hob is programmed in such a way that activating the system lock has to be done manually. The setting can be changed so that the system lock is activated automatically five minutes after the hob has been switched off (see "Programming").

When the safety lock or the system lock is activated and a sensor which is not permitted is touched,

- **L** will appear in the display for the front left cooking zone and **L** will appear in the display for the front right cooking zone for approx. 3 seconds.
- the tone (which sounds when a sensor is touched) sounds for longer than normal (hobs with a double circle/extended zone)
- the indicator lamp lights up (hobs with single circle zones only)

If there is an interruption to the power supply, the safety lock and the system lock will be deactivated.

## Hobs with single circle zones only

### Activating

- Touch the  sensor until the relevant indicator lamp comes on and a tone sounds.

The indicator lamp will go out after a short while.

### Deactivating

- Touch the  sensor until the indicator lamp goes out.

## Hobs with a double circle/extended zone

### Activating

- Touch the - and + sensors **at the same time** until a long tone sounds.

### Deactivating

- Touch the - and + sensors **at the same time** until a tone sounds.

# Safety features

---

## Safety switch-off

### Safety switch-off with an over-long cooking time

If one of the cooking zones is heated for an unusually long period of time (see chart) and the power level is not altered, the hob will switch itself off automatically and the relevant residual heat indicator will light up.

To use the cooking zone again, switch it back on in the usual way.

Power level*	Maximum operating time in hours
1 / 1.	10
2 / 2.	5
3 / 3.	5
4 / 4.	4
5 / 5.	3
6 / 6.	2
7 / 7.	2
8 / 8.	2
9	1

\* The power levels with a dot after the number are only available if the power level range has been extended (see "Programming").

### Safety switch-off if the sensors are covered

Your hob will switch off automatically if one or several of the sensors remain covered for more than about 13 seconds, for example by finger contact, food boiling over, or by an object such as an oven glove or a tea towel.

An **F** will flash in each of the cooking zone displays. At the same time a tone will sound every 30 seconds (for a maximum of 10 minutes).

■ Clean the control panel or remove the obstruction.

This will turn off the tone and the **F** will go out. You can now use the hob again.



## Overheating protection

### Cooking zones

Each zone is equipped with overheating protection (internal temperature limiter). This switches off the heating elements in the cooking zone before the ceramic surface overheats.

If the heating element switches on and off even when the highest power level is selected, this indicates that the overheating protection mechanism has triggered.

Once the ceramic surface has cooled down to a safe level, the heating element will automatically switch back on again.

Overheating can be caused by:

- a cooking zone being switched on without a pan on it.
- heating up an empty pan.
- the base of a pan not sitting evenly on the cooking zone.
- the pan not conducting heat properly.

### Control panel

The control panel electronic unit is equipped with overheating protection. This switches off the hob automatically before the electronic unit overheats.

The fault code *FE37* will appear.

Once the electronic unit has cooled down sufficiently, the fault code will go out and you can use the hob again.

Overheating can occur if several cooking zones are heated at a high power level for a long period of time.

## Cleaning and care

---

For Miele branded cleaning and conditioning products see "Optional accessories".

 Do not use a steam cleaning appliance to clean this appliance. The steam could reach electrical components and cause a short circuit.

The appliance should be cleaned after each use. Let it cool down to room temperature before cleaning.  
To avoid water marks and limescale deposits, use a soft cloth to dry surfaces that have been cleaned with water.

### **To avoid damaging the surface of your appliance, do not use:**

- washing-up liquid,
- cleaning agents containing soda, alkalines, ammonia, acids or chlorides,
- cleaning agents containing descaling agents,
- stain or rust removers,
- abrasive cleaning agents, e.g. powder cleaners and cream cleaners,
- solvent-based cleaning agents,
- dishwasher cleaner,
- grill and oven cleaners,
- glass cleaning agents,
- hard, abrasive brushes or sponges, e.g. pot scourers, brushes or sponges which have been previously used with abrasive cleaning agents,
- melamine eraser blocks,
- sharp, pointed objects which could damage the seal between the ceramic surface and the surrounding frame, and between the frame and the worktop.

Do not use washing-up liquid to clean the ceramic surface. Washing-up liquid will not remove all soiling and deposits. It will form an invisible coating which will cause permanent discolouration of the ceramic surface.  
Clean the hob regularly with a suitable ceramic hob cleaner.

Wipe all coarse soiling off using a damp cloth. Stubborn soiling may need to be removed with a shielded scraper blade.

Then clean the hob with Miele ceramic and stainless steel hob cleaner (see "Optional accessories") applied with kitchen paper or a clean cloth. Do not apply cleaner whilst the hob is still hot, as this could result in marking. Please follow the manufacturer's instructions.

Finally, wipe the hob with a damp cloth, then polish with a soft, dry cloth. Ensure that all cleaner residues are removed. Residues can burn onto the hob the next time it is used, and cause damage to the ceramic surface.

**Spots** caused by limescale, water and aluminium residues (spots with a metallic appearance) can be removed using Miele's ceramic and stainless steel hob cleaner.

Should any **sugar, plastic or aluminium foil** spill or fall onto a hot cooking zone while it is in use, first switch off the appliance. Then carefully scrape off all the sugar, plastic or aluminium residues from the hob whilst they are still hot, using a shielded scraper blade. Take care not to burn yourself.

Allow the appliance to cool down, and then clean as described above.

# Additional functions

---

## Reset

The hob has a reset function. This allows you to restore all settings changed using the programming function to their original factory default settings.

### To activate the reset function

- Switch the hob on.
- Touch the sensors for selecting the front left and front right cooking zones at the same time for 10 seconds.

## Programming

You can change the default settings of programme options (see chart). Several settings can be altered in succession.

After programming mode has been called up, **P** (Programme), **5** (Status) and numbers will appear in the cooking zone displays. These show the current settings.

### To call up programming mode

- With the hob switched off, touch the ① and 🔒 or ② sensors at the same time until the relevant indicator lamp flashes.

### To set a programme / status setting

- Touch the sensor for selecting the **front left** cooking zone.
- Touch the **+** or **-** sensor to set the required **Programme** setting.
- Touch the sensor for the **front right** cooking zone.
- Touch the **+** or **-** sensor to set the required **Status** setting.

### To save settings

- Touch the ① sensor until all the displays go out.

### To not save settings

- Touch the 🔒 or ② sensor until all the displays go out.

## Additional functions

Programme*	Status**	Setting
<b>P 0</b> Demonstration mode and factory default settings	S 0	Demonstration mode on (after the hob is switched on, "d" will appear in the front left cooking zone display and "E" in the front right cooking display for a few seconds).
	<b>S 1</b>	Demonstration mode off
	S 9	Factory default settings reinstated
<b>P 2</b> Power level range	<b>S 0</b>	9 power levels/settings (1, 2, 3 ... to 9)
	S 1	17 power levels/settings (1, 1., 2, 2., 3 ... to 9) If the Auto heat-up setting is selected, an <i>H</i> will flash alternately with the continued cooking setting in the display.
<b>P 4</b> Keypad tone when a sensor is touched	S 0	Off
	S 1	Quiet
	<b>S 2</b>	Medium
	S 3	Loud
<b>P 5</b> Audible tone for the timer	S 0	Off
	S 1	Quiet audible tone on for 10 seconds
	<b>S 2</b>	Medium audible tone on for 10 seconds
	S 3	Loud audible tone, on for 10 seconds
<b>P 7</b> System lock	<b>S 0</b>	Manual activation of the system lock
	S 1	Automatic activation of the system lock
<b>P 6.</b> Sensor reaction speed	S 0	Slow
	<b>S 1</b>	Normal
	S 2	Rapid

\* Programme /Status numbers not shown here have no allocation.

\*\* The factory default settings are shown in bold.

## Problem solving guide

With the help of the following notes, minor faults in the performance of the appliance, some of which may result from incorrect operation can be put right without contacting the Service Department.

 Installation work and repairs to electrical appliances must only be carried out by a suitably qualified and competent person in strict accordance with current local and national safety regulations (BS 7671 in the UK). Repairs and other work by unqualified persons could be dangerous. The manufacturer cannot be held liable for unauthorised work.

Problem	Possible cause	Remedy
<b>The hob or cooking zones cannot be switched on.</b>	The system lock is activated.	Deactivate the system lock (see "Safety lock / System lock").
	The mains fuse has tripped.	Reset the trip switch in the mains fuse box (minimum fuse rating - see data plate).
	There may be a technical fault.	Disconnect the appliance from the electricity supply for approx. 1 minute. – switch off at the wall socket and withdraw the plug, or – switch off at the isolator, or  – disconnect the mains fuse.  Reset the trip switch in the mains fuse box, and switch the appliance back on. If it still will not switch on, contact a qualified electrician or the Miele Service Department.

## Problem solving guide

---

Problem	Possible cause	Remedy
<b>After the hob is switched on "d" appears in the front left cooking zone display and "E" appears in the front right cooking zone display. The cooking zones do not heat up.</b>	The appliance is in demonstration mode.	Deactivate demonstration mode (see "Programming").
<b>The hob switches off while it is use.</b>	One of the cooking zones has probably been on for too long.	No remedy necessary. You can use the cooking zones again by switching them back on (see "Safety switch-off").
<b>The heating element for one of the cooking zones switches on and off.</b>	Power levels 1 to 8: This is not a fault.	No remedy necessary. This is quite normal, and due to the electronic regulation of the temperature (see "How the cooking zones work").
	Power level 9: This indicates a fault. The overheating protection mechanism for one of the cooking zones has triggered.	No remedy necessary. Once the ceramic surface has cooled down to a safe level, the heating element will automatically switch back on again (see "Overheating protection").



## Problem solving guide

Problem	Possible cause	Remedy
<b>The hob switches off while it is in use, an <i>F</i> appears in every cooking zone display and a tone sounds.</b>	One or more of the sensors have been covered, e.g. by finger contact, food boiling over or by an object such as an oven glove.	Clean the control panel or remove the obstruction (see "Safety switch-off").
<b>The food in the pan hardly heats up or does not heat up at all when the Auto heat-up function is switched on.</b>	There is too much food in the pan.	Start cooking at the highest power level and then turn down to a lower one manually later on.
	The pan is not conducting heat properly.	Use a different pan.
<b>One or more residual heat indicators are flashing.</b>	There was an interruption to the power supply during operation, and the hob has switched itself off.	No remedy necessary. The hob can be used again. Check how well the food is cooked and whether it has been affected by the power failure before switching the cooking zone(s) back on again.
	The residual heat indicators have lit up during programming.	No remedy necessary. The indicators will flash until the maximum residual heat time has elapsed or the cooking zone is switched on.
<b>It is taking too long for the contents of the pan to come to the boil.</b>		You can test the power level of the cooking zone (see "To test the power level").

# Problem solving guide

Problem	Possible cause	Remedy
<b>The sensors are over-sensitive or do not react at all.</b>	The sensitivity level of the sensors has changed.	Make sure that there is no direct light (from the sun or from an artificial source) falling onto the hob and that the surrounding area is not too dark. Make sure that there is nothing covering the sensors or the hob. Take any pans off the hob and wipe away any food deposits. Interrupt the power supply to the hob for approx. 1 minute. If this does not solve the problem, please call the Miele Service department.
<b>An <i>F</i> lights up in the rear left cooking zone display and an <i>E</i> lights up in the rear right cooking zone display and numbers appear in the displays at the front.</b>		
<b>left      right</b>		
<b>9          0</b>	A calibration fault has occurred after the reset function has been activated or after an interruption to the power supply. If the displays do not go out after 5 minutes, proceed as described under "Remedy" on the right.	
<b>9          1</b>		
<b>9          2</b>		
<b>9          3</b>		
<b>3          7</b>	The overheating protection mechanism for the control panel has triggered.	No remedy necessary. You can use the hob again as soon as the fault code goes out (see "Overheating protection").
<b>All other fault codes</b>	A fault with the electronics has occurred.	Interrupt the power supply to the hob for approx. 1 minute. If the problem persists after reconnecting the appliance to the power supply, please contact the Miele Service department.

## To test the power level

---

You can test the power level of a cooking zone by measuring how long it takes to bring a specific amount of water to the boil.

The pan (and lid) must be stainless steel or enamel. The diameter of the pan must match the cooking zone, and be flat-bottomed or slightly concave.

- Take a note of the diameter and wattage of the cooking zone to be tested (see "Guide to the appliance - Cooking zones").
- Fill the pan with the quantity of water given in the table. The temperature of the water should be approx. 20°C.
- Put the lid on the pan and place the pan on the cooking zone.
- Switch on the cooking zone at the highest power level.
- Note the time it takes for the water to boil.

The power level for the cooking zone is correct if the water boils within the time given in the table.

The time can vary if:

- there is low or excess voltage.
- very cold water is used.
- an unsuitable pan is used.
- the pan is not covered.

## To test the power level

---

<b>∅ Cooking zone in cm</b>	<b>Rating in watts for 230 V</b>	<b>Quantity of water in litres</b>	<b>Time* in minutes</b>
10.0	600	0.5	11.0
12.0	700 / 750	1.0	13.0
14.5	1000 / 1100	1.0	9.0
14.5	1200	1.0	8.5
14.5	1350	1.0	8.0
17.0	1500	1.5	9.5
18.0	1250	1.5	11.0
18.0	1700 / 1800	1.5	9.0
21.0	2000	2.0	10.5
21.0	2200 / 2300	2.0	9.5
23.0	2500	2.0	9.0
27.0	2700	3.0	13.0
27.0	3200	3.0	12.0

\* Max. time under unfavourable conditions

## Optional accessories

---

Miele offer a comprehensive range of useful accessories as well as cleaning and conditioning products for your appliance.

These products can be ordered online:



or from Miele (see back cover for contact details)

### **Ceramic and stainless steel hob cleaner** **250 ml**



Removes heavy soiling, limescale deposits and aluminium residues.

### **E-cloth (microfibre cloth)**

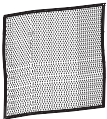

Removes finger marks and light soiling.

# Safety instructions for installation

---

The appliance must only be installed and connected to the electricity supply by a suitably qualified and competent person in strict accordance with current national and local safety regulations.

Fit the wall units and extractor hood before fitting the hob to avoid damaging the appliance.

► The veneer or laminate coatings of worktops (or adjacent kitchen units) must be treated with 100 °C heat-resistant adhesive which will not dissolve or distort.

Any backmoulds must be of heat-resistant material.

► This appliance must not be used in a non-stationary location (e.g. on a ship).

► The hob may not be built in over a fridge, fridge freezer, freezer, dishwasher, washing machine or tumble dryer.

► After installing the hob, ensure that the connection cable cannot come into contact with the underside of the appliance. Make sure that there is no mechanical obstruction, such as a drawer, which could damage it.

► Observe carefully the safety distances given on the following pages.

All dimensions in this instruction booklet are given in mm.

# Safety instructions for installation

## Safety distance above an interim shelf

It is not necessary to fit an interim shelf underneath the hob.

If an interim shelf is fitted underneath the hob, a minimum safety distance of 110 mm must be maintained between the top of the worktop and the top of the interim shelf.

A gap of at least 10 mm must be provided between the rear edge of the interim shelf and the back panel of the housing unit to allow the mains cable to be fed through.

If the hob has an external mains connection box, this gap must be at least 30 mm.

## Safety distance above the hob

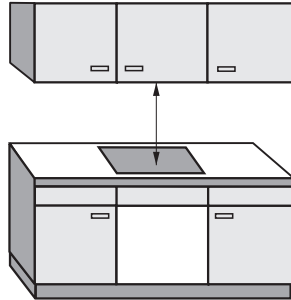

A minimum safety distance must be maintained between the appliance and the cooker hood above it. See the cooker hood manufacturer's operating and installation instructions for details.

If the manufacturer's instructions are not available for the cooker hood, a minimum safety distance of at least 760 mm must be maintained. For any flammable objects, e.g. utensil rails, wall units etc. a minimum distance of at least 760 mm must be maintained between them and the appliance below.

When two or more appliances are installed together below a cooker hood, e.g. a gas wok and a ceramic hob, which have different safety distances given in the installation instructions, you should select the greater distance of the two.

# Safety instructions for installation

## Safety distances to the sides and back of the hob

Ideally the hob should be installed with plenty of space on either side. There may be a wall at the rear and a tall unit or wall on one side (right **or** left) (see illustrations).

- ① Minimum distance of 50 mm between the **back** of the worktop cut-out and the rear edge of the worktop.
- ② Minimum distance of 50 mm between the **right** of the worktop cut-out and the nearest piece of furniture (e.g. tall unit) or a wall.
- ③ Minimum distance of 50 mm between the **left** of the worktop cut-out and the nearest piece of furniture (e.g. tall unit) or a wall.

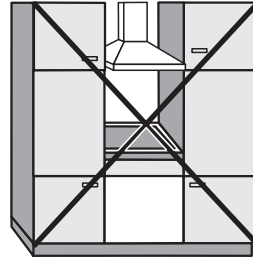

Not allowed

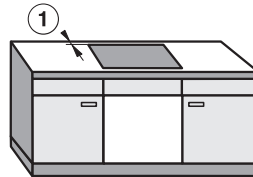

Recommended

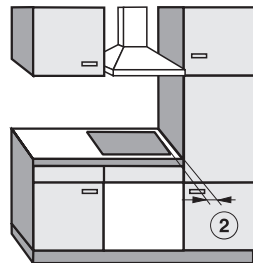

Not recommended

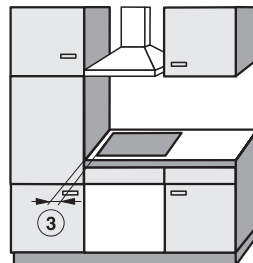

Not recommended



# Safety instructions for installation

## Safety distance when installing the appliance near a wall with additional niche cladding

A minimum safety distance must be maintained between the worktop cut-out and any niche cladding to protect it from heat damage.

If the niche cladding is made from a **combustible material** (e. g. wood) a minimum safety distance ⑤ of 50 mm must be maintained between the cut-out and the cladding.

If the niche cladding is made from a **non-combustible material** (e. g. metal, natural stone, ceramic tiles) a minimum safety distance ⑤ of 50 mm less the thickness of the cladding must be maintained between the cut-out and the cladding.

Example: 15 mm niche cladding

50 mm - 15 mm = minimum safety distance of 35 mm

### Flush-fitted hobs

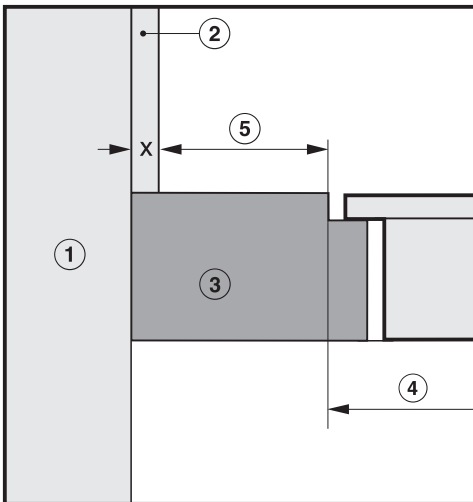

### Hob with frame or bevelled edges

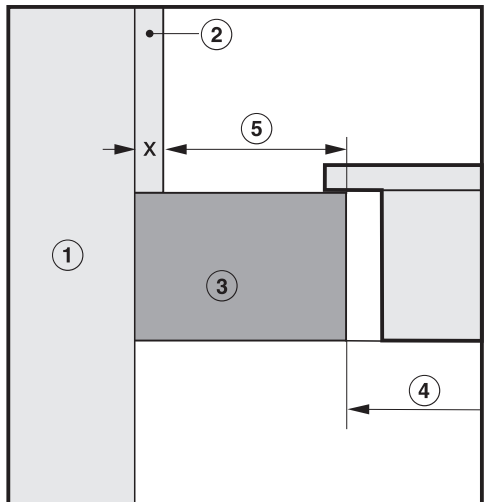

① Masonry

② Niche cladding

Dimension x = thickness of niche cladding material

③ Worktop

④ Worktop cut-out

⑤ Minimum safety distance

for **combustible** materials is 50 mm

for **non-combustible** materials is 50 mm less dimension x

# Safety instructions for installation

## Hob with frame or bevelled edges

### Seal between the hob and the worktop

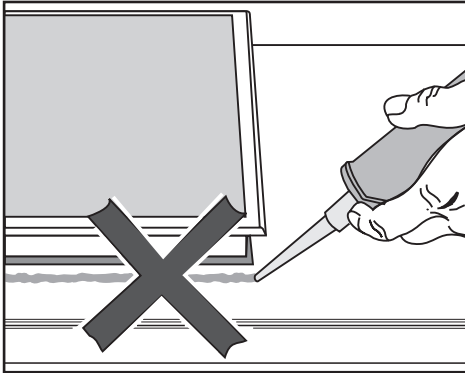

The sealing strip under the edge of the top part of the appliance provides a sufficient seal for the worktop.

The hob must not be sealed with sealant (e.g. silicone). This could result in damage to the hob or the worktop if the hob ever needs to be removed for servicing.

## Tiled worktop

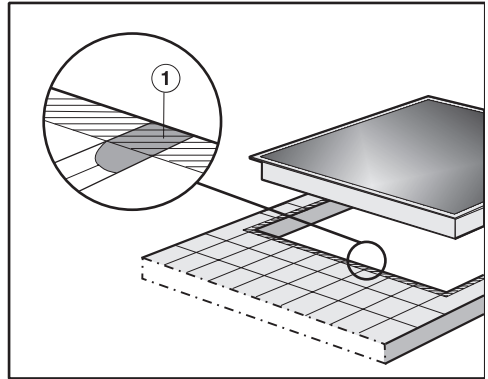

Grout lines ① and the hatched area underneath the hob frame must be smooth and even. If they are not the hob will not sit flush with the worktop and the sealing strip underneath the hob will not provide a good seal between the hob and the worktop.

## KM 5600

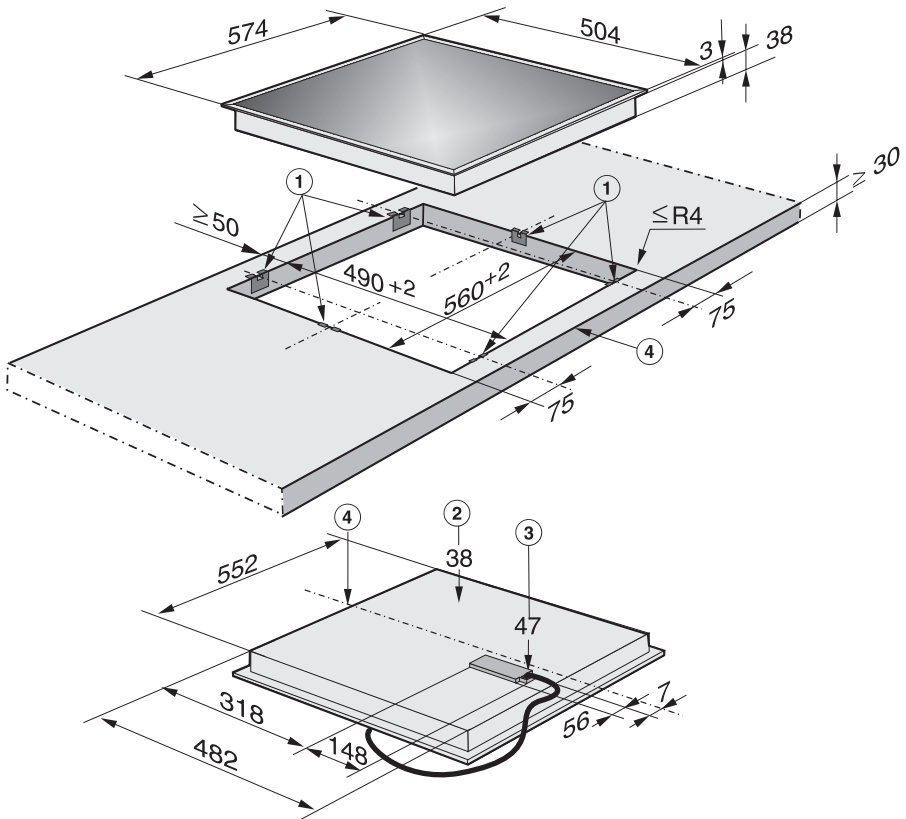

# Building-in dimensions

## KM 5617

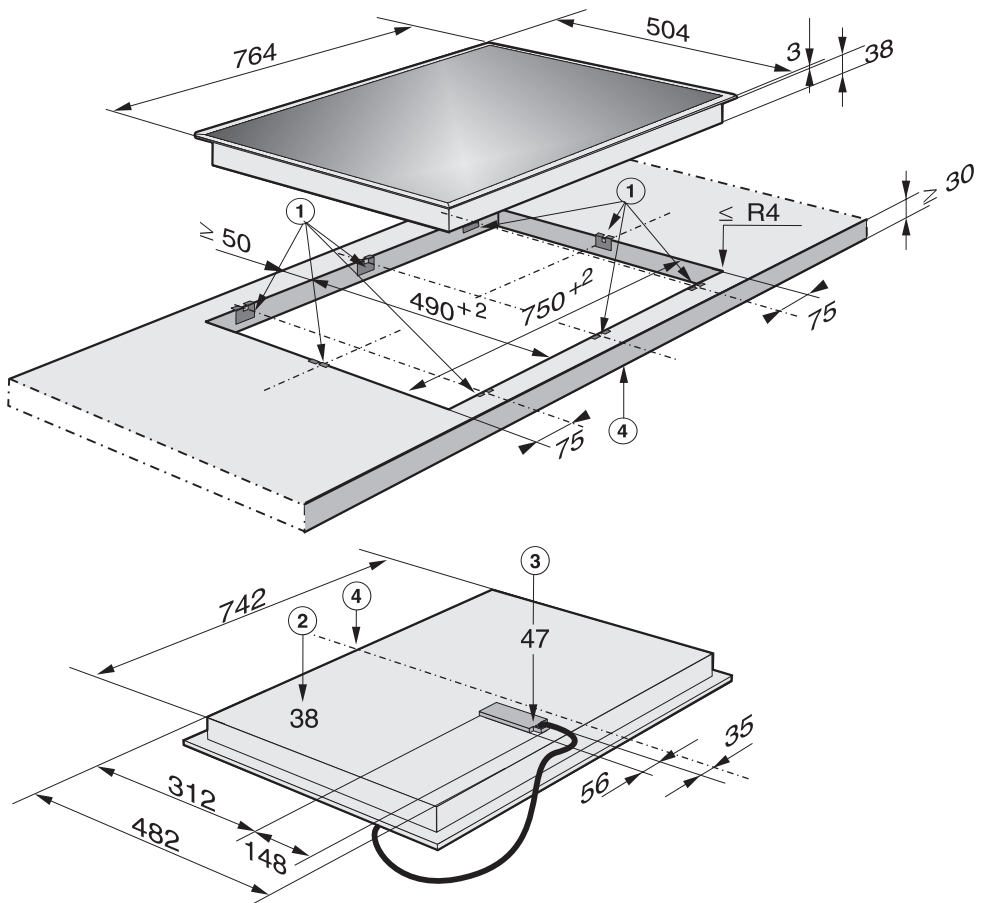

- ① Spring clamps
- ② Casing depth
- ③ Building-in depth including mains connection box.  
Mains connection cable, L = 1440 mm
- ④ Front

The exact positions of the spring clamps, and the safety brackets for hobs with bevelled edges, are shown in the building-in dimensions for the particular hob.

Hobs with bevelled edges:  
The sealing strip will ensure that the hob sits securely in the cut-out. Any gap between the frame and worktop will reduce with time.

- Make the worktop cut-out according to the dimensions given in the building-in dimensions. Remember to maintain the **minimum safety distances** (see "Safety instructions for installation").

## Worktops made of wood

- Seal the cut surfaces with a suitable heat-resistant sealant to avoid swelling caused by moisture.

Make sure that the sealant does not come into contact with the top of the worktop.

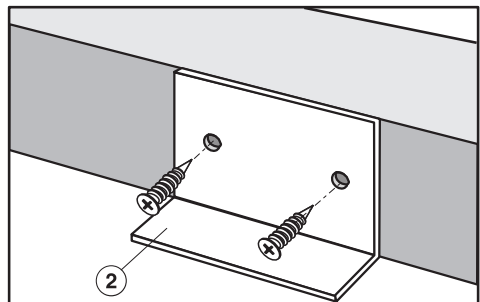
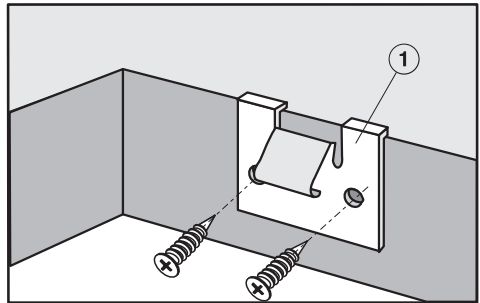

- Depending on model, place spring clamps ① (supplied) on the upper edge of the cut-out or for hobs with bevelled edges, safety brackets ② (supplied) flush with the upper edge of the cut-out.
- Secure the spring clamps ① or safety brackets ② using the 3.5 x 25 mm wood screws supplied.

# Installation

## Granite and marble worktops

You will require double-sided tape and silicone (not supplied).

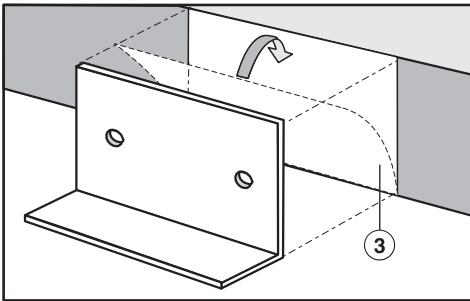
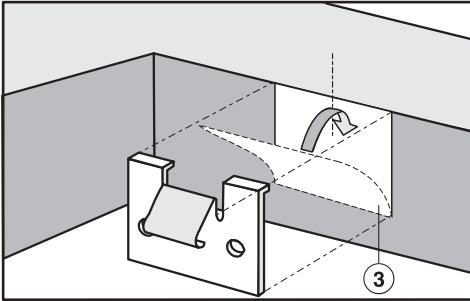

- Fix the spring clamps (or safety brackets for hobs with bevelled edges) in place using double-sided tape ③.

The spring clamps must rest on the top edge of the cut-out and the safety brackets must be flush with the top edge of the cut-out.

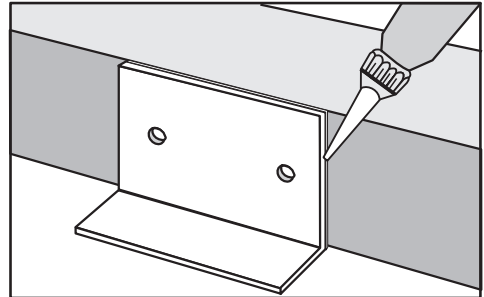
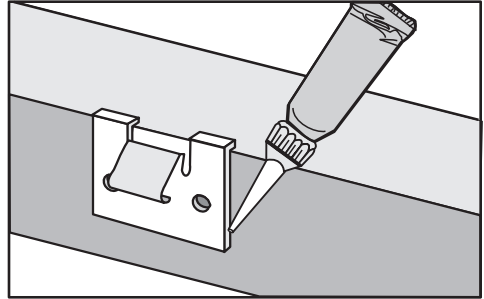

- Apply silicone to the side edges and the lower edges of the spring clamps and safety brackets.

## Installing the hob

- Feed the hob connection cable down through the cut-out.
- Position the hob on the spring clamps.
- Using both hands, press down evenly on the sides of the hob until it clicks into position. When doing this, make sure that the seal under the hob sits flush with the worktop on all sides. This is important to ensure an effective seal all round.  
Do not use sealant (e.g. silicone).

If the corners of the frame are not flush with the worktop surface, the corner radius ( $\leq R4$ ) can be carefully scribed to fit.

- Connect the hob to the mains.
- Check that the hob works.

The hob can now only be removed with a special tool.

## Electrical connection

---

All electrical work should be carried out by a suitably qualified and competent person, in strict accordance with current local and national safety regulations (BS 7671 in the UK).

Installation, repairs and other work by unqualified persons could be dangerous. The manufacturer cannot be held liable for unauthorised work.

A damaged cable must be replaced by a suitably qualified electrician with a special connection cable of type H 05 VV-F, available from Miele.

Ensure power is not supplied to the appliance until after installation or repair work has been carried out.

The appliance must only be operated when built-in. This is to ensure that all electrical parts are shielded. Live parts must not be exposed.

Do not connect the appliance to the mains electricity supply by an extension lead. These do not guarantee the required safety of the appliance.

Connection should be made via a suitable isolator which complies with national and local safety regulations, and the On/Off switch should be easily accessible after the appliance has been built in.

If the switch is not accessible after installation (depending on country) an additional means of disconnection must be provided for all poles.

For extra safety it is advisable to protect the appliance with a residual current device (RCD). Please contact a qualified electrician for advice.

When switched off there must be an all-pole contact gap of at least 3 mm in the isolator switch (including switch, fuses and relays).

### Important U.K.

The appliance is supplied for connection to a 230-240 V, 50 Hz supply with a 3-core cable.

The wires in the mains lead are coloured in accordance with the following code:

Green/yellow = earth

Blue = neutral

Brown = live

**WARNING**  
**THIS APPLIANCE MUST BE**  
**EARTHED**

Please make sure that the connection data quoted on the data plate match the household mains supply.



The electrical safety of this appliance can only be guaranteed when continuity is complete between it and an effective earthing system, which complies with current local and national safety regulations. It is most important that this basic safety requirement is present and regularly tested and where there is any doubt, the electrical wiring in the home should be inspected by a qualified electrician. The manufacturer cannot be held liable for the consequences of an inadequate earthing system such as an electric shock.

The manufacturer cannot be held liable for damage which is the direct or indirect result of incorrect installation or connection.

## Wiring diagram

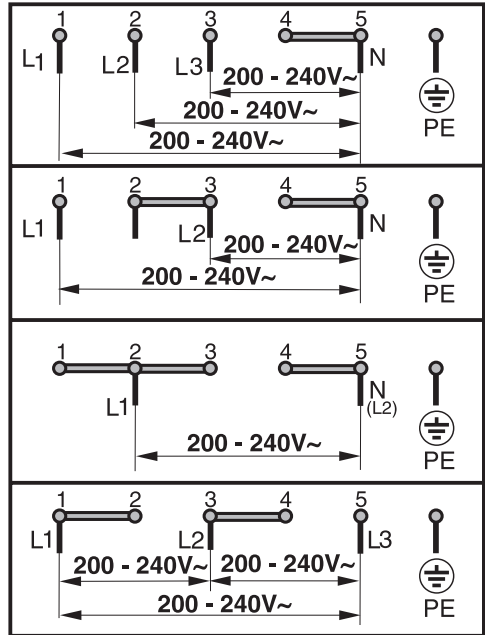

**N.B. This appliance is supplied single phase only in the U.K. / AUS / NZ**

## After sales service, data plate

---

In the event of any faults which you cannot remedy yourself, or if the appliance is under guarantee, please contact:

- Your Miele dealer, or
- the Miele Service Department (see back cover for address).

Please note that telephone calls may be monitored and recorded to improve our service.

When contacting Miele, please quote the model and serial number of your appliance. These are given on the data plate.

N.B. A call-out charge will be applied for service visits where the problem could have been resolved as described in these instructions.

Space in which to stick the extra data plate supplied with the appliance. Ensure that the model number is the same as the one on the front of these instructions.

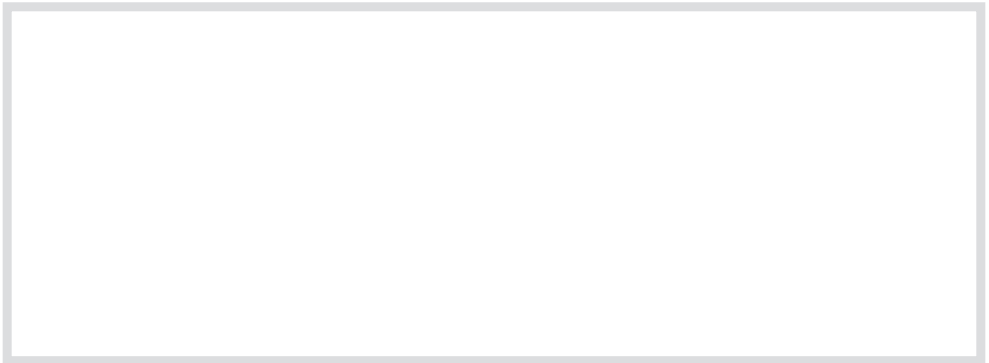



## United Kingdom

Miele Co. Ltd.  
Fairacres, Marcham Road  
Abingdon, Oxon, OX14 1TW  
Tel: 0845 365 0555  
Fax: 0845 365 0777  
Customer Contact Centre Tel: 0845 365 6600  
E-mail: [info@miele.co.uk](mailto:info@miele.co.uk)  
Internet: [www.miele.co.uk](http://www.miele.co.uk)

## Australia

Miele Australia Pty. Ltd.  
ABN 96 005 635 398  
1 Gilbert Park Drive, Knoxfield, VIC 3180  
Tel: (03) 9764 7130, Fax: (03) 9764 7149  
Internet: [www.miele.com.au](http://www.miele.com.au)

## China

Miele (Shanghai) Trading Ltd.  
1-3 Floor, No. 82 Shi Men Yi Road  
Jing' an District  
200040 Shanghai, PRC  
Tel: +86 21 6157 3500  
Fax: +86 21 6157 3511  
E-mail: [mieleshanghai@cn.miele.com](mailto:mieleshanghai@cn.miele.com)  
Internet: [www.miele.cn](http://www.miele.cn)

## Miele (Hong Kong) Limited

41/F - 4101, Manhattan Place  
23 Wang Tai Road  
Kowloon Bay  
Hong Kong  
Tel: (852) 2610 1331  
Fax: (852) 2610 1013  
Email: [mielehk@miele.com.hk](mailto:mielehk@miele.com.hk)

## India

Miele India Pvt. Ltd.  
Ground Floor, Copia Corporate Suites  
Plot No. 9, Jasola  
New Delhi - 110025  
Tel: 011-46 900 000, Fax: 011-46 900 001  
E-mail: [customercare@miele.in](mailto:customercare@miele.in)  
Internet: [www.miele.in](http://www.miele.in)

**Manufacturer:** Germany - Miele & Cie. KG  
Carl-Miele-Straße 29, 33332 Gütersloh



## Ireland

Miele Ireland Ltd.  
2024 Bianconi Avenue  
Citywest Business Campus, Dublin 24  
Tel: (01) 461 07 10, Fax: (01) 461 07 97  
E-Mail: [info@miele.ie](mailto:info@miele.ie), Internet: [www.miele.ie](http://www.miele.ie)

## New Zealand

Miele New Zealand Limited  
Unit L, 10-20 Sylvia Park Road  
Mt. Wellington, 1060, Auckland, NZ  
Tel: 0800 264 353, Fax: 0800 463 453  
Internet: [www.miele.co.nz](http://www.miele.co.nz)

## Singapore

Miele Southeast Asia  
Miele Pte. Ltd.  
163 Penang Road  
# 04 - 02/03 Winsland House II  
Singapore 238463  
Tel: +65 6735 1191, Fax: +65 6735 1161  
E-Mail: [infosea@miele.com.sg](mailto:infosea@miele.com.sg)  
Internet: [www.miele.sg](http://www.miele.sg)

## South Africa

Miele (Pty) Ltd  
63 Peter Place, Bryanston 2194  
P.O. Box 69434, Bryanston 2021  
Tel: +27 (0) 11 548-1900  
Fax: +27 (0) 11 548-1935  
E-mail: [info@miele.co.za](mailto:info@miele.co.za)  
Internet: [www.miele.co.za](http://www.miele.co.za)

## United Arab Emirates

Miele Appliances Ltd.  
P.O. Box 11 47 82  
Gold & Diamond Park  
Sheikh Zayed Road  
Building 6 / Offices Nos. 6-214 to 6-220  
Dubai  
Tel: +971-4-341 84 44  
Fax: +971-4-341 88 52  
E-Mail: [info@miele.ae](mailto:info@miele.ae)  
Internet: [www.miele.ae](http://www.miele.ae)

## Free Manuals Download Website

<http://myh66.com>

<http://usermanuals.us>

<http://www.somanuals.com>

<http://www.4manuals.cc>

<http://www.manual-lib.com>

<http://www.404manual.com>

<http://www.luxmanual.com>

<http://aubethermostatmanual.com>

Golf course search by state

<http://golfingnear.com>

Email search by domain

<http://emailbydomain.com>

Auto manuals search

<http://auto.somanuals.com>

TV manuals search

<http://tv.somanuals.com>