

## Operating instructions

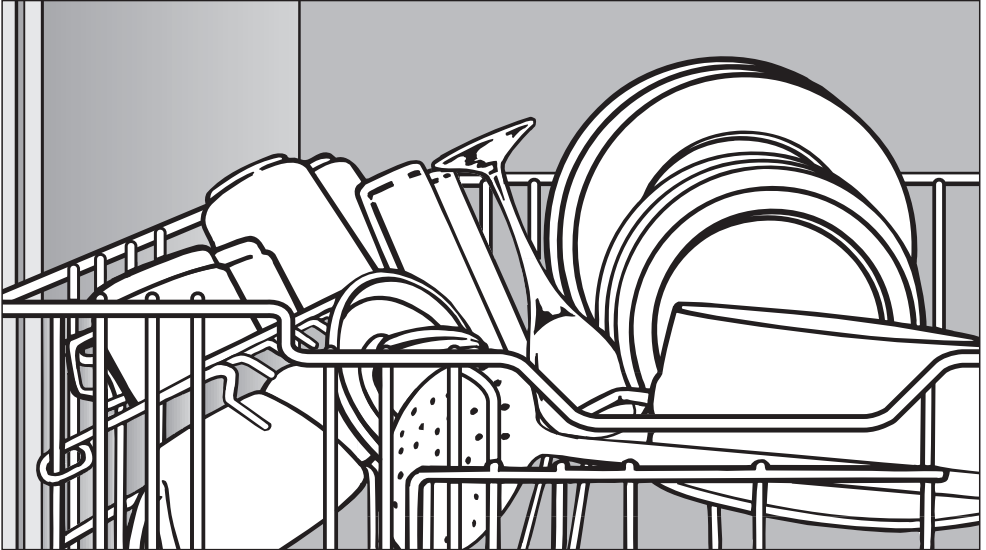

for dishwashers

It is **essential** to read the operating and installation instructions before installing, commissioning or using the machine, to avoid the risk of accidents or damage to the machine.



M.-Nr. 05 714 400

# Contents

---

<b>Guide to the appliance</b> . . . . .	4
Appliance overview . . . . .	4
Control panel . . . . .	5
<b>Warning and Safety instructions</b> . . . . .	6
<b>Caring for the environment</b> . . . . .	10
Disposal of the packing material . . . . .	10
Disposal of your old appliance . . . . .	10
Energy saving washing . . . . .	10
<b>Before using for the first time</b> . . . . .	11
Before using the appliance for the first time you require: . . . . .	11
To open the door . . . . .	12
To close the door . . . . .	12
Child safety lock . . . . .	12
Water softener . . . . .	13
Programming the water hardness level . . . . .	14
Checking the programmed water hardness level. . . . .	15
Filling the salt reservoir . . . . .	16
Salt indicator . . . . .	17
Rinse aid . . . . .	18
Adding rinse aid . . . . .	18
Rinse aid indicator . . . . .	19
Setting the rinse aid dosage . . . . .	20
<b>Loading the dishwasher</b> . . . . .	21
Upper basket . . . . .	22
Flap up rack . . . . .	22
Positioning rail. . . . .	22
Adjusting the upper basket . . . . .	23
Lower basket . . . . .	24
Bottle holder . . . . .	25
Cutlery . . . . .	26
Dishwashers with a cutlery basket . . . . .	26
Dishwashers with a cutlery tray (SC) . . . . .	28
Items not suitable for dishwashers: . . . . .	29

<b>Operating the dishwasher</b> . . . . .	30
Detergent . . . . .	30
Adding detergent . . . . .	31
Programme selection . . . . .	32
Switching on . . . . .	33
Starting a programme . . . . .	33
Programme sequence indicator lights . . . . .	33
At the end of a programme . . . . .	34
Switching off . . . . .	34
Interrupting a programme . . . . .	35
Changing a programme . . . . .	35
Drying heat . . . . .	36
Unloading the dishwasher . . . . .	37
<b>Cleaning and care</b> . . . . .	38
Cleaning the filters in the wash cabinet . . . . .	38
Cleaning the spray arms . . . . .	40
Cleaning the wash cabinet . . . . .	41
Cleaning the door and the door seal . . . . .	41
Cleaning the control panel and door front panel . . . . .	41
<b>Problem solving guide</b> . . . . .	43
<b>Solving problems</b> . . . . .	52
Cleaning the water inlet filter . . . . .	52
Cleaning the drain pump and non-return valve . . . . .	53
<b>After sales service</b> . . . . .	55
<b>Optional accessories</b> . . . . .	56
<b>Comparison tests</b> . . . . .	57
<b>Transport</b> . . . . .	59
<b>Programme chart</b> . . . . .	60
<b>Technical data</b> . . . . .	62

# Guide to the appliance

## Appliance overview

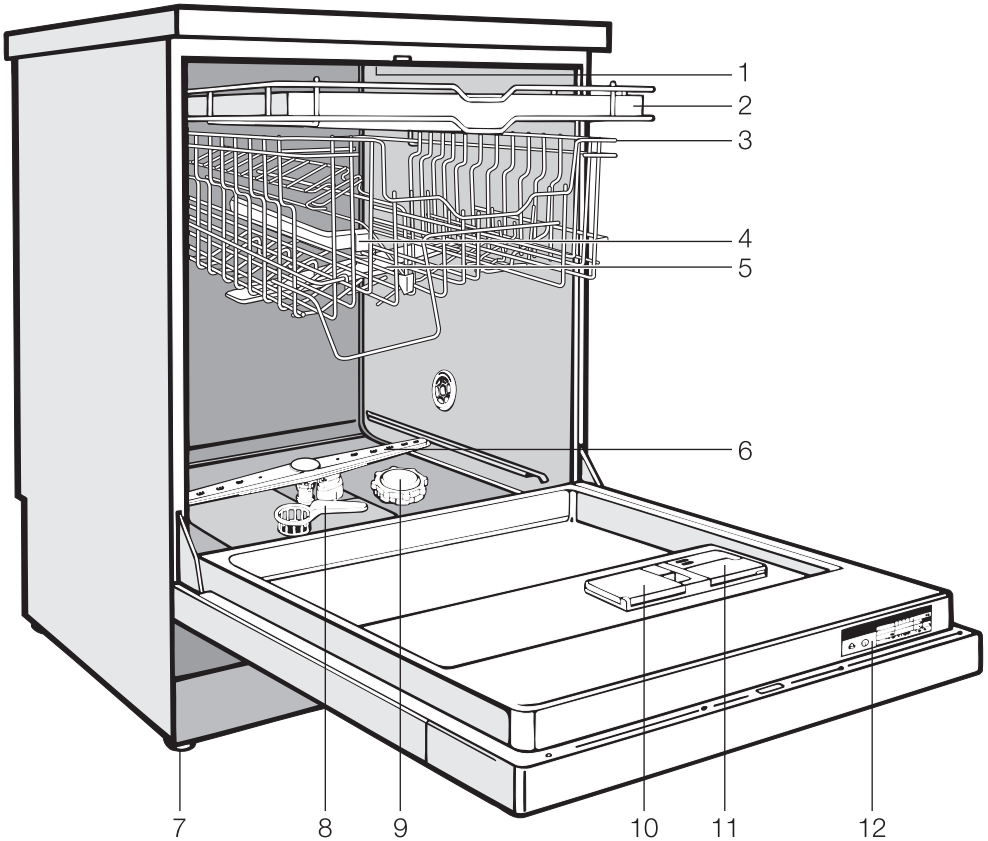

- |                                     |   |
|-------------------------------------|---|
| 1 Upper spray arm (not visible)     | 7 Four height adjustable screw feet           |
| 2 Cutlery tray (depending on model) | 8 Filter combination                          |
| 3 Upper basket                      | 9 Salt reservoir                              |
| 4 Water feed for middle spray arm   | 10 Dual compartment detergent dispenser       |
| 5 Middle spray arm                  | 11 Rinse aid reservoir (with dosage selector) |
| 6 Lower spray arm                   | 12 Data Plate                                 |

## Control panel

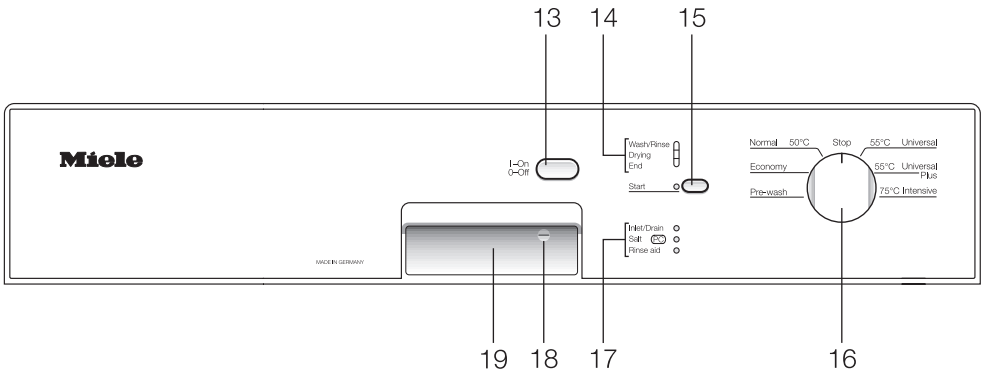

- |    |                            |    |                         |
|----|----------------------------|----|-------------------------|
| 13 | "On/Off" button            | 17 | Check/Refill indicators |
| 14 | Programme sequence display | 18 | Child safety lock       |
| 15 | "Start" button             | 19 | Door release            |
| 16 | Programme selector         |    |                         |

# Warning and Safety instructions

---

This appliance conforms to current safety requirements. Inappropriate use can however lead to personal injury and damage to property. Read the operating instructions carefully before starting to use this appliance. This way you will prevent the risk of accidents and damage to the appliance. Keep these instructions in a safe place for future reference, and pass them on to any future user.

## Correct usage

■ This dishwasher is intended exclusively for cleaning domestic crockery and cutlery in a domestic household. Using it for purposes other than those for which it was designed, as well as any alterations or conversions to the machine would be unauthorised and could cause harm. The manufacturer cannot be held liable for damage resulting from improper or incorrect use of the appliance.

## Delivery

- Before setting up the machine check it for any externally visible damage. Under no circumstances should you use a damaged machine. A damaged machine is dangerous.
- Please ensure that the packaging material is offered for recycling.

## Installation

- The dishwasher must be installed and connected in compliance with the installation instructions.
- The electrical socket must be easily accessible after the dishwasher has been installed.
- In order to ensure stability, built-under and integrated dishwashers must only be installed under a continuous worktop which is secured to adjacent cabinetry.
- The dishwasher must not be installed under a hob. The high radiant temperatures which are sometimes generated by a hob could damage the dishwasher.
- Do not connect the dishwasher to the mains supply until it has been installed.
- Check that the voltage, frequency and fuse rating shown on the data plate match the household mains supply.
- The electrical safety of this appliance can only be guaranteed when continuity is complete between the appliance and an effective earthing system. It is most important that this basic safety requirement is tested and where there is any doubt, the electrical system in the house is checked by a qualified electrician. The manufacturer cannot be held responsible for the consequences of an inadequate earthing system (e.g. electric shock).

# Warning and Safety instructions

---

■ This equipment is not designed for maritime use or for use in mobile installations such as caravans, aircraft etc. However it may be suitable for such usage subject to a risk assessment of the installation being carried out by a suitably qualified engineer.

■ A damaged machine is dangerous. Switch off at the mains and call your Miele supplier or the Miele Service Department.

■ The plastic housing of the water connection contains an electrical component. The housing must therefore not be dipped in water.

■ There are live wires in the water inlet hose. Never cut the water inlet hose, even if it is too long.

■ For safety reasons do not operate this appliance on an extension cable. (Danger of overheating).

## Daily use

■ Do not use solvents in the dishwasher. Danger of explosion.

■ Water in the dishwasher must not be used as drinking water. This water is not drinking water.

■ Avoid inhalation of powder detergents. Do not ingest dishwasher detergent! Dishwasher detergents contain irritant or corrosive ingredients. They can cause burning in the nose, mouth and throat if swallowed, or inhibit breathing. Consult a doctor immediately if detergent has been swallowed or inhaled.

■ Do not sit or lean on the opened door. This could cause the dishwasher to tip and be damaged and you could get injured.

■ In an appliance with a cutlery basket (depending on model) cutlery is cleaned and dried more efficiently if placed in the basket with the handles downwards. However, to avoid the risk of injury place cutlery with sharp points with the handles upwards.

■ Only use detergents formulated for domestic dishwashers. Do not use washing-up liquid.

■ Only use rinse aid formulated for domestic dishwashers.

■ Only use special coarse grained dishwasher salt for reactivation. Do not use other salts such as cooking salt, agricultural grade or gritting salt. These may contain insoluble additives which can impair the functioning of the water softener.

■ Plastic items which cannot withstand being washed in hot water, such as disposable plastic containers, or plastic cutlery and crockery should not be cleaned in the dishwasher. The high temperatures in the dishwasher may cause them to melt or lose shape.

# Warning and Safety instructions

---

## Take care on dishwashers with a visible heater element

(depending on model)

Do not touch the heating element during or directly after the end of a programme. It will be hot. Danger of burning!

Some plastic items could melt or catch fire if they were to come into contact with the heating element. Therefore always place plastic items or any other items which may not be completely heat resistant in the upper basket and ensure they cannot drop down onto the heater element.

Any items which are too small to be lodged securely in the upper basket should not be cleaned in the dishwasher.

## Safety with children

Do not allow children to play in or around the dishwasher, or to operate it. There is a danger that children playing might shut themselves in the dishwasher.

Keep children away from detergents. Dishwasher detergents contain irritant or corrosive ingredients. They can cause burning in the mouth, nose and throat if swallowed, or inhibit breathing. Consult a doctor immediately if your child has swallowed or inhaled detergent.

To avoid the danger of children coming into contact with the dishwasher detergent: only add detergent just before starting the programme and close the door, activating the child safety lock (depending on model). Keep children away from the dishwasher when the door is open. There could still be detergent residues in the cabinet.

To ensure children do not come into contact with detergent on models with the "Delay start" option make sure the dispenser is dry before adding detergent. Wipe dry if necessary. Detergent will clog if poured into a damp dispenser and may not be thoroughly dispersed. If the door is open at the end of a programme, children may come into contact with this residue.

## To avoid machine and material damage

Do not fill the rinse aid reservoir with powder or liquid detergent. This will cause serious damage to the reservoir.

Inadvertently filling the salt reservoir with powder or liquid dishwasher detergent always leads to serious damage to the water softener. Make sure you have picked up the correct packet of dishwasher salt before filling the salt reservoir!

Do not use commercial or industrial detergents as these may damage material and there is a risk of severe chemical reaction.



# Warning and Safety instructions

■ The Miele Waterproof System offers protection from water damage, provided the following conditions are met:

- The dishwasher is correctly installed and plumbed in.
- The dishwasher is properly maintained and parts are replaced where it can be seen that this is necessary.
- The stopcock has been turned off when the appliance is not used for a longer period of time (e.g. during holidays).

 In countries where there are areas which may be subject to infestation by cockroaches or other vermin, pay particular attention to keeping the appliance and its surroundings in a clean condition at all times. Any damage which may be caused by cockroaches or other vermin will not be covered by the appliance guarantee.

## Repairs and maintenance

■ Repairs may only be carried out by suitably qualified and competent engineers in accordance with local and national safety requirements. Repairs and other work by unqualified persons could be dangerous.

■ Always disconnect the appliance from the electrical supply for maintenance work (switch off at wall socket and remove the plug, or remove the screw out fuse in countries where this is applicable).

## Disposal of your old appliance

■ When disposing of an old dishwasher first make it unusable. Disconnect, cut off the cable and the plug from the cable. Make the door lock inoperative by unscrewing 2 cross-slotted screws, so that children cannot accidentally shut themselves in. Make appropriate arrangements for the disposal of the appliance.

The manufacturer cannot be held liable for damage caused by non-compliance with these Warning and Safety instructions.

# Caring for the environment

---

## Disposal of the packing material

The transport and protective packing has been selected from materials which are environmentally friendly for disposal and can normally be recycled.

Ensure that any plastic wrappings, bags etc. are disposed of safely and kept out of the reach of babies and young children. Danger of suffocation!

Rather than just throwing these materials away, please ensure that they are recycled.

## Disposal of your old appliance

Old appliances contain materials which can be recycled. Please contact your dealer, your local waste collection centre or scrap merchant about potential recycling schemes.

Ensure that the appliance presents no danger to children while being stored for disposal. See the appropriate section in the Warning and Safety instructions.

## Energy saving washing

This dishwasher is exceptionally economical in its use of water and electricity. You can make the most of your appliance by following these tips:

- If your household water system is suitable, this dishwasher can be connected to a hot water supply, for further economies.

Although all stages of the wash then take place with hot water, savings are made in:

- the use of primary energy,
- costs,
- programme running times.

If, however, your water is heated by electricity we would still recommend connection to cold water.

- For most economical dishwashing make full use of the baskets without overloading the dishwasher.
- Choose the programme to suit the type of crockery being washed and the degree of soiling.
- Select the Economy programme for energy-saving dishwashing.
- Use the correct amounts of detergent.
- Use only 2/3 of the given dosage if baskets are only half full.
- The drying heat can be switched off, shortening the length of the programme and saving energy. The load then dries to a large extent in its own heat (see "Drying heat")

### **Before using the appliance for the first time you require:**

- approx. 2 litres of water,
- approx. 2 kg dishwasher reactivation salt,
- domestic dishwasher detergent,
- rinse aid formulated for domestic dishwashers.

Every dishwasher is tested at the factory. There will be residual water in the appliance from this test. It is not an indication that it has been previously used.

## Before using for the first time

### To open the door

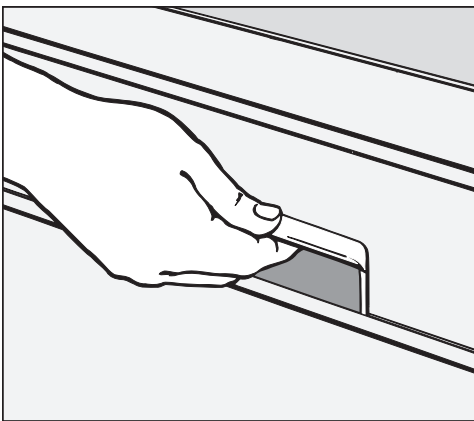

- Press the release catch inside the door grip and pull forward.

If the door is opened during operation all functions are automatically interrupted.

### To close the door

- Push the baskets right in, lift the door and push until it clicks into position.

### Child safety lock

The yellow key for the child safety lock is on one of the spikes at the front of the upper basket. Remove the key before switching on the dishwasher and keep it in a safe place away from the dishwasher.

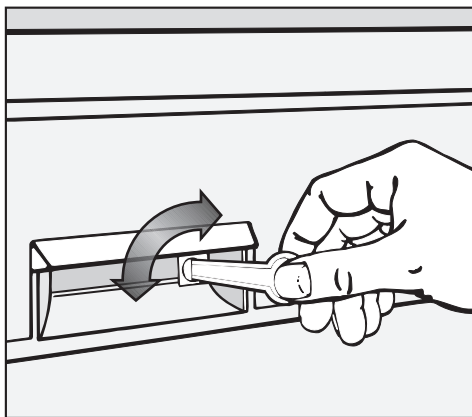

To prevent children opening the dishwasher door during operation, use the key to lock the door:



Horizontal setting:  
The door is locked.



Vertical setting:  
The door can be opened.

## Before using for the first time

---

### Water softener

In order to achieve good cleaning results, the dishwasher needs to operate with soft water. Hard water results in the build-up of calcium deposits on crockery and in the dishwasher.

Mains water with a hardness level higher than 0.7 mmol/l (4° d - German scale) needs to be softened. This takes place automatically in the integrated water softener.

- The water softener must be filled with dishwasher salt for reactivation.
- The dishwasher must be programmed to correspond to the water hardness in your area.
- Your local water authority will be able to advise you of the water hardness level in your area.

Where the water hardness fluctuates e.g. between 1.4 - 3.1 mmol/l (8 - 17 °d German scale) always programme the dishwasher to the higher value (3.1 mmol/l in this example).

In the event of a fault, it will help the service technician if you know the hardness of your local water supply.

- Enter the water hardness below:

\_\_\_\_\_ mmol/l or °d

# Before using for the first time

## Programming the water hardness level

- Switch the dishwasher off using the "On/Off" button.
- Turn the programme selector to the "Stop" position.
- Press the "Start" button in and whilst holding it in switch the dishwasher on using the "On/Off" button. Release the "Start" button within two seconds.

The "Salt" indicator light will flash.

### Warning:

If a different indicator light comes on or flashes, the process must be repeated.

### Exception:

The "Rinse aid" indicator light will come on if you have not yet added rinse aid or if rinse aid needs replenishing.

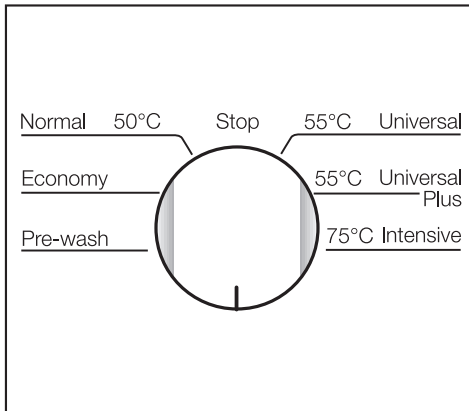

- Turn the programme selector to the position that corresponds to your water hardness level (see chart below).

°d German scale	mmol/l	Programme selector setting
1 - 4	0.2 - 0.7	"1 o'clock" position
5 - 7	0.9 - 1.3	"2 o'clock" position
8 - 10	1.4 - 1.8	"3 o'clock" position
11 - 13	2.0 - 2.3	"4 o'clock" position
<b>14 - 16</b>	<b>2.5 - 2.9</b>	<b>"5 o'clock" position</b>
17 - 22	3.1 - 4.0	"6 o'clock" position
23 - 35	4.1 - 6.3	"7 o'clock" position
36 - 70	6.5 - 12.6	"8 o'clock" position

The dishwasher is set at the factory for a hardness level of 2.5 -2.9 mmol/l (14 -16 °d ).

### Example:

For a water hardness of 3.5 mmol/l, turn the programme selector to the "6 o'clock" position.

## Before using for the first time

---

- Press the "Start" button.

The "Start" indicator light will come on.

- Turn the programme selector to the "Stop" position.
- Switch the dishwasher off using the "On/Off" button.

The water hardness level is now stored in memory.

### Checking the programmed water hardness level

- Switch the dishwasher off using the "On/Off" button.
- Turn the programme selector to the "Stop" position.
- Press the "Start" button in and whilst holding it in switch the dishwasher on using the "On/Off" button. Release the "Start" button within two seconds.

The "Salt" indicator light will flash.

### Warning:

If a different indicator light comes on or flashes, the process must be repeated.

### Exception:

The "Rinse aid" indicator light will come on if you have not yet added rinse aid or if rinse aid needs replenishing.

- Click the programme selector from the "1 o'clock" position as far as the "8 o'clock" position.

When the programme selector is at the position which corresponds to the water hardness setting already programmed, the "Start" indicator light will come on (see chart "Programming and setting the water hardness level").

- Turn the programme selector to the "Stop" position.
- Switch the dishwasher off using the "On/Off" button.

## Before using for the first time

### Filling the salt reservoir

If the water in your area is very soft and constantly lower than 0.7 mmol/l (4 °d) you do not need to add dishwasher salt.

The water softener must, however, still be programmed to correspond to the water hardness level in your area. (The salt indicator light will still come on, but should be ignored).

**Important:** Before filling the salt reservoir with dishwasher salt for the first time, you must fill it with approx. 2 litres of water to enable the salt to dissolve. Once the dishwasher has been used, there is always sufficient water in the reservoir.

**⚠** Inadvertently filling the salt reservoir with powder or liquid dishwasher detergent always leads to serious damage to the water softener. Make sure you have picked up the correct packet of dishwasher salt before filling the salt reservoir!

**⚠** Only use special coarse grained dishwasher salt for reactivation. Do not use other salts such as cooking salt, agricultural grade or gritting salt. These may contain insoluble additives which can impair the functioning of the water softener.

- Remove the lower basket and unscrew the salt reservoir cap.
- Fill the reservoir with approx. 2 litres of water (first use).



- Place the funnel provided over the salt reservoir and carefully fill with salt until the reservoir is full. The salt reservoir holds approx. 2 kg of salt depending on the brand used.

As the salt reservoir is filled, displaced water will overflow.

- Clean any excess salt from around the reservoir opening and then screw the cap on again firmly.
- Run the "Pre-wash" programme immediately to remove any traces of salt water from the cabinet.



### Salt indicator

The salt indicator light comes on to notify you that the reservoir is empty.

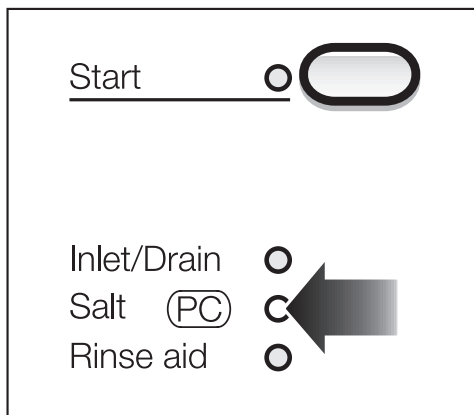

- The reservoir should then be refilled with dishwasher salt for reactivation. (See: Filling the salt reservoir).

After the reservoir has been filled, the water softener is automatically reactivated the next time the dishwasher is run. The salt indicator light may still be illuminated during this process. It will go out once the salt concentration has reached the correct level.

### Note

If the water in your area is very soft and constantly lower than 0.7 mmol (4 °d) you do not need to add salt to the reservoir. The salt indicator light, however, will still come on, but should be ignored.

(See "After sales service" for definition of "PC").

## Before using for the first time

### Rinse aid

Rinse aid is necessary to ensure water does not cling and leave marks on crockery during the drying phase. Rinse aid is poured into the storage reservoir and the amount set is dispensed automatically.

 Inadvertently filling the rinse aid reservoir with powder or liquid dishwasher detergent always causes serious damage to the reservoir. Only pour rinse aid formulated for domestic dishwashers into the reservoir.

Alternatively, it is possible to use

- Household vinegar with a max. 5% acid content

or

- Liquid citric acid up to 50% acid content.

The resulting rinsing and drying quality will not, however, be as good as when rinse aid is used.

 Do not use vinegar with a higher acid content (e.g. vinegar essence 25% acid). This must not be used as its use would damage the dishwasher.

### Adding rinse aid

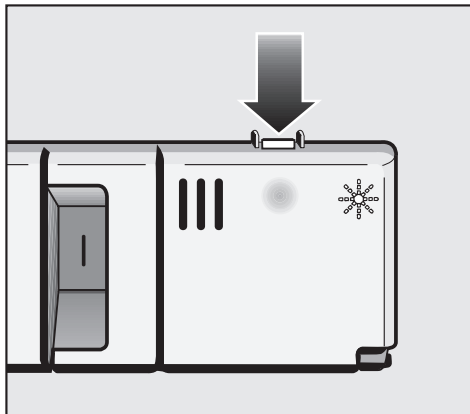

- Press the button in the direction of the arrow until the flap springs open.

## Before using for the first time

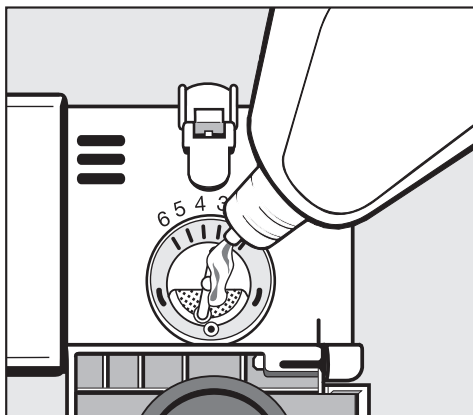

- Add rinse aid only until it is visible on the surface of the filter in the opening.

The rinse aid reservoir holds approx. 130 ml.

- Close the flap firmly so that it clicks into place. Otherwise water would enter the rinse aid reservoir during a programme.
- Wipe up any spilled rinse aid. This prevents over-foaming occurring during the next programme.

### Rinse aid indicator

The Rinse aid indicator light on the fascia comes on when the rinse aid reservoir needs to be replenished.

Start

Inlet/Drain

Salt  (PC)

Rinse aid  C

When the light comes on the reservoir still contains sufficient rinse aid for 2 - 3 programmes.

- Add rinse aid in plenty of time.

## Before using for the first time

---

### Setting the rinse aid dosage

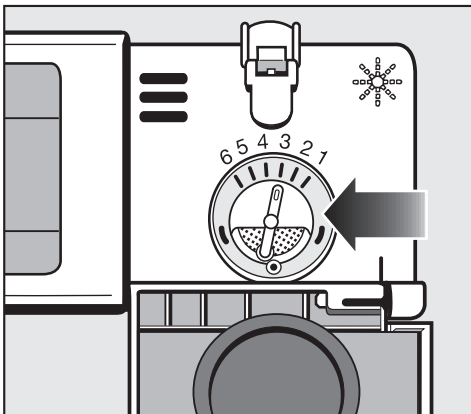

The dosage selector has settings from 1-6. It is set to "3" (3 ml) at the factory. Approx. 3 ml of rinse aid are then used per programme. This is a recommended setting.

If spots appear on crockery and glassware:

- Use a higher setting.

If clouding or smearing appears on crockery and glassware:

- Use a lower setting.

# Loading the dishwasher

## Note

- Remove coarse food residues from crockery.

There is no need to rinse items under running water.

 Do not wash items soiled with ash, sand, wax, lubricating grease or paint in the dishwasher. Ash does not dissolve and is distributed in the wash cabinet. Wax, sand, lubricating grease and paint cause damage to the dishwasher.

Crockery can be loaded anywhere in the baskets, but the following notes should be observed:

- Do not place crockery and cutlery inside other pieces where they may be concealed.
- Load the crockery so that water can access all surfaces. This ensures that it is properly cleaned.
- Make sure that all items are securely positioned.
- Hollow items such as cups, glasses, pans, etc. must be inverted in the basket.
- Tall, narrow, hollow items, e.g. champagne glasses, should be placed in the centre of the basket to ensure better water coverage.

- Deep based items should be placed at an angle so that water can run off them freely.
- The spray arms must not be blocked by items which are too tall or hang through the baskets.  
If in doubt, test for free movement by manually rotating the spray arms.
- Make sure that small items do not fall through the holders in the baskets. Small items, e.g. lids, should therefore be placed in the cutlery tray or cutlery basket.

Some foodstuffs may contain natural dyes, e.g. carrots, tomatoes or ketchup. Plastic items in the dishwasher may discolour if large quantities of these foodstuffs find their way into the appliance on the crockery. The stability of plastic items is not affected by this discolouration.

When the dishwasher is being loaded food and drink residue may drip onto the sides of the dishwasher door. These surfaces are outside the wash cabinet and are not accessed by water from the spray arms. Food residue should therefore be wiped away before the dishwasher door is closed.

# Loading the dishwasher

## Upper basket

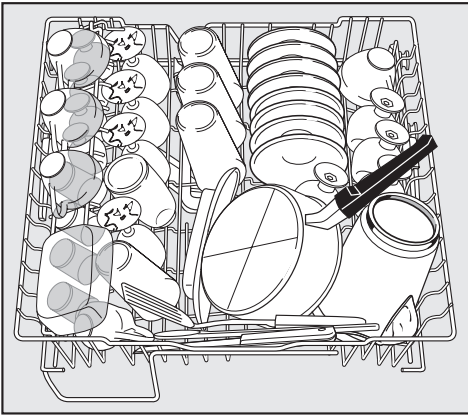

For small, lightweight, delicate items such as cups, saucers, glasses, dessert bowls, etc. as well as plastic items which are heat resistant. Shallow saucepans or casserole dishes can also be placed in the upper basket.

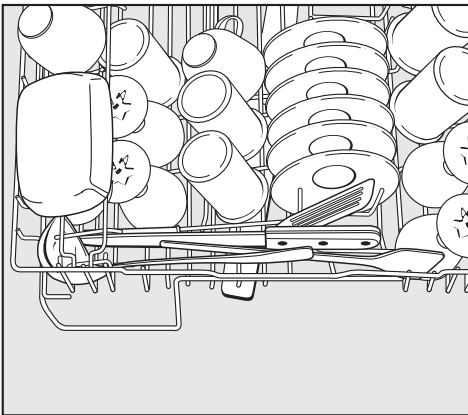

Long items such as soup ladles, mixing spoons and long knives should be placed lying down across the front of the upper basket.

## Flap up rack

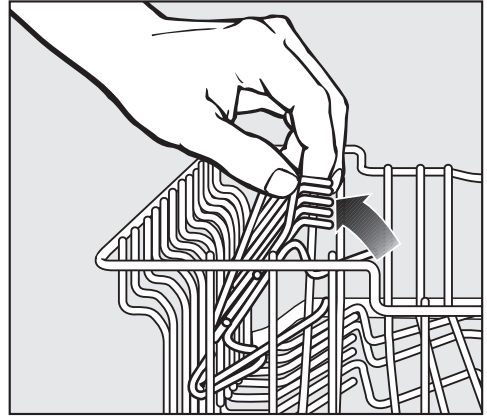

To make room for tall items raise the rack upwards.

## Positioning rail

(depending on model)

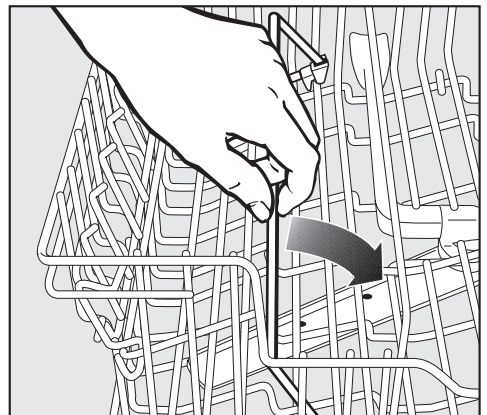

The positioning rail can be flipped over to the middle of the basket for easy sorting and removing of crockery.

# Loading the dishwasher

## Adjusting the upper basket

(depending on model)

In order to gain more space for taller pieces of crockery in the bottom or upper basket, the upper basket can be adjusted on three levels with 2 cm between each level.

The upper basket can also be set at an angle with one side high and the other side low. Ensure however, that the basket can be inserted smoothly into the cabinet.

It is best to adjust the basket before loading it.

- Pull out the upper basket.

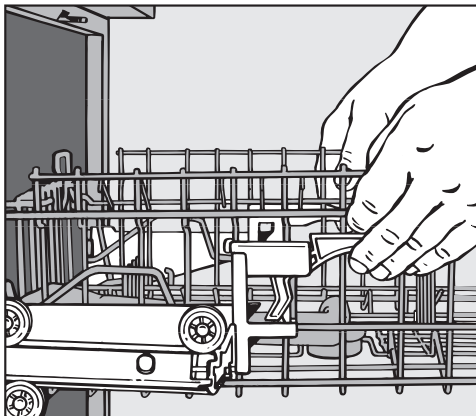

- Pull upwards on the levers at either side of the upper basket.
- Adjust the basket to the desired height.
- Then push the levers securely back down into position.

Depending on the setting of the upper basket, the following plate dimensions can be accommodated.

## Dishwashers with cutlery tray

Upper basket level	Plate Ø in cm	
	Upper basket	Lower basket
Top	15	30
Middle	17	28
Bottom	19	26

## Dishwashers with cutlery basket

without adjustment to upper basket

Plate Ø in upper basket: 23 cm

Plate Ø in lower basket: 28 cm

# Loading the dishwasher

## Lower basket

For larger and heavier items such as plates, serving platters, saucepans, bowls, etc.

Small items such as saucers can also be placed in the lower basket.

Do not place thin, delicate glassware in the lower basket. Delicate glassware can only be washed in the bottom of the dishwasher in a special lower basket with a glassware insert.

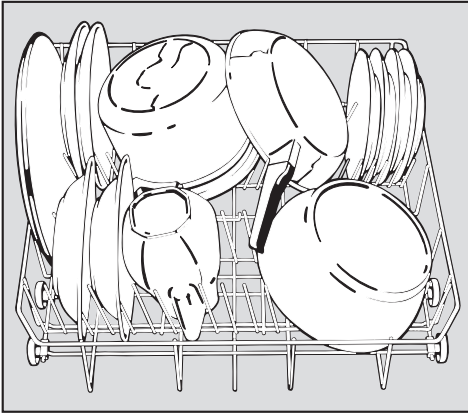

## Height limitation

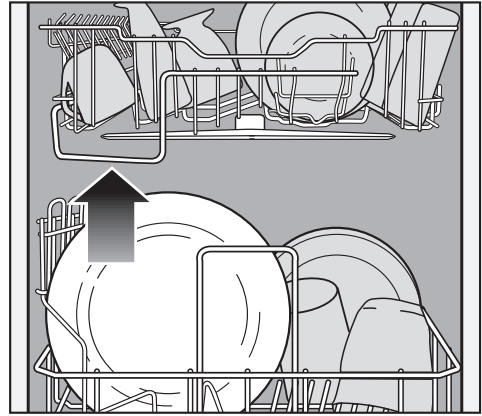

The stay at the front of the upper basket determines the max. height permissible for items placed in the lower basket to ensure they do not impede the movement of the middle spray arm.

## Dishwashers with cutlery tray

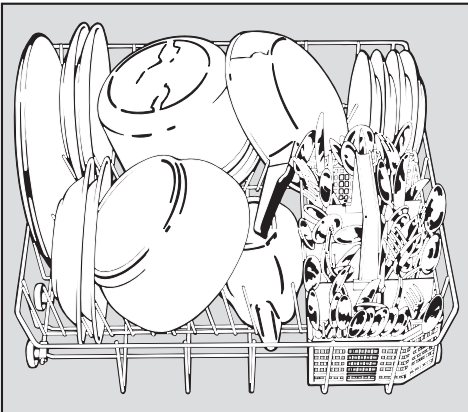

## Dishwashers with cutlery basket



## Bottle holder

(depending on model)

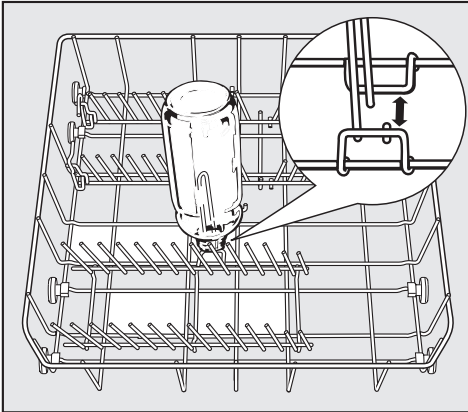

The bottle holder, e.g. for milk and baby bottles, can be fitted in the lower basket in the area marked white in the illustration. However, do not place a bottle holder in the corners. Water will not be able to access the bottles properly, and cleaning results will be impaired.

# Loading the dishwasher

## Cutlery

### Dishwashers with a cutlery basket



⚠ However, to avoid the risk of injury cutlery with sharp points should be placed with the handles up-wards.

Place small spoons in the individual slots to either side of the cutlery basket.

- Unsorted cutlery should be placed in the cutlery basket with the handles facing downwards to ensure optimum spray water access.

### Spoon inserts for the cutlery basket

Use the inserts supplied when washing heavily soiled spoons, e.g. tablespoons and serving spoons.

The inserts separate the spoons to allow a space between them so that they can be more easily accessed by water.

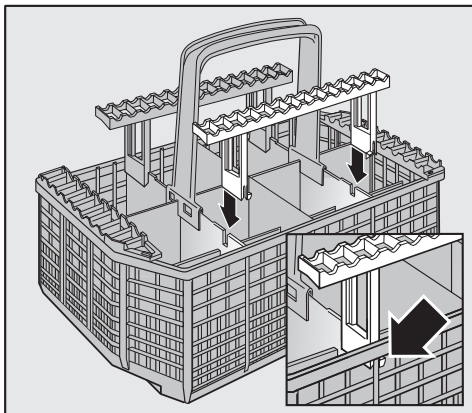

- If required, place an insert onto the front and rear of the cutlery basket.

To remove the inserts:

- Press the engaged hooks inwards (use a spoon handle if necessary) and remove the insert by pulling it upwards.

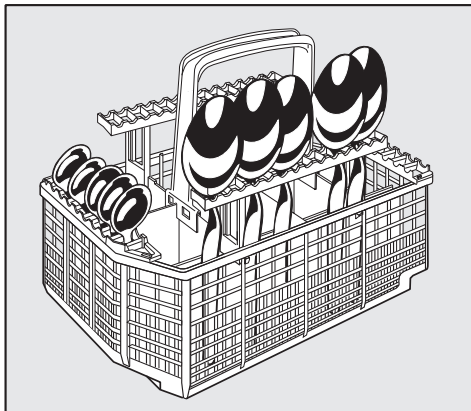

- Insert the spoons with the handles facing downwards, using only every other slot.

# Loading the dishwasher

## Dishwashers with a cutlery tray (SC)

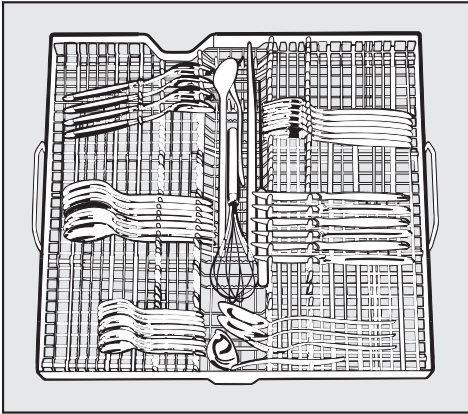

For best results cutlery should be grouped in zones, one for knives, one for forks, one for spoons, etc. This makes unloading much easier.

Place the blades of knives and the prongs of forks between the holders. Spoons, on the other hand, should be placed with the handles between the holders.

Longer items such as soup ladles, cake slices, mixing spoons and long knives should be placed lengthwise in the indentation in the middle of the cutlery tray.

The upper spray arm must not be blocked by items which are too big (e.g. cake slices).

The cutlery tray insert is removable.

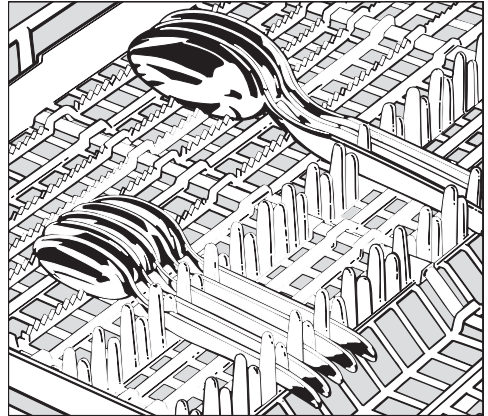

Spoon heads should be placed in contact with at least one of the serrated retainers on the base of the cutlery tray to ensure that water runs off them freely.

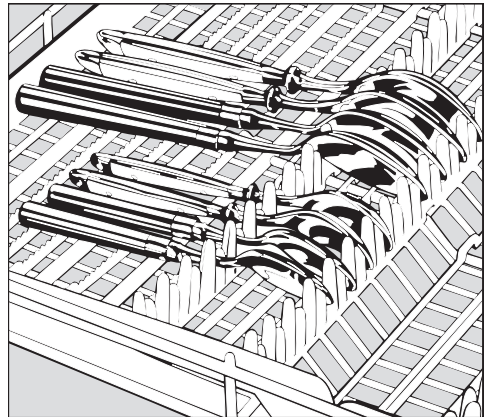

If spoon handles do not fit between the holders then lay them the other way round making sure that the head of the spoon is in contact with the support on the bottom of the tray.

## Items not suitable for dishwashers:

- Wooden cutlery and crockery or items with wooden parts: these may discolour and fade. The glue used in these items is not dishwasher-proof and wooden handles may come loose after being washed in a dishwasher.
- Craft items, antiques, valuable vases and decorative glassware are also not suitable for dishwashers.
- Plastic items which are not heat resistant. The high temperatures in the dishwasher may cause them to melt or lose shape.
- Copper, brass, tin and aluminium items may discolour or become matt.
- Colours painted over a glaze may fade after a number of washes.
- Clouding may occur on glasses after frequent washing. Do not wash glassware containing lead crystal in a dishwasher.

## We recommend:

- When purchasing new crockery and cutlery, make sure they are dishwasher-proof.
- There are no standard guidelines for washing glassware. When in doubt, wash glassware by hand.
- If delicate glassware is washed in the dishwasher ensure that only very low temperatures are used (see programme chart). This will reduce the risk of clouding.

## Please note

Silverware previously cleaned with a silver polish may still be damp or spotted at the end of a programme, where water has not run off smoothly. It may need rubbing dry with a soft cloth. Silver treated in a silver immersion dip is usually dry at the end of a programme but may discolour.

Silver which has been in contact with foods containing sulphur can discolour. These include egg yolk, onions, mayonnaise, mustard, pulses, fish, fish brine and marinades.

 Aluminium components (e.g. a grease filter) must not be cleaned with caustic alkaline commercial or industrial cleaning agents. These may damage material, or in extreme cases, cause severe chemical reaction. See section "Adding detergent" for information on suitable detergents.

# Operating the dishwasher

## Detergent

 Only use detergents formulated for domestic dishwashers. Do not use washing up liquid.

- You can use conventional powder detergent, tablets or liquid dishwasher detergent.  
Refer to the dosing instructions given by the manufacturer on the packaging.
- Put powder or liquid detergent into the dispenser compartment.
- Detergent tablets should only be put into compartment II if this is recommended by the manufacturer.  
If the manufacturer recommends inserting tablets in the cutlery basket do not do so. Instead place them on the inside of the door or directly into the wash cabinet to help them dissolve properly.

Detergent manufacturers give the required amount of detergent for a particular programme on their packaging.

- Use at least 30 ml of detergent for a full load in the following programmes:
  - Intensive,
  - Universal plus,
  - Universal,
  - Normal,
  - Economy.If the manufacturer recommends a larger amount of detergent, use the amount recommended.

Failure to dispense the recommended amount of detergent may impair cleaning results.

If you are using 2 in 1 or 3 in 1 combination tablets, please continue to replenish the salt and rinse aid reservoirs as described in this booklet. Otherwise the cleaning and drying performance of the machine may deteriorate over time.

## Adding detergent

 Avoid inhalation of powder detergents and do not ingest dishwasher detergent! Dishwasher detergents contain irritant or corrosive ingredients. They can cause burning in the nose, mouth and throat if swallowed, or inhibit breathing. Consult a doctor immediately if detergent has been swallowed or inhaled. Keep children away from detergents and from the dishwasher when the door is open. There could still be detergent residues in the cabinet. To avoid the danger of children coming into contact with the dishwasher detergent only add detergent just before starting the programme and close the door, activating the child safety lock.

It is essential to follow the instructions given in the programme chart at the end of the operating instructions.

### For information

Compartment I holds max. 20 ml,  
Compartment II holds max. 70 ml.

There are markings in compartment II to assist with dispensing. The marks indicate a level of approx. 20, 25, 30 ml when the door is open in a horizontal position.

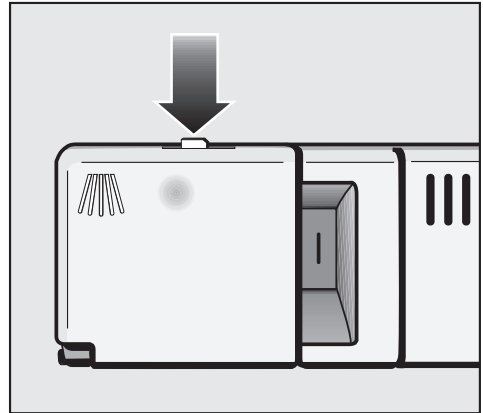

- Press the opening catch on the detergent dispenser. The flap will spring open.

The flap is always open at the end of a programme.

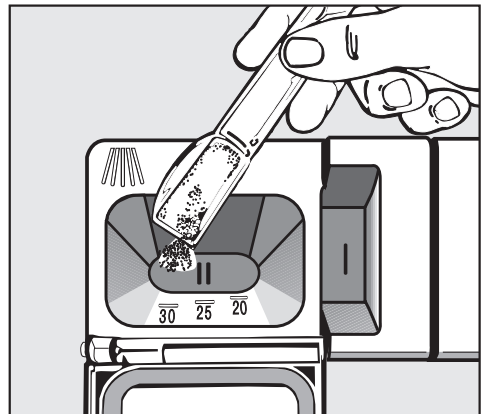

- Add the required amount of detergent and close the flap.
- Ensure that the detergent package is properly sealed after use. Otherwise the detergent can lose its effectiveness.

# Operating the dishwasher

---

## Programme selection

Choose your programme according to the type of load and how dirty it is.

In most cases this will be a Universal programme or a Universal plus programme.

These programmes are ideally suited to everyday mixed loads with varying degrees of soiling.

The different programmes and their uses are described in the programme chart at the end of this booklet.



# Operating the dishwasher

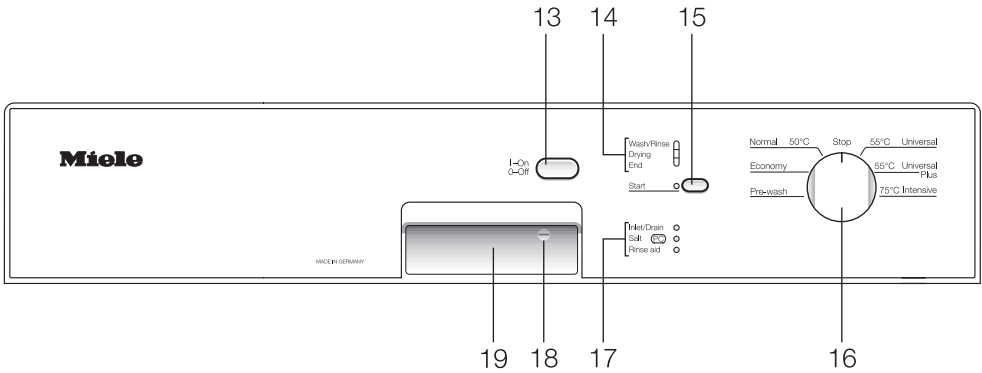

## Switching on

- Make sure the spray arms are not obstructed.
- Close the door.
- Open the stopcock, if it is closed.
- Press the "On/Off" button (13).

The "Start" indicator light (15) will flash.

## Starting a programme

- When selecting a programme, refer to the programme chart at the end of the operating instructions.
- Turn the programme selector (16) clockwise or anti-clockwise to the required programme.
- Press the "Start" button (15).

The programme cycle begins. The "Start" (15) and "Wash/Rinse" (14) indicator lights come on.

Do not finish a programme prematurely. Important programme stages (e. g. reactivating the water softener) could be omitted.

## Programme sequence indicator lights (14)

The "Wash/Rinse" indicator light comes on in the pre-wash, main wash, interim rinse and final rinse stages of a programme.

The "Drying" indicator light comes on during the drying stage of a programme.

The "End" indicator light comes on when the programme has finished.

# Operating the dishwasher

---

## At the end of a programme

A programme has finished when the "End" indicator light comes on in the programme sequence display (14).

The dishwasher can now be opened and unloaded (see "Unloading the dishwasher").

 Do not touch the heating element during or directly after the end of a programme. Danger of burning.

For safety's sake it is advisable to always switch the dishwasher off if you do not wish to start another programme immediately.

## Switching off

At the end of a programme:

- Turn the programme selector (16) to the "Stop" position.

The "End" indicator light (14) goes out and the "Start" indicator light (15) flashes.

- Press the "On/Off" button (13).

The "Start" indicator light (15) goes out.

The dishwasher continues to use electricity until switched off using the "On/Off" button.

If the dishwasher is not to be used for a longer period of time, e. g. whilst on holiday, the stopcock should be turned off.

## Interrupting a programme

A programme is interrupted as soon as the door is opened.

If the door is closed again, the programme will continue from the point it was at before the door was opened.

 Water in the dishwasher may be hot. Danger of scalding!  
Only open the door if absolutely necessary and exercise extreme caution when doing so. Before closing the door again, leave it ajar for approx. 20 secs. This will enable the temperature in the wash cabinet to settle. Close the door firmly making sure that it clicks into place.

 Do not touch the heating element during a programme interruption. Danger of burning.

## Changing a programme

Important:

If the detergent dispenser flap has already opened, do not change the programme.

If a programme has already started and you wish to change it proceed as follows:

- Turn the programme selector (16) to the "Stop" position.
- Leave the programme selector (16) in this position for at least one second.
- Then turn the programme selector (16) to the programme you wish to use.
- Press the "Start" button (15).

The programme cycle begins.

# Operating the dishwasher

---

## Drying heat

In all programmes the drying process is assisted by the heating element. Drying heat is set as activated at the factory.

Switching the heating elements off during drying will save approx. 0.1 kWh in electricity. The dishes are then dried with residual heat. Open the dishwasher door at the end of a programme to allow the dishes to dry better.

## Activation/Deactivation of drying heat

- Switch the dishwasher off using the "On/Off" button.
- Turn the programme selector to the "Stop" position.
- Press the "Start" button in and whilst holding it in switch the dishwasher on using the "On/Off" button. Release the "Start" button within two seconds.

The "Salt" indicator light will start flashing

### Note:

If a different indicator light comes on or flashes, the process must be repeated.

### Exception:

The "Rinse aid" indicator light will come on if you have not yet added rinse aid or if rinse aid needs replenishing.

- Turn the programme selector to the "10 o'clock" position.
  - If the "Start" indicator light does not come on:  
Drying heat is switched on.
  - If the "Start" indicator light does come on:  
Drying heat is switched off.
- Press the "Start" button to change the setting.

Depending on the previous setting the "Start" indicator light will either come on or go out.

- Turn the programme selector to the "Stop" position.
- Switch the dishwasher off using the "On/Off" button.

The change is now stored in memory.

## Unloading the dishwasher

- Dishes tend to break and chip more easily when they are hot. Allow the dishes to cool until they are comfortable enough to handle before unloading them.
- If you open the door fully after switching off, the dishes will cool much faster.
- First unload the lower basket, then the upper basket and finally the cutlery tray (depending on model). This will prevent water drops from the upper basket and cutlery tray from falling onto the dishes in the lower basket.

## Cleaning and care

Check your dishwasher regularly (approx. every 4 - 6 months). This way faults and problems can be avoided.

### Cleaning the filters in the wash cabinet

The filter combination in the base of the wash cabinet retains coarse soil from the suds solution, preventing it accessing the circulation system and re-entering the cabinet through the spray arms.

 The dishwasher must not be used without all the filters in place.

Collection of coarse soil may cause the filters to clog.

Check the filter combination regularly (every 4 - 6 months) and clean if necessary.

- Switch the dishwasher off beforehand.

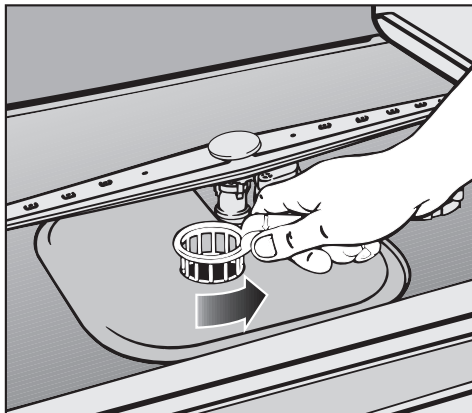

- Turn the handle anti-clockwise to release the filter combination.

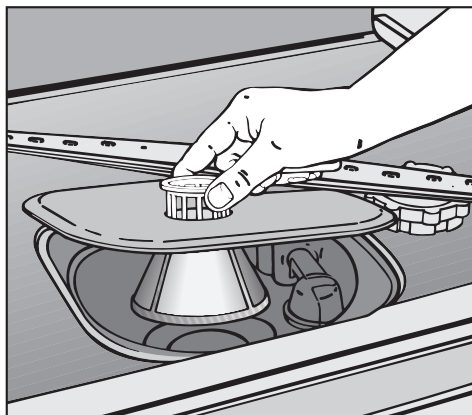

- Lift the filter combination out of the dishwasher. Remove any coarse particles and rinse the filter under running water. Use a nylon brush if necessary.

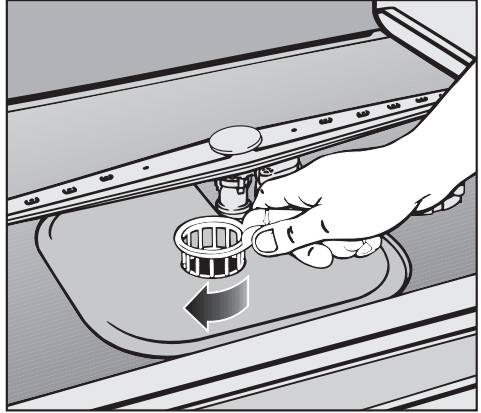
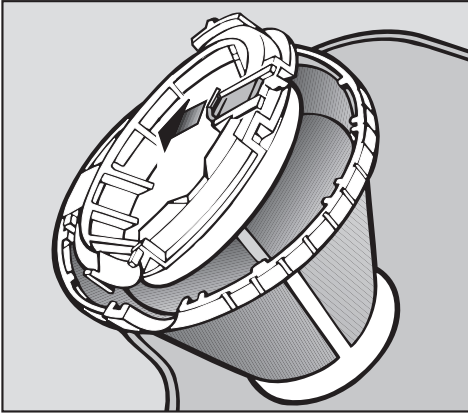

To clean the underside of the filter, the flap must be opened:

- Pull back the yellow clip to do this.
- Rinse all parts under running water, using a nylon brush if necessary.
- Then close the flap so that the clip engages. Important: After cleaning make sure that the clip has properly engaged.

- Replace the filter combination so that it lies flat in the base of the wash cabinet.
- Secure the filter by turning the handle in a clockwise direction.

 Take care when you are fitting the filter combination that it is secured in position correctly. Otherwise coarse soil could get into the circulation system and cause a blockage.

# Cleaning and care

## Cleaning the spray arms

Particles of food can get stuck in the spray arm jets and bearings. The spray arms should therefore be inspected and cleaned regularly (approx. every 4 - 6 months).

- Switch the dishwasher off beforehand.

Remove the spray arms as follows:

- Take out the cutlery tray (if your dishwasher is fitted with one).
- Press the top spray arm upwards to engage the inner ratchet. Then unscrew the spray arm.

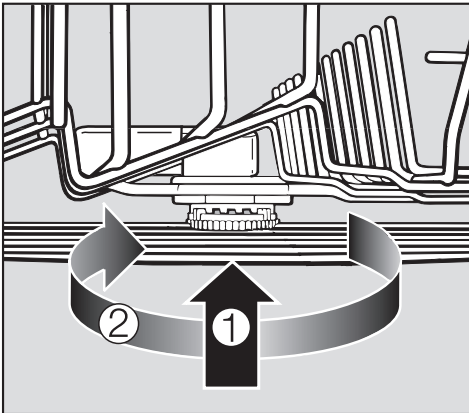

- Lift up the middle spray arm to engage the ratchet. Then unscrew the spray arm ②.

- Remove the lower basket.

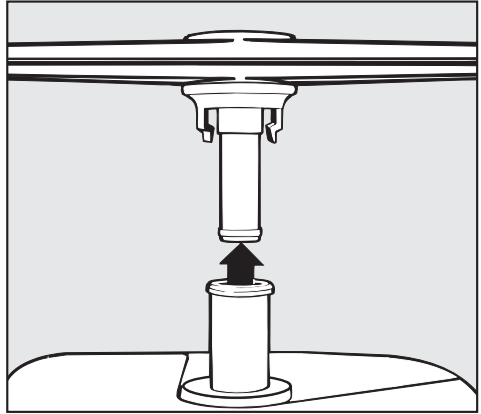

- Pull the lower spray arm firmly upwards to remove it.

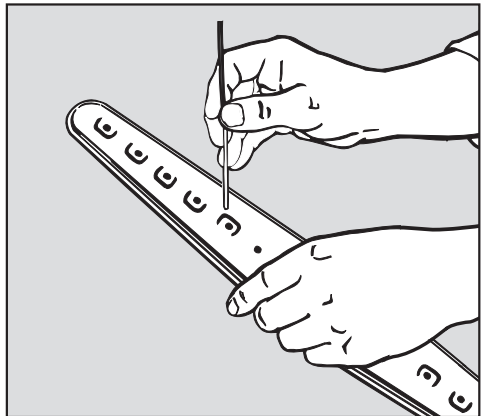

- Use a pointed object to push food particles into the spray arm jets.
- Rinse thoroughly under running water.
- Replace the spray arms and check that they rotate freely.



## Cleaning the wash cabinet

The wash cabinet is largely self-cleaning, provided that the correct amount of detergent is always used.

If, however, there are limescale or grease deposits in the cabinet these can be removed with a proprietary dishwasher cleaner.

## Cleaning the door and the door seal

- Wipe the door seals regularly with a damp cloth to remove food deposits.
- When the dishwasher is being loaded food and drink residue may drip onto the sides of the dishwasher door. These surfaces are outside the wash cabinet and are not accessed by water from the spray arms. Any soiling should be wiped off these surfaces before the door is closed.

## Cleaning the control panel and door front panel

### Plastic panels:

- This type of panel should only be wiped with a damp cloth or suitable cleaning agent designed for use on plastic.

 Do not use abrasive cleaning agents, glass cleaning agents or all-purpose cleaners. Because of their chemical composition they could cause serious damage to plastic surfaces.

### Stainless steel panels:

- Clean using a proprietary non-abrasive cleaning agent designed specifically for use on stainless steel. To help prevent re-soiling, proprietary conditioning agents for stainless steel can also be used. Apply sparingly with an even pressure in the direction of the grain.

### Aluminium panels:

Aluminium is affected by the way that light falls on it, by the surrounding environment and by the angle you observe it from.

Aluminium is susceptible to scratching and abrasion and must be treated with due care.

- Soiling should be removed as soon as possible using a damp cloth and a little washing up liquid.

 Aluminium surfaces and controls may suffer discolouration or damage if soiling is left on them for too long.

## Cleaning and care

---

### Wood door front panels:

- Door fronts made from wood should only be cleaned using a damp cham-  
ois leather and then dried with a soft  
cloth.

 Do not use any cleaning agents  
containing ammonia or thinners.  
These would damage the surface  
structure.

### **E-Cloth:**

A microfibre "E-Cloth" is available from  
the Miele UK Spare Parts Department,  
Part number 98013530, which is suit-  
able for cleaning surfaces such as  
stainless steel, glass, plastic and  
chrome without the use of chemicals.

## Problem solving guide

With the aid of the following guide, minor problems can be easily corrected without calling in a Miele service technician, saving you both time and money.

You should, however, note the following:

 Repairs should only be carried out by a suitably qualified and trained person in accordance with local and national safety regulations. Unauthorised or incorrect repairs could cause personal injury or damage the appliance.

<b>Problem</b>	<b>Possible cause</b>	<b>Remedy</b>
<b>The "Start" indicator light does not flash after the appliance has been switched on with the "On/Off" button.</b>	The door is not properly closed.	Close the door firmly.
	The appliance is not plugged in.	Insert the plug.
	The fuse is defective or has tripped.	Replace the fuse (see data plate for minimum fuse rating).
<b>The dishwasher does not start after the "Start" button has been pressed; the "Start" indicator light is flashing.</b>	The programme selector is at the "Stop" position.	<ul style="list-style-type: none"><li>– Turn the programme selector to the required programme.</li><li>– Press the "Start" button.</li></ul>
<b>The dishwasher stops during a programme.</b>	The fuse is defective or has tripped.	Replace the fuse (see data plate for minimum fuse rating).

## Problem solving guide

<b>Problem</b>	<b>Possible cause</b>	<b>Remedy</b>
<b>The indicator light "Inlet/Drain" lights up and flashes alternately</b>	The stopcock is closed.	Open the stopcock fully.
	The water inlet filter is blocked.	Before rectifying the problem you must: <ul style="list-style-type: none"><li>– Turn the programme selector to the "Stop" position.</li><li>– Switch the dishwasher off using the "On/Off" button.</li></ul> then: <ul style="list-style-type: none"><li>– Clean the water inlet filter, see "Solving problems".</li></ul>
	The Waterproof system has reacted.	Call the Miele Service Department.

## Problem solving guide

Problem	Possible cause	Remedy
<b>The indicator light "Inlet/Drain" is flashing and the programme does not continue.</b>		Before rectifying the problem you must: <ul style="list-style-type: none"><li>– Turn the programme selector to the "Stop" position.</li><li>– Switch the dishwasher off using the "On/Off" button.</li></ul>
	Water intake is restricted.	<ul style="list-style-type: none"><li>– Open the stopcock fully.</li><li>– Check the water inlet filter and clean if necessary, see "Cleaning the water inlet filter".</li><li>– The water pressure at the intake is lower than 0.3 bar. Seek professional advice.</li></ul>
	Water outlet is restricted, water remains in the wash cabinet at the end of a programme.	<ul style="list-style-type: none"><li>– Clean the filter combination, see "Cleaning and Care".</li><li>– Clean the drain pump, see "Cleaning the drain pump and non-return valve".</li><li>– Clean the non-return valve, see "Cleaning the drain pump and non-return valve".</li><li>– Remove any kink in the drain hose.</li></ul>

# Problem solving guide

Problem	Possible cause	Remedy
<b>The "End" and "Start" indicator lights flash simultaneously at the end of a programme</b>	There may be a technical fault.	<ul style="list-style-type: none"><li>– Turn the programme selector to the "Stop" position.</li><li>– Switch the dishwasher off using the "On/Off" button.</li></ul> After a few seconds: <ul style="list-style-type: none"><li>– Switch the dishwasher on using the "On/Off" button.</li><li>– Turn the programme selector to the required programme.</li><li>– Press the "Start" button.</li></ul> If the indicator lights flash again, there is a technical fault. <ul style="list-style-type: none"><li>– Call the Miele Service Department.</li></ul>

## Problem solving guide

<b>Problem</b>	<b>Possible cause</b>	<b>Remedy</b>
<b>Knocking noise in the wash cabinet</b>	The spray arm is knocking against an item in the basket.	Interrupt the programme, rearrange items which are obstructing the spray arm.
<b>Rattling noise</b>	Items of crockery are insecure in the wash cabinet.	Interrupt the programme, rearrange the items of crockery.
<b>Knocking noise in the water pipes</b>	This may be caused by the on-site installation or the cross-section of the piping.	This has no influence on dishwasher function. If in doubt contact a suitably qualified plumber.

## Problem solving guide

<b>Problem</b>	<b>Possible cause</b>	<b>Remedy</b>
<b>The dishes are not clean</b>	The dishes were not loaded correctly. Dishes were placed inside other pieces, water could not access all surfaces.	See notes in "Loading the dishwasher".
	The outlet of the water intake pipe for the middle spray arm was covered. An insufficient amount of water flowed into the middle spray arm.	Make sure that dishes placed in the rear section of the upper basket do not cover the opening.
	The programme was not powerful enough.	Select a more intensive programme, see "Programme chart" at the end of these operating instructions.
	Not enough detergent was dispensed.	Use more detergent, see "Operating the dishwasher".
	Tall items are blocking the path of the spray arms.	Rearrange the items so that the spray arms can rotate freely.
	The spray arm jets are blocked.	Clean the spray arm jets, see "Cleaning and Care".
	The filter combination in the base of the wash cabinet is not clean or is not correctly fitted. This may cause the spray arm jets to get blocked.	Clean and/or replace the filter combination correctly. Clean the spray arm jets, see "Cleaning and Care".
	The non-return valve is open and blocked. Dirty water has flowed back into the wash cabinet.	Clean the drain pump and the non-return valve, see "Cleaning the drain pump and non-return valve".



## Problem solving guide

<b>Problem</b>	<b>Possible cause</b>	<b>Remedy</b>
<b>Dishes, cutlery and glasses are not dry or are flecked</b>	The rinse aid amount may be insufficient or the rinse aid reservoir empty.	Increase the dosage or replenish the reservoir, see "Before using for the first time".
	Crockery was taken out of the cabinet too soon.	Leave it in for longer, see "Operating the dishwasher".
	Drying heat is switched off.	Switch the "Drying heat" option back on. See "Operating the dishwasher".
<b>White residue is visible on cutlery and crockery, clouding occurs on glassware; film can be wiped off</b>	Not enough rinse aid was used.	Increase the dosage, see "Before using for the first time".
	There is no salt in the salt reservoir.	Add dishwasher reactivation salt, see "Before using for the first time".
	The salt reservoir cap has not been screwed on correctly.	Replace it making sure it screws back on correctly.
	The water softener is programmed to a setting which is too low.	Programme a higher setting, see "Before using for the first time".
	Combination dishwasher detergent tablets containing rinse aid and/or salt may have been used. These are unsuitable as long term use can impair the softener unit.	Use a standard liquid, tablet or powder detergent.
<b>Smearing appears on glassware and cutlery, there is a bluish sheen on the surface of glassware; film can be wiped off</b>	The rinse aid dosage is set too high.	Reduce the dosage, see "Before using for the first time".

## Problem solving guide

<b>Problem</b>	<b>Possible cause</b>	<b>Remedy</b>
<b>Glassware is dull and discoloured; film cannot be wiped off</b>	Glassware is not dishwasherproof. The surfaces are affected.	There is no remedy. Purchase glassware which is dishwasher-proof.
<b>Tea or lipstick stains have not been completely removed</b>	The wash temperature of the selected programme was too low.	Select a programme with a higher wash temperature.
	The bleaching effect of the detergent used is too low.	Use a different type of detergent.
<b>Plastic items are discoloured</b>	Natural dyes e.g. from carrots, tomatoes or ketchup may be the cause. The amount of detergent used or its bleaching effect was not sufficient to deal with natural dyes.	Use more detergent, see "Operating the dishwasher". Discolouration is irreversible.
<b>There are rust stains on cutlery.</b>	The salt reservoir cap has not been screwed on correctly.	Replace it making sure it screws back on correctly.
	The affected items are not corrosion resistant.	There is no remedy. Purchase cutlery which is dishwasher-proof.
	The "Pre-wash" programme was not run after dishwasher salt was added. Traces of salt have got into the wash cycle.	Always run the "Pre-wash" programme after adding dishwasher salt.

## Problem solving guide

<b>Problem</b>	<b>Possible cause</b>	<b>Remedy</b>
<b>The detergent lid cannot be closed properly.</b>	Clogged detergent residue is blocking the catch.	Remove the residue.
<b>Detergent residue is left in the dispenser at the end of a programme</b>	The dispenser was still damp when detergent was added.	Make sure the dispenser is dry before adding detergent.
<b>Water remains in the wash cabinet at the end of a programme</b>		Before rectifying the problem you must: <ul style="list-style-type: none"> <li>– Turn the programme selector to the "Stop" position.</li> <li>– Switch the dishwasher off using the "On/Off" button.</li> </ul>
	The filter combination in the wash cabinet is clogged.	Clean the filter combination, see "Cleaning and Care".
	The drain pump or non-return valve may be blocked.	Clean the drain pump and the non-return valve, see "Cleaning the drain pump and non-return valve".
	The drain hose is kinked.	Remove any kink in the drain hose.

# Solving problems

## Cleaning the water inlet filter

A filter is incorporated in the screw connection of the valve on the water inlet hose. The filter must be cleaned when dirty, otherwise insufficient water flows into the wash cabinet.

 The plastic housing of the water connection contains an electrical component. It must not be dipped in water.

### Recommendation

If the mains water contains a large number of insoluble substances, we recommend fitting a large-area filter in the connection between the stopcock and the water inlet hose threaded union. This filter is available from the Miele Spares Dept.

### Cleaning the filter:

- Disconnect the dishwasher from the mains supply (switch off at the mains socket, pull out the plug, switch off the appropriate circuit at the fuse box or withdraw the mains fuse).
- Turn off the stopcock.
- Unscrew the inlet hose.

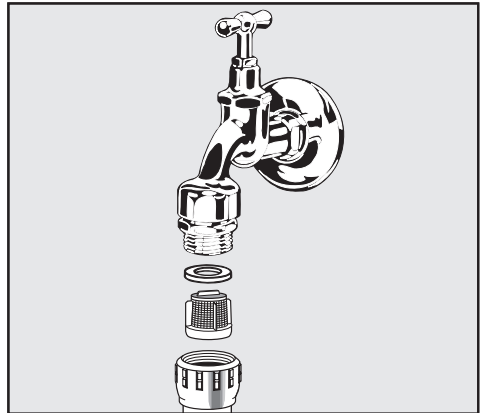

- Carefully remove the rubber seal.
- Withdraw the filter using pointed pliers and rinse clean under running water.
- Replace the filter and seal, making sure they are sitting correctly.
- Reconnect the inlet hose to the stopcock, making sure it goes on correctly and is not cross-threaded.
- Turn on the stopcock gradually to test for leaks. If there is a leak, the inlet hose might not be on securely, or it may have been screwed on at an angle. Unscrew and reconnect the water inlet valve correctly.

### Cleaning the drain pump and non-return valve

If the water has not been pumped away at the end of a programme the drain pump or the non-return valve might be blocked. They are, however, easy to clean. Watch out for glass or bone splinters which could cause injury.

- Take the filter combination out of the wash cabinet (see "Cleaning and care", "Cleaning the filters in the wash cabinet").
- Scoop the water out of the cabinet using a suitable container.
- Raise the locking clamp for the non-return valve.

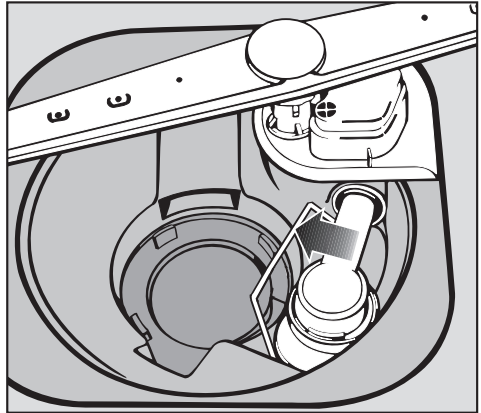

## Solving problems

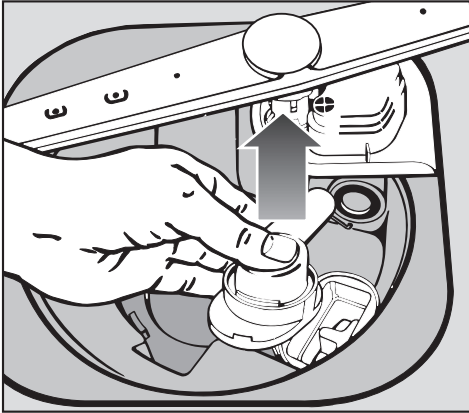

- Lift up the non-return valve and rinse well under running water.
- Remove all foreign objects from the non-return valve.

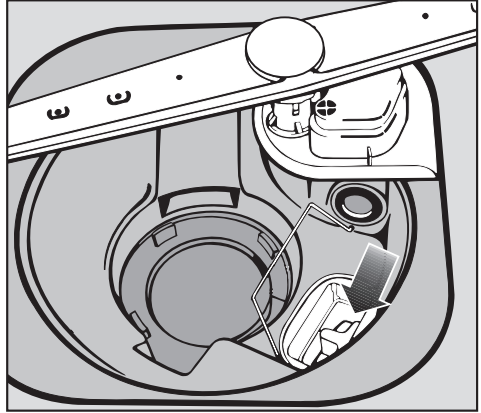

The drain pump is situated under the non-return valve (see arrow).

- Remove all foreign objects from the drain pump (watch out for glass or bone splinters which are particularly difficult to detect and could cause injury). Turn the drain pump impeller by hand to check that there are no more obstructions.
- Carefully replace the non-return valve and secure it with the locking clamp.

Should you still have any difficulties, please contact:

– Your Miele Dealer

or

– The Miele Service Department (see back cover for address).

■ Please quote the model type and number of your appliance.

This information is given on the data plate at the top of the door.

Please note that telephone calls may be monitored and recorded to improve our service.

### Programme update function - PC

The programme update function (PC = Programme correction) is designed to enable a service technician to update your machine's electronics in keeping with advances in technology.

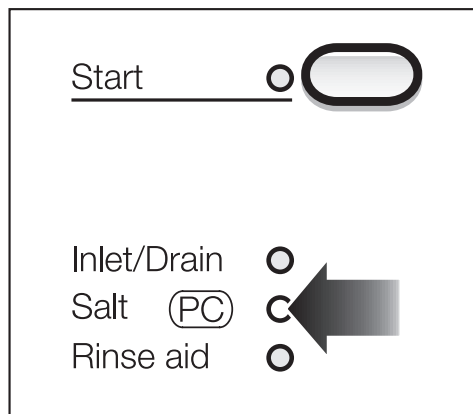

The indicator or check light marked "Salt PC" is used as the interface for this programming.

Information regarding programme updates will be made known by the Miele Company as and when such developments become available.

# Optional accessories

---

## To make the most of your dishwasher

<b>If you would like ...</b>	<b>you will need to order ...</b>
... to wash bottles, e. g. milk or baby bottles	... . a bottle holder
... . to wash long-stemmed glassware	... . a glassware insert for the upper basket
... . to wash additional items of cut- lery	... . a small cutlery basket for the lower basket



**Test standard:** EN 50242

**Standard programme for comparison tests (energy label):** Economy

**Note:** The **Universal Plus 55 °** programme for normal soiling has increased wash and drying results with shorter running times and increased energy requirements.

**Amount washed:** 12 place settings

**Amount of detergent:** 30 g only in compartment II.

**Rinse aid dispensing:** Setting 3 (approx. 3 ml)

## Dishwashers with cutlery basket

**Spoon inserts:** Fit the two inserts on top of the cutlery basket (see section on loading the dishwasher, spoon inserts)  
Place six spoons at intervals in each insert

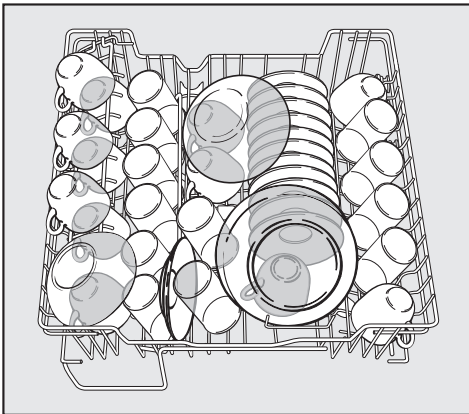

**Upper basket**

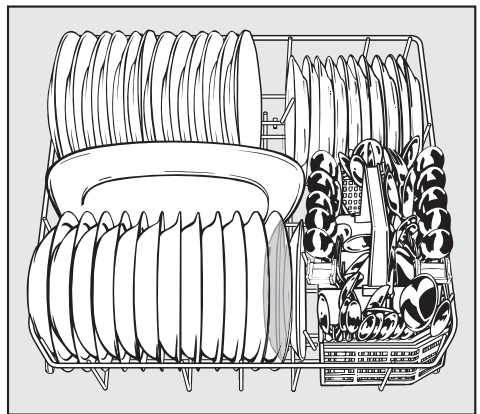

**Lower basket**

# Comparison tests

## Dishwashers with cutlery tray

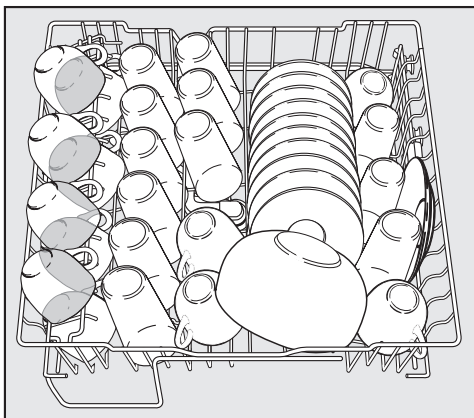

Upper basket

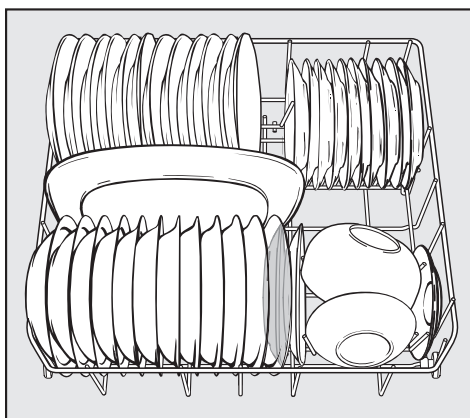

Lower basket

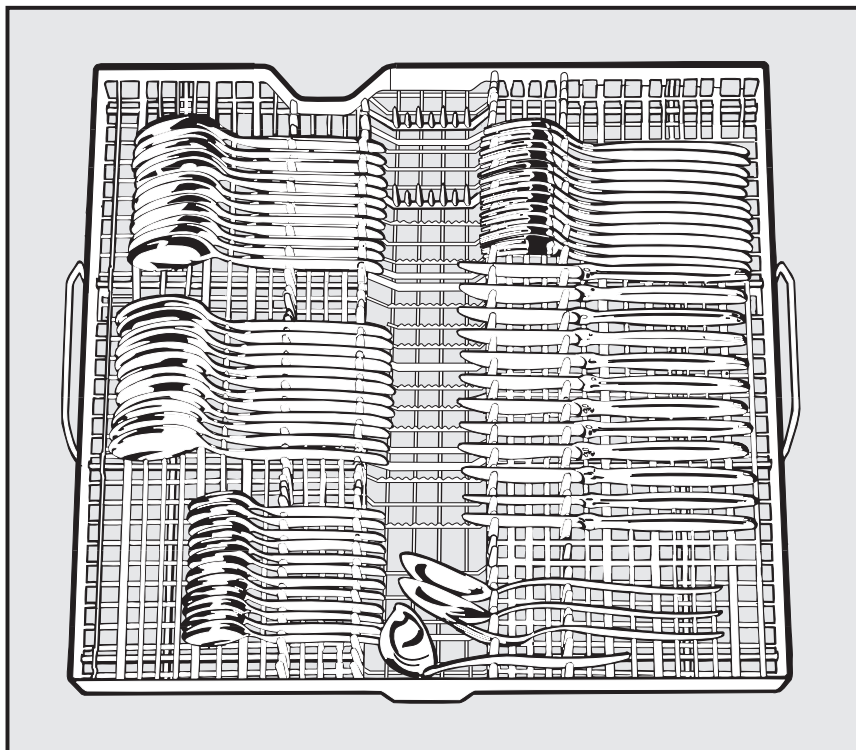

Cutlery tray

Should you ever need to move the dishwasher, e.g. when moving house, note the following:

- Empty the dishwasher,
- Secure any loose parts, e. g. hoses, mains cable, cutlery baskets, lower basket
- Transport the dishwasher in the upright position.

If unavoidable, it may be transported on its back.

Do not transport it on its side or on the door as residual water still in the appliance will leak out of it.

This residual water could get into the electronic unit and cause a fault.

# Programme chart

Programme	When to use	Detergent
		Compartment II (Wash cycle)
Intensive 75 °	for <b>normally soiled pots, pans, dishes etc</b> with <b>dried on</b> soiling; for very heavy soiling, add 20% more detergent to compartment I	100 %
Universal Plus 55 °	with a longer wash time for <b>normally soiled</b> crockery with <b>dried on</b> soiling	100 %
Universal 55 °	for <b>normal</b> everyday loads	100 %
Normal 50 °	with a shorter wash time for <b>lightly to normally soiled crockery where soiling has not dried on</b>	100 %
Economy <sup>1) 2)</sup>	for <b>normal</b> everyday loads, energy saving programme	100 %
Pre-wash	for rinsing crockery to avoid smells, if a complete cycle is not yet needed.	

1) Standard programme for energy labelling.

2) Programme with much longer, but quieter drying phase

# Programme chart

Programme sequence					Consumption			Duration	
					Energy	kWh	Water	h:min	
Pre-wash 1 2	Main wash	Interim rinse	Final rinse	Drying	Cold water connection (15 °C)	Hot water connection (55 °C)	Litres	Cold water connection (15 °C)	Hot water connection (55 °C)
	X 75 °	X	X 75 °	X	1.8	1.3	13	2:24	2:02
X	X 55 °	X	X 65 °	X	1.35	0.8	17	1:52	1:39
	X 55 °	X	X 65 °	X	1.3	0.7	13	1:24	1:11
	X 50 °	X	X 65 °	X	1.3	0.7	13	1:02	0:55
	X 45 °	X	X 60 °	X	1.05	0.6	13	2:33	2:22
X					0.06	0.06	5	0:11	0:11

When washing a full load in the Intensive Programme, the Normal programme, the Universal Plus Programme, the Universal Programme and the Economy Programme at least 30 ml of detergent are required. If the detergent manufacturer recommends using more than this you should dispense the amount they suggest.

For the Intensive Programme add an additional 5-7 ml to compartment I.

Values quoted are in accordance with EN 50242. Results in the home may differ.

## Technical data

---

Height freestanding	84,7 cm (adjustable +4.0 cm)
Height built-in	81.7 cm (adjustable +5.0 cm)
Height of building in recess	82 cm (+ 5.0 cm)
Width	59.8 cm
Width of building in recess	60 cm
Depth:	60 cm (Freestanding) 57 cm (Built-in)
Depth with door open	118.5 cm (Freestanding) 115.5 cm (Built-in)
Weight:	
Freestanding	approx. 60 kg
Freestanding SC#	approx. 61.5 kg
Integrated	approx. 51.5 kg
Integrated SC#	approx. 53 kg
Voltage	
Rated load	see data plate at the top of the door
Fuse rating	
Test marks	VDE, radio and television suppressed
Water pressure (flow rate):	0.3 - 10 bar pressure
Hot water connection	up to max. 60 °C
Delivery head:	max. 1 m
Drainage length:	max. 4 m
Connection cable	approx. 1.7 m
Capacity	12 place settings

SC # = Dishwashers with cutlery tray



**United Kingdom:**

Miele Co. Ltd.

Fairacres, Marcham Road, Abingdon, Oxon, OX14 1TW

tel. Abingdon (01235) 554455 - fax (01235) 554477

Service Office, tel. Abingdon (01235) 554466

Internet: [www.miele.co.uk](http://www.miele.co.uk)

**Ireland:**

Miele Ireland Ltd.

Broomhill Road, Tallaght, Dublin 24

Tel: (01) 46 10 710, Fax: (01) 46 10 797

Email: [info@miele.ie](mailto:info@miele.ie)

Internet: <http://www.miele.ie>

**Australia:****Miele Australia Pty. Ltd.**

A.C.N. 005635398

- 1 Gilbert Park Drive

Knoxfield, VIC 3180

Telephone: (03) 9764 7100

Fax: (03) 9764 7129

- 3 Skyline Place

Frenchs Forest, NSW 2086

Telephone: (02) 8977 4200

Fax: (02) 8977 4219

- 25 Lavarack Avenue

Eagle Farm, QLD 4009

Telephone: (07) 3632 2400

Fax: (07) 3632 2449

- 209 Richmond Road

Richmond, SA 5033

Telephone: (08) 8351 8500

Fax: (08) 8354 1717

**Distributor Western Australia:**

G.B.I. Sales Pty. Ltd.

27-33 Cleaver Terrace

Belmont, WA 6104

Telephone: (08) 9478 0466

Fax: (08) 9478 0470

**Miele Southeast Asia**

Miele Pte. Ltd.

163 Penang Road

# 04 - 02/03 Winsland House II

Singapore 238463

Tel : +65-67351161

Fax: +65-67351191

Email: [mielesea@miele.com.sg](mailto:mielesea@miele.com.sg)

**South Africa:**

Miele (Pty.) Ltd.

304 Tungsten Road

Strydom Park 2194

P.O.Box 1654, Randburg 2125

Tel. (011) 793-7452

Telefax (011) 793-7447

E-mail: [mieleza@iafrica.com](mailto:mieleza@iafrica.com)

Internet: [www.miele.co.za](http://www.miele.co.za)

**Distributor New Zealand:**

Steelfort Engineering Company, Ltd.

- 500 Rangitikei Street

Palmerston North, Priv. Bag 11045, NZ

Telephone: (06) 350 1350

Fax: (06) 356 1507

- Unit L, 10-20 Sylvia Park Road,

Mt. Wellington, Auckland, NZ

Telephone: (09) 573 1269

Fax: (09) 573 1268



## Free Manuals Download Website

<http://myh66.com>

<http://usermanuals.us>

<http://www.somanuals.com>

<http://www.4manuals.cc>

<http://www.manual-lib.com>

<http://www.404manual.com>

<http://www.luxmanual.com>

<http://aubethermostatmanual.com>

Golf course search by state

<http://golfingnear.com>

Email search by domain

<http://emailbydomain.com>

Auto manuals search

<http://auto.somanuals.com>

TV manuals search

<http://tv.somanuals.com>