

Operating instructions

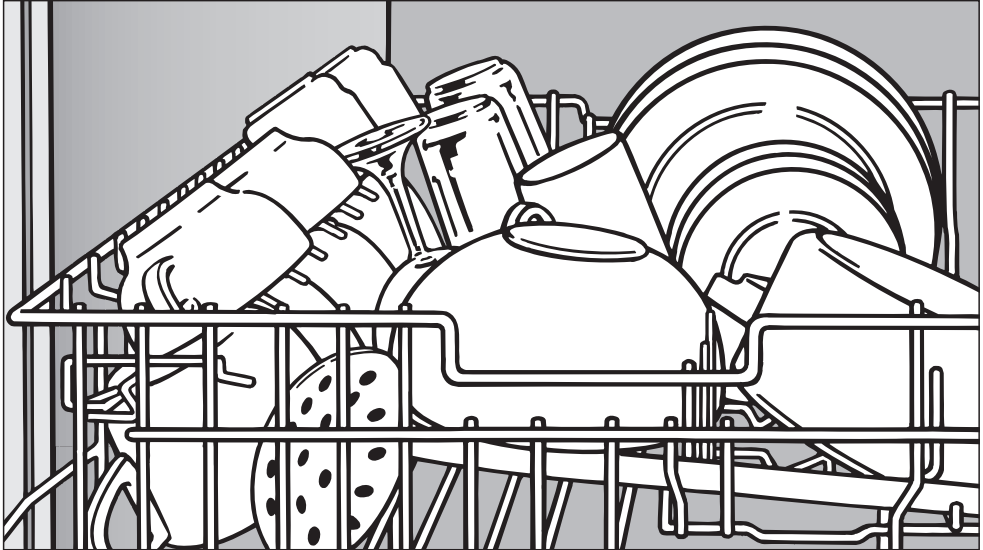

for dishwashers

To avoid the risk of accidents or damage to the appliance, it is **essential** to read these instructions as well as the installation plan before it is installed and used for the first time.

en - GB





M.-Nr. 07 502 390

Contents

Guide to the appliance	5
Appliance overview	5
Control panel	6
Display	7
Miele@home	8
Information is displayed via:	8
Optional accessories	8
The home of the future	8
Warning and Safety instructions	9
Caring for the environment	14
Disposal of the packing material	14
Disposal of your old appliance	14
Energy saving washing	15
Before using for the first time	16
To open the door	16
To close the door	16
Child safety lock	16
Setting the language.	17
Clock display	17
Setting the time of day	18
Display	18
Before using the appliance for the first time, you require:	19
External water softening system	19
Filling the salt reservoir	19
Salt indicator	21
Rinse aid	22
Adding rinsing agent	22
"Rinse aid low" message	23
Loading the dishwasher	24
Items not suitable for dishwashers:	25
Upper basket	26
Removable spiked insert	26
Hinged cup rack	27
Positioning rail (depending on model)	27
Support rail	28
Adjusting the upper basket	29

Lower basket	30
Vario inserts	30
Bottle holder	31
Cutlery	32
Cutlery tray (depending on model).	32
Cutlery basket (depending on model)	33
Operation	34
Detergent	34
Adding detergent.	35
Switching on	36
Select programme	36
Selecting Extra options	37
Starting a programme	38
Display	38
At the end of a programme	39
Switching off	39
Unloading the dishwasher	39
Interrupting a programme	39
Changing a programme	40
Additional functions	41
Delay start	41
Cleaning and care	43
Cleaning the wash cabinet	43
Cleaning the door and the door seal	43
Cleaning the door front	43
Checking the filters in the wash cabinet	44
Cleaning the filters	44
Cleaning the spray arms	46
Problem solving guide	47
Technical problems	47
The dishwasher does not fill/drain.	49
General problems	51
Noises	53
Unsatisfactory washing result	54
Maintenance	57
Cleaning the water inlet filter	57
Cleaning the drain pump and non-return valve	58

Contents

After sales service	59
Repairs	59
Future updates	59
For testing institutes	59
Programme chart	60
Optional accessories	66
Electrical connection	67
Plumbing	68
The Miele waterproof anti-leak system	68
Connection to the water supply	68
Drainage	69
Technical data	70
Settings menu 	71
To open the Settings  menu	71
Language 	72
Time	72
Detergent type	73
Drying plus	74
Water hardness	74
External water softener	75
Rinse aid	75
Check filters	75
Adjust Sensor wash	75
Change main menu	76
Save extras	77
System lock	78
Temperature	79
Volume	79
Brightness	80
Contrast	80
Memory	80
Showroom programme	81
Factory default	81
To close the Settings  menu	81

Appliance overview

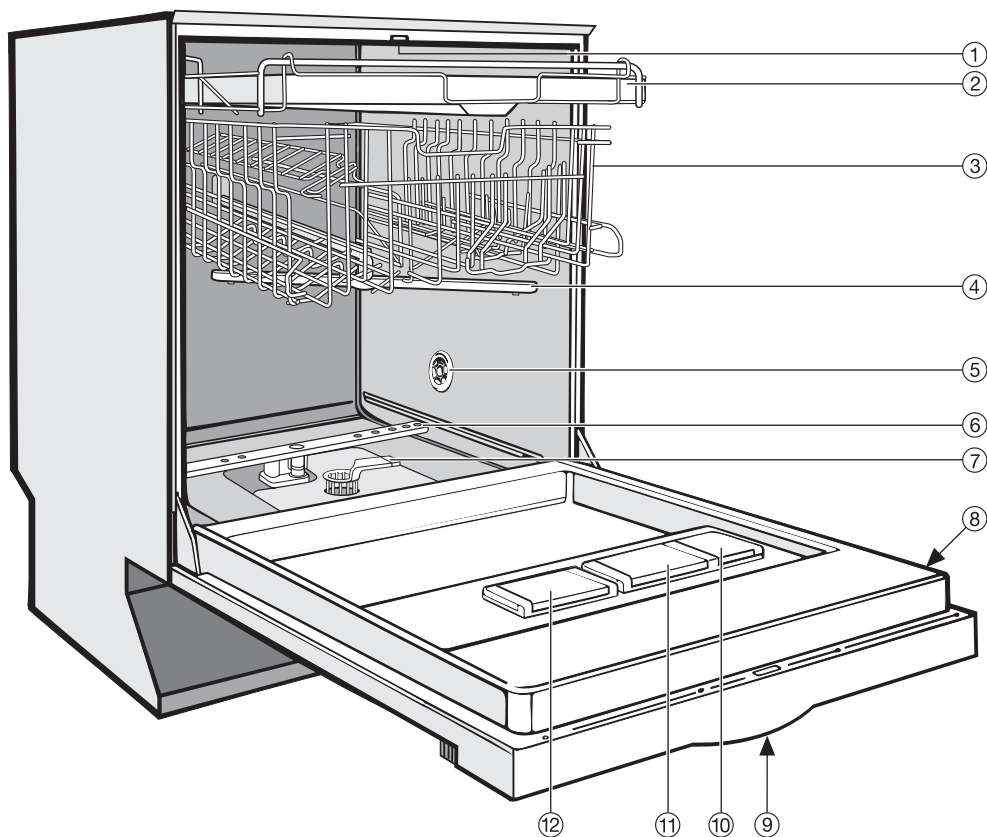

- | | |
|---|--|
| ① Upper spray arm (not visible) | ⑦ Filter combination |
| ② Cutlery tray (depending on model) | ⑧ Data plate |
| ③ Upper basket | ⑨ Child safety lock in door grip (not visible) |
| ④ Middle spray arm | ⑩ Rinse aid reservoir |
| ⑤ Air inlet for drying (depending on model) | ⑪ Dual compartment detergent dispenser |
| ⑥ Lower spray arm | ⑫ Salt reservoir |

Guide to the appliance

Control panel

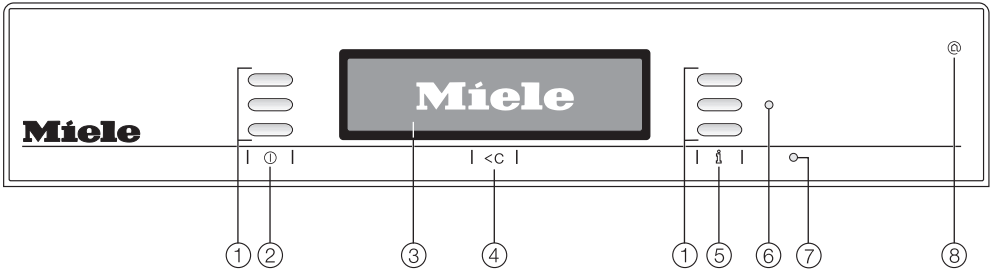

① Selector sensors

For selecting the option displayed next to them.

For altering the values displayed (+/-).

For navigating to further screens.

The selector sensors light up when active.

② On/Off sensor ①

For switching the appliance on and off.

③ Display

See next page for more information.

④ Clear sensor <C

For navigating back to the previous menu or deleting values which have been set previously.

⑤ Information sensor i

For displaying additional information about the menu being displayed.

⑥ Stand-by indicator light

When the dishwasher is switched on, the indicator light comes on if the display is switched off.

⑦ Service interface

Used by service technicians to run diagnostic checks on your appliance, or to update programming data in the future.

⑧ Miele@home

The appliance is compatible with the Miele@home system.

This instruction book applies to several different dishwasher models.

The specific dishwasher models below are referred to as follows:

G 1833 etc. = G 1XXX

G 2833 etc. = G 2XXX

The model numbers G 1XXX and G 2XXX used in this book refer to the model designation specified on the data plate of the appliance (and not the description on the control panel).

The data plate is located at the top right hand side of the door.

Display



The display is used to select the following:

- the programme
- extras
- the delay start time
- the Settings menu 
- information

During a programme, the display shows the following:

- the name of the programme
- the current time of day
- the stage the programme is at
- the estimated time left for the programme to run
- any relevant fault messages and notes

To save energy the display goes out after 10 minutes if you do not touch any sensors during this time. Touching any sensor will switch the display back on again.

 A dot in the display next to a selector sensor indicates that a function can be selected with that sensor. The relevant sensor lights up.



The arrows on the right of the display indicate that more options or more text are available which can be displayed by touching the relevant illuminated selector sensor.

A dotted line will appear after the last option available.

OK

The **OK** function is used to confirm a message or setting, and also to move to the next menu or to another menu level.



A tick will appear beside the option which is currently selected.

The Settings menu  is used to alter the dishwasher's electronics to suit different requirements. See Settings menu for more details.

Miele@home

Miele@home enabled appliances send information via the household wiring network to the master appliance ④ / ⑤ about the operational status of the appliances, as well as information about the progress of the programme.

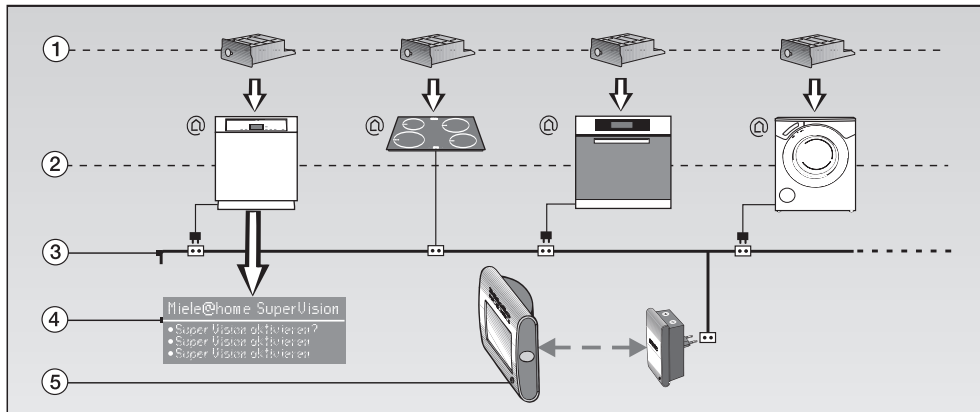

These instructions are for a communication enabled dishwasher ② that can be linked into the Miele@home system via a communication module ① (optional accessory).

Information is displayed via:

- The SuperVision appliance ④

This dishwasher is also equipped with the Miele@home Supervision facility, and can be used as the master appliance.

- InfoControl XIC 2100 ⑤
Information transmitted from the appliances can be displayed acoustically and optically in a mobile master unit in the vicinity of the house.

You can use both of these at the same time.

Optional accessories

- Required: Communication module XKM 2000 SV ①
- Optional: Mobile master unit InfoControl XIC 2100 ⑤

Both of these are supplied with their own installation and operating instructions.

The home of the future

The Miele@home system is capable of expansion. In the future, communication enabled appliances ② will be able to be operated via a PC or a mobile phone.

Warning and Safety instructions

This appliance conforms to current safety requirements. Inappropriate use can, however, lead to personal injury and damage to property. To avoid the risk of accidents and damage to the appliance, please read these instructions carefully before using it for the first time. They contain important information on its safety, use and maintenance. Keep these instructions in a safe place and pass them on to any future owner.

Correct application

► This dishwasher is intended exclusively for cleaning domestic crockery and cutlery in a domestic household. Using it for purposes other than those for which it was designed, as well as any alterations or conversions to the appliance, would be unauthorised and could be dangerous. The manufacturer cannot be held liable for damage resulting from improper or incorrect use of the appliance.

► This dishwasher is not intended for use by persons (including children) with reduced physical, sensory or mental capabilities, or lack of experience and knowledge, unless they are supervised whilst using it or they have been shown how to use it correctly by a person responsible for their safety.

Safety with children

► This appliance is not a toy! To avoid the risk of injury, keep children well away and do not allow them to play in or around the dishwasher, or to use the controls. They will not understand the potential dangers posed by it. They should be supervised whenever you are working in the kitchen. There is a danger that children playing might shut themselves in the dishwasher.

► Older children may only use the dishwasher when its operation has been clearly explained to them and they are able to use it safely, recognising the dangers of misuse.

► Keep children away from detergents. Dishwasher detergents contain irritant and corrosive ingredients which can cause burning in the mouth, nose and throat if swallowed, or inhibit breathing. Keep children away from the dishwasher when the door is open. There could still be detergent residues in the cabinet. Consult a doctor immediately if your child has swallowed or inhaled detergent.

Warning and Safety instructions

Technical safety

▶ Before setting up the appliance, check it for any externally visible damage. Under no circumstances should you use a damaged appliance. A damaged appliance could be dangerous.

▶ The dishwasher must only be plugged into the electricity supply via a suitable switched socket. The electrical socket must be easily accessible after the dishwasher has been installed so that it can be disconnected from the electricity supply at any time. (See "Electrical connection").

▶ There must be no electrical sockets behind the dishwasher. Danger of overheating and fire risk if the dishwasher were to be pushed up against a plug.

▶ The dishwasher must not be installed under a hob. The high radiant temperatures which are sometimes generated by a hob could damage the dishwasher. For the same reason it should not be installed next to open fires or other appliances which give off heat, such as heaters etc.

▶ Do not connect the dishwasher to the mains supply until it has been fully installed.

▶ Before connecting the appliance, check that the connection data on the data plate (voltage and connected load) match the mains electricity supply. If in any doubt, consult a qualified electrician.

▶ The electrical safety of this appliance can only be guaranteed when continuity is complete between it and an effective earthing system. It is most important that this basic safety requirement is present and regularly tested and where there is any doubt the electrical system in the house should be checked by a qualified electrician. The manufacturer cannot be held liable for the consequences of an inadequate earthing system (e.g. electric shock).

▶ Do not connect the appliance to the mains electricity supply by a multi-socket unit or an extension lead. These do not guarantee the required safety of the appliance (e.g. danger of overheating).

Warning and Safety instructions

▶ This appliance may only be installed in mobile installations such as ships if a risk assessment of the installation has been carried out by a suitably qualified engineer.

▶ The plastic housing of the water connection contains an electrical component. The housing must not be dipped in water.

▶ There are live wires in the water inlet hose. Never cut the water inlet hose, even if it is too long.

▶ The integrated Waterproof System offers protection from water damage, provided the following conditions are met:

- The dishwasher is correctly installed and plumbed in.
- The dishwasher is properly maintained and parts are replaced where necessary.
- The stopcock has been turned off when the appliance is not used for a longer period of time (e.g. during holidays).

The Waterproof system will work even if the appliance is switched off. However, the appliance must remain connected to the electricity supply.

▶ A damaged appliance could be dangerous. If the dishwasher gets damaged, switch it off at the mains and call your Miele Dealer or the Miele Service Department.

▶ Unauthorised repairs could result in unforeseen dangers for the user, for which Miele cannot accept liability. Repairs should only be undertaken by a Miele approved service technician.

▶ Faulty components must only be replaced by genuine Miele original spare parts. The manufacturer can only guarantee the safety of the appliance when Miele replacement parts are used.

▶ Always disconnect the dishwasher from the electrical supply for maintenance work (switch off at the wall socket and remove the plug).

▶ If the connection cable is damaged it must be replaced with a Miele cable by a Miele approved service technician only.

▶ In countries where there are areas which may be subject to infestation by cockroaches or other vermin, pay particular attention to keeping the appliance and its surroundings in a clean condition at all times. Any damage which may be caused by cockroaches or other vermin will not be covered by the guarantee.

Warning and Safety instructions

Installation

- ▶ The dishwasher must be installed and connected in compliance with the installation diagram supplied.
- ▶ The dishwasher must be correctly aligned to ensure problem-free operation.
- ▶ In order to ensure stability, built-under and integrated dishwashers must only be installed under a continuous worktop which is secured to adjacent cabinetry.
- ▶ If you want to convert your freestanding dishwasher to a built-under ("U") model, you will need to order the appropriate conversion kit. If you remove the existing plinth, you must replace it with a U-model plinth. This is necessary to avoid the risk of injury caused by protruding metal parts.

Correct use

- ▶ Do not use solvents in the dishwasher. Danger of explosion.
- ▶ Do not inhale or ingest dishwasher detergent. Dishwasher detergents contain irritant or corrosive ingredients which can cause burning in the nose, mouth and throat if swallowed, or inhibit breathing. Consult a doctor immediately if detergent has been swallowed or inhaled.
- ▶ Avoid leaving the door open unnecessarily, as you could trip over it.
- ▶ Do not sit or lean on the opened door. This could cause the dishwasher to tip and be damaged, and you could get injured.
- ▶ Only use detergent and rinse aid formulated for domestic dishwashers. Do not use washing-up liquid.
- ▶ Do not use commercial or industrial detergents as these may cause damage, and there is a risk of severe chemical reaction.
- ▶ Do not fill the rinse aid reservoir with powder or liquid detergent. This will cause serious damage to the reservoir.

Warning and Safety instructions

▶ Inadvertently filling the salt reservoir with powder or liquid dishwasher detergent will damage the water softener. Make sure you have picked up the correct packet of dishwasher salt before filling the salt reservoir!

▶ Please only use special coarse grained dishwasher salt for reactivation, as other salts may contain insoluble additives which can impair the functioning of the softener.

▶ In an appliance with a cutlery basket (depending on model) cutlery is cleaned and dried more efficiently if placed in the basket with the handles downwards. However, to avoid the risk of injury, place knives and forks etc. with the handles upwards.

▶ Plastic items which cannot withstand being washed in hot water, such as disposable plastic containers, or plastic cutlery and crockery should not be cleaned in the dishwasher. The high temperatures in the dishwasher may cause them to melt or lose shape.

▶ On models with "Delay start", make sure that the dispenser is dry before adding detergent. Wipe dry if necessary. Detergent will clog if poured into a damp dispenser and may not be thoroughly dispersed.

Accessories

▶ Only use genuine Miele spare parts and accessories with this appliance. If spare parts or accessories from other manufacturers are used, this will invalidate the guarantee, and Miele cannot accept liability.

Disposal of your old dishwasher

▶ Make the door lock inoperative so that children cannot accidentally shut themselves in. Make appropriate arrangements for the disposal of the appliance.

The manufacturer cannot be held liable for damage caused by non-compliance with these Warning and Safety instructions.

Caring for the environment

Disposal of the packing material

The transport and protective packing has been selected from materials which are environmentally friendly for disposal and can normally be recycled.

Ensure that any plastic wrappings, bags, etc. are disposed of safely and kept out of the reach of babies and young children. Danger of suffocation.

The packaging consists of the following materials:

Outer packaging:

- Corrugated cardboard made from up to 100% recyclable material:
or: Polyethylene (PE) shrink wrap
- Polypropylene (PP) strapping

Inner packaging:

- Chlorine and fluorine free expanded polystyrene (EPS)
- Base, lid frame and support battens made from untreated natural wood from renewable forests
- Polyethylene (PE) protective wrap

Rather than just throwing these materials away, please ensure they are recycled.

Disposal of your old appliance

Electrical and electronic appliances often contain materials which, if handled or disposed of incorrectly, could be potentially hazardous to human health and to the environment. They are, however, essential for the correct functioning of your appliance. Please do not therefore dispose of it with your household waste.

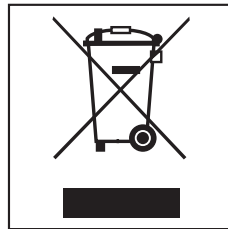

Please dispose of it at your local community waste collection/recycling centre and ensure that it presents no danger to children while being stored for disposal.

To enable sorting by type of plastic for recycling, all plastic parts of the appliance are labelled with international standard symbols.

Energy saving washing

This dishwasher is exceptionally economical in its use of water and electricity. You can make the most of your appliance by following these tips:

- For most economical dishwashing make full use of the baskets without overloading the dishwasher.
- Choose the programme to suit the type of crockery being washed and the degree of soiling.
- Select the **Energy save** programme for energy-saving dishwashing.
- If your household water system is suitable, this dishwasher can be connected to a hot water supply. Select **Without heater** when washing lightly to normally soiled dishes.
The water will not be heated in this programme. However, because the water is not heated, drying results may not match those of other programmes.
- Follow the detergent manufacturer's recommendations on detergent dosage.
- When using powder or liquid detergent you can use $\frac{1}{3}$ less detergent if baskets are only half full.

Before using for the first time

To open the door

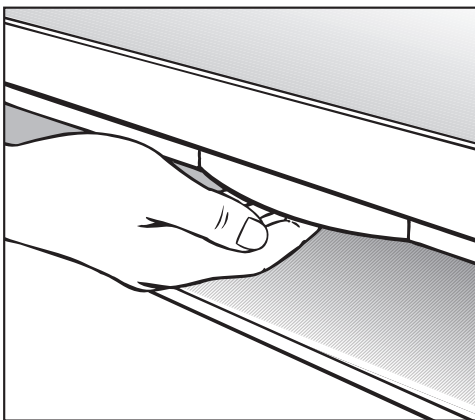

At the end of programmes with a drying phase (see "Programme chart") the door will open automatically a little in order to help the drying process. This function can be deactivated (see "Settings menu, Drying plus").

- Press the release catch inside the door grip upwards to open the door.

If the door is opened during operation all functions are automatically interrupted.

 Keep the area around the door free of obstructions.

To close the door

- Push the baskets right in.
- Then raise the door upwards until the catch engages.

The door will then close automatically.

 Do not put your hand inside the door as it is closing: you may catch your fingers. Danger of injury.

Child safety lock

Use the safety lock to prevent children opening the dishwasher door.

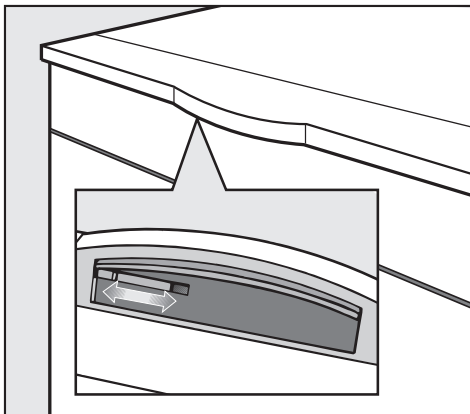

- To lock the door, push the slide underneath the door grip to the right.
- To unlock the door, push the slide to the left.

Before using for the first time

Welcome screen

- Switch the dishwasher on using the ① sensor.

If the dishwasher is being switched on for the first time, the welcome screen will appear.

Setting the language

The display will then change automatically to the screen for setting the language.



- Select the language you want and confirm this with OK.
A tick ✓ will appear next to the language that has been set.

Clock display

The display will then change to the screen for setting the clock display.



- Select the clock display you require, and confirm this with OK.

Before using for the first time

Setting the time of day

The display will then change to the screen for setting the time.



- Set the hours with the +/- sensors and confirm with OK. Then set the minutes, and confirm with OK.

Display

The display will then change to the screen for setting the display for the time of day.

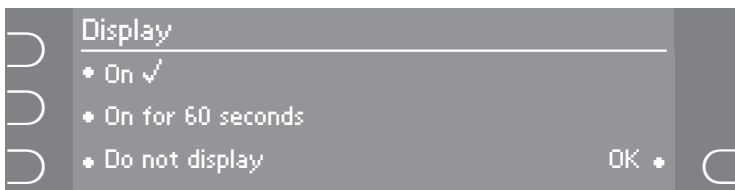

- Select the display you require for the time of day, and confirm this with OK.

These settings will be saved in memory after the dishwasher has been through one complete programme.

Finally, two prompts come up in the display.

After confirming these messages, the Rinse aid low and Insufficient salt messages may then appear in the display to remind you to fill the rinse aid and salt reservoirs. See relevant sections on how to do this. After you have confirmed these messages with OK, the display will change to show the main menu.

You can now select a programme and start it, or switch the dishwasher off.

Before using for the first time

Miele branded products are available from the Miele Spare Parts Department or via the internet at www.miele-shop.com.

Before using the appliance for the first time, you require:

- Approx. 1 kg dishwasher salt,
- Domestic dishwasher detergent,
- Rinse aid formulated for domestic dishwashers.

Every dishwasher is tested at the factory. There will be residual water in the appliance from this test. It is not an indication that it has been used previously.

This dishwasher is fitted with a water softener sensor which automatically sets the water softener unit for the local water hardness level.

External water softening system

If your dishwasher is connected to an external water softening system which uses salt to reactivate, you will still need to programme the dishwasher to the correct water hardness level to achieve good cleaning results.

- Set the water softener unit of the dishwasher to the water hardness level of the water which is supplied from the external water softening system. If you do not know what this is, then set the value at 1.4 mmol/l (8 °d) (see Settings menu , External water softener).

Filling the salt reservoir

In order to achieve good cleaning results, the dishwasher needs to operate with soft water. Hard water results in the build-up of calcium deposits on crockery and in the dishwasher.

Mains water with a hardness level higher than 0.7 mmol/l (4 °d – German scale) needs to be softened. This takes place automatically in the integrated softener unit.

The softener unit is suitable for a water hardness level of up to 12.6 mmol/l (70 °d). It requires dishwasher salt.

If you use combination products which have salt in them in your dishwasher, such as "3 in 1" or "4 in 1" products, you should still add salt in order to achieve optimum results and to ensure that the water softener continues to function. Selecting the Combination tabs function reduces salt consumption to between $\frac{1}{4}$ and $\frac{1}{3}$ of the normal amount. (See Settings menu , Detergent type).

Before using for the first time

You can check the water hardness level measured by the water softener sensor in the display (see Settings menu , Water hardness).

If the water in your area is very soft and constantly **lower** than 0.7 mmol/l (4 °d) you do not need to add salt. The "Insufficient salt" message will be deactivated automatically.

 Inadvertently filling the salt reservoir with powder or liquid dishwasher detergent will damage the water softener. Make sure you have picked up the correct packet of dishwasher salt before filling the salt reservoir!

 Only use special coarse grained dishwasher salt for reactivation. Do not use other salts such as cooking salt, agricultural grade or gritting salt. These may contain insoluble additives which can impair the functioning of the water softener.

- When filling the salt reservoir **only open the door halfway** to ensure that all the salt gets into the reservoir.

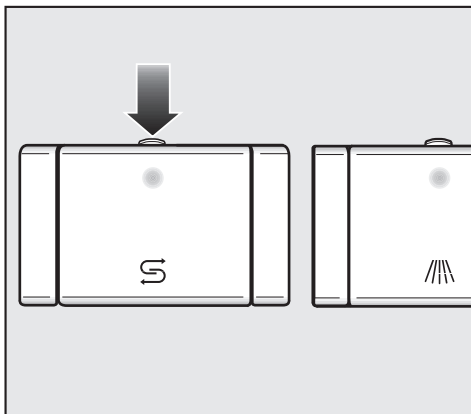

- Press the button on the lid of the salt reservoir in the direction of the arrow until the flap springs open.

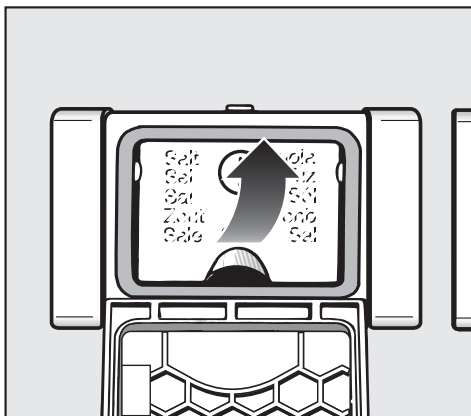

- Lift up the funnel.

Before using for the first time

Do not fill the salt reservoir with water.

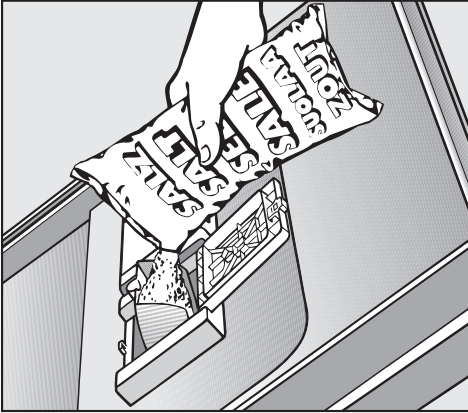

- Add salt only until the reservoir is full or until water runs out of the opening. The salt reservoir holds approx. 1 kg of salt, depending on the brand used.

Do not add any more than 1 kg of salt.

As the salt reservoir is filled, displaced water may overflow.

- Clean any excess salt from around the reservoir opening, and then close the flap.
- After filling the salt reservoir, run the **Quick wash** programme immediately (without any crockery in the dishwasher, and without selecting the Turbo extra option) to remove any traces of salt from the cabinet.

Salt indicator

- Fill the salt reservoir with dishwasher salt for reactivation when the **Insufficient salt** message appears. (If it appears during a programme, wait until the end of the programme).
- Confirm with OK.

The "Insufficient salt" message will go out.

After the salt reservoir has been filled, the "Insufficient salt" message may still appear in the display if the salt concentration has not yet reached the correct level.

If this is the case, confirm again with OK.

The insufficient salt message will not come on if the dishwasher has been programmed for a water hardness level of less than 0.7 mmol/l (4 °d - German scale).

 After filling the salt reservoir, run the **Quick wash** programme immediately (without any crockery in the dishwasher, and without selecting the Turbo extra option) to remove any traces of salt from the cabinet.

Before using for the first time

Rinse aid

Rinse aid is necessary to ensure water does not cling and leave marks on crockery during the drying phase and helps crockery dry faster after it has been washed.

Rinse aid is poured into the storage reservoir and the amount set is dispensed automatically.

 Inadvertently filling the rinse aid reservoir with powder or liquid detergent will damage the reservoir. Only pour rinse aid formulated for domestic dishwashers into the reservoir.

Alternatively, it is possible to use

- Household vinegar with a max. 5% acid content

or

- Liquid citric acid up to 10% acid content. The resulting rinsing and drying quality will not, however, be as good as when rinse aid is used.

 Do not use vinegar with a higher acid content (e.g. vinegar essence 25% acid). This would damage the dishwasher.

If you only ever use combination products containing rinse aid in your dishwasher, you do not need to add rinse aid.

Adding rinsing agent

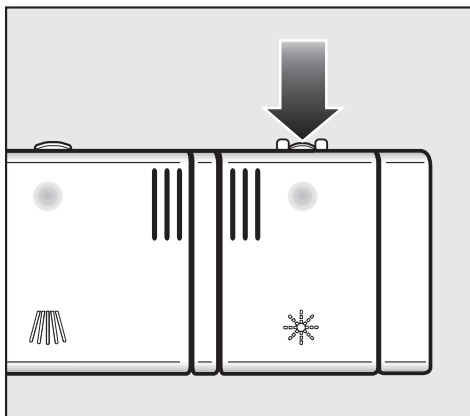

- Press the button on the lid of the rinse aid reservoir in the direction of the arrow until the flap springs open.

Before using for the first time

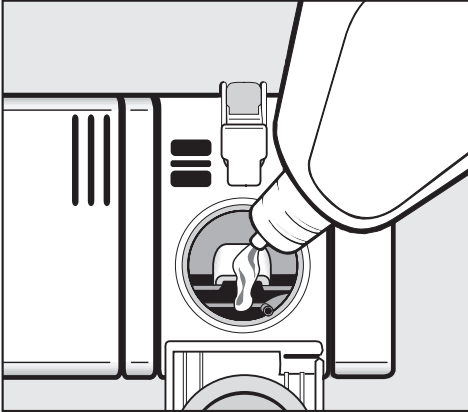

- Add rinse aid only until it is visible in the opening.

The rinse aid reservoir holds approx. 110 ml.

- Close the flap firmly so that it clicks into place. Otherwise water can enter the rinse aid reservoir during a programme.
- Wipe up any spilled rinse aid. This prevents over-foaming occurring during the next programme.

You can adjust the rinse aid dosage for best results (see Settings menu , Rinse aid).

"Rinse aid low" message

When the **Rinse aid low** message appears, the reservoir contains sufficient rinse aid for 2 - 3 programmes only.

- Add rinse aid in plenty of time.

If the 2 in 1 or Combi tab function has been selected, the **Rinse aid low** message will not appear (see Settings menu , Detergent type).

- Confirm with **OK**.

The **Rinse aid low** message will go out.

Loading the dishwasher

Note

Remove coarse food residues from crockery.

There is no need to rinse items under running water.

 Do not wash items soiled with ash, sand, wax, lubricating grease or paint in the dishwasher. These substances will damage the dishwasher.

Crockery can be loaded anywhere in the baskets, but the following notes should be observed:

- Do not place crockery and cutlery inside other pieces where they may be concealed.
 - Load the crockery so that water can access all surfaces. This ensures that they get properly cleaned.
 - Make sure that all items are securely positioned.
 - Hollow items such as cups, glasses, pans, etc. must be inverted in the basket.
 - Tall, narrow, hollow items, e.g. champagne glasses, should be placed in the centre of the basket to ensure better water coverage.
- Wide based items should be placed at an angle so that water can run off them freely.
 - The spray arms must not be blocked by items which are too tall or hang through the baskets. If in doubt, test for free movement by manually rotating the spray arms.
 - Make sure that small items cannot fall through the holders in the baskets. Small items, e.g. lids, should therefore be placed in the cutlery tray or cutlery basket (depending on model).

Some foodstuffs may contain natural dyes, e.g. carrots, tomatoes or ketchup. Plastic items in the dishwasher may discolour if large quantities of these foodstuffs find their way into the appliance on the crockery. The stability of plastic items is not affected by this discolouration.

Items not suitable for dishwashers:

- Wooden cutlery and crockery or items with wooden parts: these may discolour and fade. The glue used in these items is not dishwasher-proof and wooden handles may come loose after being washed in a dishwasher.
- Craft items, antiques, valuable vases and decorative glassware are also not suitable for dishwashers.
- Plastic items which are not heat resistant: the high temperatures in the dishwasher may cause them to melt or lose shape.
- Copper, brass, tin and aluminium items may discolour or become matt.
- Colours painted over a glaze may fade after a number of washes.
- Clouding may occur on glasses after frequent washing. Do not wash delicate glassware, or glassware containing lead crystal in a dishwasher.

We recommend:

- When purchasing new crockery and cutlery, make sure they are dishwasher-proof.
- If delicate glassware is washed in the dishwasher ensure that only very low temperatures are used (see programme chart), or a special glass-care programme is used (depending on model). This will reduce the risk of clouding.
- If in doubt, wash delicate glassware by hand.

Please note

Silverware previously cleaned with a **silver polish** may still be damp or spotted at the end of a programme, where water has not run off smoothly. It may need to be rubbed dry with a soft cloth.

Silver which has been in contact with foods containing sulphur can discolour. These include egg yolk, onions, mayonnaise, mustard, pulses, fish, fish brine and marinades.

 Aluminium components (e.g. grease filters) must not be cleaned with caustic alkaline commercial or industrial cleaning agents. These may damage the material, or in extreme cases, cause a severe chemical reaction. See section "Adding detergent" for information on suitable detergents.

Loading the dishwasher

Upper basket

 For safety reasons, do not operate the dishwasher without the upper and lower baskets in place (except when running the **Tall items 65°C** programme).

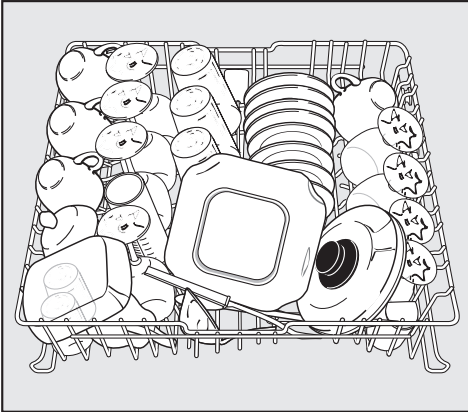

- Use the upper basket for small, lightweight and delicate items such as cups, saucers, glasses, dessert bowls, etc. Shallow pans or casserole dishes can also be placed in the upper basket.
- Long items such as soup ladles, mixing spoons and long knives should be placed lying down across the front of the upper basket.

Removable spiked insert

The spiked insert can be removed to make more room for larger items such as casserole dishes.

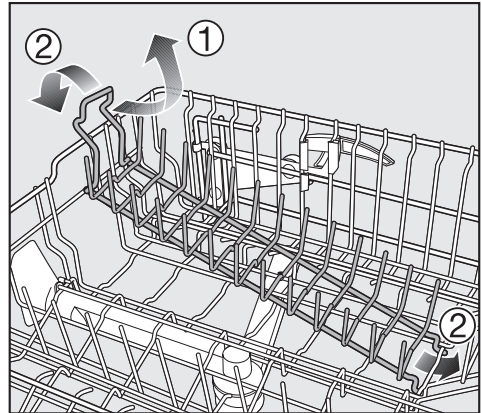

To remove the insert ①:

- Pull it upwards by the handle as shown.

To replace the insert ②:

- Fit the insert into the lower basket with the hooks going under the cross piece as illustrated.
- Press down on the handle until the insert is held securely in position.

Loading the dishwasher

Hinged cup rack

- To make room for tall items, raise the rack upwards.

G 2XXX models:

You can set the cup rack at two different heights.

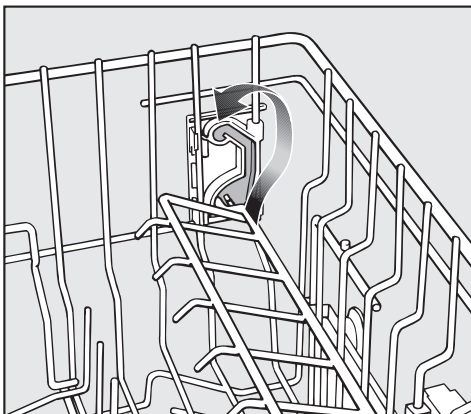

- Pull the cup rack upwards and click it back into position at the required height.

Positioning rail (depending on model)

Glasses can be arranged along the positioning rail to give them some support during the programme.

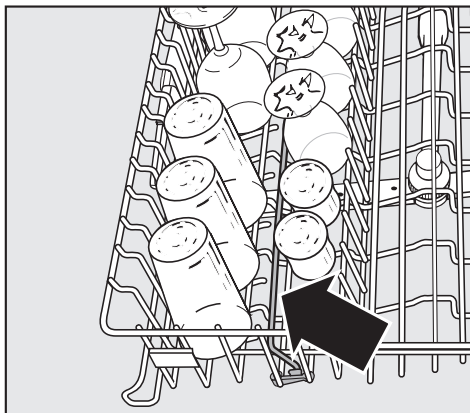

- Raise the rail, and lean the glasses against it.

The positioning rail can be flipped over to the middle of the basket for easy sorting and removing of crockery.

Loading the dishwasher

Support rail

This support is designed to hold tall glasses and glasses with stems securely.

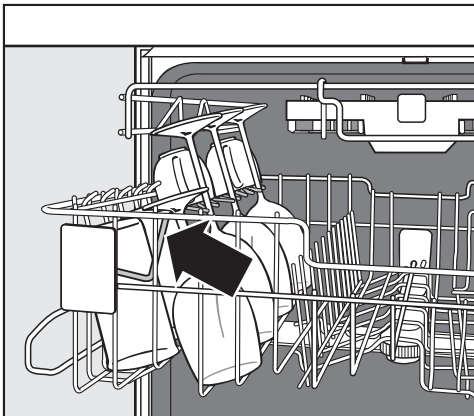

- Lower the support and lean tall glasses against it.
- You can also remove a section of the cutlery tray to make more room for tall glasses.

Loading the dishwasher

Adjusting the upper basket

In order to gain more space for taller pieces of crockery in the bottom or upper basket, the upper basket can be adjusted on three levels with 2 cm between each level.

The upper basket can also be set at an angle with one side high and the other side low. This can be useful to help prevent water collecting in deep dishes etc. Ensure, however, that the basket can be inserted smoothly into the cabinet. It is better to adjust the basket before loading it.

- Pull out the upper basket.

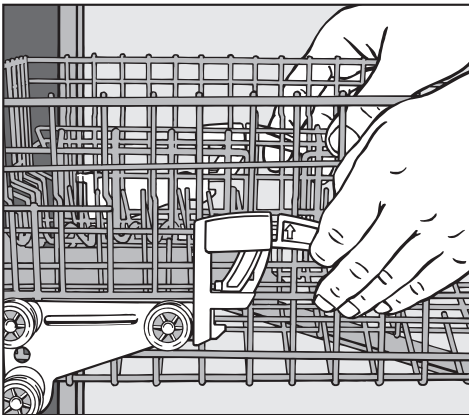

To raise the upper basket:

- Pull the basket up until it clicks into place.

To lower the upper basket:

- Pull upwards on the levers at either side of the upper basket.
- Adjust the basket to the desired height and then push the levers securely back down into position.

Depending on the setting of the upper basket, the following plate dimensions can be accommodated.

Dishwasher with cutlery tray

(see data plate for model number)

Upper basket level	Plate Ø in cm		
	Upper basket		Lower basket
	G1XXX	G2XXX	
Top	15	19	31
Middle	17	21	29
Bottom	19	23	27

Dishwasher with cutlery basket

(see data plate for model number)

Upper basket level	Plate Ø in cm		
	Upper basket		Lower basket
	G1XXX	G2XXX	
Top	20	24	31
Middle	22	26	29
Bottom	24	28	27

Loading the dishwasher

Lower basket

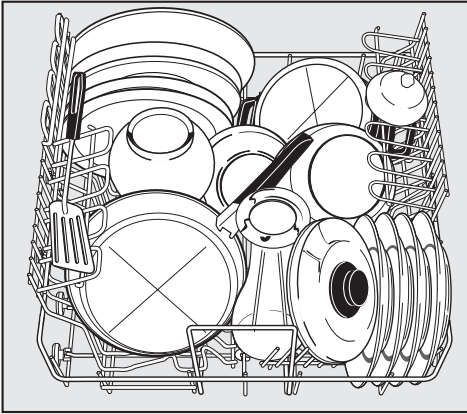

- For larger and heavier items such as plates, serving platters, saucepans, bowls, etc. Small items such as saucers can also be placed in the lower basket. Do not place delicate glassware in the lower basket.

Vario inserts

The vario inserts are used for washing cups, glasses, plates, saucers, pots and pans.

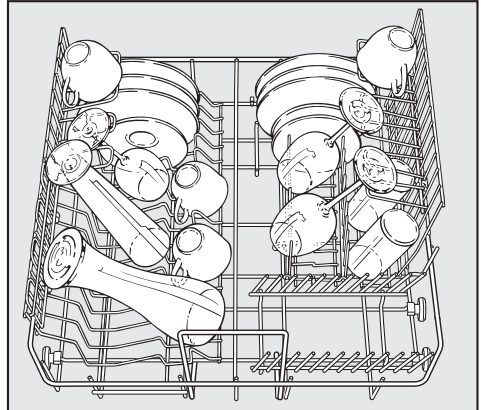

- The cup rack can be raised to make more room for tall items.
- Stem glassware e.g. wine glasses or champagne flutes can be leaned against the cup rack or suspended from it.

Loading the dishwasher

Narrow vario insert

You can remove the narrow vario insert to make more room for larger items of crockery, e.g. a large, flat pot, or another type of insert:

To remove it:

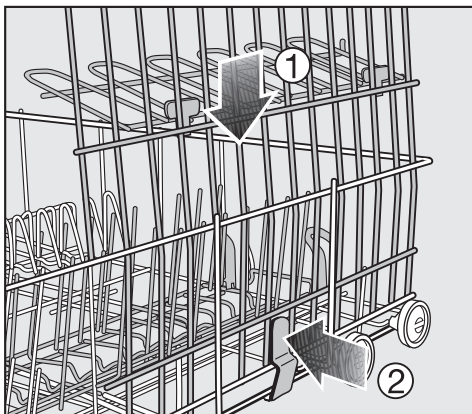

- Press the insert downwards ① and press the catch inwards at the same time ②.

To replace it:

- Position the narrow vario insert in the back right hand side of the lower basket.
- Fit the insert into the lower basket with the hooks going under the long cross-piece as illustrated.
- Press down on the insert until it clicks into position

Bottle holder

The bottle holder can be used to wash narrow items, e.g. milk and baby bottles.

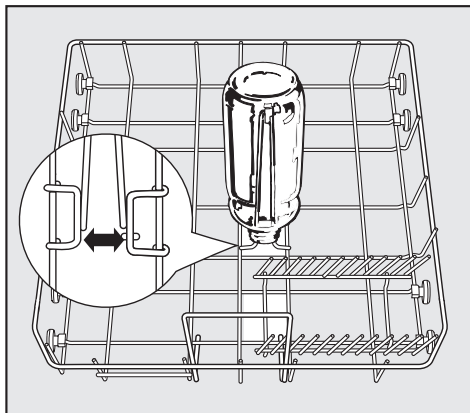

- It can be inserted into the bottom basket in more than one place. See the areas marked in white in the illustration. However, do not place a bottle holder in the corners. Water will not be able to access the bottles properly, and they will not get clean.

Loading the dishwasher

Cutlery

Cutlery tray (depending on model)

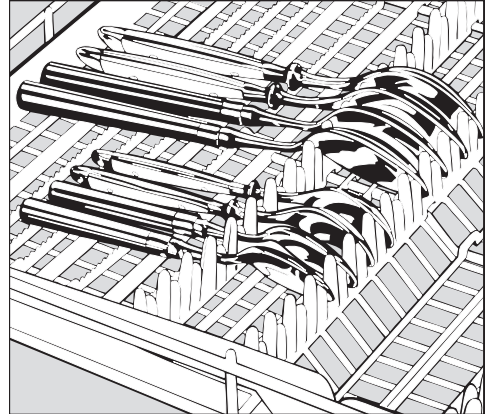
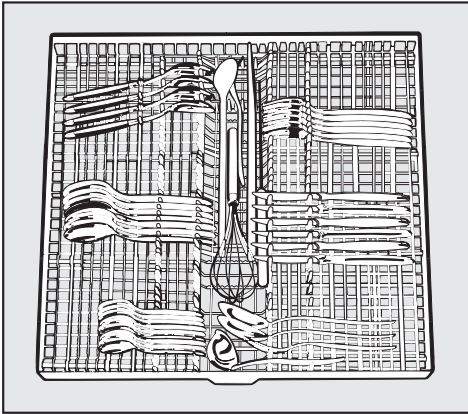

If spoon handles do not fit between the holders, then lay them the other way round.

- Arrange the cutlery in the tray as shown.

To make unloading much easier, cutlery should be grouped in zones, one for knives, one for forks, one for spoons, etc.

Spoon heads should be placed in contact with at least one of the serrated retainers on the base of the cutlery tray to ensure that water runs off them freely.

The upper spray arm must not be blocked by items which are too big (e.g. cake slices).

The cutlery tray inserts are removable. For example, you can remove one insert to make room for larger items of crockery in the upper basket.

Loading the dishwasher

Cutlery basket (depending on model)

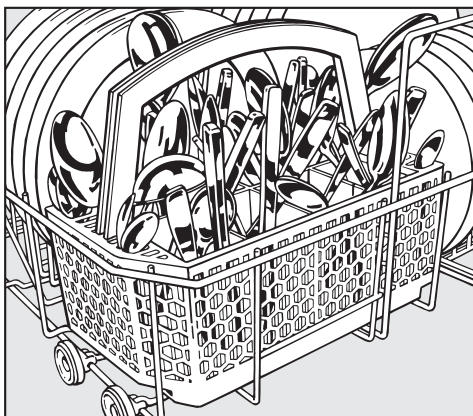

- To avoid the risk of injury, knives and forks should be placed with the handles upwards in the basket. However, cutlery placed handle down in the basket will come out cleaner and drier.
- Place small spoons in the individual slots in the cutlery basket.

Cutlery insert for the cutlery basket

Use the insert supplied for heavily soiled spoons.

The insert separates the items so that they can be more easily accessed by water.

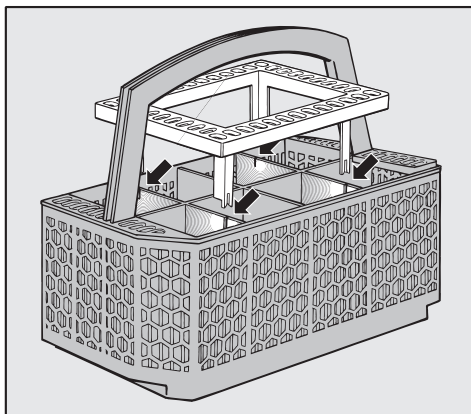

- Fit it into the cutlery basket if required.

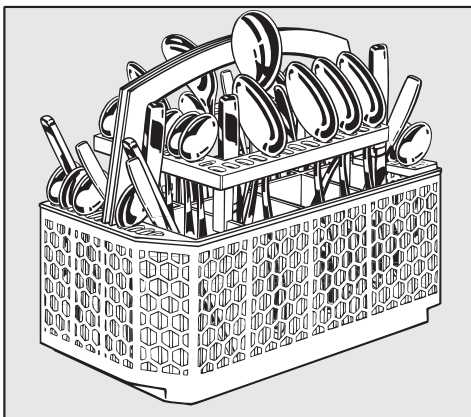

- Insert cutlery with the handles facing downwards, and distribute them evenly along the insert.

Operation

Detergent

 Only use detergents formulated for domestic dishwashers. Do not use washing-up liquid.

Miele branded dishwasher cleaning products are available from the Miele Spare Parts Department or via the internet at www.miele-shop.com.

Active ingredients

Modern detergents contain various active ingredients, the most important of which are:

- Phosphates to prevent calcification.
- Alkalis to aid removal of dried on soiling.
- Enzymes to break down starch and dissolve protein.
- Oxygen based bleaching agents to remove coloured stains (e.g. tea, coffee, tomato sauce).

Most dishwasher detergents contain phosphate and are mildly alkaline with enzymes and oxygen based bleaching agents. Phosphate free products are rare.

Types of detergent:

- Powder and liquid gel detergents. These detergents allow you to adjust the amount dispensed according to the amount of load and level of soiling.
- Tab detergents. These are suitable for most levels of soiling.

A variety of combination products is also available (see "Settings , Detergent type").

In addition to detergent, combi tabs contain rinse aid and salt substitutes. Combi tabs are available as "3 in 1" or when they also contain other components such as glass and stainless steel protective additives and enhanced cleaning power, as "4 in 1", "5 in 1" etc.

Refer to the manufacturer's packaging as to whether the combi tabs are suitable for the water hardness level in your area. Please note that the cleaning and drying results of tab detergents can vary greatly.

For optimum cleaning and drying results use Miele dishwasher detergent and add Miele salt and Miele rinse aid separately.

Dispensing

- Follow the dosage recommended on the packaging.
- Unless directed otherwise, use one detergent tab or add 20 to 30 ml in compartment II, depending on the level of soiling. With very heavy soiling you can also add a small amount of detergent to compartment I (see "Programme chart").
- Do not use tabs with the **Quick wash** programme, as they will not dissolve properly.

Failure to dispense the recommended amount of detergent may impair cleaning results.

 Avoid inhalation of powder detergents and do not ingest dishwasher detergent. Dishwasher detergents contain irritant or corrosive ingredients which can cause burning in the nose, mouth and throat if swallowed, or inhibit breathing. Consult a doctor immediately if detergent has been swallowed or inhaled.

Keep detergent and other household agents out of the reach of children at all times. Keep children away from the dishwasher when the door is open. There could still be detergent residues in the cabinet. To avoid the danger of children coming into contact with the dishwasher detergent, only add detergent just before starting the programme and close the door, activating the child safety lock (if your dishwasher is fitted with one).

The flap is always open at the end of a programme.

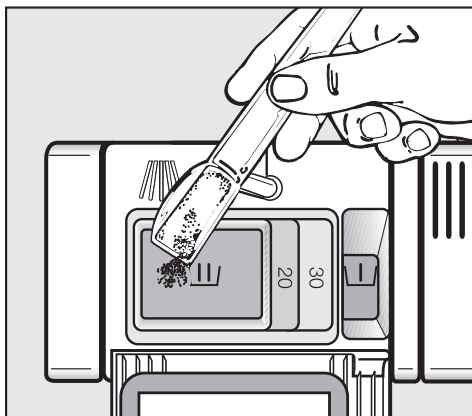

- Add the required amount of detergent and close the flap.
- Make sure that the detergent packaging is properly closed after use to avoid it getting damp and becoming lumpy.

Adding detergent

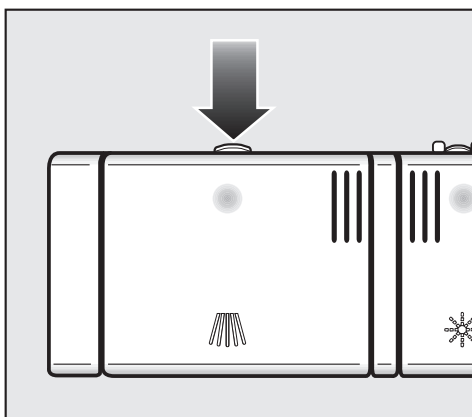

- Press the opening catch on the detergent dispenser. The flap will spring open.

For information

Compartment I holds max. 10 ml,
Compartment II holds max. 50 ml.

There are markings in compartment II to assist with dispensing: 20, 30. The marks indicate a level of approx. 20 or 30 ml when the door is open in a horizontal position.

Operation

Switching on

- Make sure the spray arms are not obstructed.
- Close the door.
- Open the stopcock, if it is closed.
- Switch the dishwasher on using the  sensor.

The main menu will appear in the display.

If the memory function is activated, the programme menu for the programme last selected will be displayed instead (see Settings menu , Memory).

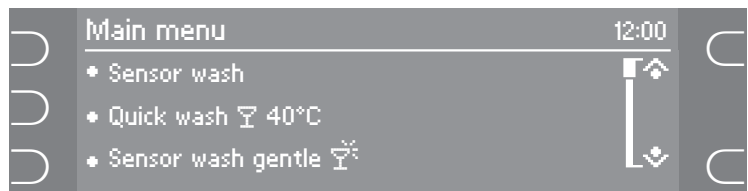

Select programme

Choose your programme according to the type of load and how dirty it is.

The different programmes and their uses are described in the **Programme chart** later on in this booklet.

- Select the programme you want.

The display will change to show the programme menu.



Touch the **i** sensor to call up more information about the programme currently selected.

To select a different programme, touch the Clear sensor <C to return to the main menu.

Selecting Extra options

You can now select Extra options for your chosen programme.

- To do this, first select the **Extras** option in the menu.

The Extras available for your programme will appear in the display.

The following extras are available:

Turbo:

- For shortening the programme duration.
In order to achieve optimum results, consumption rates increase with this option.
When used together with the **Quick wash** programme, the **Turbo** function operates a cycle without heating to rinse crockery if a complete programme is not yet needed.

Pre-wash:

- For rinsing crockery to avoid smells if a complete cycle is not yet needed.

Soak:

- For loosening very stubborn food residues from pots, pans and casserole dishes.
If you are using powder dishwasher detergent, add approx. 5 g to compartment I.

Longer drying:

- For improved drying of awkwardly shaped dishes and also plastic items.

- Select the Extra options you want.

A tick ✓ will appear beside the Extra to show that it has been set.

- To cancel the selection of an Extra, touch the appropriate sensor again.

- When you have finished selecting Extras, confirm with **OK**.

The display will change back to the programme menu.

The message **Extras selected** will appear in the display.

You can specify the type of dishwasher detergent you use. You can choose normal detergent, 2 in 1 tabs or Combination tabs (see Settings menu **F**, Detergent type).

Operation

Starting a programme

- Select the **Start** option.

The programme starts, and the prompt **Add an item** shows in the display. As long as this prompt is showing, crockery can be added without compromising the wash results.

A programme can only be cancelled in the first few minutes. Otherwise the programme must continue to the end so that important programme stages (e.g. reactivating the water softener) are not omitted.

Display

The duration of the programme selected appears in hours and minutes in the display before the programme begins. During the programme, the time left until the end of the programme is displayed.

The time displayed may vary with the same programme. This could be due to the water temperature at each intake, the reactivation cycle, the amount of crockery and how dirty it is.

When a programme is selected for the first time, the display shows an average time for a cold water intake.

The times shown in the Programme chart refer to standard test loads and temperatures.

Each time a programme is run, the electronic unit adjusts the programme duration according to the temperature of the incoming water and the amount of crockery.

To save energy, the time display goes out after a few minutes if you do not touch any sensors during this time. Touch any sensor (apart from the On/Off sensor ①) to switch the time display back on again.

At the end of a programme

If the message **Programme finished** or **Drying plus** comes up in the display, and the door has opened slightly, this indicates that the programme has finished.

You can now empty the dishwasher.

 If you have deselected the automatic door opening function (see Settings menu, Drying plus), but would still like to open the door at the end of the programme, then make sure that you open the door fully. Otherwise steam from the dishwasher could damage the edge of the worktop because the fan is no longer running.

Switching off

At the end of a programme:

- Switch the dishwasher off using the On/Off sensor .

The dishwasher will continue to use electricity until it is switched off with the  sensor.

If the dishwasher is not going to be used for a longer period of time, e. g. whilst on holiday, the stopcock should be turned off.

Unloading the dishwasher

Dishes tend to break and chip more easily when they are hot. Allow the dishes to cool until they are comfortable enough to handle before unloading them.

If you open the door fully after switching off, the dishes will cool much faster.

First unload the lower basket, then the upper basket and finally the cutlery tray (depending on model). This will prevent water drops from the upper basket and cutlery tray from falling onto the dishes in the lower basket.

Interrupting a programme

A programme is interrupted as soon as the door is opened.

If the door is closed again, the programme will continue from the point it was at before the door was opened.

 Water in the dishwasher may be hot. Danger of scalding. Only open the door if absolutely necessary and exercise extreme caution when doing so. Before closing the door again, leave it ajar for approx. 20 seconds. This will enable the temperature in the wash cabinet to settle. Then push the door shut until the catch engages.

Operation

Changing a programme

Important:

If the detergent dispenser flap has already opened, do not change the programme.

If a programme has already started and you wish to change it, proceed as follows:

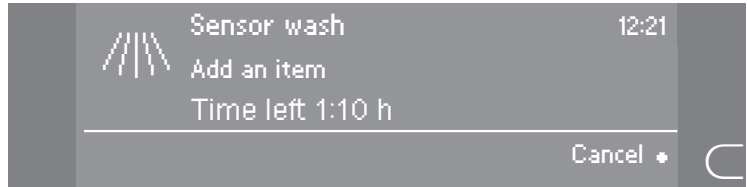

- Select **Cancel**.
- Confirm **Cancel programme?** with **OK**.

The programme will be cancelled.

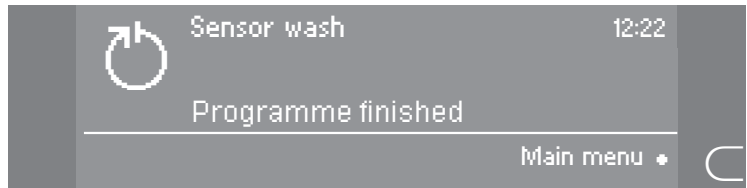

- Select the **Main menu** option.

The display will revert to the main menu.

- Select the programme you want, and then start it.

Delay start

The start time of a programme can be delayed, e.g. to benefit from economy rates of electricity. A delay start time of between 15 minutes and 24 hours can be selected. The delay start time is set in 15 minute steps.

When using the Delay start function, make sure that the detergent compartment is dry before adding detergent. Wipe dry with a cloth if necessary. If the compartment is wet, powder detergent can become lumpy and stick to the dispenser, with the result that it is not fully dispensed. Do not use liquid detergent when selecting Delay start, as it can run into the dishwasher before it is required.

- Switch the dishwasher on using the ⓪ sensor.
- Select the programme you want from the main menu.
- Select the **Start time** option from the programme menu.

The last start time selected will appear in the display.

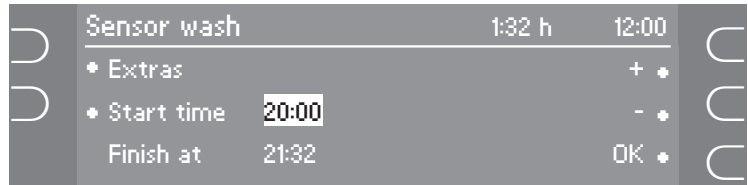

- Use +/– to select the time you want the programme to start at.
If you continue to touch the sensor, the time will automatically decrease or increase.

The end time alters automatically.

Additional functions

- Confirm the start time with **OK**.
- Select the **Start** option.

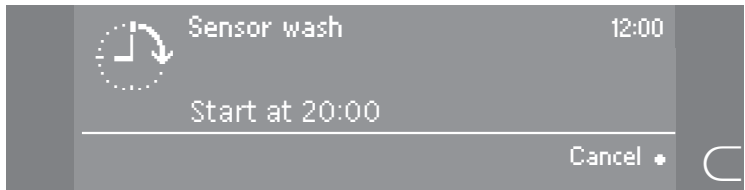

The programme name and the start time will appear in the display.

When the set time is reached, the programme selected will begin automatically.

 To prevent children coming into contact with dishwasher detergent, do not fill the detergent dispenser **until just before starting the programme**, i.e. before selecting **Start**, and activate the child safety lock.

Starting a programme before the Delay start period has elapsed:

A programme can be started before the Delay start period has elapsed. Proceed as follows:

- Select **Cancel** and confirm with **OK**.
- Select the **Main menu** option.

The display will revert to the main menu.

- You can now select and start a programme.

Check your dishwasher regularly (approx. every 4 - 6 months). This way faults and problems can be avoided.

Miele branded cleaning and conditioning products are available from the Miele Spare Parts Department or via the Internet at www.miele-shop.com.

 The external surfaces of the dishwasher are susceptible to scratching. Contact with unsuitable cleaning agents can alter or discolour the outer surfaces.

Cleaning the wash cabinet

The wash cabinet is largely self-cleaning, provided that the correct amount of detergent is always used.

If, however, there are limescale or grease deposits in the cabinet, these can be removed with a proprietary dishwasher cleaner or conditioner.

Cleaning the door and the door seal

■ Wipe the door seals regularly with a damp cloth to remove food deposits.

- When the dishwasher is being loaded, food and drink residues may drip onto the sides of the dishwasher door. These surfaces are outside the wash cabinet and are not accessed by water from the spray arms. Any soiling should be wiped off these surfaces before the door is closed.

Cleaning the door front

 Remove any soiling immediately. If not, it might become impossible to remove and could cause the outer surface to alter or discolour.

- Clean the front using a damp Miele microfibre E-cloth or with a sponge and a solution of hot water and washing-up liquid. Then dry with a soft cloth.

To avoid damaging the external surfaces, do not use:

- cleaning agents containing soda, ammonia, acids or chlorides,
- cleaning agents containing descaling agents,
- abrasive cleaning agents, e.g. powder cleaners and cream cleaners.
- solvent-based cleaning agents,
- stainless steel cleaning agents,
- dishwasher cleaner,
- oven sprays,
- glass cleaning agents,
- hard, abrasive sponges and brushes, e.g. pot scourers,
- sharp metal scrapers.

Cleaning and care

Checking the filters in the wash cabinet

The filter combination in the base of the wash cabinet retains coarse soil from the suds solution, preventing it accessing the circulation system and re-entering the cabinet through the spray arms.

 This dishwasher must not be used without all the filters in place.

Collection of coarse soil may cause the filters to clog. The level of soiling and time it takes before the filters need cleaning will vary depending on use.

The message **Check filters** will appear in the display after every 40 programme cycles (factory default setting).

You can set the interval for this message to appear to between 30 and 60 programme cycles (see "Settings menu , Check filters").

- Check the filter combination.
- Clean it, if necessary.
- Then confirm the message with **OK**.

The display will change to show the programme selection menu.

Cleaning the filters

- Switch the dishwasher off.

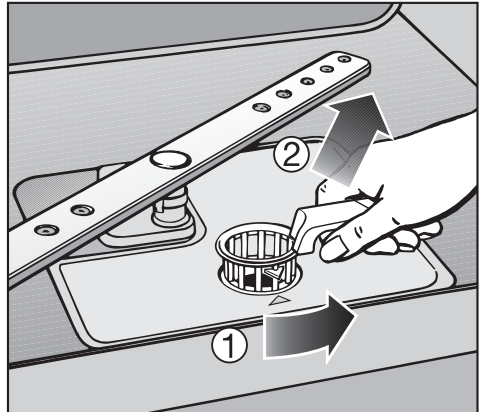

- Turn the handle anti-clockwise to release the filter combination ①.
- Lift the filter combination out of the dishwasher ②. Remove any coarse particles and rinse the filter well under running water. Use a nylon brush if necessary.

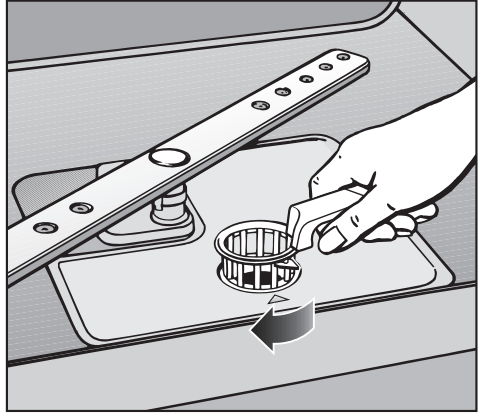
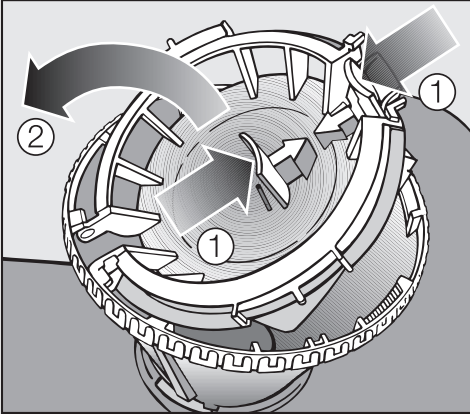

To clean the inside of the filter, the flap must be opened:

- Press catches ① together in the direction of the arrows as shown, and open the filter ②.
- Rinse all the filters under running water.
- Then close the flap so that the catch engages.

- Replace the filter combination so that it lies flat in the base of the wash cabinet.
- Then turn the handle clockwise, until the arrows line up, to lock the filter combination in place.

 Take care when you are fitting the filter combination that it is secured in position correctly. Otherwise coarse soil could get into the circulation system and cause a blockage.

Cleaning and care

Cleaning the spray arms

Particles of food can get stuck in the spray arm jets and bearings. The spray arms should therefore be inspected and cleaned regularly (approx. every 4 - 6 months).

- Switch the dishwasher off.

Remove the spray arms as follows:

- Take out the cutlery tray (if your dishwasher is fitted with one).
- Push the **top** spray arm upwards to engage the inner ratchet. Then unscrew the spray arm.

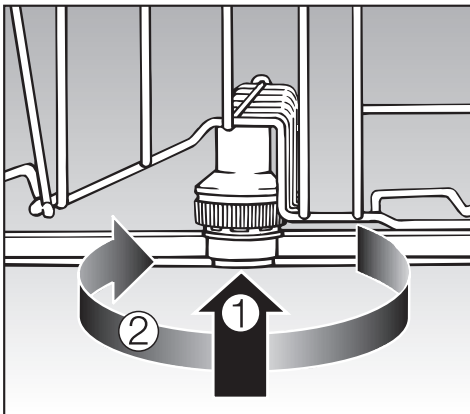

- Push the **middle** spray arms upwards ① to engage the ratchet. Then unscrew the spray arm ②.

- Remove the lower basket.

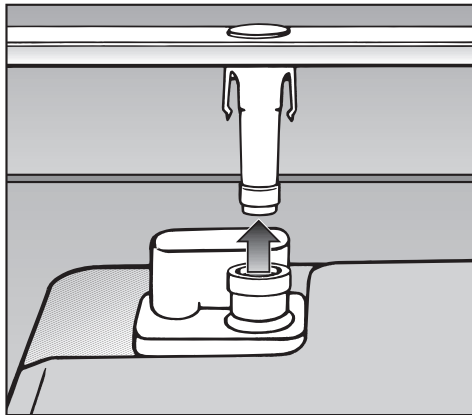

- Pull the **lower** spray arm firmly upwards to remove it.

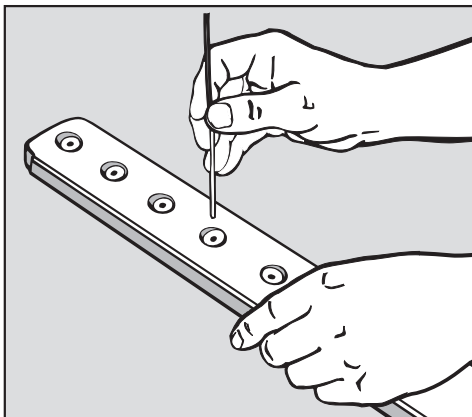

- Use a pointed object to push food particles into the spray arm jets.
- Rinse thoroughly under running water.
- Replace the spray arms and check that they rotate freely.

Problem solving guide

With the aid of the following guide, faults in the performance of the appliance, some of which may result from incorrect operation can be put right without contacting the Service Department.

The following guide may help you to find the reason for a fault, and to correct it. You should, however, note the following:

 Repairs should only be carried out by a suitably qualified and trained person in strict accordance with current local and national safety regulations. Unauthorised or incorrect repairs could cause personal injury or damage to the appliance.

Technical problems		
Problem	Possible cause	Remedy
The display remains dark and the Standby indicator light is not flashing after the dishwasher has been switched on with the On/Off sensor ①.	The appliance is not plugged in.	Insert the plug and switch on at the socket.
	The fuse has tripped.	Reset or replace the fuse. (Minimum fuse rating - see data plate).
The dishwasher stops during a programme.	The fuse has tripped.	Reset or replace the fuse. (Minimum fuse rating - see data plate).

Problem solving guide

Problem	Possible cause	Remedy
The buzzer sounds. The following fault message appears in the display:		Before rectifying the problem: <ul style="list-style-type: none"> – Switch the dishwasher off using the On/Off sensor ①.
Technical fault FXX Call Service	There may be a technical fault.	<ul style="list-style-type: none"> – First, clean the water inlet filter and clean the drain pump and non-return valve as described in "Maintenance". – Switch the dishwasher back on. – Select the programme you want. – Select Start. If the fault message appears again, there is a technical fault. Call the Service Department.
Waterproof fault F70	The Waterproof system has reacted.	<ul style="list-style-type: none"> – Close the stopcock. – Call the Service Department.
Fault with auto. door closing	The door is sometimes obstructed by an item inside the appliance.	<ul style="list-style-type: none"> – If this is the case, remove the item and switch the dishwasher on again. – If the same message appears again, call the Service Department.
Fault with auto. door opening	There may be a technical fault.	<ul style="list-style-type: none"> – Open the door manually, and switch the dishwasher on again. – If the same message appears again, call the Service Department.

Problem solving guide

The dishwasher does not fill/drain.		
Problem	Possible cause	Remedy
The buzzer sounds. The following fault message appears in the display:		
Water inlet fault Please open the stopcock.	The stopcock is closed.	Open the stopcock fully.
Water inlet fault FXX		Before rectifying the problem, you must: <ul style="list-style-type: none"> – Switch the dishwasher off using the On/Off sensor ①.
	Fault F12/F13: Water intake is restricted.	<ul style="list-style-type: none"> – Open the stopcock fully and start the programme again. – Clean the water inlet filter (see "Maintenance"). – The water pressure at the intake is lower than 30 kPa (0.3 bar). Seek professional advice.

Problem solving guide

Problem	Possible cause	Remedy
<p>In the display for the Without heater programme, the following fault message appears: Water intake temp. too low</p>	<p>The intake water has not reached the required temperature of 45 °C (see Connection to the water supply).</p>	<ul style="list-style-type: none"> – Start the programme again. – If the fault message appears again, select a different programme.
<p>The buzzer sounds. The following fault message appears in the display: Drain fault F11</p>	<p>Water outlet is restricted, water remains in the wash cabinet at the end of a programme.</p>	<p>Before rectifying the problem:</p> <ul style="list-style-type: none"> – Switch the dishwasher off using the On/Off sensor ①. – Clean the filter combination. See "Cleaning and care". – Clean the drain pump. See "Maintenance". – Clean the non-return valve. See "Maintenance". – Remove any kink in the drain hose.

Problem solving guide

General problems		
Problem	Possible cause	Remedy
The display is dark.	The display has switched off automatically to save energy (Standby mode).	Touch any sensor. Standby comes to an end.
The buzzer sounds during a programme. The following fault message appears in the display: Salt reservoir cover Close the salt reservoir	The salt reservoir has not been closed properly.	<ul style="list-style-type: none"> – Close the flap to the salt reservoir properly. If the salt reservoir flap has come undone during a programme, you must: <ul style="list-style-type: none"> – Switch the dishwasher off and then back on again with the On/Off sensor ①. – Start the programme again.
The following fault message appears in the display: Middle spray arm blocked or Bottom spray arm blocked	<p>Items are blocking the path of the middle or the bottom spray arm.</p> <p>The middle or bottom spray arm jets are blocked.</p>	<p>Open the dishwasher door and rearrange the items which are obstructing the spray arm.</p> <ul style="list-style-type: none"> – Switch the dishwasher off using the On/Off sensor ①. Then: <ul style="list-style-type: none"> – Clean the spray arm. See Cleaning and care.



Problem solving guide

Problem	Possible cause	Remedy
Detergent residue is left in the dispenser at the end of a programme.	The dispenser was still damp when detergent was added.	Make sure the dispenser is dry before adding detergent.
The detergent dispenser lid cannot be closed properly.	Clogged detergent residue is blocking the catch.	Clean the detergent from the catch.
At the end of a programme there is a film of moisture on the inside of the door and the interior walls.	This is caused by the drying system and does not indicate a fault.	The moisture will dissipate after a short while.
Water remains in the wash cabinet at the end of a programme.		Before rectifying the problem: – Switch the dishwasher off using the On/Off sensor ①.
	The filter combination in the wash cabinet is clogged.	Clean the filter combination. See "Cleaning and care".
	The drain pump or non-return valve may be blocked.	Clean the drain pump or the non-return valve. See "Maintenance".
	The drain hose is kinked.	Remove any kink from the drain hose.



Problem solving guide

Noises		
Problem	Possible cause	Remedy
Knocking noise in the wash cabinet.	A spray arm is knocking against an item in a basket.	Interrupt the programme, and rearrange the items which are obstructing the spray arm.
Rattling noise in the wash cabinet.	Items of crockery are insecure in the wash cabinet.	Interrupt the programme, and rearrange the items of crockery.
Knocking noise in the water pipes.	This may be caused by the on-site installation or the cross-section of the piping.	This has no influence on dishwasher function. If in doubt, contact a suitably qualified plumber.

Problem solving guide

Unsatisfactory washing result		
Problem	Possible cause	Remedy
The dishes are not clean.	The dishes were not loaded correctly.	See notes in "Loading the dishwasher"
	The programme was not powerful enough.	Select a more intensive programme. See Programme chart.
	There is some stubborn soiling although most of the crockery is only lightly soiled (e.g. with tea stains).	Use the Adjust Sensor wash setting (see "Settings menu  , Adjust Sensor wash").
	Not enough detergent was dispensed.	Use more detergent, or change your detergent.
	Items are blocking the path of the spray arms.	Rearrange the items so that the spray arms can rotate freely.
	The filter combination in the base of the wash cabinet is not clean or is not correctly fitted. This may cause the spray arm jets to get blocked.	Clean and/or fit the filter combination correctly. Clean the spray arm jets. See Cleaning and care.
	The non-return valve is open and blocked. Dirty water has flowed back into the wash cabinet.	Clean the drain pump and the non-return valve. See "Maintenance - Cleaning the drain pump and non-return valve".
Smearing appears on glassware and cutlery, there is a bluish sheen on the surface of glassware; film can be wiped off.	The rinse aid dosage is set too high.	Reduce the dosage (see "Settings menu  , Rinse aid").

Problem solving guide

Problem	Possible cause	Remedy
Dishes, cutlery and glasses are not dry or are flecked.	The amount of rinse aid may be insufficient, or the rinse aid reservoir empty.	Replenish the reservoir, increase the dosage or change the brand of rinse aid. See "Before using for the first time".
	Crockery was taken out of the cabinet too soon.	Leave it in for longer. See Operation.
	Combi tabs have been used which have impaired drying performance.	Set the Detergent type to Normal, and fill the rinse aid reservoir with rinse aid. (See "Settings menu  , Detergent type".)
	The dishwasher has been set for 2 in 1 or Combi tabs, even though this type of detergent has not been used.	Set the Detergent type for the product being used. (see "Settings menu  , Detergent type".)
White residue is visible on cutlery and crockery, clouding occurs on glassware; film can be wiped off.	Not enough rinse aid was used.	Reduce the dosage (see "Settings menu  , Rinse aid").
	There is no salt in the salt reservoir.	Fill the salt reservoir. See "Before using for the first time - Filling the salt reservoir".
	An unsuitable combination detergent has been used.	Change your detergent. Use a standard liquid, tablet or powder detergent.
	There is a fault with the automatic water softening system.	Call the Service Department.

Problem solving guide

Problem	Possible cause	Remedy
Glassware has a brown or blue tinge, and film cannot be wiped off.	This may be caused by the detergent.	Change your detergent.
Glassware is dull and discoloured; film cannot be wiped off.	The glassware is not dishwasher-proof. The surfaces are affected.	There is no remedy. Purchase glassware which is dishwasher-proof.
Tea or lipstick stains have not been completely removed.	The wash temperature of the selected programme was too low.	Select a programme with a higher wash temperature.
	The bleaching effect of the detergent used is too low.	Change your detergent.
Plastic items are discoloured.	Natural dyes e.g. from carrots, tomatoes or ketchup may be the cause. The amount of detergent used or its bleaching effect was not sufficient to deal with natural dyes.	Use more detergent. See "Operation". Discolouration is irreversible.
There are rust stains on cutlery.	The affected items are not corrosion resistant.	There is no remedy. Purchase cutlery which is dishwasher-proof.
	A programme was not run after dishwasher salt was added. Traces of salt have got into the wash cycle.	Always run the "Quick wash" programme, without any crockery in the dishwasher and without selecting the "Turbo" function, after adding dishwasher salt.

Cleaning the water inlet filter

A filter is incorporated in the screw connection of the valve on the water inlet hose. The filter must be cleaned when dirty, otherwise insufficient water flows into the wash cabinet.

 The plastic housing of the water connection contains an electrical component. It must not be dipped in water.

Recommendation

If the mains water contains a large amount of insoluble substances, we recommend fitting a large-area filter in the connection between the stopcock and the water inlet hose threaded union. This filter is available from the Miele Spares Parts dept.

Cleaning the filter:

- Disconnect the dishwasher from the mains supply. Switch off at the mains socket and withdraw the plug.
- Close the stopcock.
- Unscrew the inlet hose.

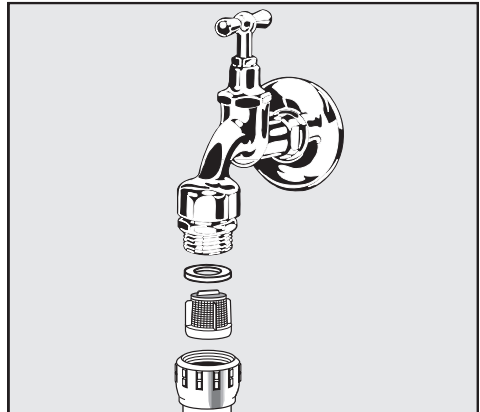

- Carefully remove the seal.
- Withdraw the filter using pointed pliers and rinse clean under running water.
- Replace the filter and seal, making sure they are sitting correctly.
- Reconnect the inlet hose to the stopcock, making sure it goes on correctly and is not cross-threaded.
- Turn on the stopcock gradually to test for leaks. If there is a leak, the inlet hose might not be on securely, or it may have been screwed on at an angle. Unscrew and reconnect the water inlet valve correctly.

Maintenance

Cleaning the drain pump and non-return valve

If the water has not been pumped away at the end of a programme the drain pump or the non-return valve might be blocked. They are, however, easy to clean.

- Disconnect the dishwasher from the mains supply. Switch off at the mains socket and withdraw the plug.
- Take the filter combination out of the wash cabinet (see "Cleaning and care - Cleaning the filters in the wash cabinet").
- Scoop the water out of the cabinet using a suitable container or utensil.

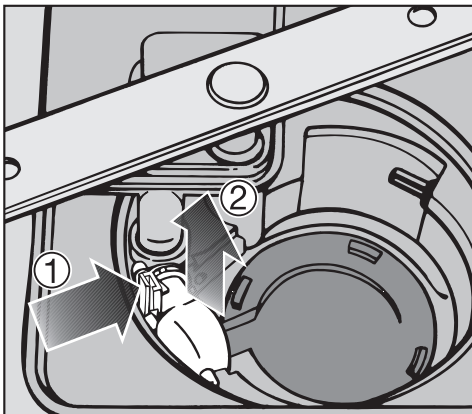

- Press the catch for the non-return valve inwards ①.
- Lift out the non-return valve ②, and rinse well under running water.
- Remove all foreign objects from the non-return valve.

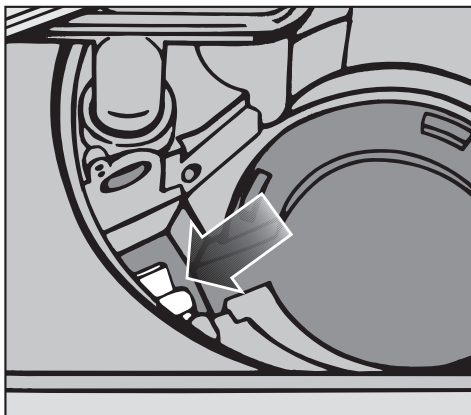

The drain pump is situated under the non-return valve (see arrow).

- Remove all foreign objects from the drain pump (watch out for glass or bone splinters which are particularly difficult to detect and could cause injury). Turn the drain pump impeller by hand to check that there are no more obstructions. You will feel a little resistance when you turn the impeller.
- Carefully replace the non-return valve and secure it with the catch.

 Ensure that the catch engages correctly.

Repairs

In the event of any faults that you cannot remedy yourself, please contact:

- Your Miele dealer, or
- the Miele Service Department (see back cover for address).

Please note that telephone calls may be monitored and recorded to improve our service.

- When contacting your Dealer or the Service Department, please quote the model type and number of your appliance, both of which are shown on the data plate on the right hand side of the door.

N.B. A call-out charge will be applied for service visits where the problem could have been rectified as described in these instructions.

Future updates

The programme update function is designed to enable a service technician to update your appliance's electronics in keeping with advances in technology.

Information regarding programme updates will be made known by the Miele Company as and when such developments become available.

For testing institutes

All information required regarding comparison testing and measuring noise levels is given in the "**Comparison tests**" leaflet.

The latest version of this leaflet can be ordered on-line from:

- testinfo@miele.de





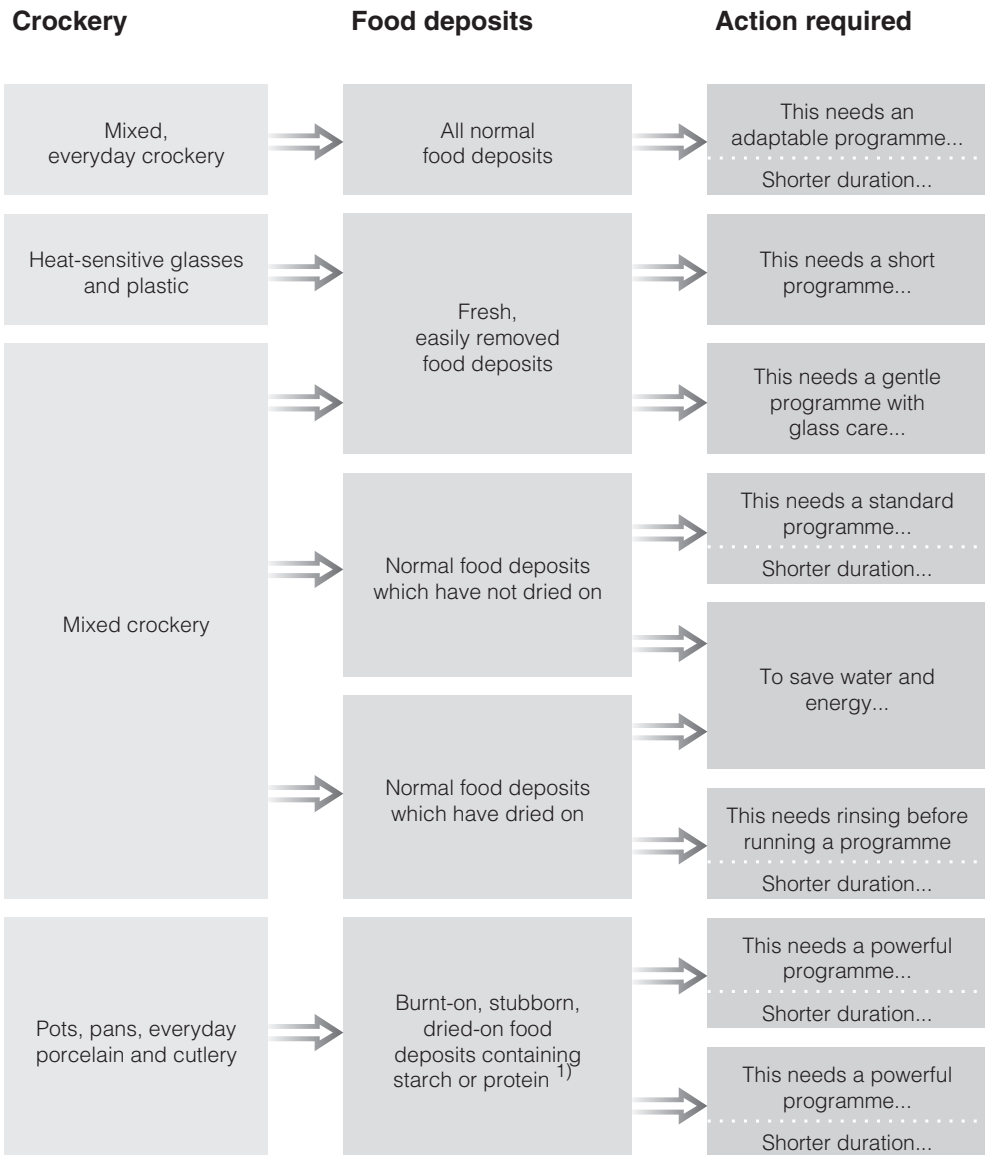



- Please give your postal address, as well as the model type and number of your dishwasher (see data plate).

Programme chart



¹⁾ Food such as potatoes, pasta, rice or casseroles can leave starchy deposits. Deposits containing protein can be left by food such as fried meat, fish or eggs and bakes.

Programme chart

Programme	Detergent	
	Compartment I ²⁾	Compartment II ²⁾
 Sensor wash + Turbo option	-	25 ml or 1 tab
 Quick wash 40°C	-	20 ml or 1 tab ³⁾
 Sensor wash gentle	-	20 ml or 1 tab
 Light soiling 50°C + Turbo option	-	25 ml or 1 tab
 Energy save	-	25 ml or 1 tab
 Normal 55°C + Turbo option	-	25 ml or 1 tab
 Intensive 65°C + Turbo option	-	25 ml or 1 tab
 Pots & pans 75°C + Turbo option	10 ml	25 ml or 1 tab

²⁾ see "Detergent"

³⁾ In some cases, tabs may not dissolve completely.

Programme chart

Programme	Programme sequence					
	Pre-wash	Main wash °C	Interim rinse		Final rinse °C	Drying
			1	2		
Sensor wash	Variable programme sequence, sensor controlled adjustment according to the amount of crockery and level of food deposits					
	If required	45-65	If required		65	X
Quick wash 40 °C		40	X		45	X
Sensor wash gentle 45 °C	Variable programme sequence with glass care, sensor controlled adjustment according to the amount of crockery and level of food deposits					
	If required	40-48	If required		55	X
Energy save		45	X		60	X
Light soiling 50 °C		50	X		65	X
Normal 55 °C	X	55	X		65	X
Intensive 65 °C	X	65	X		65	X
Pots & pans 75 °C	X	75	X		65	X

Programme chart





Consumption ¹⁾			Duration ¹⁾	
Energy		Water	Cold water connection (15 °C) h:min	Hot water connection (55 °C) h:min
Cold water connection (15 °C) kWh	Hot water connection (55 °C) kWh	Litres		
0.95-1.35	0.70-1.00	8-17	1:30-2:38	1:18-2:21
0.55	0.20	10	0:38	0:27
0.70-0.95	0.40-0.50	10-17	1:26-2:02	1:17-1:43
1.05	0.70	10	2:49	2:40
1.05	0.75	10	1:36	1:23
1.15	0.80	13	2:09	1:58
1.25	0.95	13	2:19	2:06
1.50	1.10	14	2:38	2:27

1) Values quoted are in accordance with EN 50242. The durations given will vary depending on individual conditions and the effect the sensors have on the load.

When the Combi tabs function is selected, energy consumption may increase by up to 0.2 kWh, and the programme duration by up to 15 minutes.

On G 2XXX models (see data plate), the max. energy consumption is 0.1 kWh higher and the water consumption is up to 1 litre higher than shown above.

Programme chart

Programme	When to use
Hygiene	Programme with special parameters for hygienic removal of bacteria from baby bottles, chopping boards, utensils etc.
Pre-wash	For rinsing crockery to avoid smells, if a complete cycle is not yet needed.
Without heater 	Only for use with hot water connection of at least 45°C/115°F; for lightly to normally soiled crockery; includes sensor controlled glass care system.
Pasta	For removing dried on pasta/paella residues; use 20% more detergent than recommended for a full load.
Plastics 	For gentle cleaning of dishwasher-proof plastic items; includes sensor controlled glass care system.
Tall items 65 °C	For very large heat-resistant items , e.g. tall vases.
Glasses warm 	For cleaning glassware without rinse aid and without detergent; includes sensor controlled glass care system.
Glasses quick 	For rapid cleaning of glasses for immediate re-use; without rinse aid or detergent; includes sensor controlled glass care system.

Programme chart

Programme sequence					Consumption ¹⁾			Duration ¹⁾	
					Energy		Water		
Pre-rinse	Main wash °C	Interim rinse 1 2	Final rinse °C	Drying	Cold water connection (15 °C) kWh	Hot water connection (55 °C) kWh	Litres	Cold water connection (15 °C) h:min	Hot water connection (55 °C) h:min
	70	X	70	X	1.35	1.05	13	2:14	2:05
X					0.01	0.01	4	0:13	0:13
2X	X	X	X	X		0.05	26		1:26
X	75	X	65	X	1.40	1.15	13	2:29	2:16
X	45	X	65	X	0.85	0.60	13	2:07	1:55
X	65	X	65	X	1.00	0.65	13	1:52	1:39
	35	X	55	X	0.50	0.30	10	0:49	0:41
	25	X	X		0.20		10	0:17	

1) Values quoted are in accordance with EN 50242. The durations given will vary depending on individual conditions and the effect the sensors have on the load.

When the Combi tabs function is selected, energy consumption may increase by up to 0.2 kWh, and the programme duration by up to 15 minutes.

On G 2XXX models (see data plate), the max. energy consumption is 0.1 kWh higher and the water consumption is up to 1 litre higher than shown above.

Optional accessories

To make the most of your dishwasher

Optional accessories for particular purposes are available from your Miele dealer, the Spare Parts Department or online at www.miele-shop.com (some may be supplied as standard, depending on model).

If you would like to ...	you will need to order ...
... wash long-stemmed glassware	... a glassware insert for the upper basket
... wash a Miele Cappuccinatore	... a Cappuccinatore insert for the upper basket
... small plates, baby bottles and small items in the upper basket	... a multi-function basket for the upper basket
... different sized plates, cups and glasses in the upper basket	... a vario insert for the upper basket
... wash bottles, e. g. milk or baby bottles	... a bottle holder
... wash additional items of cutlery	... a small cutlery basket for the lower basket
... wash a lot of glasses	... a glassware insert for the lower basket
... wash large plates	... an insert for plates up to: - 33 cm diameter - 35 cm diameter
... monitor the dishwasher	... the Miele@home communication module and the Miele@home InfoControl.

Electrical connection U.K.

 All electrical work must be carried out by a suitably qualified and competent person, in accordance with current local and national safety regulations (BS 7671 in the UK).

Ensure power is not supplied to the appliance until after installation work has been carried out.

The appliance is supplied with a mains cable with moulded plug ready for connection to a 230-240V mains supply. Please ensure the connection data quoted on the data plate match the household mains supply.

Connection should be made via a suitable switched socket which is easily accessible after installation.

For extra safety it is advisable to install a suitable residual current device (RCD). Contact a qualified electrician for advice.

Do not connect via an extension lead. Extension leads do not guarantee the required safety of the appliance (e.g. danger of overheating).

Non-rewireable plugs BS 1363

The fuse cover must be refitted when changing the fuse, and if the fuse cover is lost, the plug must not be used until a suitable replacement is obtained. The colour of the correct replacement cover is that of the coloured insert in the base of the plug, or the colour that is embossed in words on the base of the plug (as applicable to the design of plug fitted).

Replacement fuses should be ASTA approved to BS 1362 and have the correct rating. Replacement fuses and fuse covers may be purchased from your local electrical supplier.

**WARNING: THIS APPLIANCE
MUST BE EARTHED**

Plumbing

The Miele waterproof anti-leak system

Providing your dishwasher has been installed correctly, the Miele waterproof anti-leak system will protect you from water damage throughout its lifetime.

Connection to the water supply

 Water in the dishwasher must not be used as drinking water.

- The dishwasher may be connected to a cold or hot water supply, max. 60 °C. We would only recommend connection to a hot water supply if it is economical, e.g. a solar powered supply. When connected to a hot water supply all programme stages which would otherwise be carried out with cold water will be carried out with hot water.
- The Without heater programme (if available) requires a hot water supply of between 45 °C (minimum) and 60 °C (maximum). The higher the water intake temperature, the better the cleaning and drying results.
- The inlet hose is approx. 1.5 m long. A 1.5 metre long flexible metal extension hose, pressure tested to 14,000 kPa/ 140 bar, is available as an optional accessory if required.
- A stopcock with a $\frac{3}{4}$ " male thread must be provided on site.

- This appliance is constructed to comply with IEC/EN/DIN 61770 // VDE 0700 Section 600, and may be connected to a suitable supply without an extra non-return valve if national regulations permit.
- The water pressure (flow pressure at the take-off point) must be between 30 and 1000 kPa (0.3 and 10 bar). If the water pressure is lower than this, the fault message **Water inlet fault** will appear in the display (see Problem solving guide). If the water pressure is too high, a pressure reducer valve must be fitted.

 To avoid any damage to the appliance, the dishwasher must only be connected to a fully vented plumbing system.

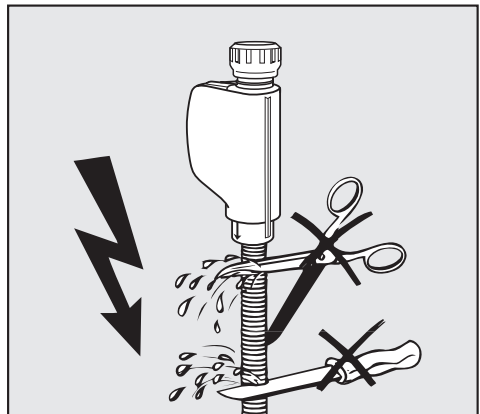

 The inlet hose must **not** be shortened or damaged in any way as it contains electrical components (see illustration).

Drainage

- The appliance drainage system is fitted with a non-return valve, which prevents dirty water from flowing back into the dishwasher via the drain hose.
- The dishwasher is supplied with approx. 1.5 m of flexible drain hose with an internal diameter of 22 mm.
- The drain hose can be extended using a connection piece to attach a further length of hose. The drainage length must not be longer than 4 m, and the delivery head must not exceed 1 m.
- If the hose is to be directly fitted to the drainage outlet on site, use the hose clip supplied (see installation diagram).
- The hose can be directed to the left or the right of the appliance.
- The on-site connector for the drain hose can be adapted to different widths of hose. If the connector protrudes too far into the drain hose, it will need to be shortened. Otherwise the drain hose may become blocked.
- The drain hose must not be shortened.

 Make sure that there are no kinks in the hose, and that it is not squashed or stretched.

Venting the drainage system

If the on-site drain connection is situated lower than the guide path for the bottom basket rollers in the open door, the drainage system must be vented. Otherwise a siphoning effect during a programme can cause the appliance to empty itself of water.

To vent it:

- Open the dishwasher door fully.

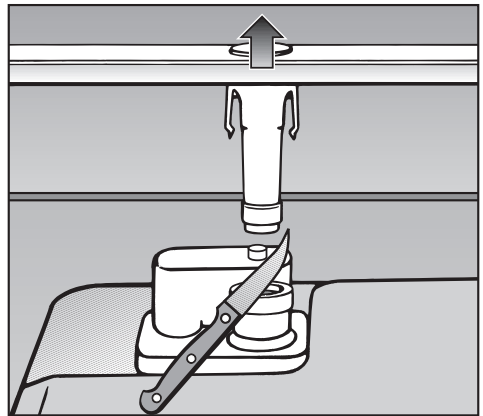

- Pull the lower spray arm firmly upwards to remove it.
- Cut off the top of the vent valve in the wash cabinet.

Technical data

Dishwasher model	G 1XXX	G 2XXX
Height freestanding	84.5 cm (adjustable +3.5 cm)	-
Height built-in	80.5 cm (adjustable + 6.5 cm)	84.5 cm (adjustable + 6.5 cm)
Height of building-in recess	Min. 80.5 cm (+ 6.5 cm)	Min. 84.5 cm (+ 6.5 cm)
Width	59.8 cm	59.8 cm
Width of building-in recess	60 cm	60 cm
Depth:		
Freestanding	60 cm	-
Built-in	57 cm	57 cm
Weight	Max. 66 kg	Max. 58 kg
Voltage	230 V	230 V
Connected load	2200 W	2200 W
Fuse rating	10 A	10 A
Test certificates awarded	KEMA, VDE, radio and television suppressed	KEMA, VDE, radio and television suppressed
Water pressure (flow rate)	30 - 1000 kPa (0.3 - 10 bar)	30 - 1000 kPa (0.3 - 10 bar)
Hot water connection	Up to max. 60 °C	Up to max. 60 °C
Delivery head	Max. 1 m	Max. 1 m
Drainage length	Max. 4 m	Max. 4 m
Mains cable	Approx. 1.7 m	Approx. 1.7 m
Capacity	12/14 place settings*	12/14 place settings*

* depending on model

Settings menu ▸ for changing standard settings

To open the Settings ▸ menu

- Switch the dishwasher on with the On sensor ① if it is switched off.

The main menu will appear in the display.

If the memory function is activated, the programme menu for the programme last selected will be displayed instead (see "Memory"). If this is the case, press the Clear sensor <C to switch to the main menu.



- Select **Settings ▸**.

The display will change to show the Settings ▸ menu.



- Select the option you want to change.

Touch the **i** sensor to call up more information about the programme currently selected.

Sub-menu options which have already been set will have a tick ✓ beside them.

Settings menu ▸

Language ▸

The display can be set to appear in one of several different languages.

You can change the language for the display via the **Language ▸** sub-menu.

- Select the language you want and confirm this with **OK**.

The flag after the word **Language** acts as a guide if a language which you do not understand has already been set.

If this is the case, keep selecting the menu option which has a flag after it until you reach the **Language ▸** sub-menu.

Time

Select either a 24 hour or 12 hour clock and then set the current time of day.

Display

- Select the **Display** option.
- Select the display you require for the time of day, and confirm this with **OK**.

Clock display

- Select the **Clock display** option.
- Select either the 24 hour or 12 hour option and confirm with **OK**.

Set the time

- Select the **Set the time** option.
- Set the hours with **+/-** and confirm with **OK**.
Then set the minutes.

After you have confirmed the minute entry with **OK** the display will change back to the **Time** menu.

- Touch the <C sensor to return to the **Settings ▸** menu.

Detergent type

For optimum results you can programme your dishwasher via the Detergent type menu for the type of detergent you are using.

The options available are: normal dishwasher detergent, 2 in 1 tabs or Combination tabs.

The programme sequence and duration will be adjusted for the type of detergent selected. Depending on the programme, the duration can be considerably longer.

Normal

When using Normal detergent, you must add salt and rinse aid (see "Filling the salt reservoir" and "Adding rinse aid"). The rinse aid refill reminder is active with this setting.

2 in 1

Select the **2 in 1** function if you are using 2 in 1 tabs (detergent containing rinse aid). The programme sequence will be adjusted, and rinse aid will not be dispensed in the programme. The "Rinse aid low" message is also deactivated.

When using 2 in 1 tabs you must still keep the salt reservoir replenished. See "Filling the salt reservoir".

Combination tabs

Select the **Combination tabs** function if you are using Combi tabs (detergent containing rinse aid and salt substitutes, as well as other components where applicable) e.g. 3 in 1 or 4 in 1 tabs. The programme sequence will be adjusted, and rinse aid will not be dispensed in the programme. The "Rinse aid low" message is also deactivated.

When using Combi tabs, you must still keep the salt reservoir replenished. See "Filling the salt reservoir".

Salt consumption in the water softener is reduced to between $\frac{1}{3}$ and $\frac{1}{4}$ of the normal amount.

Do not select the **Combination tabs** function if:

- using 2 in 1 tabs (detergent with rinse aid)
- your water hardness level is above 3.8 mmol/l or 21°d.
Follow the detergent manufacturer's instructions.

The cleaning and drying performance of these types of detergent can vary enormously.

The appliance is set at the factory for using normal dishwasher detergent.

- Select the detergent type you want and confirm with **OK**.

Settings menu

Drying plus

At the end of programmes with a drying phase, the door will open automatically a little in order to help the drying process.

This function can be deactivated if wished.

- Select the option you want and confirm with **OK**.

Water hardness

Your dishwasher is fitted with a water softener sensor which determines the water hardness level of your local water supply automatically.

After your dishwasher has been through one programme cycle (e.g. Pre-wash), you can call up the water hardness level measured by the water softener sensor via the Water hardness option.

- **OK** will return you to the Settings menu .

°d German scale	mmol/l	°f	Value displayed
1	0.2	2	1
2	0.4	4	2
3	0.5	5	3
4	0.7	7	4
5	0.9	9	5
6	1.1	11	6
7	1.3	13	7
8	1.4	14	8
9	1.6	16	9
10	1.8	18	10
11	2.0	20	11
12	2.2	22	12
13	2.3	23	13
14	2.5	25	14
15	2.7	27	15
16	2.9	29	16
17	3.1	31	17
18	3.2	32	18
19	3.4	34	19
20	3.6	36	20
21	3.8	38	21
22	4.0	40	22
23	4.1	41	23
24	4.3	43	24
25	4.5	45	25
26	4.7	47	26
27	4.9	49	27
28	5.0	50	28
29	5.2	52	29
30	5.4	54	30
31	5.6	56	31
32	5.8	58	32
33	5.9	59	33
34	6.1	61	34
35	6.3	63	35
36	6.5	65	36
37-45	6.7-8.1	67-81	45
46-60	8.3-10.8	83-108	60
61-70	11.0-12.6	110-126	70

External water softener

If your dishwasher is connected to an external water softening system which uses salt to reactivate, to achieve good cleaning results you will still need to set the water hardness level of the water softening unit on the dishwasher to the water hardness level of the water supplied from the external water softening system.

If you do not know what this is, then set the value at 1.4 mmol/l (8 °d - German scale).

- Select the value which equates to the water hardness level of the water supplied by the external water softening unit and confirm your selection with **OK**.

If you disconnect the dishwasher from the external water softening system, select the **Automatic** option.

Rinse aid

You can adjust the rinse aid dosage for best results.

The rinse aid dosage can be set from approx. 0-6 ml.

The factory default setting is 3 ml.

Due to the Adjust sensor wash function, the amount of rinse aid dispensed could be higher than that set in the Sensor wash programme.

If spots appear on crockery and glassware:

- Increase the rinse aid dosage.

If clouding or smearing appears on crockery and glassware:

- Decrease the rinse aid dosage.

- Use **+/-** to select the rinse aid dosage you want and confirm with **OK**.

Check filters

You can adjust the interval at which the message to remind you to check the filters appears.

You can set an interval of between 30 and 60 programme cycles.

The "Check filters" message is set at the factory to appear after every 40 programme cycles.

- Select the interval you want and confirm this with **OK**.

Adjust Sensor wash

You can adjust the Sensor wash programme so that it will remove stubborn soiling in a lightly soiled load.

- Select **On** and confirm with **OK**.

Settings menu ▸

Change main menu

You can change the order of the programmes in the programme selection menu and also enter your favourite programmes into the first three programme places.

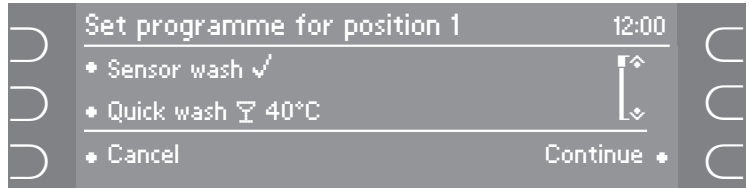

- Select the programme you want to place in the first position of the programme selection menu.
- Confirm with **Continue**.
- Select the programme you want to place in the second position of the programme selection menu.
- Confirm with **Continue**.
- Select the programme you want to place in the third position of the programme selection menu.
- Confirm with **Continue**.

The programmes you have selected will now appear in the order you have chosen.

If you want to change the position of another programme, select **Back** until you reach the relevant menu entry.

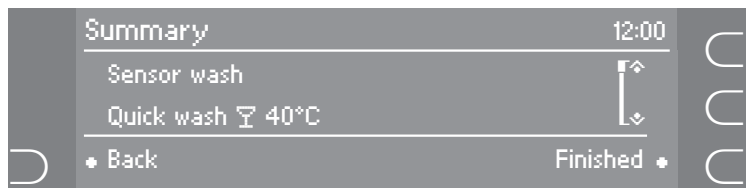

- When you have finished making changes, confirm with **Finished**.

Save extras

You can set additional functions, e.g. Pre-wash, for individual programmes (see "Operation, Selecting Extra options").

You can use the **Save extras** option to save settings you have chosen for a particular programme so that they are automatically selected when you run the programme in the future.

The dishwasher is delivered with this function deactivated.

- Select the option you want and confirm with **OK**.

Settings menu ▸

System lock

The system lock prevents your dishwasher being used without your knowledge.

If an attempt is made to switch the dishwasher on when the system lock is activated **Appliance locked** will appear in the display.

The lock must be cancelled before the dishwasher can be used.

The appliance will lock each time it is switched on while the system lock is activated.

The dishwasher is delivered with the system lock deactivated.

- To activate it, select the **On** option and confirm with **OK**.

To cancel the system lock

To unlock the dishwasher, proceed as follows:

- Switch the dishwasher on using the ① sensor.

The message **Appliance locked** will appear in the display.

- Confirm with **OK**.

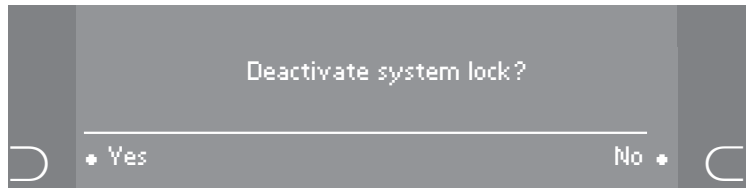

- Select **Yes**.

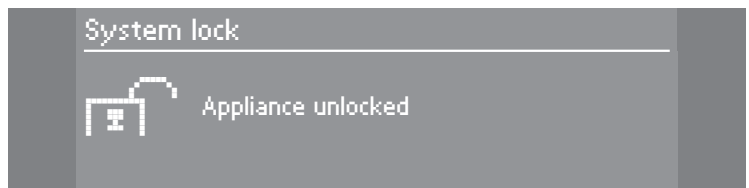

The dishwasher is now unlocked and ready for use.

Temperature

The temperature can be displayed in °C/Celsius or °F/Fahrenheit.

The factory default setting is °C.

- Select the option you want and confirm with **OK**.

Volume

A buzzer sounds at the end of a programme and when the machine has a fault.

- You will hear the buzzer at the end of a programme in bursts of five with a short pause in between.
The buzzer will continue to sound for up to an hour if you do not switch the dishwasher off.

The buzzer at the end of a programme is deactivated as standard at the factory.

- You will hear the buzzer in the case of a fault as a continuous tone for up to two minutes if you do not switch the dishwasher off or correct the fault.

The buzzer which sounds when there is a fault cannot be deactivated.

Buzzer tone

The volume of the buzzer can be selected in seven stages. If no volume is selected, the buzzer is switched off.

The buzzer which sounds when there is a fault cannot be deactivated.

- Select the volume you want or deactivate the buzzer using the **+/-** sensors.
- Confirm with **OK**.

Night time buzzer tone

You can select a different buzzer volume for the night time.

- Select the volume you want or deactivate the buzzer using the **+/-** sensors.
- Confirm with **OK**.

Settings menu ▸

Night time

You can select the times for night time to begin and end.

- Select the **Start at** option in the menu.
- Set the start time for the night using the **+/-** sensors, and confirm with **OK**.
Set the end time for the night using the **+/-** and confirm with **OK**.
- Confirm the times you have set for the night with **OK**.

Keypad tone

An audible tone sounds each time a sensor is touched. The volume of the tone can be selected in seven stages. If no volume is selected, the keypad tone is switched off.

- Select the volume you want or deactivate the keypad tone using the **+/-** sensors.
- Confirm with **OK**.

Brightness

There are seven different display brightness settings.

- Select the brightness you want and confirm this with **OK**.

Contrast

There are seven different display contrast settings.

- Select the contrast you want and confirm with **OK**.

Memory

You can use the Memory function to save the last programme selected.

Instead of the main menu, the last programme selected will appear in the display when the dishwasher is switched off and back on again at the end of a programme or the door is opened and then closed.

The dishwasher is delivered with the Memory function activated.

- Select the option you want and confirm this with **OK**.

Showroom programme

The programme is for display use only.

The dishwasher is fitted with various demonstration programmes for showroom use.

The **Demo mode** and **Demo mode in continuous loop** programmes demonstrate the operation and functions of the dishwasher:

- **Demo mode:**
This programme is started by pressing a sensor. It will run through once and then has to be started again.
- **Demo mode in continuous loop:**
This programme will begin as soon as you switch it on and then will play in a continuous loop until you switch it off.
- **Demo with sound:**
This programme activates the pumps to demonstrate the sound of the dishwasher.
- **Demo programme:**
Using for the first time is disabled in the display.
- **Drying plus demo:**
The door will open automatically.

To switch Demo mode on

- Select the option you want and confirm this with **OK**.
- Confirm the following questions with **OK**.
- If necessary, touch any sensor to start the Demo mode you have selected.
- To cancel the Demo programme, touch any sensor again and confirm with it with **OK**.

To switch Demo mode off

- Select **Off** and confirm with **OK**.
- Confirm the question **Switch demo mode off?** with **OK**.

Factory default

If you have altered any settings from the factory default, you can re-set them back to the factory default settings.

- Confirm the question **Reset factory default settings?** with **OK**.
- Confirm **All settings reset** with **OK**.

To close the Settings ▸ menu

Touch the Clear sensor <C to come out of the Settings ▸ menu and return to the main menu.

Miele

United Kingdom

Miele Co. Ltd.
Fairacres, Marcham Road
Abingdon, Oxon, OX14 1TW
Tel: (01235) 554455
Fax: (01235) 554477
Customer Contact Centre Tel: (08707) 554466
E-mail: info@miele.co.uk
Internet: www.miele.co.uk

Australia

Miele Australia Pty. Ltd.
ABN 96 005 635 398
1 Gilbert Park Drive, Knoxfield, VIC 3180
Tel: (03) 9764 7130, Fax: (03) 9764 7149
Internet: www.miele.com.au

China

Miele Shanghai
Suite 4105-06, Plaza 66
1266 Nanjing Road West
Jing An District
Shanghai 200040, PRC
Tel: +86 21 6288 4200, Fax: +86 21 6288 4100
E-mail: mieleshanghai@cn.miele.com
Internet: www.miele.cn

Hong Kong

Miele (Hong Kong) Limited
AIA Plaza, 24th Floor
18 Hysan Avenue
Causeway Bay
Tel: +852- 2610-1331, Fax: +852-2610-1013
E-mail: mielehk@miele.com.hk
Internet: www.miele.hk

India

Miele Appliances India Pvt. Ltd.
Ground Floor, Copia Corporate Suites
Plot No. 9, Jasola
New Delhi – 110025
Tel: 011-46 900 000, Fax: 011-46 900 001
E-mail: customercare@miele.in
Internet: www.miele.in

Ireland

Miele Ireland Ltd.
Broomhill Road, Tallaght, Dublin 24
Tel: (01) 461 0710, Fax: (01) 461 07 97
E-Mail: info@miele.ie
Internet: www.miele.ie

New Zealand

Miele New Zealand Limited
Unit L, 10-20 Sylvia Park Road
Mt. Wellington, 1060, Auckland, NZ
Tel: 0800 264 353, Fax: 0800 463 453
Internet: www.miele.co.nz

Singapore

Miele Southeast Asia
Miele Pte. Ltd.
163 Penang Road
04 - 02/03 Winsland House II
Singapore 238463
Tel: +65 6735 1191, Fax: +65 6735 1161
E-Mail: infosea@miele.com.sg
Internet: www.miele.sg

South Africa

Miele (Pty) Ltd
63 Peter Place, Bryanston 2194
P.O. Box 69434, Bryanston 2021
Tel: +27 (0) 11 548-1900
Fax: +27 (0) 11 548-1935
E-mail: info@miele.co.za
Internet: www.miele.co.za

United Arab Emirates

Miele Appliances Ltd.
P.O. Box 11 47 82
Gold & Diamond Park
Sheikh Zayed Road
Building 6 / Offices Nos. 6-214 to 6-220
Dubai
Tel: +971-4-341 84 44
Fax: +971-4-341 88 52
E-Mail: info@miele.ae
Internet: www.miele.ae

Alteration rights reserved/
G1833/G2833 / 2709

M.-Nr. 07 502 390 / 01



Free Manuals Download Website

<http://myh66.com>

<http://usermanuals.us>

<http://www.somanuals.com>

<http://www.4manuals.cc>

<http://www.manual-lib.com>

<http://www.404manual.com>

<http://www.luxmanual.com>

<http://aubethermostatmanual.com>

Golf course search by state

<http://golfingnear.com>

Email search by domain

<http://emailbydomain.com>

Auto manuals search

<http://auto.somanuals.com>

TV manuals search

<http://tv.somanuals.com>