

Washing · Disinfection · Drying
A systematic approach to the reprocessing
of laboratory glassware





A systematic approach to the reprocessing of laboratory glassware

Systematic instrument reprocessing solutions

With washer-disinfectors, special reprocessing methods and accessories tailored to the specific needs of applications, Miele offers a comprehensive and systematic approach to the safe and thorough reprocessing of a wide range of laboratory glassware. Only a systematic approach can guarantee reproducible results in both simple and highly sophisticated applications in organic, inorganic and physical chemistry, biology, microbiology, in hospital laboratories, and in the pharmaceutical, food-processing and cosmetics industries. Miele's team of specialists is always on hand to assist laboratory staff in arriving at tailor-made solutions.

Contents

G 7883, G 7893, G 7883 CD washer-disinfectors	Page 4
G 7835 CD, G 7836 CD washer-disinfectors	Page 14
NetBox: Process documentation	Page 20
Qualification of cleaning systems	Page 22
Upper and lower baskets	Page 26
Inserts and mobile units for laboratory glassware	Page 28
Transport trolleys	Page 36
Plinths	Page 37
Dispenser modules for liquid detergent	Page 38
Demineralisation of water	Page 39
Soft water	Page 42
Technical data G 7883, G 7893, G 7883 CD	Page 44
Technical data G 7835 CD, G 7836 CD	Page 46

The wide-ranging benefits of the Miele System

Flexible and economical

- Washer-disinfectors with the capacity to meet all requirements
- Modular machine concept with basic features and optional extras
- Efficient single-chamber system for washing, rinsing, disinfecting and drying

Simple and intelligent

- Tried-and-tested standard programmes, innovative special programmes and programme packages
- Electronic controls offering excellent user convenience

Better be on the safe side!

- Serial interface for process documentation and optical interface for servicing
- Machine built to comply with EN ISO 15883
- Automatic allocation of mobile unit/load to appropriate programme using sensors

Sophisticated and innovative

- Intensive R&D and close cooperation with hygiene experts, scientists and users
- Trend-setting process development and technical features

All from a single source

- Miele offers its own advisory services and after-sales service network
- Qualification (Installation Qualification and Operation Qualification) of laboratory glassware cleaning systems
- Service contracts for peace of mind
- Attractive financing

Technical features vary according to the model

Practical experience combined with expertise Typically Miele



Manual v. machine-based reprocessing

Many laboratories have deliberately chosen to wash their laboratory glassware, e.g. beakers, pipettes, volumetrics and flasks, Erlenmeyer flasks, Petri dishes and test tubes, in a machine-based process. One reason for this is to avoid the risk of exposure to hazardous substances. Broken glass from manual cleaning, for instance, can cause serious injuries. Infectious and toxic contaminants pose a health hazard. Cleaning agents often contain substances that are highly irritant. Automatic, machine-based processes are also more easily standardised, validated and documented. Because washer-disinfectors operate as a closed system with programmes that run fully automatically, the potential risk to laboratory personnel can be kept to a minimum. This in turn means that machine preparation provides personnel with maximum protection.

Laboratories use a wide variety of equipment made from glass, ceramic ware and plastic for testing and analysis, creating reactions, for isolating or cleaning substances and for taking samples, etc. Following on from this, cleaning and drying are essential. The cleaning process must ensure that equipment, when re-used, is not affected by its previous use. Requirements vary widely from one laboratory to the next. To establish which machines and accessories, cleaning agents, water quality and cleaning programmes best suit an application, the following aspects need to be considered:

1. Applications

Applications subdivide into general areas (organic, inorganic or physical chemistry, biology, microbiology, hospital, pharmaceutical, food industry or cosmetic industry laboratories, etc.). The type of application will also be an important factor in determining the type of machine and accessories as well as the cleaning process and cleaning agents required.

2. Laboratory machines

Laboratory equipment needs to be classified according to its various components (beakers, conical flasks, measuring flasks and cylinders, pipettes, Petri dishes, test tubes, phials, centrifugal test tubes, etc.), and according to size and volume (1 ml, 500 ml, 1000 ml) and the number of items requiring processing. This information will enable us to quote the right system for your requirements.



3. Contamination

An intimate knowledge of the physical and chemical attributes of the contaminants the machine will need to deal with is of particular importance in choosing the most appropriate cleaning process and detergents.

Physical and chemical properties of a contaminant include, for instance, its solubility in water in acidic, pH-neutral and alkaline conditions, the efficacy of hydrolysis or oxidation, melting and softening points, its ability to emulsify as well as a substance's suspension or dispersing properties.

4. Disinfection

For certain applications laboratory glassware has to be disinfected. On the one hand this protects laboratory personnel who come into contact with bacterial contamination at work. And on the other, disinfection prevents bacterial cross-contamination of test samples and instruments in medical laboratories, hygiene institutes and pharmaceutical laboratories in the food and cosmetics industry.

5. Analytical Methods

The results of analyses can be falsified by contaminants on laboratory glassware. Knowledge of these factors can help in selecting the correct cleaning agent.

6. Analytical purity

Each laboratory has its own definition of "analytical purity", depending on specifications and the nature and reproducibility of test methods. The washer-disinfector, including all its accessories and the cleaning programme used, must be able to achieve cleaning results that meet the standards required by the application.

Miele's systematic approach covers the following process stages

- Cleaning, disinfection and drying
- Baskets and inserts
- Water treatment
- Detergent recommendations
- Compilation and analysis of cleaning programmes
- Machine commissioning by Miele Service
- Qualification package: Installation Qualification (IQ) and Operation Qualification (OQ)
- Peace-of-mind package including maintenance and service contracts



The illustration shows: – G 7883 lab washer – O 188/1 upper basket – E 106 insert – AK 12 insert
– U 874/1 lower basket – 2 x E 109 insert

G 7883, G 7893, G 7883 CD washer-disinfectors

NEW:

First 60 cm wide washer-disinfector with
integrated hot-air drying

Illustration shows machine with lid



G 7883 washer-disinfector

- H 850 (820), W 600, D 600 mm
- MULTITRONIC Novo Plus controls with 10 programmes
- Convertible to single-phase connection
- Integrated dispenser pump for process chemicals (neutralising agent)
- Capacity per batch: 39 narrow-necked glasses or 116 pipettes or 1600 test tubes



G 7893 washer-disinfector

- H 850 (820), W 600, D 600 mm
- MULTITRONIC Novo Plus controls with 10 programmes
- Integrated dispenser pump for process chemicals (neutralising agent)
- **Drying Plus:** Integrated hot-air drying
- Throughput per batch:
37 narrow-necked glasses or 96 pipettes
or 1600 test tubes



G 7883 CD washer-disinfector

- H 820 (850), W 900, D 700 mm
- MULTITRONIC Novo Plus controls with 10 programmes
- 2 integrated dispenser pumps for process chemicals (alkaline detergent/neutralising agent)
- Drawer with 2 supply containers, 5 l each
- Integrated hot-air drying unit
- Throughput per batch:
37 narrow-necked glasses or 96 pipettes
or 1600 test tubes

Miele laboratory glassware washers

Miele lab washers are available both as freestanding and built-under units. All machines are complete with supply lead (without plug), and water inlet and drainage hoses. Baskets and inserts for laboratory glassware are configured individually for the glassware load in hand. Further useful equipment, e.g. liquid dispensers for detergents and surfactants, are listed on Pages 38–42.

Hygiene, Safety, Efficiency

- Thorough cleaning and disinfection in a closed-circuit system
- Glassware reprocessing for analytical experiments
- Main wash/rinse cycle optionally with fully demineralised water
- Reproducible results, validatable and qualifiable processes
- Thermal disinfection
- Process documentation interface (depends on model)
- Extensive safety features in accordance with EN ISO 15883
- Connection option for liquid dispensing systems

- Optional version with oil- and grease-resistant gaskets for use in petrochemical, cosmetics and food-processing industries

Technical data Page 44/45

G 7883, G 7893, G 7883 CD washer-disinfectors



Illustr.: G 7883



Miele quality – Made in Germany

Dependable lab washers are indispensable in coping with the glassware used routinely in analytical experiments. Miele lab washers are uncompromising in terms of quality, offering users both economical and practical benefits. Each and every machine detail is closely geared to the requirements of laboratories requiring optimised processes, reproducible results and a high degree of reliability.



Design

- Freestanding/built-under unit
- Double-skinned design, insulated door for excellent soundproofing
- Wash cabinet and spray arms in high-grade stainless steel
- Fibre-reinforced hoses

Washing technology

- Hygienic freshwater system with fresh water intake for each programme stage
- 2 spray arms (third spray arm on upper basket) for thorough cleaning of laboratory glassware
- Optimum arrangement of spray nozzles and regulatable spray arm speed for best possible cleaning results
- Thorough cleaning of lumens with injector system
- Direct docking of upper baskets to water circuit for maximum utilisation of wash liquor

Standard features

- Profi-Monobloc water softener; reactivation internalised into programme cycle with only low salt consumption; separate reactivation not required
- Powerful circulation pump, max. throughput 400 l/min
- 4-fold filtration system with surface filter, coarse filter, glass splinter filter and micro-fine filter.
- Efficient steam condenser
- Flowmeter to monitor water intake quantities
- Integrated dispenser pump(s) for liquid products

- Connection option for liquid dispensing systems
- Hot-air drying on G 7893 and G 7883 CD

Interfaces

- Serial RS 232 interface for process documentation (depends on model)
- Optical interface for service and maintenance

Safety devices

- Electrical door interlock
- Programme safety cut out
- Optical and acoustic signal at end of programme
- 2 sensors, 1 each for temperature control and monitoring
- Port for simple positioning of sensors in the wash cabinet for machine or process validation

Quality, inside and out

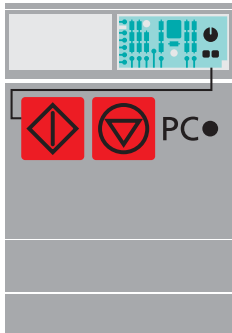

Electronic controls

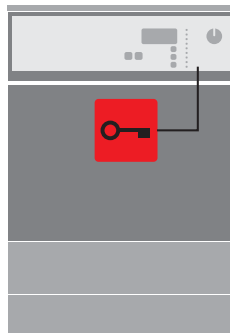

Door lock

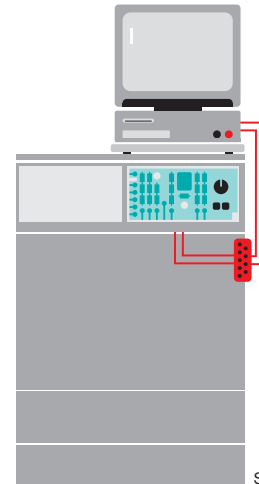

SST (serial interface)

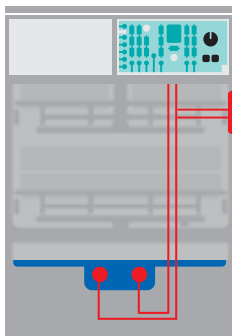

Temperature sensors

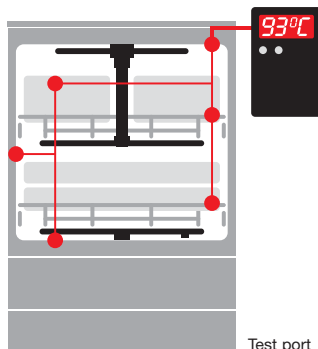

Test port

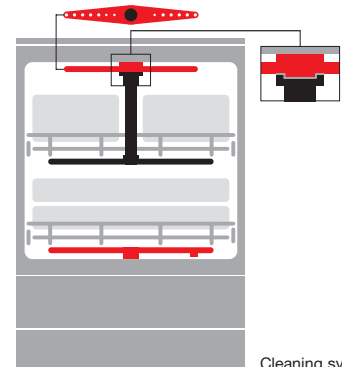

Cleaning system

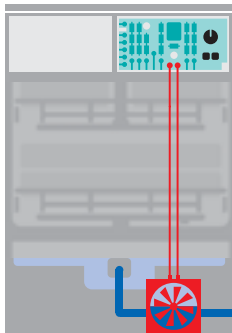

Flow meter

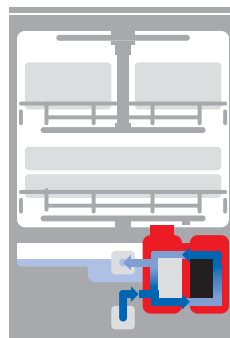

Water softener

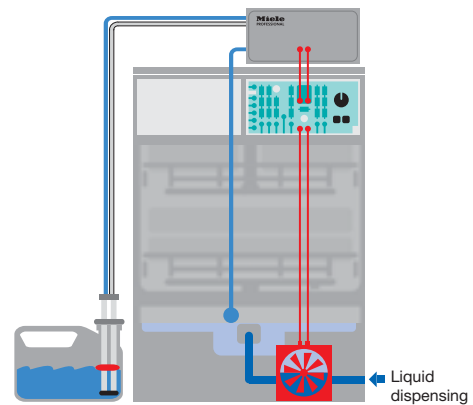

Liquid dispensing

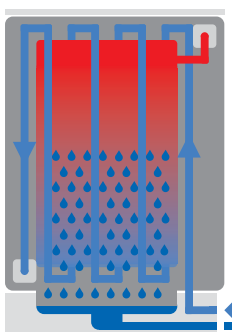

Steam condenser
Heat exchanger

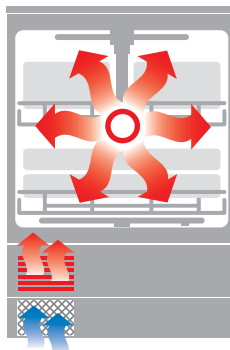

Hot-air drying

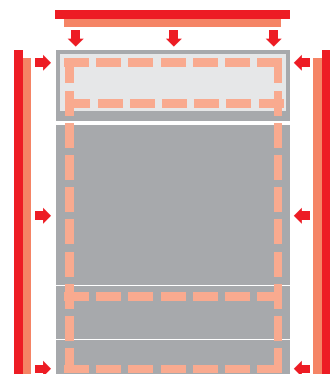

Spaceframe construction



NEW: G 7893 lab washer with **Drying Plus**

Miele, innovation leader in glassware reprocessing, is the first manufacturer to offer a 60 cm wide washer-disinfector with integrated **"Drying Plus"** hot-air drying. Miele's new machine concept enables comprehensive instrument reprocessing comprising thorough cleaning, safe disinfection and effective drying. All mobile units with a drying unit connection (TA) support the drying of inner surfaces as well as external drying.

Even intricately shaped glassware is properly reprocessed thanks to Miele's hot-air drying. An integrated HEPA filter (S class EU 12) guarantees the purity of the air used for drying. Filters are replaced simply and conveniently by opening the service hatch at the front of the machine to remove the filter.

Miele's new G 7893 washer-disinfector meets all requirements, offering Miele's proverbial quality – Made in Germany.



Air filter replacement



Wash cabinet with 2 wash levels



Wash cabinet with 2 spray arms



Water filtration system in cabinet



Direct docking onto water circuit



Direct docking onto water circuit



Hot-air drying

Controls · Programmes · Duration G 7883, G 7893, G 7893 CD

Illustration shows G 7883 CD



Fully electronic controls, excellent process security

Programmes and functions on Miele washer-disinfectors G 7883 and G 7893 CD are reliably controlled and monitored by MULTITRONIC controls. The majority of routine reprocessing tasks are covered by standard washing and disinfection programmes. Process parameters, reprogrammable within the individual blocks that constitute a programme cycle, allow further customising to cater for individual needs. The serial RS 232 interface (depends on model) allows all process data to be ported to a printer or PC for documentation. The protocol contains key programme data such as running times, temperatures, dispensing and information on errors and manual intervention.

Excellent user convenience

Self-explanatory symbols on fascia panel. The machine status is indicated at any given time via control lamps. A 3-digit 7-segment indicator in the display with its own toggle switch can be used to display the remaining programme duration or the current washing/disinfection temperature. Status and control indicators monitor the process and inform of faults and the need for servicing.

Features and functions

- Electronic controls MULTITRONIC NOVO PLUS
- 10 standard washing and disinfection programmes
- Parameters programmable in wash blocks
- 2 free programme slots for customised programmes
- Rotary programme selector switch
- Programme sequence indicator and fault and service indicators
- Temperature and programme duration indicator

G 7883/G 7893/G 7883 CD	Washing G 7883/G 7893/G 7883 CD					Drying G 7893/G 7883 CD	
	Duration [mins.]	Cold water [l]	Hot water [l]	AD [l]	Energy [kWh]	Duration [mins.]	Energy [kWh]
SPECIAL 93°C-10'	39	11.5	14.0	9.5	2.5	35	0.9
VARIO TD	39	21.5	14.0	9.5	2.3	35	0.9
VACANT PROGRAMME SLOT (PRG. A)	32	12.0	24.5	18.5	2.0	30	0.7
ANORGANICA (PRG. B)	35	11.0	19.5	23.5	2.2	30	0.7
ORGANICA (PRG. C)	34	2.0	35.0	18.5	2.1	30	0.7
STANDARD (PRG. D)	28	2.0	19.5	18.5	1.7	30	0.7
UNIVERSAL (PRG. E)	31	12.0	24.5	18.5	2.0	30	0.7
INTENSIVE (PRG. F)	38	12.0	19.5	28.0	2.4	30	0.7
PLASTICS (PRG. G)	26	34.5	0.0	18.5	1.7	40	0.5
Rinse ⊥	3	10.0	0.0	0.0	0.02	–	–

Heating: 9 kW (3N AC 400 V 9.7 kW),

excl. steam condenser

Connection to cold water (15°C), hot water (65°C) and demineralised water (15°C)

High performance, efficient use of energy

High performance, economical Miele washer-disinfectors offer a large inner cabinet with 2 wash levels (upper and lower baskets) for laboratory glassware and accessories. Direct docking of the upper basket onto the water circulation system reduces water consumption per cycle. Even the water entering the machine is carefully metered. A flowmeter monitors water intake quantities and thereby ensures precise detergent concentrations. Water and effluent costs are therefore reduced accordingly.

Specifications

Washer-disinfectors	Inner cabinet dimensions H/W/D [mm] Inner cabinet volume [l]	Cleaning performance [units]	Cleaning performance [units]
G 7883	500/535/Top 474, Bottom 516 125	116 pipettes	39 narrow-necked glasses
G 7893	500/535/Top 474, Bottom 516 125	96 pipettes	37 narrow-necked glasses
G 7883 CD	500/535/Top 474, Bottom 516 125	96 pipettes	37 narrow-necked glasses
G 7835 CD	500/535/Top 474, Bottom 516 125	96 pipettes	37 narrow-necked glasses
G 7836 CD	500/535/Top 474, Bottom 516 125	96 pipettes	66 narrow-necked glasses
G 7825/G 7826	683/541/610 225	116 pipettes	72 narrow-necked glasses
PG 8527/PG 8528	675/650/800 351	232 pipettes	115 narrow-necked glasses

O = Upper basket, U = Lower basket



The illustration shows: – G 7835 CD lab washer
– E 405/1 insert

G 7835 CD, G 7836 CD lab washers/washer-disinfectors

Illustration shows machine with lid



Washer-disinfector G 7835 CD

- Width 90 cm
- H 820 (850), W 900, D 700 mm
- Freely programmable Profitronic controls
- 2 bellows-type dispenser pumps for liquid detergent and neutralising agent
- Drawer with 2 supply containers, 5 l each
- Integrated hot-air drying unit
- Capacity per batch:
37 narrow-necked glasses or 96 pipettes
or 1600 test tubes

G 7836 CD washer-disinfector

- H 1175, W 900, D 700 mm
- Freely programmable Profitronic controls
- High-performance unit with 600 l/min water throughput
- 2 bellows-type dispenser pumps for liquid detergent and neutralising agent
- Drawer with 4 supply containers, 5 l each
- Integrated hot-air drying unit
- Batch capacity: 66 narrow-necked glasses or 96 pipettes or 1600 test tubes

Hygiene, Safety, Efficiency

- Thorough cleaning and disinfection in a closed-circuit system
- Glassware reprocessing for analytical experiments
- Main wash/rinse cycle optionally with fully demineralised water
- Reproducible results, validatable and qualifiable processes
- Thermal disinfection
- Process documentation interface
- Extensive safety features in accordance with EN ISO 15883
- Connection option for liquid dispensing systems
- Optional version with oil- and grease-resistant gaskets for use in petrochemical, cosmetics and food-processing industry

G 7835 CD, G 7836 CD washer-disinfectors



Illustration shows G 7835 CD



Miele quality – Made in Germany

Dependable lab washers are indispensable in coping with glassware used routinely in analytical experiments. Miele lab washers are uncompromising in terms of quality, offering users both economical and practical benefits. Each and every machine detail is closely geared to the requirements of laboratories requiring optimised processes, reproducible results and a high degree of reliability.



Design

- G 7835 CD = Built-under/freestanding unit
- G 7836 CD = Freestanding unit
- Double-skinned design, insulated door for excellent soundproofing
- Wash cabinet and spray arms in high-grade stainless steel
- Fibre-reinforced hoses

Washing technology

- Hygienic freshwater system with fresh water intake for each programme stage
- 2 spray arms (third spray arm on upper basket) for thorough cleaning of laboratory glassware
- Optimum arrangement of spray nozzles and regulatable spray arm speed for best possible cleaning results
- Thorough cleaning of lumens with injector system
- Direct docking of upper baskets to water circuit for maximum utilisation of wash liquor

Standard accessories

- G 7835 CD = Profi-Monobloc water softener
- G 7836 CD = High-capacity water softener
- Powerful circulation pump:
 - G 7835 CD = Qmax 400 l/min
 - G 7836 CD = Qmax 600 l/min
- 4-fold filtration system with surface filter, coarse filter, glass splinter filter and micro-fine filter.
- Efficient steam condenser
- Flowmeter to monitor water intake quantities

- Integrated dispenser pumps for liquid process chemicals
- Connection option for external liquid dispensing systems
- Hot-air drying for thorough drying of laboratory glassware

Controls

- 64 programme slots
- Customer-specific programme compilation option (cf. Page 18)

Interfaces

- Serial RS 232 interface for process documentation
- Optical interface for service and maintenance

Safety devices

- Electrical door interlock
- Programme safety cut out
- Optical and acoustic signal at end of programme
- 2 sensors, 1 each for temperature control and monitoring
- Port for simple positioning of sensors in the wash cabinet for machine or process validation

Quality, inside and out



Rear of G 7835 CD



Drawer for 2 supply canisters



Wash cabinet with 2 wash levels



Wash cabinet with 2 spray arms



Magnetic strip for automatic mobile unit recognition



Filtration system in cabinet



Direct docking onto water circuit



Hot-air drying

Controls · Programmes · Duration

G 7835 CD, G 7836 CD



Fully electronic controls, high degree of process security

Miele's G 7835 CD and G 7836 CD washer-disinfectors are controlled and monitored by fully electronic PROFITRONIC controls. This set of freely programmable controls offers 64 programme slots. In addition to standard and service programmes, up to 40 programme slots are available for customers' own programmes. Depending on the model, machines are fitted ex works with Miele's innovative OXIVARIO programme. OXIVARIO additionally dispenses hydrogen peroxide during the alkaline main wash cycle. This optimises results in the fields of organic chemistry and microbiology.

Excellent user convenience

During programme cycles, a large, user-friendly display provides the user with information on the programme number, programme name, programme block and target/actual process parameters (e.g. temperature, water intake volume, etc.). Users can choose from 6 pre-loaded languages and select 1 additional programmable language. Automatic mobile unit recognition assigns the correct reprocessing programme on the basis of load information provided by a magnetic strip on the mobile unit.

A serial RS 232 process documentation interface is a standard feature on these units. The optical interface facilitates service work.

Features and functions

- Freely programmable PROFITRONIC controls
- 64 programme slots with 11 standard washing and disinfection programmes
6 special programmes
7 service programmes
40 vacant programme slots
- User navigation with local-language display
- Display of programme selection and programming dialogs, programme sequence, temperature, countdown time, faults, operating hours.
- Compilation of new programmes using machine controls or using PC/laptop via optical interface

G 7836 CD	Cleaning					Drying*	
	Duration [mins.]	Cold water [l]	Hot water [l]	AD [l]	Energy [kWh]	Duration [mins.]	Energy [kWh]
SPECIAL 93°C-10'	50	21.0	25.5	15.5	4.3	38	0.7
SPECIAL 93/10 AN	58	28.5	34.5	21.0	4.9	54	0.9
DES-VAR-TD	50	41.5	19.0	15.5	3.8	33	0.5
DES-VAR-TD AN	61	49.0	33.5	21.0	4.0	50	0.8
VAR-TD-NR	44	29.5	18.5	15.5	3.6	33	0.5
SHOE-TD-75/2	27	26.5	21.0	15.5	1.3	38	0.4
LAB-STANDARD	36	8.5	38.5	16.0	2.8	34	0.7
LAB-UNIVERSAL	42	7.5	54.0	16.0	2.8	34	0.7
LAB-INTENSIVE	47	7.5	54.0	16.0	3.3	34	0.7
ORGANIC	47	–	63.0	16.0	3.4	34	0.7
INORGANIC	45	–	48.0	46.0	2.7	34	0.7
CHEM-DESIN	37	26.5	52.0	–	1.8	41	0.4
CHEM-DESIN	38	26.5	36.5	–	1.7	41	0.4
CHEM-DES-INTENS	40	26.5	53.0	–	1.6	41	0.4
OXIVARIO	66	43.5	35.5	31.5	4.8	33	0.5
OXIVARIO PLUS	76	32.0	30.0	48.5	5.1	33	0.5

*with 6-minute steam condensation pause (No. 48-50 4.33 mins.)

Heating: 9 kW (3N AC 400 V 10.2 kW)

Connection to cold water (15°C), hot water (65°C) and demineralised water (15°C)

G 7835 CD	Cleaning					Drying	
	Duration [mins.]	Cold water [l]	Hot water [l]	AD [l]	Energy [kWh]	Duration* [mins.]	Energy [kWh]
with steam condenser							
SPECIAL 93°C-10'	41	14.0	15.5	9.5	3.1	38	0.8
DES-VAR-TD	39	22.5	14.0	10.5	2.4	33	0.6
SHOE-TD-75/2	24	17.5	22.5	0.0	1.6	38	0.5
LABOR-STANDARD	32	10.5	28.0	9.5	1.8	33	0.7
ORGANIC	37	1.0	38.5	10.5	2.3	33	0.7
INORGANIC	38	1.0	38.5	18.5	1.8	33	0.7

*Programme duration with steam condensation pause and gentle start

Heating: 9 kW (3N AC 400 V 9.6 kW)

Connection to cold water (15°C), hot water (65°C) and demineralised water (15°C)

Note:

The G 7835 CD washer-disinfector features the same programmes as the G 7836 CD.

Further information on programme durations, etc., on request.

NetBox: Process documentation in laboratories



Process documentation principles

A significant aspect of quality assurance in the reprocessing of laboratory glassware is the documentation of process data. Washing and disinfection is performed using validatable processes, whereby validation includes the need for documentation. Proof that a validated process can be replicated with each batch is best achieved by recording and documenting the most important programme parameters. To facilitate process documentation on a PC, Miele has cooperated with IBH Data Technology GmbH in designing the NetBox documentation system, tailored to the needs of Miele washer-disinfectors. NetBox is a proprietary and comprehensive system consisting of both hard- and software. It allows process protocols from up to 4 washer-disinfectors to be processed and archived.

Effective process documentation system requirements

- Comprehensive system with high level of process security, including pre-installed and configurable software
- Tamper-proof
- Simple operation without knowledge of PCs
- Simple installation
- Process visualisation
- Batch-related documentation
- Documented batch approval
- Long-term archiving

System components

- NetBox with keypad and mouse plus cables for connection to washer-disinfector

Optional:

- Flat screen for process visualisation and load data capture
- Barcode scanner (with connection lead or wireless using Bluetooth technology) to simplify machine operation and load data capture
- RFID transponder as alternative to barcode system
- Network cable if documentation is to be installed in a network

Load allocation, data storage and archiving

NetBox protocols:

Safe and convenient

The NetBox is a complete documentation system including pre-configured software. The system is connected via an interface to the washer-disinfector. The NetBox collects all relevant process data during washing and disinfection programmes. In standard mode, the unit harvests data fully automatically without any involvement on the part of the user. This means maximum operating safety as the NetBox provides considerable protection against operating errors. Once collated, process data remains in memory; the NetBox has the capacity to save up to 1000 batch protocols. Later, data can be saved to a network or a storage device.

In network mode, the unit can be monitored and operated via a PC interface. A flat-screen monitor is also available as an optional extra to plot time/temperature curves. This also helps visualise the data contained in the wash protocol. A further optional extra is a barcode scanner or RFID transponder to facilitate the fast and simple identification of loads. The user can also approve or lock batches, depending on process cycles.

As soon as data is received from a washer-disinfector a batch number is automatically allocated and a report generated.

Depending on the machines, protocols can contain the following parameters:

- Batch no., date and Mach. no.
- Programme name
- Programme starting and ending time and times of individual programme blocks
- Dispenser pump (ID no.), chemical concentration, temperature and times
- Target temperature reached
- Disinfection temperature and holding time
- Faults (e.g. water inlet)
- Manual intervention and outages (e.g. programme aborted, power failure)

On washer-disinfectors with Profitronic controls, the intervals at which the time/temperature profile is plotted (e.g. every 10 secs.) can be defined by the user.

Clip with barcode attached to inserts



Scanning of barcode



Scanning of staff barcode after batch approval



Protocol administration

At the end of a programme, a batch protocol is added to the protocol database. All protocols can be called up at any time to check protocol parameters such as Batch no., Mach. no., user, etc. Data records are write-protected and cannot be modified. All persons authorised to access the process documentation programme are recorded in master records as authorised users. Access can also be password-protected. An access code determines the access rights of a user on the system.

Evaluations

NetBox represents an integrated approach to statistical programme evaluations. Saved data can also be made available to other programmes for further processing and evaluation.

A key advantage of the NetBox in comparison to PC-based systems is the operational safety factor. NetBox process documentation also simplifies installation and operation, requires a minimum of space, is ventilator-free and low-cost.

The process documentation software is optionally available as a software-only solution for installation on a Windows PC.



Miele Service Pack: Qualification of cleaning systems

In the pharmaceutical, food-processing and cosmetics industries, all cleaning systems used in production, quality assurance and R&D must be “qualified”.

Qualification involves the following: Design Qualification (DQ), Installation Qualification (IQ), Operation Qualification (OQ), Performance Qualification (PQ) and, in some cases, process validation. In all cases, responsibility for implementing the necessary measures lies with the equipment operator. Miele's in-house after-sales service operation, though, can provide support by assuming some of the duties incumbent on the operator. Miele's tailored service package covers Installation and Operation Qualification (IQ/OQ).

Installation Qualification (IQ)

The objective of Installation Qualification is to verify that the cleaning system and its installation comply with the operator's and manufacturer's requirements. During the IQ inspection, Miele service engineers document, check and assess the following: Compliance of shipment with original order, unit configuration and condition, installation and connection to on-site utilities and the calibration of certain measuring systems.

Implementation

Before IQ/OQ can be performed by Miele's in-house service engineers the necessary documentation must be compiled, checked and approved by the operator for use during the inspection. Miele service technicians will then perform qualification on the basis of this documentation. All the necessary calibrated and certified test apparatus is provided by Miele.

Operation Qualification (OQ)

The objective of Operation Qualification is to furnish proof that the cleaning system meets the requirements of the operator and equipment manufacturer when installed and connected. Operation Qualification documentation, inspections and evaluation cover functions with a relevance to safety and operation, process-related messages and warnings, and programme sequence.

Training of service engineers

Miele's own service engineers are given training covering all aspects of machine technology (installation, programming, repair and maintenance) in regular refresher courses. This is complemented by specialised training on the qualification of Miele cleaning systems used in industrial and laboratory operations. Theory and practice are not confined to washer-disinfectors either: they also cover all peripheral units likely to be encountered in industrial applications (for example Miele's Aqua Purificator to produce demineralised water, dispensing systems and accessories such as mobile injector units and inserts).

Training of operatives and the documentation of such measures is also carried out during Operation Qualification. This constitutes a comprehensive package comprising IQ/OQ paperwork, the services of highly skilled and qualified service engineers and the use of calibrated, certified test apparatus.



Large-capacity

Miele laboratory glassware washers



Alongside compact freestanding and undercounter models, Miele also manufactures high-performance units for central reprocessing of large quantities of laboratory glassware. Large decontamination units are available as single-door and 2-door (barrier) models. The latter, installed in a diaphragm wall, allows the segregation of clean and contaminated operations. Here, too, the single-chamber principle adopted by Miele, allowing washing, rinsing, disinfection and drying in a single cabinet, has proved to be particularly flexible and economical.

G 7825 and G 7826 washer-disinfectors

- G 7825: Single-door frontloading version with bottom-hinged door
- G 7826: Two-door barrier machine with bottom-hinged doors
- Useable cabinet dimensions: H 683, W 541, D 610 mm
- Useable cabinet volume: 225 l
- Freely programmable Profitronic controls
- Batch capacity: 72 narrow-necked glasses or 104 pipettes
- External dimensions: H 2404, W 900, D 750 mm (including plinth and top-box panelling)

G 8527 and G 8528 washer-disinfectors

- PG 8527: Single-door frontloading version with vertical sliding door
- PG 8528: Two-door barrier machine with vertical sliding doors
- Useable cabinet dimensions: H 675, W 650, D 800 mm
- Useable cabinet volume: 351 l
- Freely programmable PROFITRONIC+ controls
- Batch capacity: 232 narrow-necked glasses or 232 pipettes
- External dimensions: H 2420, W 1150, D 870 mm (incl. plinth and drying unit)

Perfect Miele

- PERFECT TOUCH CONTROL: User-friendly graphic interface with hygienic glass display
- PERFECTVISION: All-glass doors and cabinet lighting
- PERFECTSPEED CONTROL: Spray arm sensing
- PERFECTPURE SENSOR: Measures conductivity of wash liquor
- PERFECTFLOW SENSOR: Dispensing volume control
- PERFECT HEPA DRYING: Optimised air circuit with HEPA Class EU 13 filter

For detailed description see the brochure: Large-capacity lab washers and washer-disinfectors

Upper and lower baskets



O 188/1 upper basket/carrier

For use in G 7883, G 7893, G 7883 CD, G 7835 CD, G 7836 CD

- Open front
- For various inserts
- Clearance 165 mm
- Height adjustment +/- 20 mm
- Built-in spray arm
- H 215, W 531, D 475 mm



O 190/1 upper basket/carrier

- As O 188
- Clearance 215 mm
- H 265, W 531, D 475 mm
- Powder dispensing not possible

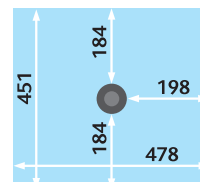

U 874/1 lower basket/open front

For use in G 7883, G 7893, G 7883 CD, G 7835 CD, G 7836 CD

- Open front
- For various inserts
- Clearance in combination with upper basket:
 - 175 TA approx. 230 mm +/- 20 mm
 - 187 approx. 225 mm +/- 20 mm
 - 184 approx. 205 mm +/- 20 mm
 - 188/1 approx. 270 mm +/- 20 mm
 - 190/1 approx. 220 mm +/- 20 mm
- With holder for ML/2 magnetic strip for automatic mobile unit recognition
- H 50, W 534, D 515 mm

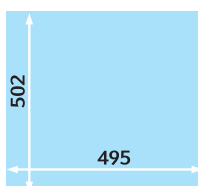

Upper and lower baskets



O 175 upper basket/injector unit (with drying unit connection)

For use in G 7893, G 7883 CD, G 7835 CD, G 7836 CD

- For narrow-necked laboratory glassware
- Clearance 170 mm*
- Connection for hot-air drying unit
- H 250, W 531, D 475 mm,
H with drying unit connection 412 mm
- Powder dispensing not possible

Supplied as standard with:

- 33 nozzles (E 351) 4 x 160 mm
- 33 x clips for nozzles, 4 x 160 mm (E 353)



O 187 upper basket/injector unit

For use in G 7883, G 7893, G 7883 CD, G 7835 CD, G 7836 CD

- For narrow-necked laboratory glassware
- Clearance 170 mm*
- H 250, W 531, D 475 mm
- Powder dispensing not possible

Supplied as standard with:

- 34 nozzles (E 351) 4 x 160 mm
- 34 x clips for nozzles, 4 x 160 mm (E 353)



O 184 upper basket/injector unit (with drying unit connection)

For use in G 7883, G 7893, G 7883 CD, G 7835 CD, G 7836 CD

- For items such as centrifuge tubes, phials, test tubes for fraction collectors or autosampler tubes
- Clearance 170 mm
- Connection for hot-air drying unit
- H 260, W 531, D 475 mm,
H with drying unit connection 468 mm
- Powder dispensing not possible

Supplied as standard with:

- 96 nozzles 2.5 x 110 mm with plastic supports



U 175/1 lower basket/mobile injector unit

For use in G 7836 CD

- For narrow-necked glassware
- Clearance approx. 170 mm*
- Only for use in conjunction with
O 175/O 187/O 184 upper baskets
- H 250, W 531, D 475 mm

Supplied as standard with:

- 33 nozzles (E 351) 4 x 160 mm
- 33 x clips for nozzles (E 353), 4 x 160 mm
- 1 irrigation nozzle



U 184/1 lower basket/mobile injector unit

For use in G 7836 CD

- For items such as centrifuge tubes, phials, test tubes for fraction collectors or autosampler tubes
- Only for use in conjunction with
O 175/O 187/O 184 upper baskets
- Clearance approx. 170 mm
- H 250, W 531, D 515 mm

Supplied as standard with:

- 96 nozzles, 2.5 x 90 mm with plastic supports

* Clearance may be less, depending on type of laboratory glassware

Inserts for test tubes, funnels, beakers



E 103/1 insert 1/4

- For use in G 7883, G 7893, G 7883 CD, G 7835 CD, G 7836 CD, upper + lower b.
- For ca. 200 test tubes, max. 12 x 75 mm
 - Subdivided into 6 compartments
 - Incl. A 13 cover
 - Mesh size 8 x 8 mm
 - H 102 (122), W 200, D 320 mm

E 104/1 insert 1/4

- For use in G 7883, G 7893, G 7883 CD, G 7835 CD, G 7836 CD, upper + lower b.
- As per E 103/1, but for test tubes, max. 12 x 105 mm
 - H 132 (152), W 200, D 320 mm

E 105/1 insert 1/4

- For use in G 7883, G 7893, G 7883 CD, G 7835 CD, G 7836 CD, lower basket
- As per E 103/1, but for test tubes, max. 12 x 165 mm
 - Mesh size 9 x 9 mm
 - H 192 (212), W 200, D 320 mm

E 139/1 insert 1/4

- For use in G 7883, G 7893, G 7883 CD, G 7835 CD, G 7836 CD, lower basket
- As per E 103/1, but for test tubes, max. 12 x 200 mm
 - Mesh size 9 x 9 mm
 - H 223 (243), W 200, D 320 mm



A 13 lid

- Replacement for E 103/1, E 104/1, E 105/1 and E 139/1 inserts
- Stainless steel
- 1 mm wire mesh
- 8 mm mesh size
- 4 mm all-round frame



E 149 insert 1/4

- For use in G 7883, G 7893, G 7883 CD, G 7835 CD, G 7836 CD, upper and lower baskets
- For 80 test tubes, max. 16 x 105 mm
 - Incl. A 13 cover
 - 80 sections 18 x 18 mm
 - Base mesh size 8 x 8 mm



AK 12 insert 1/2

- For use in G 7883, G 7893, G 7883 CD, G 7835 CD, G 7836 CD, upper and lower baskets
- For funnels, beakers, wide-necked glassware, etc.
 - H 67/127, W 225, D 442 mm



A 14 lid 1/4

- For AK 12 insert
- Stainless steel
- 7 x 7 mm perforations, 3 mm ridge
- H 20, W 210, D 210 mm

Inserts for Petri dishes, watch glasses, etc.



E 118 insert 1/1

For use in G 7883, G 7893, G 7883 CD, G 7835 CD, G 7836 CD, upper and lower baskets

- For 38 Petri dishes 100 mm dia.
- 38 holders, Height 70 mm
- Spacing approx. 26 mm
- H 120, W 460, D 445 mm



E 136 insert 1/1

For use in G 7883, G 7893, G 7883 CD, G 7835 CD, G 7836 CD, lower basket

- For 56 Petri dishes 100 mm dia.
- 56 holders, Height 70 mm
- Spacing approx. 26 mm
- H 145, W 485, D 445 mm



E 137 top insert 1/1 for E 136

- For 56 Petri dishes 100 mm dia.
- 56 holders, Height 70 mm
- Spacing approx. 26 mm
- H 95, W 485, D 445 mm



E 134 insert 1/2

For use in G 7883, G 7893, G 7883 CD, G 7835 CD, G 7836 CD, upper and lower baskets

- For 210 slides
- 210 compartments, 26 x 11 mm
- Wire gauge 3 mm
- H 73, W 200, D 445 mm



E 402 insert 1/2

For use in G 7883, G 7893, G 7883 CD, G 7835 CD, G 7836 CD, upper and lower baskets

- For 44 Petri dishes 80–125 mm dia.
- 23 holders, spacing 15 mm
- H 53, W 200, D 445 mm



E 403 insert 1/2

For use in G 7883, G 7893, G 7883 CD, G 7835 CD, G 7836 CD, upper and lower baskets

- For 105 Petri dishes 50–60 mm dia.
- 36 holders, spacing 9 mm
- H 35, W 200, D 445 mm

O = Upper basket

U = Lower basket

Inserts for wide-necked glassware



E 106/2 insert 1/2

For use in G 7883, G 7893, G 7883 CD, G 7835 CD, G 7836 CD, lower basket

- 13 spring hooks, H 175 mm, spacing approx. 85 mm
- H 186, W 180, D 420 mm



E 106 insert 1/2

For use in G 7883, G 7893, G 7883 CD, G 7835 CD, G 7836 CD, lower basket

- For wide-necked glassware, measuring beakers, etc.
- 10 spring hooks, H 175 mm
- 16 spring clips, H 105 mm, spacing approx. 60 mm
- H 186, W 195, D 430 mm



E 106/1 insert 1/2

For use in G 7883, G 7893, G 7883 CD, G 7835 CD, G 7836 CD, upper and lower baskets

- 26 spring hooks, H 105 mm, spacing approx. 60 mm
- H 116, W 195, D 410 mm



E 109 insert 1/2 (illustrated)

For use in G 7883, G 7893, G 7883 CD, G 7835 CD, G 7836 CD, lower basket

- For 21 beakers up to 250 ml
- 21 x 3 spikes
- H 155, W 230, D 460 mm

E 110 insert 1/2

For use in G 7883, G 7893, G 7883 CD, G 7835 CD, G 7836 CD, lower basket

- For 10 beakers, 250 to 600 ml
- 10 x 3 spikes
- H 175, W 230, D 460 mm

E 111 insert 1/2

For use in G 7883, G 7893, G 7883 CD, G 7835 CD, G 7836 CD, lower basket

- For 8 beakers, 600 to 1000 ml
- 8 x 3 spikes
- H 205, W 230, D 460 mm

E 144 insert 1/2

For use in G 7883, G 7893, G 7883 CD, G 7835 CD, G 7836 CD, upper and lower baskets

- For 18 beakers up to 250 ml
- 18 x 3 spikes
- H 131, W 200, D 445 mm

O = Upper basket

U = Lower basket

Inserts for micro-titre plates, Mobile injector unit for pipettes



E 493 mobile unit

For use in G 7836 CD

- For 8 x E 494 inserts for micro-titre plates on 4 levels
- To ensure optimum results, the lower spray arm must be replaced with the enclosed flange.
- Clearance from bottom upwards:
 - Level 1: 70 mm
 - Level 2: 85 mm
 - Level 3: 85 mm
 - Level 4: 90 mm



E 494 insert 1/2

- For 5 micro-titre plates
- H 35, W 205, D 480 mm



E 406 mobile injector unit

For use in G 7883

- For 116 pipettes up to 450 mm
- Compartment size 16 x 16 mm
- Complete with retaining frame, height 150 mm
- H 502, W 533, D 516 mm

E 408 mobile injector unit (with drying unit connection)

For use in G 7893, G 7883 CD, G 7835 CD, G 7836 CD

- As E 406 but for 96 pipettes
- Connection for hot-air drying unit
- With holder for ML/2 magnetic strip for automatic mobile unit recognition



E 404/1 mobile unit

For use in G 7883

- For 38 pipettes in 3 rows:
 - Row 1 10 pipettes 100 ml (length up to 550 mm), spacing 20 mm,
 - Row 2 14 pipettes 25 ml
 - Row 3 14 pipettes 10 ml, Spacing 26 mm

E 405/1 mobile injector unit with drying connection

For use in G 7893, G 7883 CD, G 7835 CD, G 7836 CD

- As per E 404/1
- Connection for hot-air drying unit
- With holder for ML/2 magnetic strip for automatic mobile unit recognition

O = Upper basket

U = Lower basket

Mobile injector units for narrow-necked glassware



E 355 mobile injector unit 1/2

For use in G 7883

- For narrow-necked glassware
- One half vacant for other inserts

Supplied as standard with:

- 7 x E 351 nozzles, 4.0 x 160 mm
- 7 x E 353 clips for injector nozzles, 4.0 x 160 mm
- 9 x E 352 nozzles, 6.0 x 220 mm
- 9 x E 354 clips for injector nozzles, 6.0 x 220 mm
- 1 x irrigation nozzle for powder dispenser



E 385 mobile injector unit 1/2 (with drying unit connection)

For use in G 7893, G 7883 CD, G 7835 CD, G 7836 CD

- As E 355 universal mobile unit, but with connection for hot air drying unit
- With holder for ML/2 magnetic strip for automatic mobile unit recognition

Supplied as standard with:

- 7 x E 351 nozzles, 4.0 x 160 mm
- 7 x E 353 clips for injector nozzles, 4.0 x 160 mm
- 9 x E 352 nozzles, 6.0 x 220 mm
- 9 x E 354 clips for injector nozzles, 6.0 x 220 mm
- 1 x irrigation nozzle for powder dispenser



E 350 mobile injector unit 1/1

For use in G 7883

- For narrow-necked glassware

Supplied as standard with:

- 15 x E 351 nozzles, 4.0 x 160 mm
- 15 x E 353 clips for injector nozzles, 4.0 x 160 mm
- 18 x E 352 nozzles, 6.0 x 220 mm
- 18 x E 354 clips for injector nozzles, 6.0 x 220 mm
- 1 x irrigation nozzle for powder dispenser



E 380 mobile injector unit 1/1 (with drying unit connection)

For use in G 7893, G 7883 CD, G 7835 CD, G 7836 CD

- As per E 350, but with 32 nozzles/clips
- Connection for hot-air drying unit
- With holder for ML/2 magnetic strip for automatic mobile unit recognition

Supplied as standard with:

- 14 x E 351 nozzles, 4.0 x 160 mm
- 14 x E 353 clips for injector nozzles, 4.0 x 160 mm
- 18 x E 352 nozzles, 6.0 x 220 mm
- 18 x E 354 clips for injector nozzles, 6.0 x 220 mm
- 1 x irrigation nozzle for powder dispenser

Mobile injector unit for narrow-necked glassware

Mobile unit for butyrometers



E 340 mobile injector unit 1/2

For use in G 7883

- For narrow-necked glassware
- One half vacant for other inserts

Supplied as standard with:

- 3/3/3 nozzles, 4.0 x 140/160/180 mm
- 3/4/3 nozzles, 6.0 x 200/220/240 mm
- 1 x irrigation nozzle for powder dispenser



E 329 mobile injector unit 1/1

For use in G 7883

- For narrow-necked glassware

Supplied as standard with:

- 4/5 nozzles, 2.5 x 90/110 mm
- 5/5/5 nozzles, 4.0 x 140/160/180 mm
- 5/5/5 nozzles, 6.0 x 200/220/240 mm
- 1 x irrigation nozzle for powder dispenser



E 414 mobile injector unit 1/1 (with drying unit connection)

For use in G 7893, G 7883 CD, G 7835 CD, G 7836 CD

As E 329 but with 37 nozzles

- Connection for hot-air drying unit
- With holder for ML/2 magnetic strip for automatic mobile unit recognition

Supplied as standard with:

- 4/3 nozzles, 2.5 x 90/110 mm
- 5/5/5 nozzles, 4.0 x 140/160/180 mm
- 5/5/5 nozzles, 6.0 x 200/220/240 mm
- 1 x irrigation nozzle for powder dispenser



E 331 mobile injector unit 1/1

For use in G 7883, G 7893, G 7883 CD, G 7895 CD, G 7836 CD

- For butyrometers

Supplied as standard with:

- 39 SD-B injector nozzles for butyrometers
- 1 x irrigation nozzle for powder dispenser



SD-B injector nozzle for butyrometers

- For E 331 mobile injector unit
- L 240 mm incl. thread, 4 x 140 mm plus welded, compressed nozzle, 1.5 x 100 mm

Accessories



E 336 injector sleeve MIBO

- For pipettes (max. length 445 mm) in injector mobile units
- Plastic, with screw fitting
- Ø 11 mm
- Length 121 mm



E 352 injector nozzle ①

- For mobile injector unit
- In conjunction with E 354
- 6 x 220 mm, screw thread

E 351 injector nozzle ②

- For mobile injector unit
- In conjunction with E 353
- 4 x 160 mm, screw thread

E 354 clip for nozzle ③

- For E 352 injector nozzle
- Height-adjustable
- 6 x 220 mm

E 353 clip for nozzle ④

- For E 351 injector nozzle
- Height-adjustable
- 4 x 160 mm

E 470 injector nozzle with clip ⑤

- For mobile injector unit
- 2.5 x 90 mm, screw thread



Injector nozzle with plastic support

Front row, from left

ID 160 4 x 160 mm

ID 140 4 x 140 mm

ID 110 2.5 x 110 mm

ID 90 2.5 x 90 mm

Rear row, from left

ID 240 6 x 240 mm

ID 220 6 x 220 mm

ID 200 6 x 200 mm

ID 180 4 x 180 mm



E 362 blind stopper

- M 8 x 1 thread, to close connectors on mobile units

Accessories

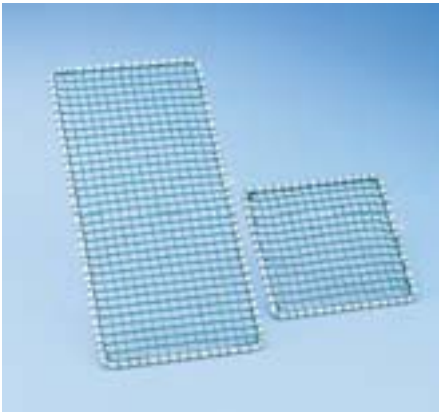

A 2 cover net 1/2

- Plastic-coated metal frame with plastic netting
- For 1/2 inserts
- 216 x 456 mm

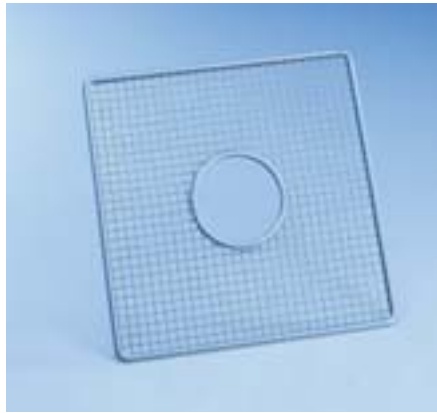

A 5 cover

- For O and U 184
- H 8, W 280, D 280 mm



A 6 cover net 1/2

- Stainless-steel with polypropylene mesh
- Particularly resilient and durable
- e.g. for mesh tray E 142
- 215 x 460 mm

A3 cover net 1/4

- Plastic-coated metal frame with plastic netting
- For 1/4 inserts
- 206 x 206 mm

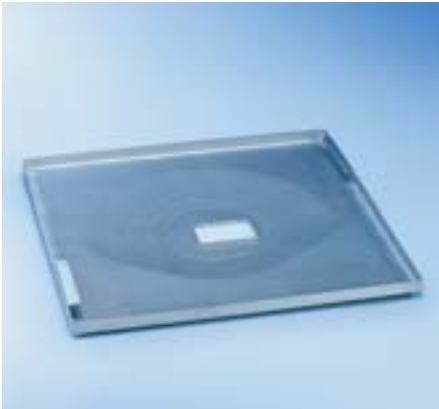

E 319/3 insert 1/1

- Surface area filter for coarse soiling
- Contains soiling, e.g. labels from laboratory glassware, glass splinters, etc.
- W 500, D 488 mm

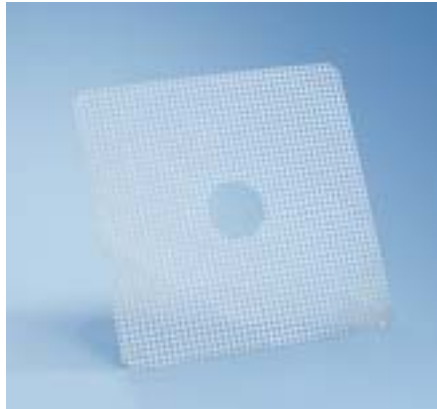

A 11/1 insert 1/1 sub-frame

- With perforations 7 x 7 mm
- For upper or lower basket
- Stainless steel
- W 429, D 429 mm



A 12/1 insert 1/2 sub-frame

- With perforations 7 x 7 mm
- For upper or lower basket
- Stainless steel
- W 429, D 224 mm

O = Upper basket
U = Lower basket

Accessories



MT Mieltrans trolley

- Trolley for storing and transporting baskets and inserts
- 4 height-adjustable levels
- Loading dimensions
W 549 x D 599 mm
- Height-adjustment increments 102.5 mm
- 4 lockable wheels
- H 1985, W 616, D 662 mm



MC/1 Mielcar trolley

- For loading washer-disinfectors and handling baskets and inserts
- 2 levels (sloping towards centre)
- Rail handle and docking plate
- Docking height H 640–885 mm, infinitely adjustable
- 4 wheels, of which 2 are lockable
- H 1000, W 630, D 814 mm
(D 960 mm with docking plate in vertical position)

For use on G 7836 CD and washer-disinfectors installed on 30 cm plinth

Plinths

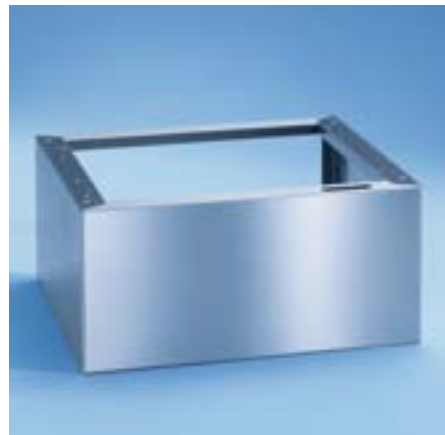

UE 30-30/60-78 plinth (top)

- For use with G 7895/1 and G 7896
- Stainless-steel plinth, bolted to machine
- H 300, W 300, D 600 mm

UE 30-60/60-78 plinth (bottom)

- For use on G 7883 and G 7893 CD
- Stainless-steel plinth, bolted to machine
- H 300, W 600, D 600 mm

UC 30-90/60-78 plinth (illustrated)

- For use with G 7883 and G 7893 in combination with G 7895/1 or G 7896
- Stainless-steel plinth, bolted to machine
- H 300, W 900, D 600 mm

UC 30-90/70-78 plinth

- For G 7883 CD and G 7835 CD
- Stainless-steel plinth, bolted to machine
- H 300, W 900, D 700 mm

Accessories for dispensing liquid products



G 7896 DOS chemical supply unit

- Housing unit for DOS modules and supply containers
- H 850 (820), W 300, D 600 mm
- Compatible with G 7883/G 7893 and G 7835 CD
- Freestanding unit, can be built under
- Unit with removable outer door panelling available in stainless steel or white
- Internal dimensions: H 530, W 249, D 480 mm
- 3 levels
Level 1: Pull-out drawer on telescopic runners for max. 3 DOS modules.
Levels 2 and 3: Pull-out drawer on telescopic runners with drip tray and retainer for storage of supply containers.

Note:

The use of liquid detergent is recommended in the DESIN vario TD programme.

- The following canister sizes can be used, L x H x W:

4 x 5 l: 245 x 145 x 225 mm*

2 x 10 l: 140 x 193 x 307 mm

2 x 10 l: 223 x 203 x 321 mm

2 x 10 l: 229 x 193 x 323 mm

2 x 10 l: 194 x 204 x 353 mm

1 x 20 l: 289 x 233 x 396 mm

1 x 25 l: 288 x 234 x 456 mm

* Only possible with DOS G 60/1 or DOS K 60/1 dispenser with short siphon

Illustration shows DOS K 60



DOS module G 60

- For use on G 7883, G 7893 and G 7835 CD
- For liquid alkaline detergent
- Peristaltic pump, adjustable via machine controls
- Siphon (333 mm) with magnetic float switch for level-fill indicator for 5 and 10 l containers
- Conversion kit (No. 5 45 80 30) with long siphon tube (10–30 l container) available from Spares

DOS G 60/1 dispenser module

- For use on G 7883, G 7893 and G 7835 CD
- Features as per DOS G 60, but with short siphon (200 mm) for 5 l containers

DOS K 60 dispenser module

- For use on G 7883 and G 7893
- For liquid alkaline detergent
- Peristaltic pump, adjustable via machine controls
- Integrated dispenser monitoring function ensuring high level of process security in compliance with EN ISO 15883
- Siphon (333 mm) with magnetic float switch for level-fill indicator for 5 and 10 l containers
- Conversion kit (No. 5 45 80 30) with long siphon tube (10–30 l container) available from Spares

DOS K 60/1 dispenser module

- For use on G 7883 and G 7893
- Features as per DOS K 60, but with short siphon tube (200 mm) for 5 l container

DOS module G 10

- For G 7835 CD
- For liquid acidic products
- Features as per DOS G 60

DOS 2

- For G 7836 CD
- For liquid acidic products (surfactant/neutralising agent)
- Bellows-type dispenser pump, retrofittable by Service

DOS 4

- For G 7836 CD
- For liquid products (disinfectants/alkaline detergents)
- Bellows-type dispenser pump, retrofittable by Service

Accessories for reprocessing with fully demineralised water



Illustration shows washer-disinfector with RO-190 M2 unit



Single-source supplier

Water quality plays a key role in instrument reprocessing. Raw water contains salts and minerals which can result in deposits on the load and on machine surfaces. Fully demineralised water is instrumental in preventing instrument corrosion. In installations requiring large volumes of water, reverse osmosis installations offer an economical alternative to demineralisation cartridges (cf. Chart on Page 41). The use of demineralised water can increase the economic efficiency of washer-disinfectors. Filtration protects against deposits likely to damage the machine, prevents downtimes and repairs and reduces detergent costs.

The Miele range now includes the RO-190 M1 and RO-190 M2 reverse osmosis systems from VEOLIA.



RO-190 M2 reverse osmosis system

- For a continuous supply of demineralised water
- Throughput: max. permeate capacity 190 l/h
- **Reverse osmosis system in stainless-steel plinth with door and floor tray**
Installation of 2 x 5 l supply containers in plinth
- 2 status LEDs (conductivity/throughflow)
- Max. yield approx. 50%
Salt filtration rate 96–98%
Water quality approx. 5–100 $\mu\text{S}/\text{cm}$ (dependent on raw water supply, typically 5–20 $\mu\text{S}/\text{cm}$)
Water connection to RO 3/4"
Permeate outlet 3/4"
Concentrate outlet 8 mm water hose
Water supply pressure 2–6 bar
Electrical connection 230 V/50 Hz
Rated load 1 kW, fuse rating 10 A indicators
Electricity consumption: 0.6 kW/h*
- Cold water max. 28°C
max. raw water hardness 30°dGH, 15°dKH (carbonate hardness)
- Rehingeable door
- External dimensions: H 520, W 600, D 560 mm

RO-190 M2 reverse osmosis system

- For a continuous supply of demineralised water
- Throughput: max. permeate capacity 190 l/h
- **Stand-alone solutions for installation in neighbouring unit**
- Stainless-steel panelling
- External dimensions: H 380, W 543, D 302 mm
- Further features and technical data as per RO-160 M2

Optional for RO-190 M2 and RO-190 M1 (VEOLIA accessory list)

- Installation of a pre-filter
- Additional connection, e.g. for connection of autoclave or water dispenser tap
- Pressure tank to store demineralised water
- Connection to water softener

Indicator lights

●	✓	Status: Ready or Stand by
●	⚠	Conductivity and throughflow indicators: Fault

Accessories for reprocessing with fully demineralised water



G 7895/1 Aqua Purificator

- For use on G 7883 and G 7893
- Housing unit for two E 310 or E 318 demineralisation cartridges
- Integrated conductivity meter
- Generally recommended quality for the final rinse <math>< 15 \mu\text{S}/\text{cm}</math>
- H 850 (820), W 300, D 600 mm
- Freestanding unit, can be built under
- Outer panelling in stainless steel or white
- Electrical connection AC 230 V 50 Hz
- Water connection:
 - 1 x cold water, 3/4" threaded union for connection of cartridge (hose approx. 1.2 m long)
 - 1 x connection of cartridge to machine with 3/4" threaded union (approx. 1.2 m long), 2.5–10 bar flow pressure to cartridge (pressure loss approx. 1 bar per cartridge)



E 310 water demineralisation cartridge, pre-charged

- Pressure-proof stainless-steel cartridge
- H 570, \varnothing 240 mm
- Complete with vent and pressure relief valve
- Contains 20 l of reusable mixed resin

Delivery capacity in litres depends on the salt content of the raw water and the max. acceptable conductivity.

Conductivity levels

	5 $\mu\text{S}/\text{cm}$	10 $\mu\text{S}/\text{cm}$
5°dH	4250	4500
10° dH	2125	2250
15°dH	1420	1500
20°dH	1070	1125
25°dH	850	950
30°dH	710	750

The information given in this chart is intended only as a guide.

E 318 water demineralisation cartridge, empty

- Charged with 20 l of single-use resin

E 315 disposable resin

- 20 l homogenous, mixed-bed resins for E 318
- Box with two 10 l bags, vacuum-packed in plastic sacks
- Replacement filter bag

E 316 refill set

- Plastic barrel with lid and funnel
- For 30 l disposable resin



LWM Module C conductivity meter

- For E 310/E 318 water demineralisation cartridges
- H 118, W 235, D 110 mm
- Electrical connection AC 230 V 50 Hz
- 2 hoses, approx. 1.9 m, 3/4" threaded union
- Integrated conductivity meter
 - 0–20 $\mu\text{S}/\text{cm}$
 - 1.5 $\mu\text{S}/\text{cm}$ = Tri-distilled water
 - 2.5 $\mu\text{S}/\text{cm}$ = Bi-distilled water
 - 20.0 $\mu\text{S}/\text{cm}$ = Single-distilled water

Demineralised water cartridge v. reverse osmosis



E 313 wall valve (above)

- For manual delivery of demineralised water
- Pressure hose approx. 1.5 m, pressure-proof to 10 bar

E 314 cabinet mounted valve (below)

- For manual delivery of demineralised water
- Pressure hose approx. 1.5 m, pressure-proof to 10 bar

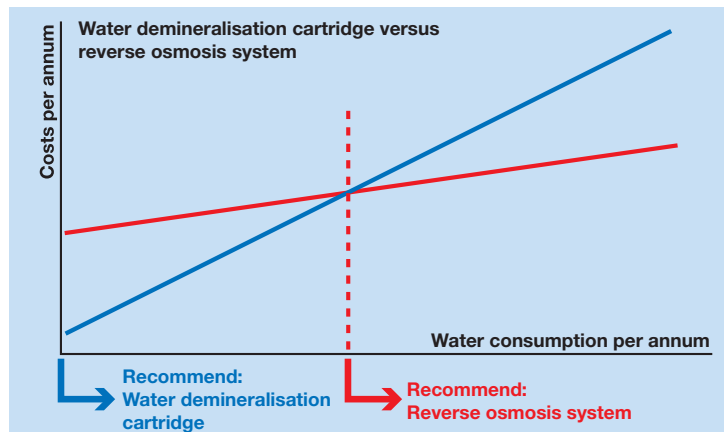

Demineralised water cartridge v. reverse osmosis

To protect instruments, Miele recommends the use of fully demineralised water in the final rinse cycle. Miele offers both water demineralisation cartridges and reverse osmosis systems. The relative benefits of the two systems depend largely on the number of washing and disinfecting programmes run per day. In general, the higher the requirements, the greater the likelihood of a reverse osmosis system being more economical than demineralised water cartridges.

Accessories – Demineralised water



PG 8597 Aqua Soft system, twin-tank water softener

- For continuous supply of softened water for supply hardness ranges of up to approx. 40°d (7.2 mmol/l)
- H 570, W 360, D 360 mm
- Weight (excl. salt) approx. 30 kg
- Freestanding unit on castors. Filled from top.
- Plastic housing unit
- Throughput: Constant supply 19 l/min, max. flow 30 l/min
- Level controlled twin-tank system
- No electrical connection required
- Equipped with 2 x 4.5 l resin-filled containers and 1 container for 20 kg of salt
- Water connection:
 - 2 pressure hoses, approx. 1.5 m, 3/4" threaded union
 - 1 x cold or hot water, max. 70°C, min. supply flow pressure 1 bar, max. static pressure 8 bar
 - 2.5 bar minimum flow pressure on machines without water softener, 3.5 bar min. flow pressure on machines with water softener

- 1 x connection between system and machine
- 2 hoses downstream, approx. 1.5 m (DN 8 for reactivated water and overflow, odour trap and non-return valve to be provided on site.
- Water consumption 19 l/reactivation cycle



Technical data

G 7883, G 7893, G 7883 CD

Washer-disinfectors	G 7883	G 7893	G 7883 CD
Frontloading unit with bottom-hinged door, excl. baskets	•	•	•
Freestanding unit with lid, can be built under	•	•	–
Built-under/freestanding unit with lid	–	–	•
Freshwater system, max. temperature 93°C	•	•	•
Circulation pump [Qmax. l/min]	400	400	400
Controls/programmes			
MULTITRONIC Novo plus/10 programmes	•	•	•
Electric door lock	•	•	•
Buzzer, acoustic signal at end of programme	•	•	•
Programme continuation in event of power outage	•	•	•
Serial interface for process documentation (SST)	• (depending on model)	• (depending on model)	•
Water supply connection			
1 x cold water, 0.5–10 bar flow pressure (50–1000 kPa)	•	•	•
1 x cold water for steam condenser, 0.5–10 bar flow pressure (50–1000 kPa)	–	–	•
1 x demineralised water, 0.5–10 bar flow pressure (50–1000 kPa)	• (only units without ADP)	• (only units without ADP)	• (only units without ADP)
1 x hot water, 0.5–10 bar flow pressure (50–1000 kPa)	•	•	•
No. of inlet hoses 1/2" with 3/4" threaded union, length approx. 1.7 m	3	3	4
Drain pump DN 22, head height 100 cm	•	•	•
Steam condenser water drain (DN 22)	–	–	•
Waterproof system (WPS)	•	•	•
Electrical connection, supply lead approx. 1.7 m, 5 x 2.5 mm²			
3 N AC 400 V 50 Hz	•	•	•
Heating [kW]	9.0	9.0	9.0
Circulation pump [kW]	0.7	0.7	0.7
Total rated load [kW]	9.7	9.7	9.7
Fuse rating [A]	3 x 16	3 x 16	3 x 16
Electrical connection for UK only			
1 N AC 230 V 50 Hz, connection cable ca. 1.7 m, 3 x 4.0 mm ²	•	•	•
Heater rating [kW]	6	6	6
Circulation pump [kW]	0.7	0.7	0.7
Total connected load [kW]	6.7	6.7	6.7
Fuse rating [A]	30	30	30
3 N AC 400 V 50 Hz, connection cable ca. 1.7 m, 5 x 2.5 mm ²	•	•	•
Heater rating [kW]	8.5	8.5	8.5
Circulation pump [kW]	0.7	0.7	0.7
Total connected load [kW]	9.2	9.2	9.2
Fuse rating [A]	3 x 16	3 x 16	3 x 16
Connection options			
DOS K 60 or DOS K 60/1 for liquid detergents/chemicals	1	1	–

G 7883/G 7893

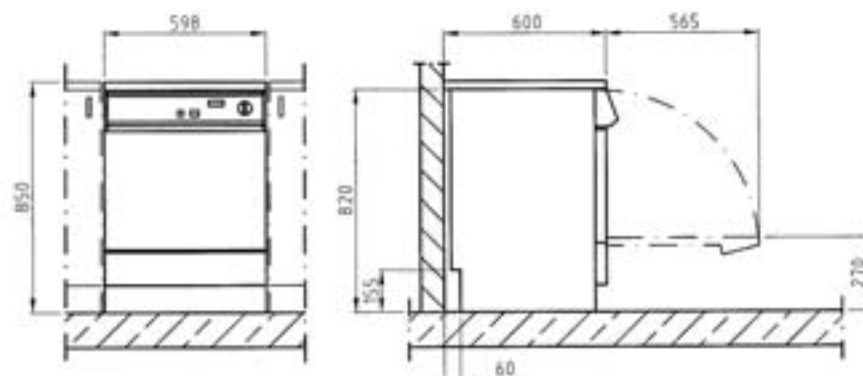

Washer-disinfectors	G 7883	G 7893	G 7883 CD
Dispenser systems			
1 door dispenser for powder detergent	•	•	•
1 door dispenser for liquid surfactant	•	•	•
1 DOS 10/30 dispenser pump for liquid acidic agents	•	•	•
1 DOS 60/30 dispenser pump for liquid detergent	–	–	•
Drawer with 2 supply containers, 5 l each	–	–	•
Water softener			
for cold and hot water to max 70°C, Monobloc	•	•	•
Steam condenser			
Heat exchanger	• (depending on model)	–	–
Aerosol	–	•	•
Drying unit/Radial fan			
Fan motor [kW]	–	0.3	0.3
Heater bank [kW]	–	1.8	1.8
Total rated load [kW]	–	2.1	2.1
Air throughput [m³/h]	–	63.4	55
Temperature selection in 1° increments [°C]	–	50–99	50–99
Time selection in 1-minute increments [min]	–	1–99	1–99
Pre-filter EU 4, filter rating >95%, filter life 100 h	–	–	•
Particulate filter/HEPA filter H 12	–	•	–
Filtration rate >99.5% (DIN EN 1822)/life cycle 100 h			
Particulate filter/HEPA filter H 13		–	•
Filtration rate >99.992% (DIN EN 1822)/life cycle 500 h			
Dimensions, weight			
External dimensions H/W/D (excl. lid H 820 mm) [mm]	850/600/600	850/600/600	820/900/700
Cabinet dimensions H/W/D [mm]	500/535/0=473 U=516*	500/535/0=473 U=516*	500/535/0=473 U=516*
Weight [kg]	74	78	101
External casing options			
White casing, front with decor frame for decor panel (DER)	•	–	–
Door: H 441–442/W 585–586/Thickness 1 mm, Service panel: H 116.5–117.5/W 585–586/Thickness 1 mm			
White casing, laminate lid (AW)	•	–	–
Stainless steel (AE)	•	•	•
Test certificates			
VDE, VDE-EMC, IP X1	•	•	•
MDD CE 0366	–	–	–
DVGW	•	–	•
WRAS	•	•	•
*O = Upper basket, U = Lower basket/• = standard, - = not available			

G 7883 CD

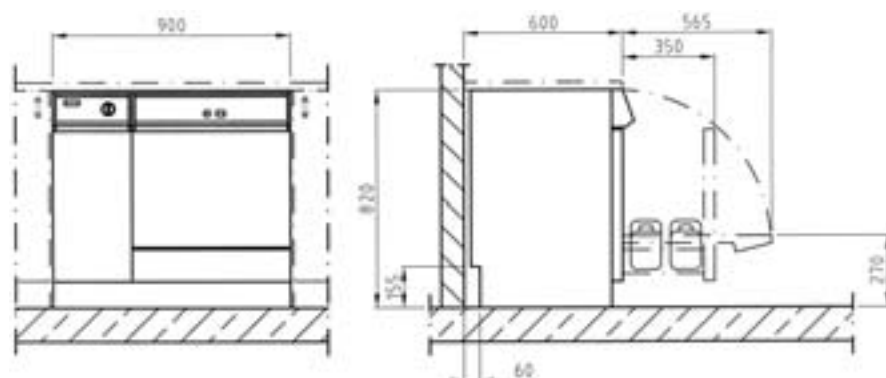

Technical data

G 7835 CD, G 7836 CD

Washer-disinfectors	G 7835 CD	G 7836 CD
Front-loading unit with bottom-hinged door, excl. baskets	•	•
Built-under/freestanding unit with lid	•	–
Freestanding unit with lid	–	•
Freshwater system, max. temperature 93°C	•	•
Circulation pump [Qmax. l/min]	400	600
Controls/programmes		
Freely programmable PROFITRONIC controls	•	•
Electric door lock	•	•
Peak-load negotiation	•	•
Serial interface for process documentation	•	•
Magnetic strip for automatic mobile unit recognition	•	•
Water supply connection		
1 x cold water, 0.5–10 bar flow pressure (50–1000 kPa)	•	•
1 x cold water for steam condenser, 0.5–10 bar flow pressure (50–1000 kPa)	•	•
1 x hot water, 0.5–10 bar flow pressure (50–1000 kPa)	•	•
1 x demineralised water, 0.5–10 bar flow pressure (50–1000 kPa)	•	•
Feed pump for demineralised water (depending on model)	•	•
4 inlet hoses 1/2" with 3/4" threaded union, length approx. 1.7 m	•	•
Drain pump DN 22, head height 100 cm	•	•
Steam condenser water drain (DN 22)	•	•
Waterproof system (WPS)	•	•
Electrical connection		
3 N AC 400 V 50 Hz, supply lead approx. 1.7 m, 5 x 2.5 mm ²	•	•
Heating [kW]	9.0	9.0
Circulation pump [kW]	0.7	1.2
Total rated load [kW]	9.7	10.2
Fuse rating [A]	3 x 16	3 x 16
Dispenser systems		
1 dispenser pump for liquid acidic agents	• (peristaltic pump)	• (bellows-type pump)
1 dispenser pump for liquid detergent	• (peristaltic pump)	• (bellows-type pump)
Drawer for 2 x 5 l supply containers	•	–
Drawer for 4 x 5 l supply containers	–	•
Connections		
DOS G 10 dispenser for liquid agents (surfactant)	•	–
DOS G 60 or DOS G 60/1 dispenser for liquid detergent	•	–
DOS 2 dispenser pump for liquid agents (surfactant), Bellows-type pump, retrofittable by Service	–	•
DOS 4 dispenser pump for liquid agents (disinfectant), Bellows-type pump, retrofittable by Service	–	•

G 7835 CD

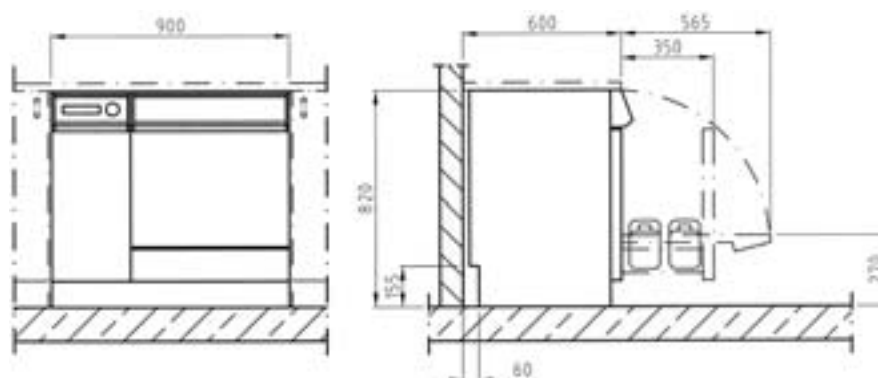

Washer-disinfectors	G 7835 CD	G 7836 CD
Water softener		
for cold and hot water to max 70°C, Monobloc	•	-
for cold and hot water to max 70°C, large-capacity water softener	-	•
Steam condenser		
Aerosol	•	•
Drying unit/Radial fan		
Fan motor [kW]	0.3	0.3
Heater bank [kW]	2.3	2.3
Total rated load [kW]	2.6	2.6
Air throughput [m³/h]	55	55
Temperature selection in 1° increments [°C]	60-115	60-115
Time selection in 1-minute increments [min]	1-240	1-240
Pre-filter EU 4, filter rating > 95%, filter life 100 h	•	•
Particulate filter/HEPA filter H 13, filter rating > 99.992% (DIN EN 1822), filter life 500 h	•	•
Dimensions, weight		
External dimensions H/W/D [mm]	820/900/700	1175/900/700
Cabinet dimensions H/W/D [mm]	500/535/O=473 U=516*	500/535/O=473 U=516*
Weight [kg]	114	192
Outer casing		
Stainless steel (AE)	•	•
Test certificates		
VDE, VDE-EMC, DVGW, MDD CE 0366, IP X1	•	•
*O = Upper basket, U = Lower basket		
• = standard, - = not available		

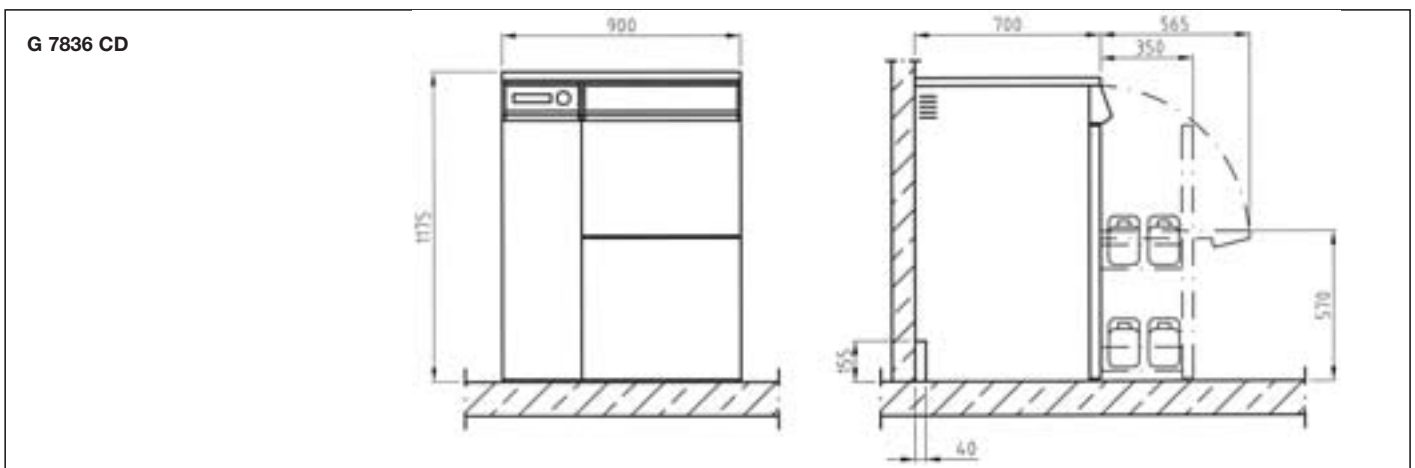

Miele & Cie. KG
Carl-Miele-Straße 29, 33332 Gütersloh
Postfach, 33325 Gütersloh

www.miele-professional.com
info@miele.de

Miele worldwide:

AUSTRALIA
Miele Australia Pty. Ltd.
1 Gilbert Park Drive
Knoxfield, VIC, 3180
Tel. +61(0)3/97 64 71 30
Telefax +61(0)3/97 64 71 49

AUSTRIA
Miele Gesellschaft mbH.
Mielestraße 1
5071 Wals/Salzburg
Tel. +43(0)50 800-81 481
Telefax +43(0)50 800-81 429

BELGIUM
N.V. Miele S.A.
2.5 Mollem 480
Hof te Bollebeeklaan 9
1730 Mollem
Tel. +32(0)2/451.14.11
Telefax +32(0)2/451.14.14

CANADA
Miele Limited
161 Four Valley Drive
Vaughan, ON L4K 4V8
Toll free: (800) 643-5381
Tel. (905) 660-9936
Telefax (905) 532-2290

CHILE
Miele Electrodomésticos Ltda.
Av. Vitacura 3285
Vitacura
Santiago de Chile
Tel. +56 2 2077171
Telefax +56 2 2065676

CHINA
Miele Beijing Rep. Office
3W Suite 512, Oriental Plaza,
1 East Chang An Avenue
Dong Cheng District
Beijing 100738, P.R. China
Tel. +86 10 85151919
Telefax +86 10 85181797

Miele Shanghai Rep. Office
Suite 4105-06, Plaza 66
1266 Nanjing Road West
Shanghai 200040, P.R. China
Tel. +86 21 62884200
Telefax +86 21 62884100

CROATIA
Miele d.o.o.
Buzinski prilaz 32
10000 Zagreb
Tel. +385/1/66 89 000
Telefax +385/1/66 89 090

CZECH REPUBLIC
Miele spol. s.r.o.
Hněvkovského 81B, 61700 Brno
Tel. +42(0)5/4 35 53-1 11
Telefax +42(0)5/4 35 53-1 19

DENMARK
Miele A/S
2600 Glostrup, Erhvervsvej 2
Tel. +45 43 27 11 00
Tel. Salg/Professional
+45 43 27 15 00
Tel. Jylland +45 97 12 70 66
Telefax hovednr. +45 43 27 11 09
Telefax Salg/Professional
+45 43 27 15 09

FINLAND
Miele Oy
Porttikaari 6, 01200 Vantaa
Tel. +358(0)9/87 59 70
Telefax +358(0)9/87 59 72 99

FRANCE
Miele S.A.S.
9 avenue Albert Einstein
93151-Le Blanc-Mesnil (Paris)
Tel. +33(0)1/49 39 34 44
Telefax +33(0)1/49 39 44 37

GERMANY
Miele & Cie. KG
Carl-Miele-Straße 29
33332 Gütersloh
Tel. 0 180 220 21 21 (6 ct)*
Telefax 0 800 225 57 55
*Only in Germany

GREAT BRITAIN
Miele Co. Ltd. Fairacres
Marcham Road, Abingdon
Oxon OX14 1TW
Tel. +44(0)12 35/55 44 55
Telefax +44(0)12 35/55 44 77

GREECE
Miele Hellas GmbH
Mesogion 257
154 51 N. Psychiko-Athen
Tel. national 01/10 6 79 44 44
international 00 30/2/10 6 79 44 44
Telefax 01/10 6 79 42 09
international 00 30/2/10 6 79 42 09

HUNGARY
Miele Kft.
Alsó Törökvész út 2.
1022 Budapest
Tel. +36 (06) 1 8806-400
Telefax +36 (0) 1 8006-402

HONG KONG
Miele Hong Kong Ltd.
AIA Plaza, 24th Floor,
18 Hysan Avenue,
Causeway Bay, Hong Kong
Tel. +852/26101331
Telefax +852/26101013

IRELAND
Miele Ireland Ltd.
Broomhill Road
Tallaght, Dublin 24
Tel. +353(0)1/461 07 10
Telefax +353(0)1/461 07-97

ITALY
Miele Italia S.r.l.
Strada di Circonvallazione, 27
39057 S. Michele-Appiano (BZ)
Tel. +39 04 71/66 61 11
Telefax +39 04 71/66 63 50

JAPAN
Miele Japan Corp.
E Space Tower 11F
3-6 Maruyamacho
Shibuya-ku Tokyo
150-0044 Japan
Tel. +81(3)5784-0030
Telefax +81(3)5784-0035

KOREA
Miele Korea Limited
Miele Haus, 607-10 Yeoksam-dong
Gangnam-gu
Seoul 135-080
Tel. +82 2 3451 9343
Telefax +82 2 3451 9399

LATVIA
Miele SIA
Kr. Valdemāra 21-621
1010 RIGA
Tel. +371 6 7035232
Telefax +371 6 7035252

LUXEMBOURG
Miele s.à r.l.
20, Rue Christophe Plantin
2339 Luxembourg
Tel. +352/4 97 11-25
Telefax +352/4 97 11-39

MEXICO
Miele S.A. de C.V.
Av. Santa Fé 170
German Centre 0-4-2
Col. Lomas de Santa Fé
01210, México, D.F.
Tel. +52/55/85 03 98 70 and
+52/55/85 03 98 73
Telefax +52/55/85 03 98 74

NETHERLANDS
Miele Nederland B.V.
De Limiet 2, 4131 NR Vianen
Tel. +31(0)3 47/37 88 83
Telefax +31(0)3 47/37 84 29

NEW ZEALAND
Miele New Zealand Ltd.
Unit L, 10-20 Sylvia Park Road
Mt. Wellington, 1060 Auckland
Tel. +64(0)9/573 1269
Telefax +64(0)9/573 1268

NORWAY
Miele AS
Løxaveien 13
1351 Rud
Tel. +47/67 17 31 00
Telefax +47/67 17 31 10

POLAND
Miele Sp. z. o. o.
ul. Gotarda 9
02-683 Warszawa
Tel. +48/022/5 48 40 00
Telefax +48/022/5 48 40 10

PORTUGAL
Miele Portuguesa, Lda.
Av. do Forte, 5
2790-073 Carnaxide
Tel. +351/21/42 48-100
Telefax +351/21/42 48-109

RUSSIA
000 Miele CIS
Leningradskij Prospekt, 39A
125167 Moscow
Tel. +7(8)495 745-8992
Telefax +7(8)495 745-8680

SINGAPORE
Miele Pte. Ltd.
163 Penang Road #04-02/03
Winsland House II
Singapore 238463
Tel. +65/67 35 11 91
Telefax +65/67 35 11 61

SLOVAKIA
Miele spol. s. r. o.
Plynárenská 1
82109 Bratislava
Tel. +421/2/53 63 37 37
Telefax +421/2/53 63 37 46

SLOVENIA
Miele d.o.o.
Brnčičeva 41 g
1000 Ljubjana
Tel. +386 (0)1563 44-80
Telefax +386 (0) 1563 44-90

SOUTH AFRICA
Miele SA (Pty) Ltd.
63 Peter Place
Bryanston 2194
Tel. +27(0)11/5 48-19 00
Telefax +27(0)11/5 48-19 35

SPAIN
Miele S.A.
Carretera de Fuencarral, 20
28108 Alcobendas (Madrid)
Tel. +34/91/6 23 20 00
Telefax +34/91/6 62 02 66

SWEDEN
Miele AB
Industrivägen 20
Box 1397
171 27 Solna
Tel. +46(0)8/5 62 29-000
Telefax +46(0)8/5 62 29-209

SWITZERLAND
Miele AG
Limmatstr. 4
8957 Spreitenbach
Tel. +41(0)56/4 17 20 00
Telefax +41(0)56/4 17-24 69

TURKEY
Miele Elektrikli Aletler
Diş. Tic. ve Paz. Ltd. Şti.
Güvercin Sokak No. 10
34330 Levent-Istanbul
Tel. +90/2 12/3 25 84 40
Telefax +90/2 12/3 25 84 49

UKRAINE
Miele LLC
Spaskaya St., 30 A
04070 Kiev
Tel. +38 (8)044 4960300
Telefax +38 (8)044 4942285

UNITED ARAB EMIRATES
Miele Appliances Ltd.
Gold & Diamond Park
Sheikh Zayed Road
Building No. 6,
Offices Nos. 214-220
Dubai
Tel. +971 4 3418444
Telefax +971 4 3418852

USA
Miele, Inc.
9 Independence Way
Princeton, NJ 08540
Tel. 001-800/843 72 31
Telefax 001-609/419 42 41

OTHER COUNTRIES:
Sales International
Miele & Cie. KG
Carl-Miele-Straße 29
33332 Gütersloh
Tel. +49(0)52 41-89 15 07
Telefax +49(0)52 41-89 15 00

Free Manuals Download Website

<http://myh66.com>

<http://usermanuals.us>

<http://www.somanuals.com>

<http://www.4manuals.cc>

<http://www.manual-lib.com>

<http://www.404manual.com>

<http://www.luxmanual.com>

<http://aubethermostatmanual.com>

Golf course search by state

<http://golfingnear.com>

Email search by domain

<http://emailbydomain.com>

Auto manuals search

<http://auto.somanuals.com>

TV manuals search

<http://tv.somanuals.com>