

Operating instructions

Commercial dishwasher
G 7855

To avoid the risk of accidents or damage to the machine it is **essential** to read these operating instructions before it is installed, commissioned and used for the first time.



M.-Nr. 05 234 481

Contents

Description of the machine	3
Guide to the machine	4
Warning and Safety instructions	6
Caring for the environment	10
Before using for the first time	11
Opening and closing the door	12
Water softener	13
Setting the water softener	15
Filling the salt reservoir	16
Salt indicator	17
Loading the machine	18
Loading the machine	18
Adjusting the top basket	21
Items not suitable for dishwashers	21
Adding rinsing agent	22
Setting the dosage	24
Adding cleaning agent	25
Selecting a programme	27
Programme chart	28
Operation	30
Switching on	30
Starting a programme	30
Changing a programme	31
Selecting an additional function	31
Programme sequence indicators	31
Switching off	31
To cancel a programme	32
Programming special functions	33
Cleaning and care	40
Correcting minor faults	44
Customer service	45
Installation	46
Electrical connection	48
Plumbing	49
Technical data	51

Description of the machine

This Miele machine is a front-loading commercial dishwasher, with very short batch times. It is especially suitable for use in cafes, fast food outlets, restaurants, guest houses etc. It operates on the freshwater system and is equipped with a water softener as standard.

Guide to the machine

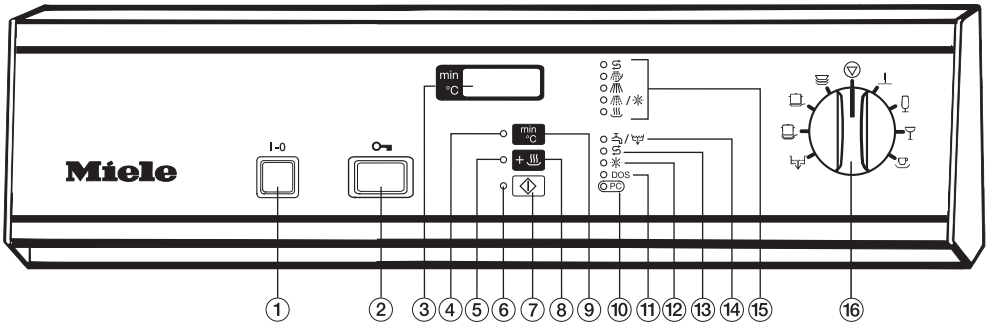

- ① On/Off button (I-O)
- ② Door release button
- ③ Display
- ④ Delay start indicator light (see Programming special functions)
- ⑤ Drying indicator light
- ⑥ Programme start indicator light
- ⑦ Start button
- ⑧ Drying button
- ⑨ Button to change between the current temperature and elapsed time in the display
- ⑩ Optical interface (for Service Technician use only)
- ⑪ Add liquid cleaning agent indicator light (only applies to machine fitted with an optional external DOS module)
- ⑫ Add rinsing agent indicator light
- ⑬ Add salt indicator light
- ⑭ Water inlet / Drain indicator light
- ⑮ Programme sequence indicators
- ⑯ Programme selector

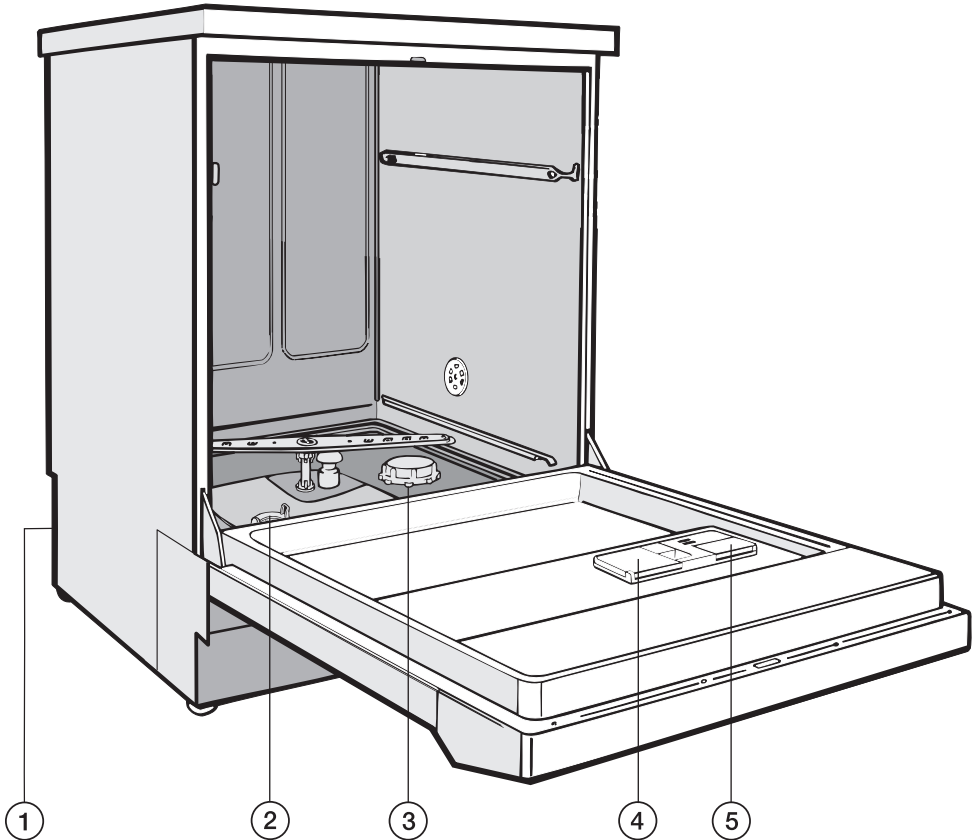

① Connection for DOS module
(optional dispenser pump for liquid
cleaning agent) at the rear of the
machine

② Filter combination

③ Salt reservoir
(for the water softener)

④ Dispenser for powder cleaning agent

⑤ Rinsing agent reservoir
(with dosage selector)

Warning and Safety instructions

This machine complies with all relevant local and national safety requirements. Incorrect use can lead to personal injury and damage to property.

Read the operating instructions carefully before starting to use this machine. This way you will avoid the risk of accidents and damage to the machine.

Keep these instructions in a safe place for reference, and pass them on to any future user.

Correct use

■ This machine is designed for commercial use only, as described in these Operating Instructions. Alterations to the machine, or using it for purposes other than those for which it was designed, are unauthorised and could cause harm. The manufacturer cannot be held liable for damage caused by improper or incorrect use of the machine.

■ This equipment may only be installed in mobile installations such as ships, oil rigs etc. if a risk assessment of the installation has been carried out by a suitably qualified engineer.

Please pay attention to the following notes to avoid injury and damage.

■ This machine should be commissioned and then maintained by a Miele authorised and trained service technician or other suitably qualified and competent approved person. Repairs and other work by unqualified persons could be dangerous.

■ Do not install the machine in an area where there is any danger of explosion or of freezing conditions.

■ The electrical safety of this machine can only be guaranteed if connected to a correctly installed earthing system on site. It is imperative that this basic safety requirement is tested regularly and, where there is any doubt, the electrical wiring system on site should be inspected by a qualified electrician.

The manufacturer cannot be held liable for damage or injury caused by the lack of or inadequacy of an effective earthing system (e.g. electric shock).

■ A damaged machine is dangerous. Switch off at the mains immediately and call the Miele Service Department or an authorised and trained Miele Service Dealer or other suitably qualified and competent approved person.

Warning and Safety instructions

■ Personnel operating the machine should be trained regularly.

Untrained personnel should not be allowed access to the machine or its controls.

■ This machine is not a toy! Do not allow children to play in or around it, or to operate it. There is a danger they could injure themselves, or get into the machine and lock themselves in.

■ Take great care when handling liquid agents and additives. These may contain irritant or corrosive ingredients. Do not use organic solvents as these could cause an explosion.

Follow all relevant safety procedures carefully. Wear protective gloves and goggles. With all chemical agents, the manufacturer's safety conditions must be observed.

■ Avoid inhalation of powder cleaners. They can cause burning in the mouth and throat if swallowed, and can inhibit breathing.

■ The water in the machine must not be used as drinking water.

■ Do not sit or lean on an open door. The machine could tip up and be damaged, or cause an injury.

■ Be careful when sorting items with sharp pointed ends and positioning them in the machine that you do not hurt yourself or create a danger for others. Sharp knives etc. should be placed in the baskets with the pointed end facing downwards.

■ When using this machine in the higher temperature ranges be

especially careful not to scald or burn yourself when opening the door. Baskets and inserts must be allowed to cool down before they are unloaded. Any water remaining in containers could still be very hot. Empty them into the wash cabinet before taking them out.

■ Do not touch the heating elements if you open the door during or directly after the end of a programme: you could burn yourself. They remain hot for some time after the end of the programme.

■ Never clean the machine or near vicinity with a water hose or a high pressure hose.

■ Before any maintenance or repair work is carried out, the machine must be disconnected from the mains supply by switching off at the mains isolator or withdrawing the mains fuse.

The following points should be observed to assist in maintaining quality standards, to protect users, and to avoid damage to the machine and items being cleaned.

■ Only use Miele approved cleaning agents in this machine. Use of unsuitable cleaning agents could adversely affect the components of the machine as well as items being cleaned.

■ Foam can have an adverse effect on the cleaning process. Only use low-foaming cleaning agents which have been approved by Miele. Some types of soiling can also cause foaming to occur.

Warning and Safety instructions

Where a chemical additive is recommended on technical application grounds (e.g. a cleaning agent), this does not imply that the manufacturer of the machine accepts liability for the effect of the chemical on the items being cleaned. Please be aware that changes in formulation, storage conditions etc. which may not be publicised by the chemical manufacturer, can have a negative effect on the cleaning result.

When using cleaning agents and special application products, it is essential that the manufacturer's instructions are followed. Only use such products for the purpose and in the situation specified to avoid such dangers as chemical reactions and material damage.

The machine is designed for operation with water and additive cleaning agents only. Organic solvents must not be used in this machine, as there is the danger under certain circumstances of fire or explosion. (Although this is not the case with all organic solvents, other problems could arise with their use, for example damage to rubber and synthetic materials).

In critical applications where very stringent requirements have to be met, it is strongly recommended that all the relevant factors for the process, such as cleaning agents, water quality etc., are discussed with the Miele Application Technology specialists.

If cleaning and rinsing results are subject to particularly stringent requirements (e.g. chemical analysis, specialised industrial processes etc.), a regular quality control test must be carried out by the user to ensure that required standards of cleanliness are being achieved.

The special inserts should only be used for their specific application.

Empty any containers or utensils before arranging them in the machine.

Do not allow any remains of acids or solvents, and in particular hydrochloric acid or chloride solutions, to get into the wash cabinet. Similarly avoid any materials with a corrosive effect.

The presence of solvents exceeding trace levels should not be present in soiling (especially those in hazard class A1).

To avoid any corrosion damage, ensure that solutions or steam containing hydrochloric acid do not come into contact with the steel outer casing of the machine.

Please follow the advice on installation in these instructions and the separate Installation Instructions.

Warning and Safety instructions

Using accessories

■ Only use genuine Miele accessories with this machine. Consult Miele on the type and application of such equipment.

Disposal of your old machine

■ Before disposing of your old machine first make it unusable. Disconnect from the mains, cut off the cable near the machine and any plug from the cable.

For environmental and safety reasons ensure the machine is completely drained of any residual water and cleaning agent. (Observe safety regulations and wear safety goggles and gloves).

Make the door lock inoperative, so that children cannot accidentally shut themselves in. Then make appropriate arrangements for the safe disposal of the machine.

The manufacturer cannot be held liable for damage caused by non-compliance with these Warning and Safety instructions.

Caring for the environment

Disposal of the packing material

The transport and protective packing has been selected from materials which are environmentally friendly for disposal and can normally be recycled.

Ensure that any plastic wrappings, bags etc. are disposed of safely and kept out of the reach of babies and young children. Danger of suffocation.

Rather than just throwing these materials away, please ensure that they are recycled.

Disposal of your old appliance or machine

Electrical and electronic appliances / machines often contain materials which, if handled or disposed of incorrectly, could be potentially hazardous to human health and to the environment. They are, however, essential for the correct functioning of your appliance or machine. Please do not therefore dispose of your old machine or appliance with your household waste.

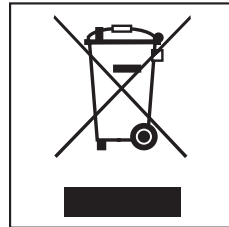

Please dispose of it at your local community waste collection / recycling centre and ensure that it presents no danger to children while being stored for disposal.

It should be unplugged or disconnected from the mains electricity supply by a competent person. The plug must be rendered useless and the cable cut off directly behind it to prevent misuse. See the "Warning and Safety" section of this booklet for further details.

Before using for the first time

Before using for the first time please pay special attention to the following points.

Detailed information on these points can be found in the relevant sections of these Operating Instructions.

Set the water softener unit

The water softener unit must be set for the water hardness level in your area.

The salt reservoir also has to be filled, first with water and then with reactivation salt.

 Filling the salt reservoir with cleaning agent by mistake will cause serious damage to the water softener. Please check every time before refilling that the package contains reactivation salt.

Add rinsing agent

 Inadvertently filling the reservoir for rinsing agent with cleaning agent (including liquid cleaning agents and washing up liquid) will cause serious damage to the reservoir.

Only use designated cleaning agents for special applications.

Do not use cleaning agents formulated for use in domestic dishwashers.

Load the machine carefully

Arrange the load so that water will come into contact with all surfaces. Concealed surfaces will not be cleaned.

The spray arms must not be blocked by any items.

Add cleaning agent

Follow the cleaning agent manufacturer's recommendations on dosage.

The amount required will depend on the type of cleaning agent and the programme chosen.

Make sure you read the notes on dosing given in the programme chart.

Cleaning results may vary from brand to brand. If you are not satisfied with the results from one brand, try another quality brand before contacting Miele for advice.

The filter combination at the base of the wash cabinet and the spray arms must be kept clean.

Regular checking and cleaning is essential.

Opening and closing the door

Open the door

- Press the door button in as far as it will go, and at the same time, grip the handle and open the door.

The door should only be opened during operation for emergencies, e.g. if articles are knocking together or if a programme fault is indicated in the display (see "Cancelling a programme").

 Do not touch the heating elements if you open the door during or directly after the end of a programme: you could burn yourself. The elements remain hot for some time after the end of the programme.

To close the door

- Lift the door upwards and push until it clicks shut. Do not press the door release button whilst shutting the door.

The water needs to be softened to avoid calcium deposits building up on utensils and in the machine itself.

To ensure a steady supply of soft water, the water softener unit must always be:

1. correctly programmed and
2. the salt reservoir must be filled.
If the water hardness level is below 4 °d - German scale (0.7 mmol/l), the reservoir does not need to be filled with reactivation salt.

The machine is set at the factory for a water hardness level of 19 °d (3.4 mmol/l).

If the water supply is harder or softer than this (including below 4 °d or 0.7 mmol/l), the factory setting will need to be changed following the instructions in Setting the water softener. See chart on the next page for settings.

Your local water authority will advise you on the water hardness in your area.

For fluctuating levels e.g. 8 - 17 °d (1.4 - 3.1 mmol/l) set the water softener to the highest setting. In this example to 17 °d (3.1 mmol/l).

Important

The built-in water softener has settings from 1 °d - 60 °d (0.2 - 10.8 mmol/l).

For future servicing it is useful to make a note of your water hardness level.

- Enter your water hardness level here:
_____ °d / mmol/l

Water softener

Table of settings

°d (German scale)	mmol/l	°f	Setting
1	0.2	2	1
2	0.4	4	2
3	0.5	5	3
4	0.7	7	4
5	0.9	9	5
6	1.1	11	6
7	1.3	13	7
8	1.4	14	8
9	1.6	16	9
10	1.8	18	10
11	2.0	20	11
12	2.2	22	12
13	2.3	23	13
14	2.5	25	14
15	2.7	27	15
16	2.9	29	16
17	3.1	31	17
18	3.2	32	18
19	3.4	34	19 *)
20	3.6	36	20
21	3.8	38	21
22	4.0	40	22
23	4.1	41	23
24	4.3	43	24
25	4.5	45	25
26	4.7	47	26
27	4.9	49	27
28	5.0	50	28
29	5.2	52	29
30	5.4	54	30
31	5.6	56	31
32	5.8	58	32
33	5.9	59	33
34	6.1	61	34
35	6.3	63	35
36	6.5	65	36 **)
37	6.7	67	37
38	6.8	68	38
39	7.0	70	39
40	7.2	72	40
41	7.4	74	41
42	7.6	76	42
43	7.7	77	43
44	7.9	79	44
45	8.1	81	45









°d / mmol/l	mmol/l	°f	Setting
46	8.3	83	46
47	8.5	85	47
48	8.6	86	48
49	8.8	88	49
50	9.0	90	50
51	9.2	92	51
52	9.4	94	52
53	9.5	95	53
54	9.7	97	54
55	9.9	99	55
56	10.1	101	56
57	10.3	103	57
58	10.4	104	58
59	10.6	106	59
60	10.8	108	60

*) factory setting

**) 1-36 only for U.K.

Machines without a water softener are set to 0 at the factory. This setting of 0 must not be changed on these machines.

Setting the water softener

- Switch the machine off.
- Turn the programme selector to the STOP position .
- Press  and  at the same time, hold them in and, whilst doing so, switch the machine on with the **I-O** button.
The current programme status "P.." will show in the display.
The indicator light  /  will come on.
- Press  once. E01 for programming level 1 will appear in the display.
- Turn the programme selector six switch positions clockwise (6 o'clock position).
The number 19 will appear in the display (the factory water hardness setting in °d, equivalent to 3.4 mmol/l).
- Press  as many times as is necessary, or hold it in until the required value (hardness level in °d) appears in the display.
Once the number 60 (36 only for U.K.) has been reached, the counter will begin again at 0.
- Press the  button. SP appears.
- Press  again. The setting will now be stored in the memory. The display clears.
- The machine is now ready for operation.

Water softener

Filling the salt reservoir

Please only use special coarse grained reactivation salt with granules of approx. 1-4 mm. Do not use other types of salt, e.g. table salt, agricultural or gritting salt. These could contain components which are insoluble in water which could result in damage to the water softener. If in doubt consult your Miele Professional Department.

The salt reservoir holds approx. 2.5 kg of salt.

 Inadvertently filling the salt reservoir with cleaning agent will damage the water softener.

Before filling the salt reservoir make sure that you have picked up the right packet of reactivation salt.

- Remove the bottom basket from the machine.
- Unscrew the salt reservoir cap.

Before filling the salt reservoir with reactivation salt for the first time, fill it with approx. 2.5 litres of water.

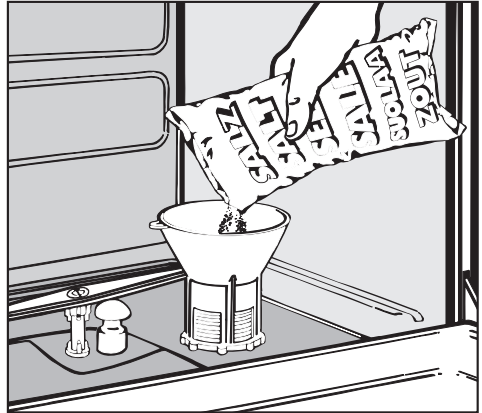

- Place the funnel provided in place.
- Fill carefully with salt. As it is filled, displaced water will run out).
- Wipe any residual salt off the screw threads on the socket.
- Screw the cap on firmly.
- Immediately after this: Run the PRE-RINSE programme ↓ to remove any traces of salt from the cabinet.

Important: If after starting the PRE-RINSE programme ↓ the machine does not start for a few minutes this is not a fault. The water softener is being reactivated.

Salt indicator

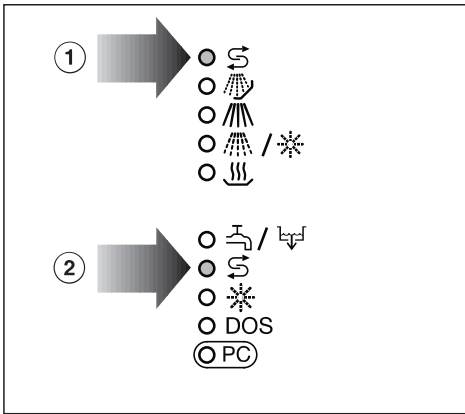

When the salt reservoir is empty the S indicator light ② comes on to remind you to fill the reservoir.

Reactivation takes place automatically during a programme.

The programme sequence indicator light S ① lights up whilst this is happening.

Loading the machine

Loading the machine

Preparing the load

- Empty all containers before loading into the machine.

 Ensure that no acid or solvent residues, especially hydrochloric acid or chlorides, get into the wash cabinet.

Please note

- Load items so that water will come into contact with all surfaces. This ensures that they will be properly cleaned.
- Do not place items to be cleaned inside other pieces where they may be concealed.
- Hollow vessels such as cups, glasses, pots etc. should be inverted and placed in the correct inserts. The water must be able to access them unhindered.
- Deep-sided items should be placed at an angle so that water can run off them unhindered.
- Tall, narrow, hollow items should be placed in the centre of the baskets to ensure better water coverage.
- Small pieces should be placed on the cup racks in the upper basket. Do not obscure them by larger items below. Cups should be on the lower rack and bowls on the top rack so that water reaches all items.
- The water duct for the spray arm in the middle of the upper basket must not be obstructed.
- The spray arms must not be blocked by items which are too tall or which hang down in their path. If necessary, manually rotate the arms to test.

Use the upper basket for:

- Small lightweight, delicate items such as cups, saucers, glasses, dessert bowls etc., as well as for lightweight thermally stable plastic items.

Use the bottom basket for:

- Larger and heavier items such as plates, serving platters, saucepans, bowls etc. Glasses may only be cleaned in the bottom basket if it is fitted with a special glassware insert or if there is a special bottom basket.

Cutlery

- Unsorted cutlery should be placed in the cutlery holders with the handles facing downwards. However, to avoid the risk of injury, sharp knives etc. should be placed with the pointed end facing downwards.

Select baskets and inserts which are appropriate for the application.

See examples on the following pages.

Loading the machine

Loading examples:

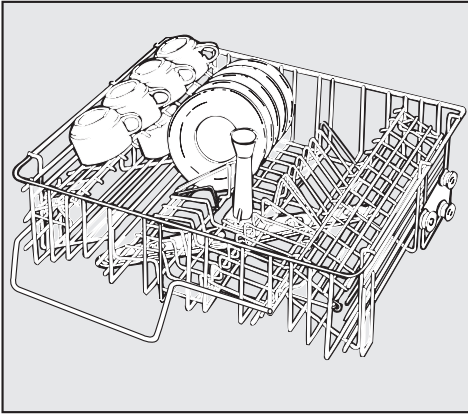

O 881 Top basket

for 20 cups, 24 saucers or 12 dessert plates.

Individual top and bottom baskets

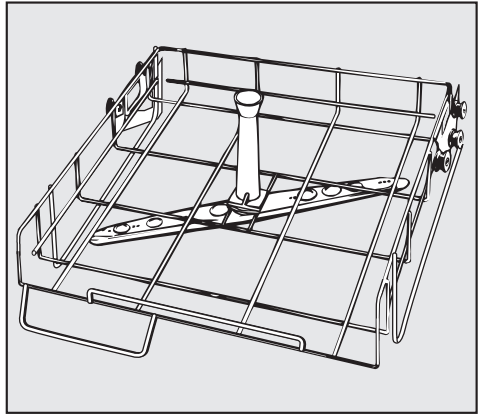

O 889 Top basket carrier

to take various inserts, e.g. containers for cutlery and glasses.

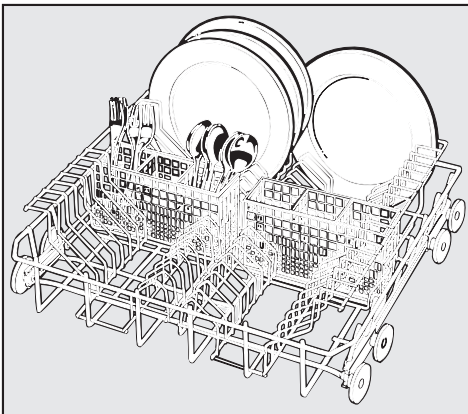

U 880 Bottom basket

with 2 x E 216 half inserts each for 15 plates Ø 240 mm and 2 x E 165 cutlery baskets for mixed cutlery.

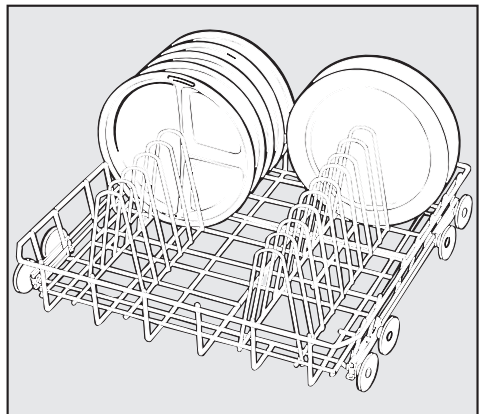

U 880 Bottom basket

with E 884 insert 1/1 for 20 large plates or 10 trays.

Loading the machine

Glass set GG/F-GL

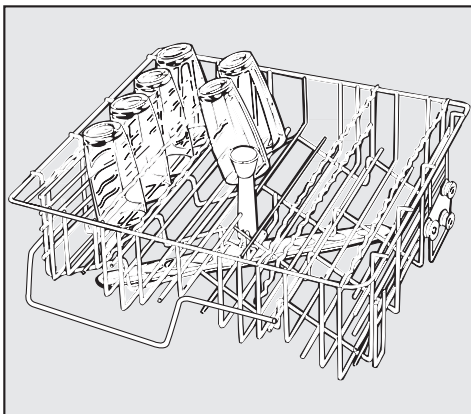

O 882 Top basket

for 27 glasses Ø 65 mm.

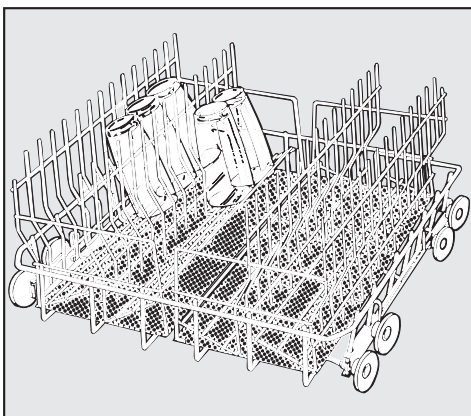

U 880 Bottom basket

with 2 x E 205 half inserts each for 14 glasses Ø 65 mm.

Adjusting the top basket

The top basket can be adjusted above and below the middle position by 2.5 cm. It is set in the middle position on delivery.

Depending on the position of the top basket, plates of the following diameter can be accommodated in the baskets:

Example: Top basket O 881

Top basket position	Top basket plate Ø in cm	Bottom basket plate Ø in cm
Top	max. 16.5	24 *)
Middle	max. 19	24 *)
Bottom	max. 21.5	24 *)

*) in insert E 216. For plates up to Ø 30 cm, use insert E 888.

To adjust the top basket:

- Pull out the top basket until a resistance is felt; lift from the runners and remove.
- Unscrew the knurled nuts (roller bearings) on both sides of the basket with a suitable spanner and reposition as required.

Items not suitable for dishwashers

- Cutlery with wooden or horn handles.
- Wooden or plastic cutting boards.
- Glued items, e.g. old knives with handles which have been glued on.
- Hand-made craft items.
- Copper or tin items.
- Plastic items which are not heat resistant.

Please note

- Silver and aluminium items can suffer some discolouration.
- Colours painted over a glaze may fade after a number of washes.
- Clouding may occur on glasses after frequent washing.

Our recommendations

- Wash delicate glassware by hand.
- When purchasing new glasses, dishes and cutlery make sure they are dishwasher safe.

Adding rinsing agent

Rinsing agent is necessary to ensure water does not cling and leave marks on items during the drying phase and to help items dry faster after they have been washed.

Rinsing agent is poured into the storage reservoir and the amount set is dispensed automatically in the final rinse.

The rinsing agent reservoir holds approx. 125 ml.

Except: Rinsing agent is not dispensed in the final rinse in the BEER GLASS programme. The final rinse in this programme is carried out with cold water only.

 Inadvertently filling the rinsing agent reservoir with powder or liquid cleaning agent will always cause serious damage to the reservoir. Make sure you use a rinsing agent which is suitable for use in this machine.

Adding rinsing agent

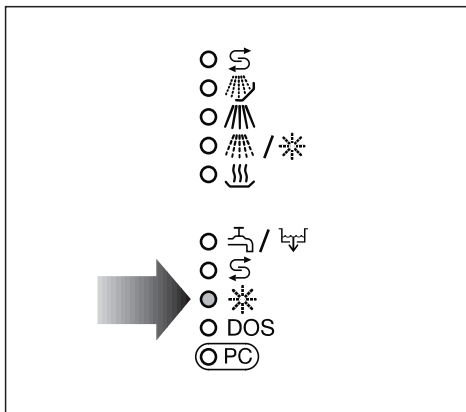

If the * Add rinsing agent indicator light on the control panel comes on, the rinsing agent reservoir must be refilled.

- Open the door fully.

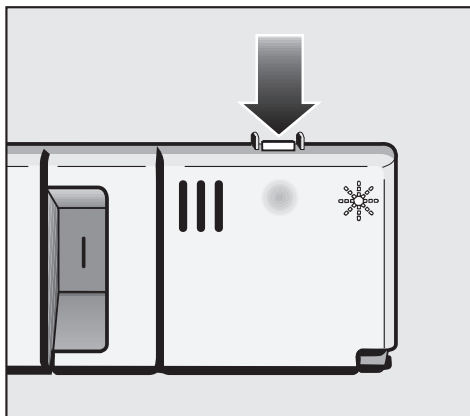

- Press the button in the direction of the arrow until the flap springs open.

Adding rinsing agent

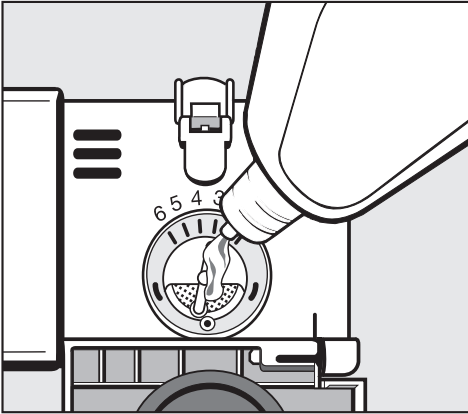

- Add rinsing agent only until it is visible on the surface of the filter in the opening.
- Close the flap firmly. The flap must audibly engage, otherwise water could get into the rinsing agent reservoir during the programme.
- Mop up any spilt rinsing agent. This prevents over-foaming occurring during the next programme.

The flap should always remain closed. Only open it to add more rinsing agent.

- Wait until the ✱ indicator light on the control panel lights up again before adding any more rinsing agent.

Adding rinsing agent

Setting the dosage

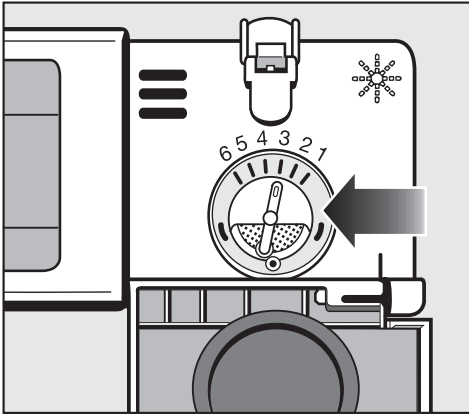

The dosage adjuster in the opening has settings from 1 to 6 (1-6 ml). It is set to 3 (3 ml) at the factory as the recommended dosage for **rinsing agent**.

- Use a higher setting if there are marks on the surface of utensils after drying.
- Use a lower setting if the surface becomes cloudy and smeary.

Adding cleaning agent

 Only use cleaning agents suitable for specialist machines. Do not use detergents formulated for domestic dishwashers.

Powder cleaning agent is dispensed via the dispenser for powder cleaning agents in the door or liquid cleaning agent via the DOS module (available as an optional extra - see "Note" on the next page).

If liquid cleaning agent is not being used, powder cleaning agent must be placed in the cleaning agent dispenser before every programme except with PRE-RINSE  (see notes on detergent dispensing in the programme chart).

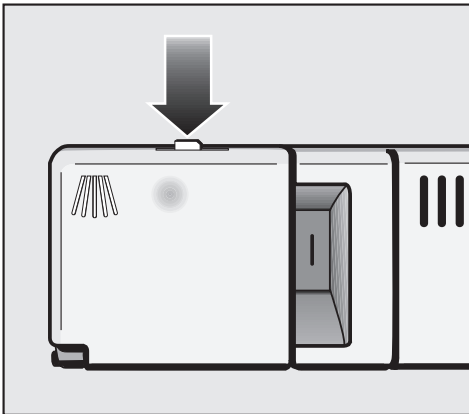

- Press the opening catch on the container forwards (see arrow). The flap will spring open. (The flap is always open at the end of a programme).

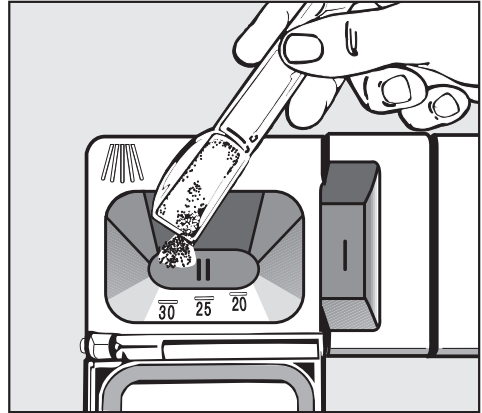

- Add powder cleaning agent to compartment II.

Dosage: Approx. 3 g/l, or 20 g per wash cycle.

Approx. 7 litres of water are used in the main wash.

Follow cleaning agent manufacturer's instructions if they differ.

- Close the dispenser lid.

Some types of soiling may require different combinations of cleaning agents and other additives. The Miele Professional Department will be pleased to advise you.

Adding cleaning agent

Note

As a chargeable optional extra, this machine can also be fitted with a DOS Module G 60 dispenser pump for liquid cleaning agent. This is connected externally.

See Programming special functions for venting the dispensing system and setting the dosage.

The optional DOS Module is supplied with its own installation and connection instructions.

Maintenance of the dispensing system

To ensure trouble-free operation, regular maintenance should be carried out at specified intervals by a Miele approved service technician.

Every two years

Replace the dispensing hoses in the DOS modules.









 Take great care when handling liquid agents and additives. These may contain irritant or corrosive ingredients.
Please follow the manufacturer's safety instructions.
Wear protective gloves and goggles.

Programme selection

Choose your programme according to the type of instruments or utensils being cleaned, and the degree of soiling.

The different programmes and their uses are described overleaf in the **Programme Chart**.

Programme chart

Programme	When to use	Powder cleaning agent (when not using liquid cleaning agent)
		Follow manufacturer's instructions
 PRE-RINSE	To rinse heavily soiled items, (e.g. for removing soiling or to prevent soiling drying on to dishes when a complete programme does not yet need to be run).	
 BEER GLASSES	Special programme for beer glasses. (Instead of being left to dry in the machine, beer glasses are taken out and dried by hand).	20 g in the powder dispenser
 GLASSWARE	Special programme for glasses.	20 g in the powder dispenser
 SHORT	Quick programme for lightly soiled crockery.	20 g in the powder dispenser
 UNIVERSAL	For normally soiled loads.	20 g in the powder dispenser
 UNIVERSAL PLUS	For normally soiled items with a higher wash temperature for removing foods rich in <u>starch</u>	20 g in the powder dispenser
 INTENSIVE	For heavily soiled crockery. Most of the soiling is removed in an intensive cold-water pre-rinse.	20 g in the powder dispenser
 DRAIN	For draining water out of the machine, e.g. when a programme has been interrupted. Turn the programme selector to the STOP position  first.	

Programme sequence

1. Economy pre-wash	2. Pre-wash	3. Main wash	4. Economy interim rinse	5. Interim rinse I	6. Interim rinse II ²⁾	7. Final rinse	8. Drying (Additional prog.)
				X			
		X 50°C/1' 1)		X	(X)	X —/1' 3)	(X)
		X 50°C/1' 1)		X	(X)	X 50°C/1' 1)	(X)
X		X 55°C/1' 1)			(X)	X 60°C/1' 1)	(X)
X		X 55°C/2' 1)		X	(X)	X 60°C/1' 1)	(X)
	X	X 60°C/3' 1)		X	(X)	X 60°C/1' 1)	(X)
X	X	X 65°C/3' 1)		X	(X)	X 60°C/1' 1)	(X)

X = Sections included in a programme (with temperature/temperature holding time)

¹⁾ To change a temperature or temperature holding time, see Programming special functions.



Important: We recommend programming a main wash temperature of 60°C for cleaning dirty crockery.

²⁾ To select a second interim rinse see Programming special functions.

³⁾ With cold water and without rinsing agent.



Changing a programme

Provided the START button has not yet been pressed, a wrongly selected programme may be changed as described below (if it has been pressed, see Cancelling a programme):

- Turn the programme selector to the required programme.
- Select additional function DRYING  again if required (see Selecting an additional function).
- Press the START button .







Selecting an additional function

The following additional function can be selected:

-  DRYING
Drying may be selected as an additional function as soon as the programme has been selected (except with PRE-RINSE  and DRAIN ). The drying phase operates with pulsed heating for ten minutes. The total running time of the programme lengthens accordingly.

Programme sequence indicators

The indicator light for the active programme stage lights up during the programme.

-  Reactivation
-  Pre-wash
-  Main wash
-  /  Interim rinse/Final rinse
-  Drying (additional function)

Programme end

The programme has ended when no more programme sequence indicator lights are lit up and the "Start" indicator light  has gone out. A 0 will appear in the middle of the display.

The buzzer will sound at the same time for a max. of 30 seconds (standard setting). The buzzer can be changed (see "Programming special functions").

Use the  button to see the total running time of a programme or the actual temperature.



Switching off

- Press and release the **I-0** button.

Operation

To cancel a programme

Once a programme is running it should only be cancelled in extreme cases, e.g. when articles in the machine rattle or jostle against each other and have to be rearranged.

- Turn the programme selector to the  position (the programme is cancelled after approx. 2 secs.).
- Open the door .

 Caution - Water and items in the machine may be hot. Danger of burning or scalding.

- Arrange the load securely. (Wear protective gloves where necessary, and observe appropriate health and safety regulations relating to infectious diseases).
- Replenish powder cleaning agent if necessary.
- Close the door.
- Select the DRAIN programme  (water in the machine is pumped away).
- Select the cleaning programme again and start it as previously described.

For future servicing work, please document any alterations to the standard factory settings.

Enter any alterations in the relevant Value set: _____ box.



1. Setting the cold water inlet from: Nominal water intake to Nominal water intake + 1 l.



The amount of water taken into the machine at each intake can be increased by 1 litre to a maximum of 9.5 litres.

To do this:

- Turn the programme selector to STOP .

- Switch the machine off.

- Press and hold  and  at the same time, and whilst doing so switch the machine on with the **I-0** button.

The current programme status “P...” appears in the display and the  /  indicator lights up.

- Press  once. E01 for programming level 1 will appear in the display.

- Turn the programme selector to the  position. A 10 or an 11 will appear in the display.

10 = Nominal water intake

11 = Nominal water intake + 1 l

- Press  to change from 10 to 11 or vice versa.

- Press . SP appears.

- Press  again. The change has been recorded.



Value set: _____



2. Selecting a second interim rinse

Interim Rinse II can be programmed in to improve interim rinsing in all programmes (except  PRE-RINSE).

- Turn the programme selector to STOP .

- Switch the machine off.

- Press and hold  and  at the same time, and whilst doing so switch the machine on with the **I-0** button.

The current programme status “P...” appears in the display and the  /  indicator lights up.

- Press  once. E01 for programming level 1 will appear in the display.

- Turn the programme selector to . A 30 or an 31 will appear in the display. 30 = without Interim rinse II. 31 = with Interim rinse II.

- Press  to change from 30 to 31 or vice versa.

- Press . SP appears.

- Press  again. The change has been recorded.

Value set: _____

Programming special functions











3. Delay start and setting the delay start time

The start of a wash programme can be delayed by up to 9 hours and 30 minutes in 30 minute stages.

Note:

Delay start should only be selected with the Universal and Intensive programmes. Because items in the machine stand for a longer period before being cleaned, residues can dry on if the start time is delayed. Shorter programmes may not be able to remove dried on soiling adequately.

a) To activate Delay Start

- Turn the programme selector to STOP .
- Switch the machine off.
- Press and hold  and  at the same time, and whilst doing so switch the machine on with the **I-O** button.
The current programme status “P...” appears in the display and the  /  indicator lights up.
- Press  once. E01 for programming level 1 will appear in the display.
- Turn the programme selector to .
80 or 81 will appear in the display.
80 = No delay start
81 = Delay start active.
- Press  to change from 80 to 81 or vice versa.
- Press . SP appears.
- Press  again. The change has been recorded.

Value set:

b) Setting the delay start period







The delay start period (from 30 minutes to 9 hours and 30 minutes) has to be set before a programme is started.

- After selecting a programme (see “Switching on”) Press the  button or hold it in until the required value is displayed. The “Delay Start” indicator light comes on.



After the START button  has been pressed the delay start period will count down in the display until the programme automatically starts.

Programming special functions

4. Venting and setting the dosage on DOS modules G 60 and C 60 (optional extra)

- Set the dosage selector on the DOS module to position 10 (applies to DOS Module C 60 only).
- Turn the programme selector to STOP .
- Switch the machine off.
- Press and hold  and  at the same time, and whilst doing so switch the machine on with the **I-0** button.
The current programme status "P..." appears in the display and the  /  indicator lights up.
- Press  twice, E02 for programming level 2 will appear in the display.

Venting the dispensing system:

- Turn the programme selector to the  position. do1 appears in the display.
- Press  for 90 seconds.
The dispensing system will be vented automatically.

If only venting is required:

- Switch the machine off with the **I-0** button.

Immediately after this: start the PRE-RINSE  programme, so that after venting any agents in the wash cabinet are diluted before being drained away.



Setting the dosage:

Set the dosage according to the manufacturer's recommendations.



The machine needs 7 litres of water in the main wash stage of the programme.

Example:

A manufacturer recommends 4 ml cleaning agent per litre of water:
 $7 \text{ l} \times 4 \text{ ml/l} = 28 \text{ ml}$.
2 ml  1 second dispensing time; i.e. programming to 14 seconds.

- Turn the programme selector to , the dispensing time in seconds appears in the display, e.g. 10.
- Press  repeatedly or hold it in, until the number 14 appears in the display (dispensing time 14 seconds  28 ml - see example -).
The dispensing time/amount is set.

■ Having changed a value or all values:

- Press . SP appears.
- Press  again. The change has been recorded.

Value set: _____

If the dispensing system also needs to be vented:

- Start the PRE-RINSE programme , so that after venting any agents in the wash cabinet are diluted before being drained away.

Programming special functions





5. Altering the temperature and/or the temperature holding time in the "Main wash" and "Final rinse" programme stages







Please make a note of any changes to the temperature and / or the temperature holding time in the appropriate section of the [programme chart](#).

The programme chart shows the factory settings for the [Main wash temperature](#) together with temperature holding time and the [Final rinse temperature](#) with its temperature holding time.







The special functions can be used to alter the temperatures of the main wash and of the final rinse from 30 °C -70 °C and the temperature holding time from 1-10 minutes.

Important: We recommend programming a main wash temperature of 60°C for cleaning dirty crockery. The final rinse temperature cannot be programmed or altered in the  BEER GLASSES programme.

- Turn the programme selector to the STOP position  (the programming level is displayed only in this switch position).
- Switch the machine off.
- Press and hold  and  at the same time, and whilst doing so switch the machine on with the **I-O** button.
The current programme status "P..." appears in the display and the  /  indicator lights up.

- **"Main wash" temperature:**
Press  three times, E03 for programming level 3 will appear in the display.
- Turn the programme selector to the programme which needs to be changed. The actual value appears in the display after **°C**.
- Press  or hold it in, until the required value appears in the display.
- **"Main wash" temperature holding time:**
Turn the programme selector to the STOP position  (the programming level is only displayed in this switch position).
- Press  again, E04 for programming level 4 will appear in the display. Then:
- Turn the programme selector back to the programme which needs to be changed. The actual value appears in the display after **min**.
- Press  until the required value appears in the display.
- **"Final rinse temperature:**
Turn the programme selector to the STOP position  (the programming level is only displayed in this switch position).
- Press  again, E05 for programming level 5 will appear in the display. Then:









Programming special functions

- Turn the programme selector back to the programme which needs to be changed. The actual value appears in the display after **°C**.
- Press  or hold it in, until the required value appears in the display.
- **Final rinse temperature holding time:**
Turn the programme selector to the STOP position 
(the programming level is only displayed in this switch position).
- Press  again, E06 for programming level 6 will appear in the display. Then:
- Turn the programme selector back to the programme which needs to be changed. The actual value appears in the display after **min**.
- Press  until the required value appears in the display.
- **Having changed a value or all values:**
- Press . SP appears.
- Press  again. The change has been recorded.

Programming special functions

6. Audible tone (Buzzer)

This special function allows you to programme a buzzer (lasting up to a maximum of 30 seconds) for the following functions:

- Programme end = Constant buzzer
- Fault warning = Buzzer at one second intervals
- Turn the programme selector to STOP .
- Switch the machine off.
- Press and hold  and  at the same time, and whilst doing so switch the machine on with the **I-0** button.
The current programme status “P...” appears in the display and the  /  indicator lights up.
- Press  once. E01 for programming level 1 will appear in the display.
- Turn the programme selector nine switch positions clockwise (9 o'clock position).
A number from 90 to 93 will appear in the display.
90 = buzzer switched off.
91 = buzzer at end of programme (standard setting)
92 = fault indication
93 = buzzer for all functions (at end of programme and for faults).
- Press  until the required function is displayed.
- Press . SP appears.

- Press  again. The change has been recorded.



Value set: _____

Note:

The buzzer can be switched off early by

- turning the programme selector to the STOP position ,
- interrupting the power supply (e.g. by opening and closing the door).

7. Re-setting all parameter changes back to the factory settings.

- Turn the programme selector to STOP
⏏.
- Switch the machine off.
- Press and hold **min °C** and ⏏ at the same time, and whilst doing so switch the machine on with the **I-0** button.
The current programme status “P...” appears in the display and the  /  indicator lights up.
- Press **+W** seven times, E07 for programming level 7 will appear in the display.
- Turn the programme selector to any switch position (except STOP).
00 or PP will appear in the display.
00 = factory setting
(Electronics have not been re-programmed).
PP = Electronics have been re-programmed.
- If PP is displayed press **min °C** to change from PP to 00.
- Press ⏏. SP appears.
- Press ⏏ again. All values which had been changed have now been reset to the factory settings.

If the hardness level setting in the water softener had been changed this will reset to the factory setting of 19 °d (3.4 mmol/l). This will need to be reset to suit the hardness level in your area.

Cleaning and care

Cleaning the filters in the wash cabinet

 The machine must not be used without all the filters in place.

The filter combination in the base of the wash cabinet should be inspected regularly and cleaned if necessary.

 **Caution:**
Watch out for glass splinters which could cause injury.

Cleaning the coarse filter

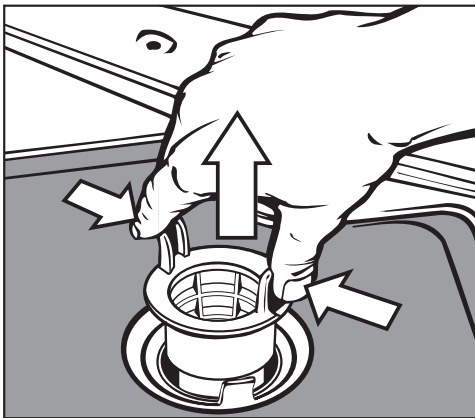

- Press the two lugs together, remove and clean the filter.
- Put the clean filter back in position and press it until it clicks into place.

Cleaning the flat and the micro-fine filters

- Remove the coarse filter.

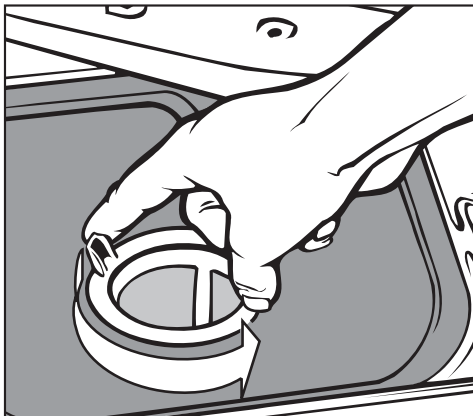

- To unscrew the micro-fine filter, take hold of the two lugs and turn twice in an anti-clockwise direction,

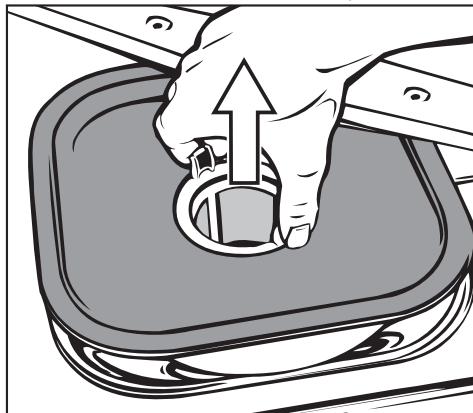

- and remove, together with the flat filter.
- Clean the filters.
- The filter combination is then replaced in the reverse order in which it was removed.

Cleaning the spray arms

Waste particles can lodge in the spray arm jets.

The spray arms should be inspected and cleaned regularly (approx. every 6 months).

- Use a sharp pointed object to push particles into the spray arm jets and rinse well under running water.

Remove the spray arms as follows:

- Unscrew the **upper** spray arm.
- Remove the **middle** spray arm (on the top basket) by unscrewing the toothed wheel mechanism.

Important:

The toothed wheel mechanism has a left hand thread, and to unscrew it, it must be turned to the right with the spray arm.

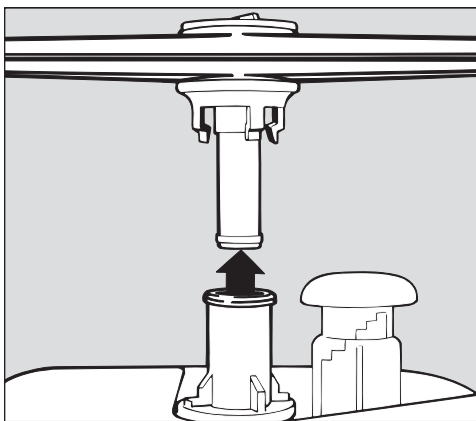

- First remove the bottom basket and then pull the **lower** spray arm off.

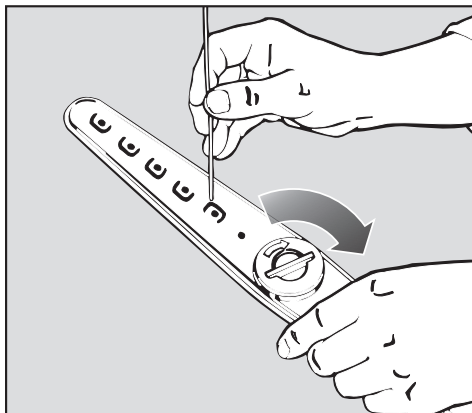

Particles in the lower spray arm are easier to rinse out if the cap is first opened.

- Open the cap in the direction of the arrow. After cleaning close up the cap again.

Important:

After replacing the spray arms check that they move freely.

Cleaning and care

Cleaning the drain pump and non-return valve

If water has not been pumped away at the end of a programme the drain pump or the non-return valve might be blocked. They are however, easy to clean.

- Take the filter combination out of the wash cabinet.

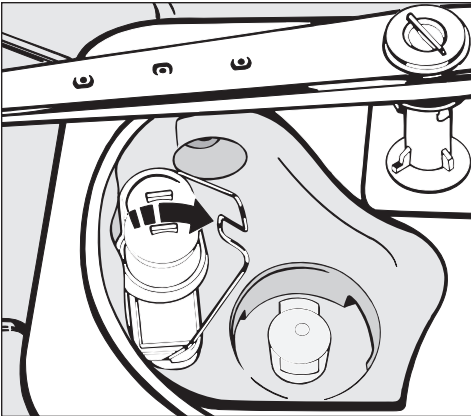

- Release the locking clamp.
- Lift up the non-return valve and rinse under running water.

The drain pump is situated under the non-return valve (see arrow).

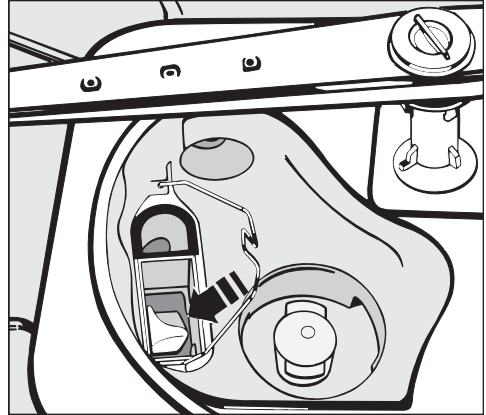

- Before replacing the non-return valve check that the drain pump is free of obstructions.
- Carefully replace the non-return valve and secure with the locking clamp.

Cleaning the filters in the water inlet

Filters are incorporated in the screw connection of the water inlet hose to protect the water inlet valve. If these filters get dirty they need to be cleaned, otherwise insufficient water flows into the wash cabinet.

 The plastic housing of the water connection contains an electrical component. It must not be dipped in water.

To clean the filters

- Disconnect the machine from the mains supply (switch off at the mains and pull out the plug, switch off the appropriate circuit in the fuse box or withdraw the mains fuse).
- Turn off the stopcock and unscrew the water inlet hose.

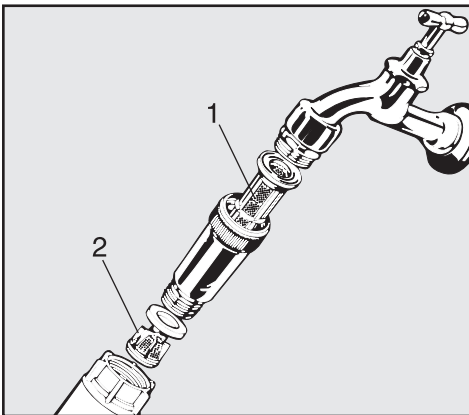

- Clean the large area filter (1) and fine filter (2), and replace with new filters if necessary.

- Replace filters and the seal. Make sure they are sitting correctly.
- Reconnect the hose to the water inlet, making sure that it goes back on straight.
- Open the stopcock carefully. If there is a leak, screw the connections on more tightly.

Cleaning the control panel

- This should only be cleaned with a damp cloth or a suitable cleaner for use on plastic materials, or with a disinfectant tested and recognised as suitable for this use.

 Do not use abrasive cleaners, glass cleaners or all-purpose cleaners. Because of their chemical composition they could cause serious damage to plastic components.

Cleaning the front of the machine

- Clean using a proprietary cleaning agent designed for the type of front the machine is fitted with.

 Do not use cleaning agents containing ammonia or thinners.

Correcting minor faults

With the aid of the following explanatory notes, minor faults can be corrected without contacting the Miele Service Dept.

Any work on the electrical components of the machine should only be carried out by a suitably qualified and competent person in accordance with local and national safety regulations. Unauthorised repairs could be dangerous.

Faults / possible causes

The machine does not start

- The door is not properly closed.
- The machine is not switched on at the mains.
- The fuse is defective / has blown.

A few minutes after switching on, the / indicator light flashes (fault code F..E appears in the display)

- The stopcocks are closed.
- The filters in the water inlet hose are dirty.
- The water pressure is too low.
- Turn the programme selector to the STOP position  (the fault code goes out).
- Press **I-O** to switch the machine off.
- Open the stopcocks or clean the filters (see "Cleaning and Care").
- Switch the machine on again and reselect the programme.

The wash cycle finishes too early and the / indicator light flashes (fault code F A appears in the display)

- The drain hose is kinked.
- The drain pump is blocked
- Turn the programme selector to the STOP position  (the fault code goes out).
- Straighten the hose and check/clean the drain pump.
- Pump away the water and start the programme again (see additional programme "DRAIN" and "Switching on").

Water in the wash cabinet is not heated; the programme sequence lasts too long

This machine has a resettable heater limiter which will switch off the heaters if they over-heat. This could be caused for example, by large articles covering the heating elements or if the filters in the wash cabinet are blocked.

- Remove the cause of the fault.
- Take off the service panel (see "Electrical connection").

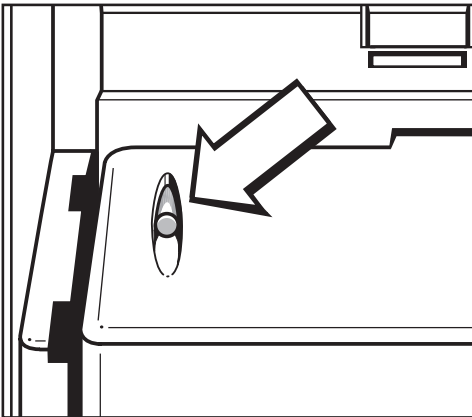

- Press the reset button on the heater limiter (yellow) located on the left-hand side of the plastic cover.

If this switch trips again contact the Miele Service Department.

Customer service

Should you still have any difficulties or if a fault code "F..." appears in the display again, please contact your authorised Service Dealer or the Miele Service Department. See back cover for addresses. Please quote the fault code as well as the model type and number of your machine.

Installation

Please refer to the installation diagram supplied with the machine.

 Furniture and fittings installed near the machine must be of a commercial standard able to withstand the effects of steam and condensation.

The machine must be installed correctly and levelled.

Any unevenness in the floor level can be compensated for and the height of the machine raised or lowered by adjusting the four screw feet.

The machine can be installed in the following ways:

■ Free-standing.

■ Slot-in or at the end of a row:

The machine can be installed next to other machines or furniture or in a suitable niche. The niche must be at least 60 cm wide and 60 cm deep.

■ Built-under:

The machine can be installed under a continuous worktop or sink drainer. The recess must be at least 60 cm wide, 60 cm deep and 82 cm high.

If necessary, the machine lid can be removed as follows:

■ Open the door.

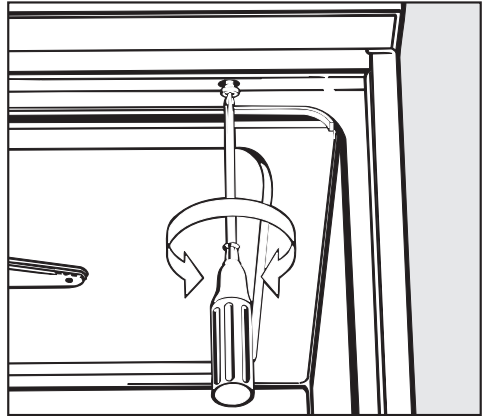

■ Remove the fixing screws on the left and right hand sides using a cross slotted screwdriver.

■ Pull the machine lid approx. 5 mm forwards, lift it upwards and remove it.

Position and secure the machine

To ensure stability the machine must first be aligned and then screwed to the worktop.

- Open the door. Secure the machine to the front edge of the worktop using screws through the holes on the left and right hand sides of the front trim.
- Do not use silicone sealant to seal the gaps between the machine and any neighbouring units as this would hinder ventilation to the circulation pump.

Depending on the requirements for building under, the following kits can be ordered from the Miele Spares Dept.:

Cover plate (protects the worktop)

The underside of the worktop is protected against water damage by a stainless steel plate.

Decor frame fitting kit

The machine front can be fitted with a decor panel to match kitchen units. The decor frame is supplied with fitting instructions.

Electrical connection

 All electrical work must be carried out by a suitably qualified and competent person in accordance with local and national safety regulations.

- Connection should be made via a suitable isolator, with an on-off switch which should be easily accessible for servicing work.

WARNING THIS APPLIANCE MUST BE EARTHED

- For extra safety it is advisable to install a residual current device with a trip current of 30 mA (in accordance with DIN VDE 0664).
- The mains connection cable may only be replaced by an original Miele spare part or an appropriate cable with wire end ferrule.
- For technical data see data plate or wiring diagram supplied.

The machine must only be operated with the voltage, frequency and fusing shown on the data plate.

This machine **can be converted** in accordance with the conversion diagram and wiring diagram supplied.

The data plate (with test certification VDE, DVGW etc.) and conversion key are located on the rear of the machine and also behind the plinth panel below the protective plastic cover.

The wiring diagram is secured to the inner side of the protective plastic cover.

Removing the plinth panel and the protective plastic cover:

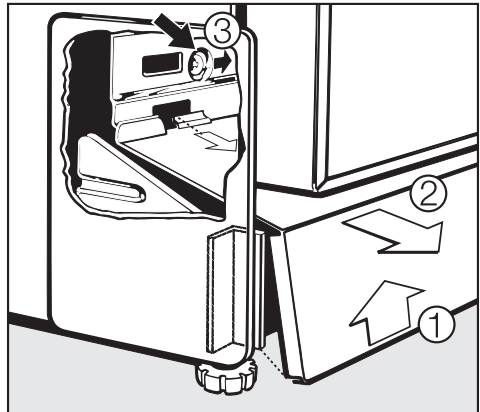

 Disconnect the machine from the mains electricity supply.

- Holding the plinth panel at both sides, pull gently outwards from beneath ① and pull it off ②.
- To remove the protective plastic cover loosen the 2 screws (left and right) ③.

To re-assemble:

- Refit the protective plastic cover and the plinth panel in the reverse order to which they were removed.



See also the installation diagram supplied.

Bonding connection

There is a screw connection point marked with the earth symbol () at the back of the machine, to which the earth lead must be connected.

Connection to the water inlet

 Water in the machine must not be used as drinking water.

- The machine must be connected to the water supply in accordance with local and national water authority regulations.
- This machine is constructed to comply with German water regulations (DVGW), and may be connected to a suitable supply without an extra non-return valve if national regulations permit. In the UK this machine is listed as a WRAS approved product in the Water Fittings and Materials Directory of products which comply with the Water Fittings Regulations. It is approved for mains water connection in fluid categories 4 and 5, when installed using the double check valves supplied.
- The water pressure (flow rate) must be a minimum of 0.5 bar (50 kPa). If the water pressure (flow rate) is below 2 bar (200 kPa) the fill time is automatically extended. The max. permitted static pressure is 10 bar (1000 kPa). If the water pressure is not in the range of 0.5 to 10 bar (50-1000 kPa) the  /  indicator light may come on and the fault code "F2E" show in the display. Please contact the Miele Service Department.
- The machine is supplied as standard for connection to a cold or a hot water supply up to a max. temperature of 70 °C.

- A stopcock with 3/4 inch male thread must be provided on site. It should be easily accessible so that the water supply can be turned off when the machine is not in use.
- The DN 10 inlet hose is approx. 1.7 m long terminating in a 3/4 inch female thread. A 1.5 metre long flexible metal extension hose, pressure tested to 140 bar, is available as an optional accessory if required. On no account may the inlet filter be removed.
- A large surface area filter is enclosed in the kit supplied with the machine for installing between the stopcock and the inlet hose (see illustration in "Cleaning and Care - Water inlet").

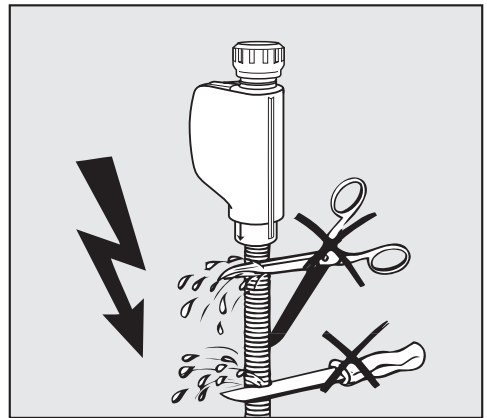

 The inlet hose must not be shortened or damaged in any way (see illustration).

See also the installation diagram supplied.

Plumbing

Drainage

- The drainage system is fitted with a non-return valve which prevents dirty water from flowing back into the machine via the drain hose.

- The machine should preferably be connected to a separate drainage system on-site.

If separate drainage is not available contact your Miele application specialist for professional advice.

The on-site drain connection point should be sited between 0.3 m and 1 m above the lower edge of the machine.

If it is lower than 0.3 m lay the hose in a curve at a height of at least 0.3 m.

The drainage system must be able to take a minimum drainage flow of 16 l/min.

- The inlet hose is approx. 1.4 m long, is flexible and has an internal diameter of 22 mm. It must not be shortened.

Hose clips are supplied for securing it in position.

- A longer drain hose (up to 4 m long) is available to order from the Miele Spare Parts Dept.

- The drainage system must not exceed 4 metres.

See also the installation diagram supplied.

Technical data

Height:	85 (82) cm
Width:	60 cm
Depth:	60 cm
Voltage:	see data plate
Rated load:	see data plate
Fuse rating:	see data plate
Mains connection cable:	approx. 1.8 m
Water pressure (flow rate):	0.5 - 10 bar (50 -1000 kPa)
Cold or hot water connection:	up to max. 70 °C
Delivery head:	min. 0.3 m, max. 1 m
Drainage length:	max. 4 m
Inlet hose	approx. 1.7 m
Drain hose:	approx. 1.4 m
Noise level in dB (A):	
Sound level LpA	Free standing: <70 Built under: <70
Test marks:	VDE, interference suppression, DVGW, CE

**United Kingdom:**

Miele Co. Ltd.
Fairacres, Marcham Road
Abingdon, Oxon, OX14 1TW
tel. Abingdon (01235) 554455
Service Office: (01235) 554466
fax (01235) 554477
Internet: www.miele.co.uk

Ireland:

Miele Ireland Ltd.
Broomhill Road, Tallaght, Dublin 24
Tel: (01) 46 10 710, Fax: (01) 46 10 797
Email: info@miele.ie
Internet: <http://www.miele.ie>

Australia:

Miele Australia Pty. Ltd.
A.C.N. 005635398
1 Gilbert Park Drive
Knoxfield, VIC 3180
Telephone: (03) 9764 7100
Fax: (03) 9764 7129
Internet: www.miele.com.au

Distributor New Zealand:

Steelfort Engineering Company. Ltd.
500 Rangitikei Street
Palmerston North, Priv. Bag 11045, NZ
Telephone: (06) 350 1350
Fax: (06) 356 1507

South Africa:

Miele (Pty) Ltd
63 Peter Place
Bryanston 2194
P.O. Box 69434
Bryanston 2021
Tel.: (011) 548 1900
Telefax (011) 548 1935
Internet: www.miele.co.za
E-mail: info@miele.co.za

Singapore:

Miele Southeast Asia
Miele Pte. Ltd.
163 Penang Road
04 - 02/03 Winsland House II
Singapore 238463
Tel : +65-67351191
Fax: +65-67351161
Email: infosea@miele.com.sg
Internet: www.miele.sg

Hong Kong:

Miele (Hong Kong) Limited
AIA Plaza, 24th Floor
18 Hysan Avenue
Causeway Bay
Hong Kong
Tel.: (852) 2610 1331
Fax: (852) 2610 1013
E-mail: mielehk@miele.com.hk

Free Manuals Download Website

<http://myh66.com>

<http://usermanuals.us>

<http://www.somanuals.com>

<http://www.4manuals.cc>

<http://www.manual-lib.com>

<http://www.404manual.com>

<http://www.luxmanual.com>

<http://aubethermostatmanual.com>

Golf course search by state

<http://golfingnear.com>

Email search by domain

<http://emailbydomain.com>

Auto manuals search

<http://auto.somanuals.com>

TV manuals search

<http://tv.somanuals.com>