

Operating instructions

Commercial dishwasher G 7860

To avoid the risk of accidents or damage to the machine it is **essential** to read these operating instructions before it is installed, commissioned or used for the first time.



M.-Nr. 06 134 790

Contents

Description of the machine	3
Guide to the machine	4
Warning and Safety instructions	6
Caring for the environment	10
Before using for the first time	11
Opening and closing the door	12
Water softener	14
Setting the water softener	16
Filling the salt reservoir	17
Salt indicator	18
Adding rinsing agent	19
Setting the dosage	20
Adding cleaning agent	21
Loading the machine	23
Loading the machine	23
Adjusting the top basket	25
Items not suitable for dishwashers	25
Selecting a programme	26
Programme chart	28
Operation	30
Switching on	30
Starting a programme	30
Changing a programme	31
Selecting an additional function	31
Programme sequence display	31
Switching off	31
To cancel a programme	32
Programming special functions	33
Cleaning and care	39
Correcting minor faults	43
After sales service	44
Installation	45
Electrical connection	47
Plumbing	49
Technical data	51

Description of the machine

This Miele machine is a professional washer disinfectant with a freshwater system, very short batch times and high cleaning performance.

This machine is equipped with a water softener (WE), a steam condenser (DHK) and an electro-thermal door lock (ET) as standard.

This equipment may only be installed in mobile installations such as ships, oil rigs etc. if a risk assessment of the installation has been carried out by a suitably qualified engineer.

Guide to the machine

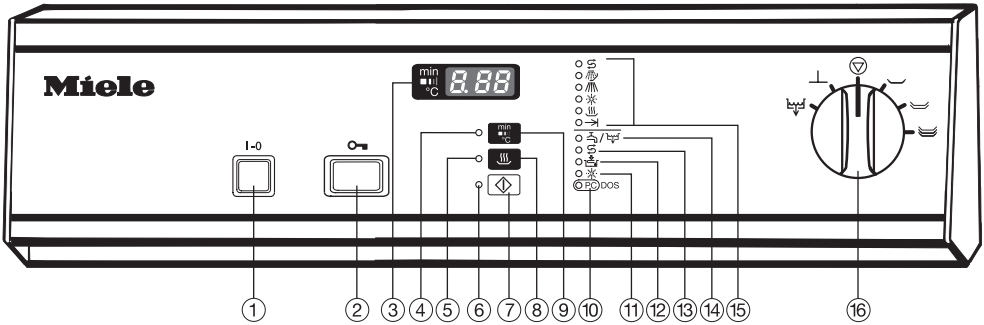

- ① On/Off button (1-0)
 - ② Door release
 - ③ Display
 - ④ Delay start indicator light
 - ⑤ Drying indicator light
 - ⑥ Programme start indicator light
 - ⑦ Start button
 - ⑧ Drying button
 - ⑨ Button to toggle between the actual temperature, elapsed time and active washing block displays
 - ⑩ Add liquid cleaning agent indicator light *
 - ⑪ Optical interface for service technician
 - ⑪ Add rinsing agent indicator light
 - ⑫ Add neutralising agent indicator light (not used on this machine)
 - ⑬ Add salt indicator light
 - ⑭ Water inlet / Drain indicator light
 - ⑮ Programme sequence indicators
 - ⑯ Programme selector
- * only applies to machine fitted with optional external DOS Module

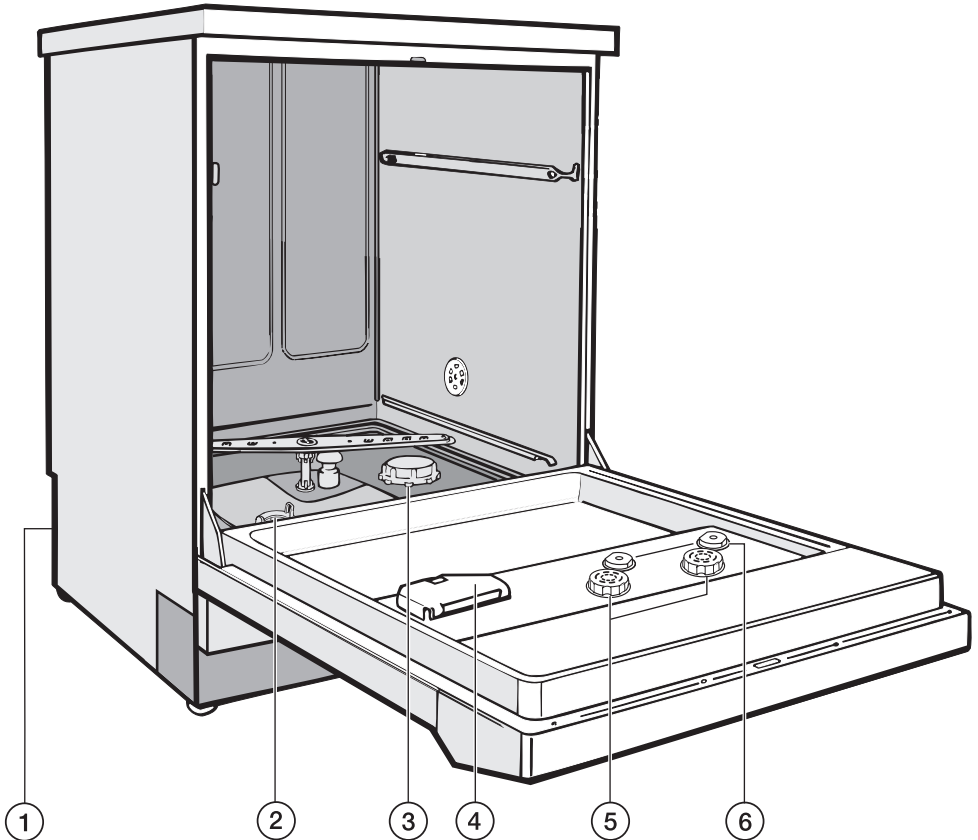

① Connections for optional DOS module dispenser pump for liquid cleaning agent - at the back of the machine -

② Filter combination

③ Salt reservoir (for the water softener)

④ Dispenser for powder cleaning agent

⑤ Dual rinsing agent reservoir (with dosage selector)

⑥ Level indicators

Warning and Safety instructions

This machine complies with all relevant local and national safety requirements. Incorrect use can lead to personal injury and damage to property.

Read the operating instructions carefully before starting to use this machine. This way you will avoid the risk of accidents and damage to the machine.

Keep these instructions in a safe place for reference, and pass them on to any future user.

Correct use

■ This machine is designed for commercial use only, as described in these Operating Instructions. Alterations to the machine, or using it for purposes other than those for which it was designed, are unauthorised and could cause harm. The manufacturer cannot be held liable for damage caused by improper or incorrect use of the machine.

■ This equipment may only be installed in mobile installations such as ships, oil rigs etc. if a risk assessment of the installation has been carried out by a suitably qualified engineer.

Please pay attention to the following notes to avoid injury and damage.

■ This machine should be commissioned and then maintained by a Miele authorised and trained service technician or other suitably qualified and competent approved person. Repairs and other work by unqualified persons could be dangerous.

■ Do not install the machine in an area where there is any danger of explosion or of freezing conditions.

■ The electrical safety of this machine can only be guaranteed if connected to a correctly installed earthing system on site. It is imperative that this basic safety requirement is tested regularly and, where there is any doubt, the electrical wiring system on site should be inspected by a qualified electrician.

The manufacturer cannot be held liable for damage or injury caused by the lack of or inadequacy of an effective earthing system (e.g. electric shock).

■ A damaged machine is dangerous. Switch off at the mains immediately and call the Miele Service Department or an authorised and trained Miele Service Dealer or other suitably qualified and competent approved person.

Warning and Safety instructions

■ Personnel operating the machine should be trained regularly.

Untrained personnel should not be allowed access to the machine or its controls.

■ This machine is not a toy! Do not allow children to play in or around it, or to operate it. There is a danger they could injure themselves, or get into the machine and lock themselves in.

■ Take great care when handling liquid agents and additives. These may contain irritant or corrosive ingredients. Do not use organic solvents as these could cause an explosion.

Follow all relevant safety procedures carefully. Wear protective gloves and goggles. With all chemical agents, the manufacturer's safety conditions must be observed.

■ Avoid inhalation of powder cleaners. They can cause burning in the mouth and throat if swallowed, and can inhibit breathing.

■ The water in the machine must not be used as drinking water.

■ Do not sit or lean on an open door. The machine could tip up and be damaged, or cause an injury.

■ Be careful when sorting items with sharp pointed ends and positioning them in the machine that you do not hurt yourself or create a danger for others. Sharp knives etc. should be placed in the baskets with the pointed end facing downwards.

■ When using this machine in the higher temperature ranges be

especially careful not to scald or burn yourself when opening the door. Baskets and inserts must be allowed to cool down before they are unloaded. Any water remaining in containers could still be very hot. Empty them into the wash cabinet before taking them out.

■ Do not touch the heating elements if you open the door during or directly after the end of a programme: you could burn yourself. They remain hot for some time after the end of the programme.

■ Never clean the machine or near vicinity with a water hose or a high pressure hose.

■ Before any maintenance or repair work is carried out, the machine must be disconnected from the mains supply by switching off at the mains isolator or withdrawing the mains fuse.

The following points should be observed to assist in maintaining quality standards, to protect users, and to avoid damage to the machine and items being cleaned.

■ Only use Miele approved cleaning agents in this machine. Use of unsuitable cleaning agents could adversely affect the components of the machine as well as items being cleaned.

■ Foam can have an adverse effect on the cleaning process. Only use low-foaming cleaning agents which have been approved by Miele. Some types of soiling can also cause foaming to occur.

Warning and Safety instructions

Where a chemical additive is recommended on technical application grounds (e.g. a cleaning agent), this does not imply that the manufacturer of the machine accepts liability for the effect of the chemical on the items being cleaned.

Please be aware that changes in formulation, storage conditions etc. which may not be publicised by the chemical manufacturer, can have a negative effect on the cleaning result.

When using cleaning agents and special application products, it is essential that the manufacturer's instructions are followed. Only use such products for the purpose and in the situation specified to avoid such dangers as chemical reactions and material damage.

The machine is designed for operation with water and additive cleaning agents only. Organic solvents must not be used in this machine, as there is the danger under certain circumstances of fire or explosion. (Although this is not the case with all organic solvents, other problems could arise with their use, for example damage to rubber and synthetic materials).

In critical applications where very stringent requirements have to be met, it is strongly recommended that all the relevant factors for the process, such as cleaning agents, water quality etc., are discussed with the Miele Application Technology specialists.

If cleaning and rinsing results are subject to particularly stringent requirements (e.g. chemical analysis, specialised industrial processes etc.), a regular quality control test must be carried out by the user to ensure that required standards of cleanliness are being achieved.

The special inserts should only be used for their specific application.

Empty any containers or utensils before arranging them in the machine.

Do not allow any remains of acids or solvents, and in particular hydrochloric acid or chloride solutions, to get into the wash cabinet. Similarly avoid any materials with a corrosive effect.

The presence of solvents exceeding trace levels should not be present in soiling (especially those in hazard class A1).

To avoid any corrosion damage, ensure that solutions or steam containing hydrochloric acid do not come into contact with the steel outer casing of the machine.

Please follow the advice on installation in these instructions and the separate Installation Instructions.

Using accessories

■ Only use genuine Miele accessories with this machine. Consult Miele on the type and application of such equipment.

Disposal of your old machine

■ Before disposing of your old machine first make it unusable. Disconnect from the mains, cut off the cable near the machine and any plug from the cable.

For environmental and safety reasons ensure the machine is completely drained of any residual water and cleaning agent. (Observe safety regulations and wear safety goggles and gloves).

Make the door lock inoperative, so that children cannot accidentally shut themselves in. Then make appropriate arrangements for the safe disposal of the machine.

The manufacturer cannot be held liable for damage caused by non-compliance with these Warning and Safety instructions.

Caring for the environment

Disposal of the packing material

The transport and protective packing has been selected from materials which are environmentally friendly for disposal and can normally be recycled.

Ensure that any plastic wrappings, bags etc. are disposed of safely and kept out of the reach of babies and young children. Danger of suffocation!

Rather than just throwing these materials away, please ensure that they are recycled.

Disposal of your old machine

Old machines contain materials which can be reclaimed or recycled. Please contact your dealer, your waste collection centre or scrap merchant about potential recycling schemes.

Ensure that the machine presents no danger to children while being stored for disposal.

See the appropriate section in the Warning and Safety instructions.

Before using for the first time

Before using for the first time please pay special attention to the following points.

Detailed information on these points can be found in the relevant sections of these Operating Instructions.

Set the water softener unit

The water softener unit must be set for the water hardness level in your area.

The salt reservoir also has to be filled, first with water and then with reactivation salt.

 Filling the salt reservoir with cleaning agent by mistake will cause serious damage to the water softener. Please check every time before refilling that the package contains reactivation salt.

Add rinsing agent

 Inadvertently filling the reservoir for rinsing agent with cleaning agent (including liquid cleaning agents and washing up liquid) will cause serious damage to the reservoir.

Only use designated cleaning agents for special applications.

Do not use cleaning agents formulated for use in domestic dishwashers.

Load the machine carefully

Arrange the load so that water will come into contact with all surfaces. Concealed surfaces will not be cleaned.

The spray arms must not be blocked by any items.

Add cleaning agent

Follow the cleaning agent manufacturer's recommendations on dosage.

The amount required will depend on the type of cleaning agent and the programme chosen.

Make sure you read the notes on dosing given in the programme chart.

Cleaning results may vary from brand to brand. If you are not satisfied with the results from one brand, try another quality brand before contacting Miele for advice.

The filter combination at the base of the wash cabinet and the spray arms must be kept clean.

Regular checking and cleaning is essential.

Opening and closing the door

Electro-thermal door lock

The machine is equipped with an electro-thermal door lock.

The door can only be opened when:

- the electricity supply to the machine is switched on and;
- the On/Off button **I-O** is pressed in.



To open the door

- Press the door button in as far as it will go, and at the same time, grip the handle and open the door.

 Do not touch the heating elements if you open the door during or directly after the end of a programme, you could burn yourself. The elements remain hot for some time after the end of the programme.

To close the door

- Lift the door upwards and push until it clicks shut. Do not press the release catch whilst shutting the door!

After the first intake of water, it is no longer possible to open the door, except in the  (PRE-RINSE) and  (DRAIN) programmes. The machine can be opened during drying if this option has been selected.

The door remains locked until the end of the programme. It can then be opened.

To cancel a programme

If a programme has to be cancelled in an emergency, e.g. when articles in the machine jostle against each other or the programme has been interrupted because of a fault, the door will have to be opened manually:

- Turn the programme selector to the  position (the programme is cancelled after approx. 2 secs.).

Important!

See "To cancel a programme" in the "Operation" section of this booklet for details of how to continue from here.

To open the door with the emergency release

The emergency release should only be used when the door cannot be opened normally, e.g. in the event of a power failure.

- Turn the programme selector to .
- Press the On/Off button **I-O** to switch the machine off.

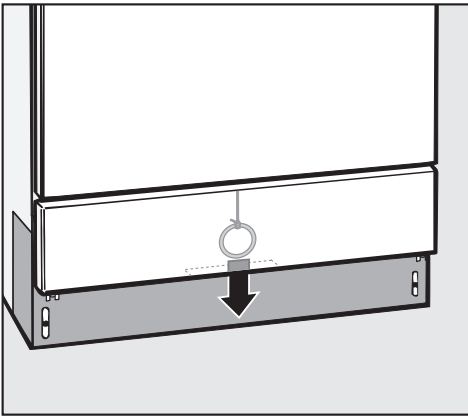

- The emergency release cable is located at the bottom of the machine behind the service panel. Pull it downwards to open the door.

Water softener

The water needs to be softened to avoid calcium deposits building up on instruments and utensils and in the machine itself.

To ensure a steady supply of soft water the water softener unit must always be:

1. correctly set (programmed) and
2. the salt reservoir must be filled.
(If the water hardness level is below 0.7 mmol/l (4 °d - German scale) the reservoir does not need to be filled with reactivation salt.)

The machine is set at the factory for a water hardness level of 3.4 mmol/l (19 °d).

If the water supply is harder or softer than this (including below 0.7 mmol/l or 4 °d) the factory setting will need to be changed following the instructions in "Setting the water softener". See chart on the next page for settings.

Your local water authority will advise you on the water hardness in your area.

For fluctuating levels (e.g. 1.4 - 3.1 mmol/l or 8 - 17 °d) set the water softener to the highest setting (in this example to 3.1 mmol/l or 17 °d).

Important

The built-in water softener has settings from 0.2 - 10.8 mmol/l or 1 °d - 60 °d.

Settings









°d (German scale)	mmol/l	°f	Setting
1	0.2	2	1
2	0.4	4	2
3	0.5	5	3
4	0.7	7	4
5	0.9	9	5
6	1.1	11	6
7	1.3	13	7
8	1.4	14	8
9	1.6	16	9
10	1.8	18	10
11	2.0	20	11
12	2.2	22	12
13	2.3	23	13
14	2.5	25	14
15	2.7	27	15
16	2.9	29	16
17	3.1	31	17
18	3.2	32	18
19 *)	3.4	34	19
20	3.6	36	20
21	3.8	38	21
22	4.0	40	22
23	4.1	41	23
24	4.3	43	24
25	4.5	45	25
26	4.7	47	26
27	4.9	49	27
28	5.0	50	28
29	5.2	52	29
30	5.4	54	30
31	5.6	56	31
32	5.8	58	32
33	5.9	59	33
34	6.1	61	34
35	6.3	63	35
36	6.5	65	36
37	6.7	67	37
38	6.8	68	38
39	7.0	70	39
40	7.2	72	40
41	7.4	74	41
42	7.6	76	42
43	7.7	77	43
44	7.9	79	44
45	8.1	81	45

°d (German scale)	mmol/l	°f	Setting
46	8.3	83	46
47	8.5	85	47
48	8.6	86	48
49	8.8	88	49
50	9.0	90	50
51	9.2	92	51
52	9.4	94	52
53	9.5	95	53
54	9.7	97	54
55	9.9	99	55
56	10.1	101	56
57	10.3	103	57
58	10.4	104	58
59	10.6	106	59
60	10.8	108	60

*) factory setting

Water softener

Setting the water softener

- Switch off the machine.
- Turn the programme selector to the STOP position .
- Press  and  at the same time, hold them in and, whilst doing so, switch the machine on with the I-0 button.
The current programme status "P.." will show in the display.
The indicator light  /  will come on.
- Press  once, E01 for programming level 1 will appear in the display.
- Turn the programme selector one switch position clockwise (1 o'clock position).
The number 19 appears in the display (the factory water hardness setting in °d), (equivalent to 3.4 mmol/l).
- Press  as many times as is necessary, or hold it in until the required value (hardness level in °d) appears in the display.
Once the number 60 has been reached, the counter will begin again at 0.
- Press the  button. SP will appear in the display.
- Press  again. The setting will now be stored in memory. The display will go out.
- The machine is now ready for use.

For future servicing it is useful to make a note of your water hardness level.

- Enter your water hardness level here:
_____ °d (German scale) or
_____ mmol/l

Filling the salt reservoir

Please only use special coarse grained reactivation salt with granules of approx. 1-4 mm. Do not use other types of salt, e.g. table salt, agricultural or gritting salt. These could contain components which are insoluble in water which could result in damage to the water softener. If in doubt consult your Miele Professional Department.

The salt reservoir holds approx. 2.5 kg of salt.

 Inadvertently filling the salt reservoir with cleaning agent will damage the water softener.

Before filling the salt reservoir make sure that you have picked up the right packet of reactivation salt.

- Remove the bottom basket from the machine.
- Unscrew the salt reservoir cap.

Before filling the salt reservoir with reactivation salt for the first time, fill it with approx. 2.5 litres of water.

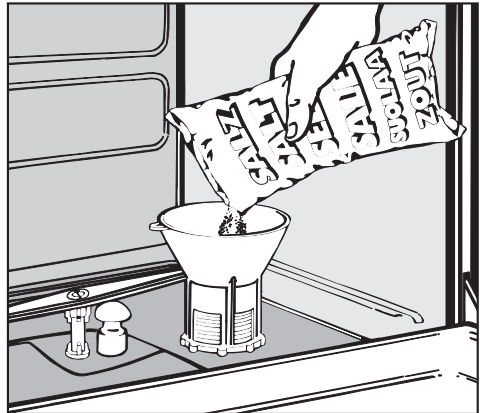

- Place the funnel provided in place.
- Fill carefully with salt. As it is filled, displaced water will run out).
- Wipe any residual salt off the screw threads on the socket.
- Screw the cap on firmly.
- Immediately after this: Run the PRE-RINSE programme 1 to remove any traces of salt from the cabinet.

Important: If after starting the PRE-RINSE programme 1 the machine does not start for a few minutes this is not a fault. The water softener is being reactivated.

Water softener

Salt indicator

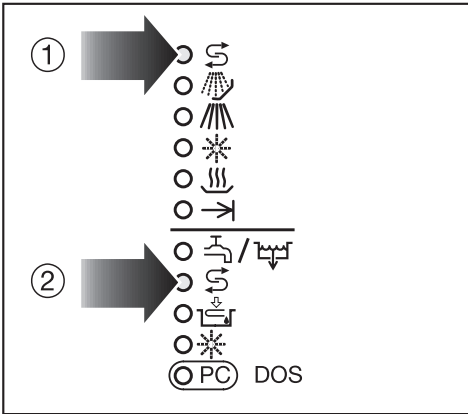

When the salt reservoir is empty the S indicator light ② comes on to remind you to fill the reservoir.

Reactivation takes place automatically during a programme.

The programme sequence indicator light S ① lights up whilst this is happening.

Adding rinsing agent

Important:

Both reservoirs must always be filled with the same liquid agent.

Setting the dosage

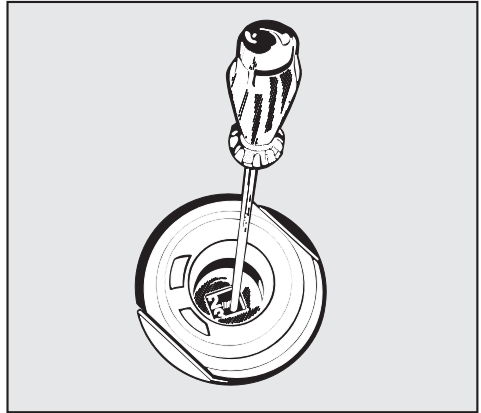



The dosage adjuster in both openings has settings from 1-6 (1-6 ml). It is set to "2" (4 ml) at the factory.

- Use a higher setting if there are marks on the surface of utensils after drying.
- Use a lower setting if the surface becomes cloudy and smeary.

Adding cleaning agent

 Only use cleaning agents suitable for washer disinfectors. Do not use detergents formulated for domestic dishwashers.

Liquid cleaning agents (mildly alkaline) should be dispensed via a DOS module (available as an optional extra - see the Note on the next page).

If liquid cleaning agent is not being used, powder cleaning agent must be placed in the detergent dispenser before every programme except with PRE-RINSE  and DRAIN .

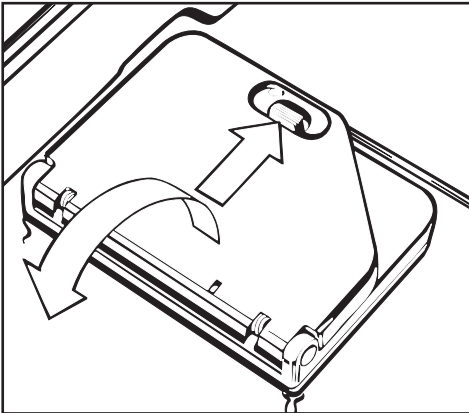

- Press the opening catch on the dispenser (see arrow) forwards. The lid will spring open. (The lid is always open at the end of a programme).

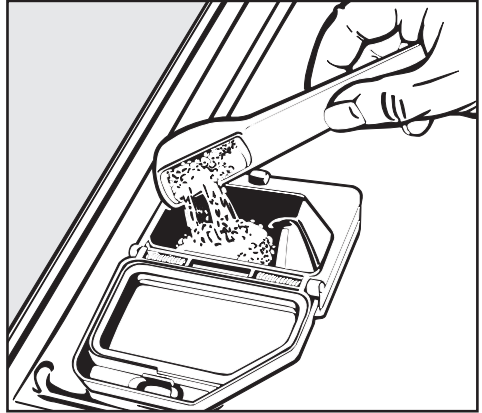

- Add powder cleaning agent to the compartment.

Dosage: Approx. 3 g/l, or 30 g per batch.

Approx. 10.5 litres of water are used in the wash programme sequence.

Follow detergent manufacturer's instructions if they differ.

- Close the dispenser lid.

Adding cleaning agent

Taking the effect on the environment into consideration, please bear the following points in mind when selecting a cleaning agent:

- What level of alkalinity is required to achieve the correct level of cleaning?
- Is active chlorine required for disinfection or oxydation (pigment removal)?
- Are tensides required, in particular for dispersal and emulsification?

Some types of soiling may require different combinations of cleaning agents and other additives. The Miele Professional Department will be pleased to advise you.

Note

As a chargeable optional extra this machine can also be fitted with a DOS-Module G 60 dispenser pump for liquid cleaning agent. This is connected externally.

See "Programming special functions" for venting the dispensing system and setting the dosage.

The optional DOS Module is supplied with its own installation and connection instructions.

Maintenance of the dispensing system

To ensure trouble-free operation the following regular maintenance should be carried out by a Miele approved service technician.

Every 12-18 months:

Replace the dispensing hoses in the DOS modules.

 Take care when handling liquid agents and additives. These may contain irritant or corrosive ingredients. Follow the manufacturer's safety instructions and relevant Health and Safety procedures carefully. Wear protective gloves and goggles.

Loading the machine

Preparing the load

- Empty all containers before loading into the machine.

 Ensure that no acid or solvent residues, especially hydrochloric acid or chlorides, get into the wash cabinet.

Please note

- Load items so that water will come into contact with all surfaces. This ensures that they will be properly cleaned.
 - Do not place items to be cleaned inside other pieces where they may be concealed.
 - Hollow vessels such as cups, glasses, pots etc. should be inverted and placed in the correct inserts. The water must be able to access them unhindered.
 - Deep-sided items should be placed at an angle so that water can run off them unhindered.
 - Tall, narrow, hollow items should be placed in the centre of the baskets to ensure better water coverage.
 - Small pieces should be placed on the cup racks in the upper basket. Do not obscure them by larger items below. Cups should be on the lower rack and bowls on the top rack so that water reaches all items.
- The water duct for the spray arm in the middle of the upper basket must not be obstructed.
 - The spray arms must not be blocked by items which are too tall or which hang down in their path. If necessary, manually rotate the arms to test.

Use the upper basket for:

- Small lightweight, delicate items such as cups, saucers, glasses, dessert bowls etc., as well as for lightweight thermally stable plastic items.

Use the bottom basket for:

- Larger and heavier items such as plates, serving platters, saucepans, bowls etc. Glasses may only be cleaned in the bottom basket if it is fitted with a special glassware insert or if there is a special bottom basket.

Cutlery

- Unsorted cutlery should be placed in the cutlery holders with the handles facing downwards. However, to avoid the risk of injury, sharp knives etc. should be placed with the pointed end facing downwards.

Select baskets and inserts which are appropriate for the application.

See examples on the following pages.

Loading the machine

Loading examples:

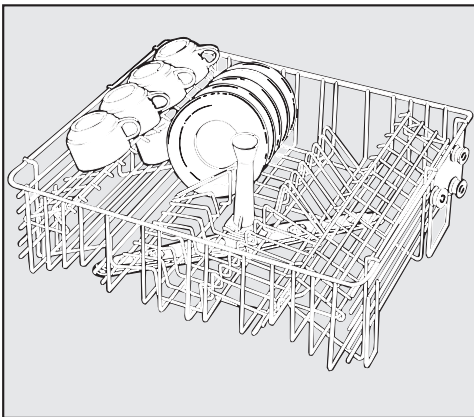

O 181 Top basket

for 20 cups, 24 saucers or 12 dessert plates.

Separate lower baskets

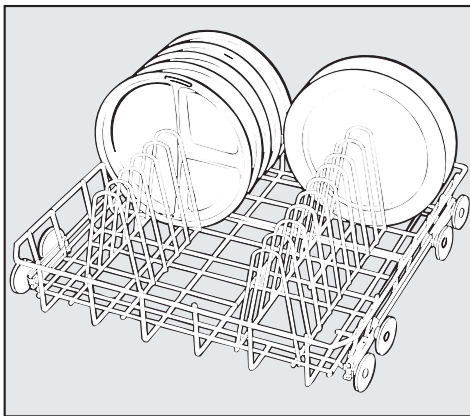

U 880 Bottom basket

with E 884 insert 1/1 for 20 large plates or 10 trays.

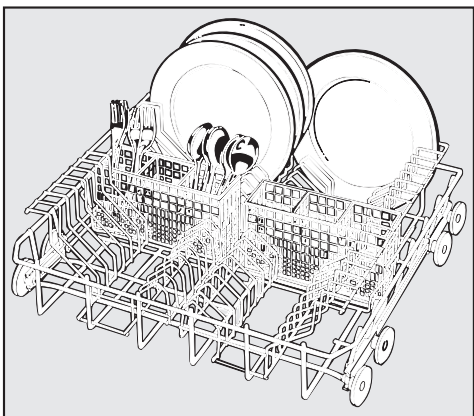

U 880 Bottom basket

with 2 x E 216 half inserts each for 15 plates Ø 240 mm and 2 x E 165 cutlery baskets for mixed cutlery.

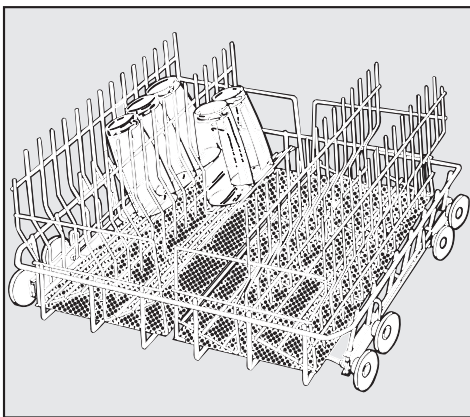

U 880 Bottom basket

with 2 x E 205 half inserts each for 14 glasses Ø 65 mm.

Adjusting the top basket

The top basket can be adjusted above and below the middle position by 2.5 cm. It is set in the middle position at the factory.

Depending on the position of the top basket, plates of the following diameter can be accommodated in the baskets:

Example: Top basket O 181

Top basket position	Top basket plate Ø in cm	Bottom basket plate Ø in cm
Top	max. 16.5	24 *)
Middle	max. 19	24 *)
Bottom	max. 21.5	24 *)

*) in insert E 216. For plates up to Ø 30 cm, use insert E 888.

To adjust the top basket:

- Pull out the top basket until a resistance is felt; lift from the runners and remove.
- Unscrew the knurled nuts (roller bearings) on both sides of the basket with a suitable spanner and reposition as required.

Items not suitable for dishwashers

- Cutlery with wooden or horn handles.
- Wooden or plastic chopping boards.
- Glued items, e.g. old knives with handles which have been glued on.
- Hand-made craft items.
- Copper or tin items.
- Plastic items which are not heat resistant.

Please note

- Silver and aluminium items can suffer some discolouration.
- Colours painted over a glaze may fade after a number of washes.
- Clouding may occur on glasses after frequent washing.

Our recommendations







- Wash delicate glassware by hand.
- When purchasing new glasses, dishes and cutlery make sure they are dishwasher safe.

Selecting a programme

Choose your programme according to the type of instruments or utensils being cleaned, and the degree of soiling.

The different programmes and their uses are described overleaf in the **Programme chart**.

Programme chart

Programme	When to use	Powder cleaning agent (when not using liquid cleaning agent)
		Follow manufacturer's instructions
 SHORT	Quick programme for lightly soiled crockery.	30 g in the powder dispenser
 UNIVERSAL	For normally soiled loads.	30 g in the powder dispenser
 INTENSIVE	For heavily soiled crockery. Most of the soiling is removed in an intensive cold-water pre-rinse.	30 g in the powder dispenser
 PRE-RINSE	To rinse heavily soiled items, (e.g. for removing soiling or to prevent soiling drying on to dishes when a complete programme does not yet need to be run).	
 DRAIN	For draining water out of the machine, e.g. when a programme has been interrupted. Turn the programme selector to the STOP position  first.	

Programme sequence						
Pre-wash 1	Pre-wash 2	Main wash 1) ¹⁾	Rinse	Rinse	Final rinse 1) ¹⁾	Drying (Additional function)
	KW	WW 65°C/1' DOS 1			WW 85°C/1' DOS 2	(X)
	KW	WW 65°C/1' DOS 1	WW		WW 85°C/1' DOS 2	(X)
KW	KW	WW 65°C/3' DOS 1	WW		WW 85°C/1' DOS 2	(X)
				KW		

¹⁾ To change a temperature or temperature holding time see "Programming special functions".

KW = Cold water

WW = Hot water (with temperature/temperature holding time)

DOS 1 = For dispensing cleaning agent

DOS 2 = For dispensing rinsing agent

Operation

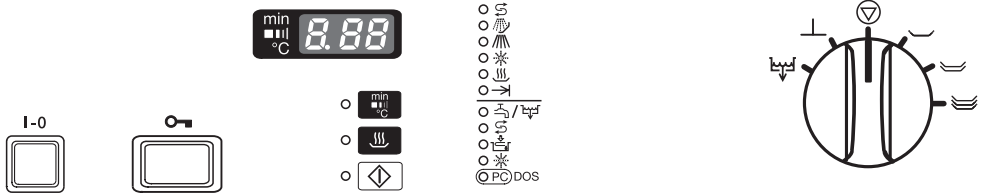





Switching on

- Close the door.
- Open the stopcocks (if turned off).
- Press the **I-0** button.

When the programme selector is at the STOP position  a point lights up in the display field.

Starting a programme

- Turn the programme selector clockwise or anti-clockwise to the required programme.
The temperature of the first wash of the programme selected is shown in the display, except with  (PRE-RINSE) and  (DRAIN).
The indicator light next to the Start button  flashes.
- Select additional function DRYING  if required (see "Selecting an additional function").
- Press the Start button . The actual temperature will appear in the display.
The indicator light next to the Start button lights up constantly.

Once the programme has started all other programmes are blocked. If the programme selector is then turned to another programme, the values shown in the display go out. The values can be seen again if the programme selector is turned back to the position of the programme currently in operation.



- During a programme, the  button can be used to toggle between displaying the actual time, the elapsed time and the active wash block*).

*) depending on model:

- 1 = Pre-wash 1
- 2 = Pre-wash 2
- 3 = Main wash 1
- 4 = Main wash 2
- 5 = Chemical disinfection
- 6 = Rinse 1
- 7 = Rinse 2
- 8 = Rinse 3
- 9 = Rinse 4
- 10 = Final rinse 1
- 11 = Final rinse 2
- 12 = Drying TA
- 13 = Drying



Changing a programme

Provided the Start button has not yet been pressed, a wrongly selected programme may be changed as described below (if it has been pressed, see "Cancelling a programme"):

- Turn the programme selector to the required programme.
- Select additional function DRYING  again if required (see "Selecting an additional function").
- Press the Start button .







Selecting an additional function

The following additional function can be selected:



-  DRYING may be selected as an additional function as soon as the programme has been selected (except with  PRE-RINSE and  DRAIN). Drying is phased over 10 minutes. The total running time of the programme lengthens accordingly.

Programme sequence display

The indicator light for the active programme stage lights up during the programme.

	Reactivation
	Pre-wash
	Main wash
	Interim rinse / Final rinse
	Drying (additional function)
	End of programme (Programme parameters have been reached)

Programme end

The programme has ended when  lights up constantly in the programme sequence display and the Start indicator light  has gone out. A "0" appears in the middle of the display. All the other indicator lights come on and go out in sequence. At the same time a buzzer sounds for a maximum of 30 seconds (standard setting). The buzzer can be changed (see "Programming special functions").

Use the  button to call up the total running time of a programme or the actual temperature.

Switching off

- Press and release the **I-0** button.



Note:

As the machine is fitted with an electro-thermal door lock, the door can only be opened if the **I-0** button is pressed in (see "Opening and closing the door").

Operation

To cancel a programme

Once a programme is running it should only be cancelled in extreme cases, e.g. when articles in the machine rattle or jostle against each other and have to be rearranged.

- Turn the programme selector to the  position (the programme is cancelled after approx. 2 secs.).
- Open the door 

 Caution. Water and items in the machine may be hot. Danger of burning or scalding.

- Arrange the load securely, (wear protective gloves where necessary, and observe appropriate health and safety regulations relating to infectious diseases).
- Replenish powder detergent if necessary.
- Close the door.
- Select the DRAIN programme , (wash liquor is pumped away).
- Select and start the programme again.







For future servicing work, please document any alterations to the standard factory settings.

Enter any alterations in the field Value set: _____.

General notes:

- Switch positions that have not been allocated a function are indicated in the middle part of the display by a bar (-).
- The programming level is called up via the STOP position .
- A number of **global parameters** and **programme specific parameters** can be altered.
Settings and alterations to global parameters (setting concentration levels for DOS 1) **apply to all programmes** in which the parameter is found.
Setting and altering programme specific parameters (Wash/Rinse temperatures and temperature holding times: Main wash and Final rinse) **only applies to the programme** in which this parameter is found.

1. Setting the dosage concentration and venting the dispensing system

- Turn the programme selector to STOP .
- Switch off the machine.
- Press and hold  and  at the same time, and whilst doing so, switch the machine on with the **I-0** button.
The current programme status "P..." will appear in the display and the  /  indicator light will come on.
- Press  twice, E02 for programming level 2 will appear in the display.

Programming special functions

1.1 DOS 1 (liquid cleaning agent) via the optional DOS-Module G 60 or C 60.



1.1.1 Setting the dosage

concentration (global parameter):

- Set the dosage selector on the DOS module to position 10 (applies to DOS Module C 60 only).

Set the concentration level according to the cleaning agent manufacturer's recommendations.



Example: If the manufacturer recommends a concentration level of 0.5% A value of 0.50 should be set.

- Turn the programme selector to . The display will show either the dosage time in seconds for cleaning agent dispensed via the dispenser for powder detergent in the door, or the dosage concentration for liquid cleaning agent as a %:
10 = Dosage via the door dispenser (10 sec) or 0.10 - 1.00 = 0.1% -1% dosage concentration.
- Press  as many times as necessary or hold it pressed in until the required value appears. The dosage time / dosage concentration is now set.



Value set: _____

1.1.2 Venting the dispensing system:



a) After setting the dosage concentration:

- Turn the programme selector to the  position. do1 appears in the display.
- Press . The dispensing system will be vented automatically. do1 will appear in the display when venting is finished.

Having changed a value or all values:

- Press . SP appears.
- Press  again. The change has been recorded.
- b) If venting only is required (e.g. because the dispensing system has been allowed to empty by mistake)
- Select programming level 2 (see **1.**).

Then proceed as follows:

- Turn the programme selector to the  position. do1 appears in the display.
- Press . The dispensing system will be vented automatically. do1 will appear in the display when venting is finished.
- Switch the machine off with the **I-0 button**.

Every time the dispensing system has been vented:



- Run the PRE-RINSE programme  so that after venting any agents in the wash cabinet are diluted before being drained away.



2. Altering the wash/rinse temperature and/or the temperature holding time in the "Main wash" and "Final rinse" programme stages

Please make a note of any changes to the temperature and / or the temperature holding time in the appropriate section of the [programme chart](#).



The programme chart shows the factory settings for the [Main wash temperature](#) together with temperature holding time and the [Final rinse temperature](#) with its temperature holding time.

The special functions can be used to alter the temperatures of the main wash and of the final rinse from 30 °C - 93 °C and the temperature holding time from 1-15 minutes.



- Turn the programme selector to STOP .
- Switch off the machine.
- Press and hold  and  at the same time, and whilst doing so, switch the machine on with the **I-0** button.

The current programme status "P..." will appear in the display and the  /  indicator light will come on.

“Main wash” temperature (programme specific parameter):



- Press  as often as necessary or hold it pressed in until E09 (programming level 9) appears in the display.
- Turn the programme selector to the programme which needs to be changed. The current value appears in the display after **°C**.
- Press  or hold pressed in until the required value appears in the display.

Main wash temperature holding time (programme specific parameter):



- Turn the programme selector to STOP .
- Press  as often as necessary or hold it pressed in until E10 (programming level 10) appears in the display.
- Turn the programme selector back to the programme which needs to be changed. The current value appears in the display after **min**.
- Press  or hold pressed in until the required value appears in the display.

Programming special functions



Final rinse temperature (programme specific parameter):

- Turn the programme selector to STOP .
- Press  as often as necessary or hold it pressed in until E25 (programming level 25) appears in the display. Then:
- Turn the programme selector to the programme which needs to be changed. The current value appears in the display after **°C**.
- Press  or hold pressed in until the required value appears in the display.

Final rinse temperature holding time (programme specific parameter):







- Turn the programme selector to STOP .
- Press  as often as necessary or hold it pressed in until E26 (programming level 26) appears in the display. Then:
- Turn the programme selector back to the programme which needs to be changed. The current value appears in the display after **min**.
- Press  or hold pressed in until the required value appears in the display.

Having changed a value or all values:



- Press . SP appears.
- Press  again. The change has been recorded.

3. Audible tone (Buzzer)

This special function allows you to programme a buzzer (lasting up to a maximum of 30 seconds) for the following functions:

- Programme end = Constant buzzer
- Fault warning = Buzzer at one second intervals
- Removing a test item from the final rinse water (this function has to be programmed by a Miele service engineer)
= 3 x short beeps followed by 2 second pause, then 3 short beeps etc.
- Turn the programme selector to STOP .
- Switch off the machine.
- Press and hold  and  at the same time, and whilst doing so, switch the machine on with the **I-O** button.
The current programme status "P.." will appear in the display and the  /  indicator light will come on.
- Press  four times. E04 (programming level 4) appears in the display.
- Turn the programme selector to . A number from 20 to 27 will appear in the display.
20 = Buzzer switched off
21 = Buzzer at end of programme (standard setting)
22 = Fault indication
23 = Fault indication and buzzer at end of programme
24 = Reminder to remove a test item

25 = Buzzer at end of programme and for removing a test item
26 = Fault indication and buzzer for removing a test item
27 = Buzzer for all functions (Programme end, Fault indication, Removing a test item).

- Press  or hold pressed in until the required value appears in the display.
- Press . SP appears.
- Press  again. The change has been recorded.

Value set: _____









Note:

The buzzer can be switched off early by

- turning the programme selector to the STOP position ,
- pressing the  button, or
- interrupting the power supply (e.g. by opening and closing the door).

Programming special functions

4. Re-setting all parameter changes back to the factory settings.

- Turn the programme selector to STOP .
- Switch off the machine.
- Press and hold  and  at the same time, and whilst doing so, switch the machine on with the **I-0** button.
The current programme status "P.." will appear in the display and the  /  indicator light will come on.
- Press  as often as necessary or hold it pressed in until E33 (programming level 33) appears in the display.
- Turn the programme selector to any switch position (except STOP).
00 or PP will appear in the display.
00 = factory setting
(Electronics have not been re-programmed).
PP = Electronics have been re-programmed.
- If PP is displayed, press  to change from PP to 00.
- Press . SP appears.
- Press  again. All values which had been changed have now been now reset to the factory settings.

When restoring all changed values, please note

that any new setting for the water hardness level also reverts to the factory setting of 19 °d (3.4 mmol/l).

The final rinse temperature of 85°C/1' is now 93°C/3'.

Re-setting is required in both cases.

Cleaning the filters in the wash cabinet

 This machine must not be used without all the filters in place.

The filter combination in the base of the wash cabinet should be inspected regularly and cleaned if necessary.

 **Caution**
Watch out for glass splinters which could cause injury.

Cleaning the coarse filter

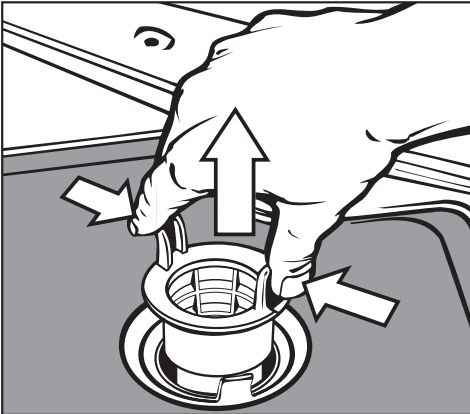

- Press the two lugs together, remove and clean the coarse filter.
- Put the clean filter back in position and press until it clicks in place.

Cleaning the fine, flat and micro-fine filters

- Remove the coarse filter.
- Remove the fine filter (if fitted) from between the flat and the micro-fine filters.

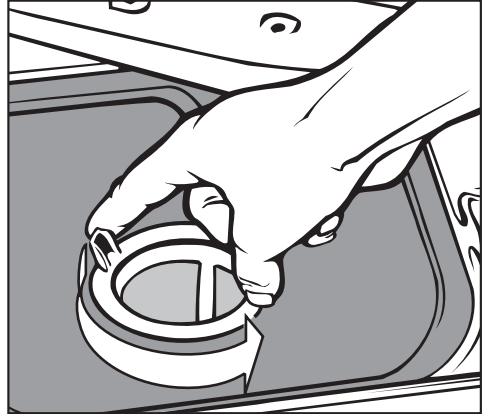

- To unscrew the micro-fine filter, take hold of the two lugs and turn twice in an anti-clockwise direction.

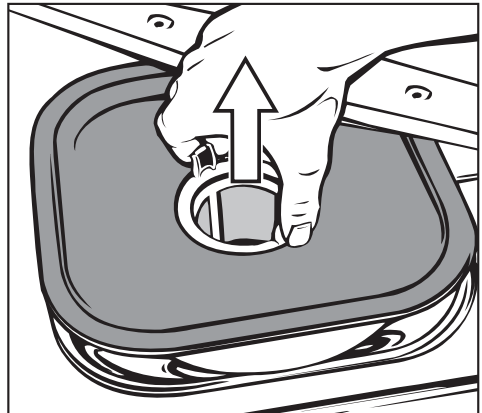

- Then remove together with the flat filter.
- Clean the filters.
- Replace the filter combination by carrying out the above steps in the reverse order. Ensure that the flat filter sits flat in the base of the wash cabinet.

Cleaning and care

Cleaning the spray arms

Waste particles can lodge in the spray arm jets.

It is therefore important to inspect the spray arms regularly.

- Use a sharp pointed object to push particles into the spray arm jets and rinse well under running water.

Remove the spray arms as follows:

- Unscrew the **upper** spray arm.
- Remove the **middle** spray arm by unscrewing the nut which secures it to the upper basket.

Important: The nut has a left hand thread and has to be turned clockwise to unscrew it.

- Loosen the knurled thumb nut to unscrew the **lower** spray arm. You will first need to take the bottom basket out of the machine.

Important:

After replacing the spray arms, check that they rotate freely.

Cleaning the drain pump and non-return valve

If water has not been pumped away at the end of a programme the drain pump or the non-return valve might be blocked. They are however, easy to clean.

- Take the filter combination out of the wash cabinet.

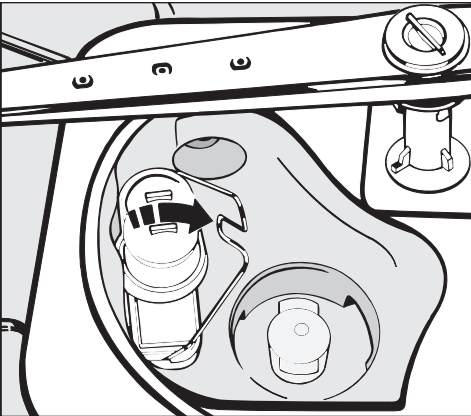

- Release the locking clamp.
- Lift up the non-return valve and rinse under running water.

The drain pump is situated under the non-return valve (see arrow).

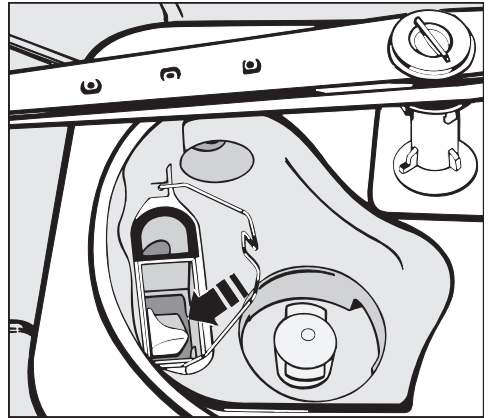

- Before replacing the non-return valve check that the drain pump is free of obstructions.
- Carefully replace the non-return valve and secure with the locking clamp.

For safety reasons you should clean the load again.

Cleaning and care

Cleaning the filters in the water inlet

Filters are incorporated in the screw connection of the water inlet hose to protect the water inlet valve. If these filters get dirty they need to be cleaned, otherwise insufficient water flows into the wash cabinet.

 The plastic housing of the water connection contains an electrical component. It must not be dipped in water.

To clean the filters

- Disconnect the machine from the mains supply (switch off at the mains and pull out the plug, switch off the appropriate circuit in the fuse box or withdraw the mains fuse).
- Turn off the stopcock and unscrew the water inlet hose.

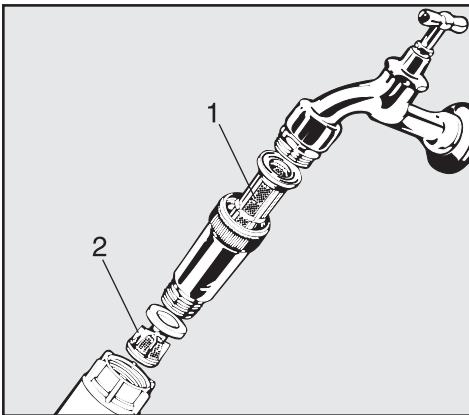

- Clean the large area filter (1) and fine filter (2), and replace with new filters if necessary.

- Replace filters and the seal. Make sure they are sitting correctly.
- Reconnect the hose to the water inlet, making sure that it goes back on straight.
- Open the stopcock carefully. If there is a leak, screw the connections on more tightly.

Cleaning the control panel

- This should only be cleaned with a damp cloth or a suitable cleaner for use on plastic materials, or with a disinfectant tested and recognised as suitable for this use.

 Do not use abrasive cleaners, glass cleaners or all-purpose cleaners!
Because of their chemical composition they could cause serious damage to plastic components.

Cleaning the front of the machine

- Clean using a proprietary cleaning agent designed for the type of front the machine is fitted with.

 Do not use cleaning agents containing ammonia or thinners.

With the aid of the following explanatory notes, minor faults can be corrected without contacting the Miele Service Dept.

Any work on the electrical components of the machine should only be carried out by a suitably qualified and competent person in accordance with local and national safety regulations. Unauthorised repairs could be dangerous.

Faults / possible causes

The machine does not start

- The door is not properly closed.
- The plug is not properly inserted in the socket.
- The fuse is defective / has blown.

A few minutes after switching on, the / indicator light flashes (fault code F.E appears in the display)

- The stopcocks are closed.
- The filters in the water inlet hose are dirty.
- The water pressure is too low.
- Turn the programme selector to the STOP position  (the fault code goes out).
- Switch the machine off (press **I-0**).
- Open the stopcocks or clean the filters (see "Cleaning and Care").
- Switch the machine on again and reselect the programme.

The wash cycle finishes too early and the / indicator light flashes (fault code F A appears in the display)

- The drain hose is kinked.
- The drain pump is blocked
- Turn the programme selector to the STOP position  (the fault code goes out).
- Switch the machine off (press **I-0**).
- Straighten the hose and check/clean the drain pump.
- Switch the machine on again, drain the water away and start the programme again (see DRAIN and "Switching on").

Water in the wash cabinet does not heat up; the programme takes too long (fault code: F01 - F03, F18, F19 appears in the display).

This machine has a resettable heater limiter which will switch off the heaters if they over-heat. This could be caused for example, by large articles covering the heating elements or if the filters in the wash cabinet are blocked.

- Remove the cause of the fault.
- Take off the service panel (see "Electrical connection").
- Press the reset button on the heater limiter (reddish brown) located on the left- hand side of the plinth.

If this switch trips again contact the Miele Service Department.

Correcting minor faults

After sales service

Important:

When a fault first occurs, please check that the fault has not been caused by incorrect operation. This will help avoid an unnecessary service call-out. To do this:

- Turn the programme selector to the STOP position (⏏) (the fault code goes out).
- Switch the machine off (press **I-0**).
- Switch the machine on again and reselect the programme.

If you still have difficulties or if a fault code "F..." appears in the display, please contact your authorised Service Dealer or the Miele Service Department. See back cover for addresses.

Please quote the fault code as well as the model type and number of your machine which is given on the data plate (see "Electrical connection").

Please refer to the installation diagram supplied with the machine.

 Furniture and fittings installed near the machine must be of a commercial standard able to withstand the effects of steam and condensed water.

The machine must be installed correctly and levelled.

Any unevenness in the floor level can be compensated for and the height of the machine raised or lowered by adjusting the four screw feet.

The machine can be installed in the following ways:

■ Free-standing.

■ Slot-in or at the end of a row:

The machine can be installed next to other machines or furniture or in a suitable niche. The niche must be at least 60 cm wide and 60 cm deep.

■ Built-under:

The machine can be installed under a continuous worktop or sink drainer. The recess must be at least 60 cm wide, 60 cm deep and 82 cm high.

If necessary, the machine lid can be removed as follows:

■ Open the door.

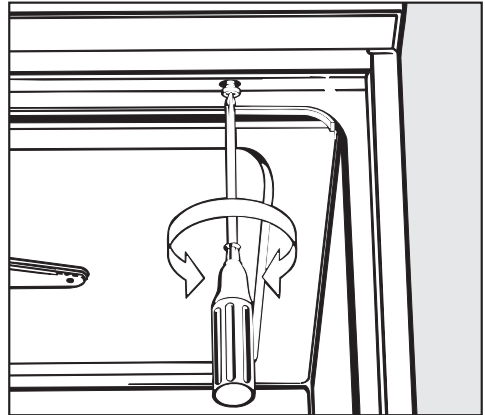

■ Remove the fixing screws on the left and right hand sides using a cross slotted screwdriver.

■ Pull the machine lid approx. 5 mm forwards, lift it upwards and remove it.

Important for machines fitted with a steam condenser (depending on model):

To prevent damage by steam to the worktop, the self adhesive protective foil supplied (25 x 58 cm) must be stuck in place underneath the worktop near the steam condenser.

Installation

Position and secure the machine

To ensure stability the machine must first be aligned and then screwed to the worktop.

- Open the door. Secure the machine to the front edge of the worktop using screws through the holes on the left and right hand sides of the front trim.
- Do not use silicone sealant to seal the gaps between the machine and any neighbouring units as this would hinder ventilation to the circulation pump.

Depending on the requirements for building under, the following kit can be ordered from the Miele Spares Dept.:

Cover plate (protects the worktop)

The underside of the worktop is protected against water damage by a stainless steel plate.

Decor frame and decor panel (optional)

If you wish to fit a decor panel to the machine this can only be done by a Miele Service technician. Contact Miele for details.

Decor panel dimensions:

Door panel H x W: 442/586 mm

Service panel H x W: 117/586 mm

 All electrical work must be carried out by a suitably qualified and competent person in accordance with local and national safety regulations.

- Connection should be made via a suitable isolator, with an on-off switch which should be easily accessible for servicing work.
- For extra safety it is advisable to install a residual current device with a trip current of 30 mA (in accordance with DIN VDE 0664).

WARNING

THIS APPLIANCE MUST BE

EARTHED

- Equipotential bonding should be carried out.

Bonding connection

There is a screw connection point marked with the earth symbol () at the back of the machine, to which the earth lead must be connected.

- For technical data see data plate or wiring diagram supplied.

The machine must only be operated with the voltage, frequency and fusing shown on the data plate.

This machine **can be converted** in accordance with the conversion diagram and wiring diagram supplied.

The conversion diagram and data plate with test certification (VDE, DVGW etc.) is located on the rear of the machine, and on the plinth (behind the service panel).

The wiring diagram is secured to the inner side of the service panel.

To remove the service panel and plinth:

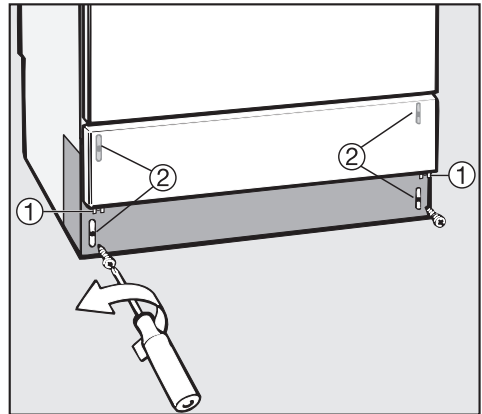

 Disconnect the machine from the mains electricity supply.

- Remove fixing screws ① from the service panel.
- Take hold of the service panel at both sides and pull upwards.
- Unscrew plinth facing (screws ②).
- Remove the plastic protective cap.

Electrical connection



To re-assemble:

- Refit the plastic protective cap, plinth facing and service panel in the reverse order to which they were removed.

See also the installation diagram supplied.

Connection to the water inlet

 Water in the machine must not be used as drinking water.

- The machine must be connected to the water supply in accordance with local and national water authority regulations.
- This machine is constructed to comply with German water regulations (DVGW), and may be connected to a suitable supply without an extra non-return valve if national regulations permit.
- The water pressure (flow rate) must be a minimum of 0.5 bar (50 kPa). If the water pressure (flow rate) is below 2 bar (200 kPa), the filling time is automatically extended. The max. permitted static pressure is 10 bar (1000 kPa). If the water pressure is not in the range of 0.5 to 10 bar (50-1000 kPa), the  /  indicator light may come on and the fault code "F.E" will show in the display. Please contact the Miele Service Department.
- The machine is supplied as standard for connection to a cold (coded blue) and a hot (coded red) water supply up to a max. temperature of 70 °C. The inlet hoses should be connected to the stopcocks for the hot and cold water supplies. The steam condenser inlet hose (without waterproof connector) should be connected to the cold water stopcock. If there is no hot water connection, the hot water inlet hose marked red

should also be connected to a cold water stopcock.

- Stopcocks with 3/4 BSP male thread are to be provided on site. They should be easily accessible so that the water supply can be turned off when the machine is not in use.
- The DN 10 inlet hoses are approx. 1.7 m long terminating in a 3/4 inch female thread. On no account must the inlet filters be removed.
- Large surface area filters are enclosed in the kit supplied with the machine for installing between the stopcock and the inlet hose (see illustration in "Cleaning and Care - Water inlet").

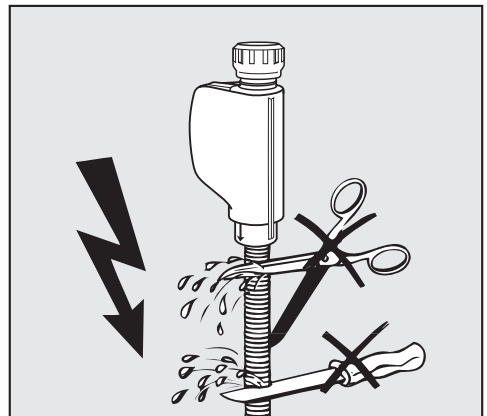

 The inlet hoses must not be shortened or damaged in any way (see illustration).

See also the installation diagram supplied.

Plumbing

Drainage

This machine is fitted with two drainage hoses. One hose is designated for dirty water; the other for water emitted by the steam condenser.

The drainage system is fitted with a non-return valve which prevents dirty water from flowing back into the machine via the drain hose.

- The machine should preferably be connected to a separate drainage system on-site.
If separate drainage is not available, contact your Miele application specialist for professional advice.
The on-site drain connection point should be sited between 0.3 m and 1 m above the lower edge of the machine.
If it is lower than 0.3 m, lay the hose in a curve at a height of at least 0.3 m.
The drainage system must be able to take a minimum drainage flow of 16 l/min.
- The drain hoses are approx. 1.4 m long, flexible and have an internal diameter of 22 mm. They must not be shortened.
Hose clips are supplied for securing them in position.
- Longer drain hoses (up to 4 m long) are available to order from the Miele Spare Parts Dept.
- The drainage system must not exceed 4 metres.

See also the installation diagram supplied.

Technical data

Height:	85 (82) cm
Width:	60 cm
Depth:	60 cm
Voltage:	see data plate
Rated load:	see data plate
Fuse rating:	see data plate
Mains connection cable:	approx. 1.8 m
Water pressure (flow rate): (0.5 - 10 bar) pressure	50 - 1000 kPa
Cold / hot water inlet connections:	up to max. 70 °C
Delivery head:	min. 0.3 m, max. 1 m
Drainage length:	max. 4 m
Inlet hose:	approx. 1.7 m
Drain hose:	approx. 1.4 m
Steam condenser:	approx. 2 l/min
Noise level in dB (A): Sound level LpA	Free standing: <70 Built under: <70
Test marks:	DVGW (German association of gas and water engineers)

United Kingdom:

Miele Co. Ltd.
Fairacres, Marcham Road
Abingdon, Oxon, OX14 1TW
tel. Abingdon (01235) 554455
Service Office: (01235) 554466
fax (01235) 554477
Internet: www.miele.co.uk

Ireland:

Miele Ireland Ltd.
Broomhill Road, Tallaght, Dublin 24
Tel: (01) 46 10 710, Fax: (01) 46 10 797
Email: info@miele.ie
Internet: <http://www.miele.ie>

Australia:

Miele Australia Pty. Ltd.
A.C.N. 005635398
1 Gilbert Park Drive
Knoxfield, VIC 3180
Telephone: (03) 9764 7100
Fax: (03) 9764 7129
Internet: www.miele.com.au

Distributor New Zealand:

Steelfort Engineering Company. Ltd.
500 Rangitikei Street
Palmerston North, Priv. Bag 11045, NZ
Telephone: (06) 350 1350
Fax: (06) 356 1507

South Africa:

Miele (Pty) Ltd
63 Peter Place
Bryanston 2194
P.O. Box 69434
Bryanston 2021
Tel.: (011) 548 1900
Telefax (011) 548 1935
Internet: www.miele.co.za
E-mail: info@miele.co.za

Singapore:

Miele Southeast Asia
Miele Pte. Ltd.
163 Penang Road
04 - 02/03 Winsland House II
Singapore 238463
Tel : +65-67351191
Fax: +65-67351161
Email: mielesea@miele.com.sg

Hong Kong:

Miele (Hong Kong) Limited
AIA Plaza, Room 401, 4th Floor
18 Hysan Avenue
Causeway Bay
Hong Kong
Tel.: (852) 2610 1331
Fax: (852) 2610 1013
E-mail: mielehk@netvigator.com

Free Manuals Download Website

<http://myh66.com>

<http://usermanuals.us>

<http://www.somanuals.com>

<http://www.4manuals.cc>

<http://www.manual-lib.com>

<http://www.404manual.com>

<http://www.luxmanual.com>

<http://aubethermostatmanual.com>

Golf course search by state

<http://golfingnear.com>

Email search by domain

<http://emailbydomain.com>

Auto manuals search

<http://auto.somanuals.com>

TV manuals search

<http://tv.somanuals.com>